

CATALOGO

57



for a **safe** industry

 **Cartelli
Segnalatori**

- 20.000 ARTICOLI TRA CUI SCEGLIERE
- AMPIA DISPONIBILITÀ DI MAGAZZINO
- PRODOTTI STANDARD E PERSONALIZZATI
- SUPPORTO TECNICO NORMATIVO
- SERVIZIO RICERCA PRODOTTI

**DUE MARCHI
CON UN SOLO
OBIETTIVO:
LA VOSTRA
SICUREZZA**



Cartelli Segnalatori



for a **safe industry**

NUOVO CATALOGO 57!

Lo so! Non è una foto nell'ambito professionale, ma mi serve per farvi capire quanto **impegno, entusiasmo e positività** abbiamo messo in questo nuovo catalogo e metteremo nel prossimo futuro! Il nuovo catalogo ovviamente, il numero **57!** Sempre più aggiornato più ricco di informazioni e di foto, all'avanguardia con un **assortimento** per tutto il settore della sicurezza e non solo. Alcuni esempi: abbiamo ampliato l'offerta del pronto soccorso, inserito nuovi cartelli a norma, prodotti per la prevenzione degli allagamenti, una nuova gamma di lampade e torce, nuovi DPI, introdotto gli esoscheletri e molto altro ancora. Abbiamo instaurato un rapporto più stretto con molti dei nostri fornitori, sia per quanto riguarda i prodotti che per il servizio in termini di tempi ed assistenza post-vendita. Sotto il cappello SafeIn® abbiamo rivisitato tutte le nostre scorte, abbiamo investito molto, al fine di darvi una **disponibilità di prodotti** maggiore e conseguentemente una prontezza di risposta alle vostre richieste, dove la componente "tempo" è sempre più importante. Non ci accontentiamo più di essere efficaci, di produrre un risultato, ma vogliamo privilegiare sempre più l'**efficienza**, vale a dire, dare un risultato con tempi prestabiliti ed il più possibile brevi ed immediati. **Servizio, servizio, servizio!** Per far tutto questo abbiamo rimesso prepotentemente le **persone** "al centro", la loro crescita personale e professionale, la loro formazione e la condivisione di obiettivi e di una visione del nostro lavoro come una missione per un mondo migliore, più sereno e con meno incidenti sul lavoro. Siamo sicuri del nostro successo e speriamo con queste poche righe di aver coinvolto **anche voi** e avervi al nostro fianco in questo percorso di crescita e sviluppo.



Cesare Lucca
Presidente

CONTATTI



UFFICIO VENDITE

☎ **02.903990.01**

✉ **cs@cartelli.it**



338.59.27.471

**SCRIVICI SU WHATSAPP,
TI RISPONDEREMO IL
PRIMA POSSIBILE!**

UFFICIO TECNICO

☎ +39.02.903990.12 | ✉ **tec@cartelli.it**

AMMINISTRAZIONE

☎ +39.02.903990.66/18 | ✉ **coge@cartelli.it**

DESIGN & SYSTEM

☎ +39.02.903990.65 | ✉ **ds@cartelli.it**

ORARI UFFICI

Dal Lunedì al Venerdì: mattino 8.30 - 12.30 / pomeriggio 13.30 - 17.30

DOVE SIAMO

viale Alessandro Volta, 1 - 20047 Cusago (MI)

SEGNALETICA



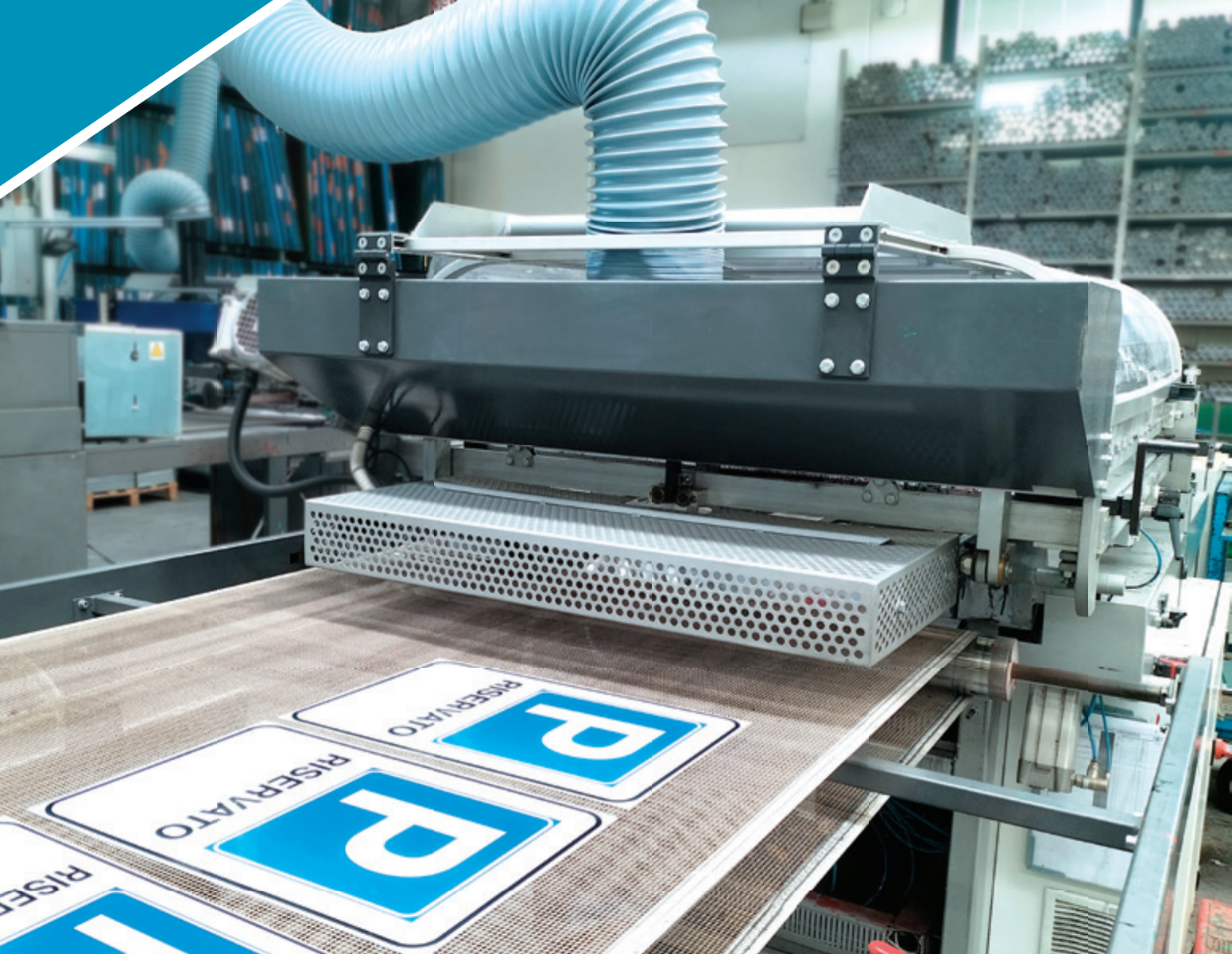

La nostra segnaletica viene prodotta con materiali di prima scelta. Le tinte degli inchiostri della stampa, con pigmenti dall'elevata resistenza alla luce, garantiscono una maggiore durata del segnale anche all'esterno e in condizioni estreme. Dimensioni e caratteristiche cromatiche e colorimetriche dei segnali sono conformi alle normative vigenti. Tolleranza dimensionale dei materiali: ± 1 mm. Tolleranza distanza di lettura: $\pm 2\%$.

IL CATALOGO



GUIDA ALLA SCELTA DEGLI ASSORBENTI



COLORI E CATEGORIE

UNIVERSALI (COLORE GRIGIO)

- Adatto per tutti i tipi di liquidi e olii.
- Assorbente e impermeabile.
- Resistente agli acidi e alcali.
- Non infiammabile.
- Non tossico.
- Non irritante.
- Non nocivo.
- Non inquinante.
- Non interferisce con i processi di smaltimento.

OLEOBASSORBENTI (COLORE BIANCO)

- Specifico per olii e grassi.
- Assorbente e impermeabile.
- Resistente agli acidi e alcali.
- Non infiammabile.
- Non tossico.
- Non irritante.
- Non nocivo.
- Non inquinante.
- Non interferisce con i processi di smaltimento.

CHIMICI (COLORE BIANCO)

- Specifico per liquidi chimici.
- Assorbente e impermeabile.
- Resistente agli acidi e alcali.
- Non infiammabile.
- Non tossico.
- Non irritante.
- Non nocivo.
- Non inquinante.
- Non interferisce con i processi di smaltimento.

FORMATI ED APPLICAZIONI

SALICOTTI

BARRE

PANNI

ROTOLI

CUSCINI

KIT



Vi proponiamo la più ampia gamma di prodotti per la sicurezza sul lavoro, con più di 20.000 referenze tra cui scegliere. Un catalogo costantemente aggiornato con prodotti selezionati da un team di esperti tra i migliori marchi del settore. Descrizioni tecnico/normative estremamente accurate ed affidabili. Un valido strumento di lavoro che vi accompagna quotidianamente nella scelta delle soluzioni più idonee alle varie realtà lavorative.

IL MAGAZZINO



Ampia disponibilità di prodotti a magazzino. Evadere un ordine in tempi brevi è una delle nostre priorità. Per questo motivo, il nostro ampio magazzino (8.000 m² coperti, 3.400 m² scoperti divisi tra produzione e magazzino) gestisce efficacemente le circa 20.000 referenze presenti a catalogo. **Un efficace sistema di approvvigionamenti** e efficienza logistica per fornirvi un servizio puntuale e veloce.

RICERCA PRODOTTI



Se non trovate il prodotto che stavate cercando tra quelli di catalogo, **i nostri specialisti lo troveranno per voi!** Un supporto che consente di risparmiare tempo e di reperire il prodotto migliore al giusto prezzo. Un importante "network" che l'azienda è riuscita a costruire negli anni con i migliori attori nel mondo della sicurezza. Siamo sempre pronti ad aiutarvi nel vostro lavoro e fornirvi informazioni commerciali, soluzioni ed assistenza.

CONSULENZA NORMATIVA



Un servizio di assistenza e consulenza tecnico-normativa altamente competente ed affidabile su tutti i nostri prodotti. Forniamo un'attività di **informazione e supporto**, rispondendo in maniera esauriente e puntuale alle domande di migliaia di clienti. Partecipiamo attivamente all'attività normativa in qualità di membri dell'UNI, del Gruppo di lavoro ISO e dell'associazione per la sicurezza Assosistema - Safety.

SITO E-COMMERCE



www.cartelli.it

Il nostro e-commerce saprà offrirti una navigazione rapida e intuitiva. **Ottimizzato sia per PC che per smartphone**, con contenuti e schede tecniche in costante aggiornamento, offre una grandissima varietà di scelta, acquisti sicuri, **prezzi speciali** e informazioni tecniche dettagliate. Registrati subito, in modo da avere tutti i nostri prodotti a portata di click!

CONFORMITÀ E CERTIFICAZIONI



Produciamo segnaletica secondo i più elevati standard qualitativi, con 16 piani di controllo in accordo con la **norma ISO 9001**. Forniamo segnaletica stradale verticale permanente con marcatura di prodotto **CE**. Vi supportiamo nella realizzazione di progetti relativi alla classificazione di sostanze pericolose (CLP - Classification, Labelling and Packaging) e nella rielaborazione di planimetrie a norma UNI ISO 23601.

SAFE IN®



www.safein.it

Safe In® è il brand di Cartelli Segnalatori dedicato alla sicurezza sul lavoro. Seleziona i migliori prodotti sul mercato, raggiungendo migliaia di aziende manifatturiere e luoghi dove la sicurezza è un fattore determinante per il successo, facendovi risparmiare ogni giorno tempo e denaro. Safe In® è la scelta consapevole per la vostra sicurezza.

20.000 PRODOTTI IN UN CLICK!

The image shows a person's hands holding a smartphone that displays the Cartelli website. The website interface on the phone includes a green header with navigation icons, a search bar, and a main section titled "Ultime novità" (Latest news). Below this, there is a promotional banner for "ATTACCA-STACCA" (Attach-Remove) with the text "Etichette per utilizzo multiple. Applicazione e rimozione facile e veloce" (Labels for multiple use. Easy and fast application and removal) and a "CLICCA QUI" (Click here) button. Further down, a section titled "Il nostro obiettivo è la vostra sicurezza" (Our goal is your safety) states: "Produciamo e vendiamo segnaletica di sicurezza (Cartelli Segnalatori) e articoli per la sicurezza sul lavoro (SafeIn):" (We produce and sell safety signage (Warning Signs) and safety work articles (SafeIn):). At the bottom of the phone screen, there are icons for various safety signs. In the background, a laptop also displays the same website interface, showing a wider view of the product catalog.

Il nostro e-commerce, ottimizzato per PC, tablet e smartphone, saprà offrirti una navigazione rapida e intuitiva. Potrai acquistare i nostri prodotti velocemente e in tutta sicurezza: possiamo offrirti una grandissima varietà di scelta, schede tecniche in costante aggiornamento e informazioni tecniche dettagliate.

INDICE

SEGNALETICA DI SICUREZZA

NEW	Segnaletica di pericolo	26-38
	Segnaletica di pericolo CLP: sostanze pericolose	39
	Segnaletica di pericolo stoccaggio rifiuti e sostanze pericolose	40-41
	Segnaletica di obbligo	42-51
	Segnaletica di divieto	52-67
NEW	Segnaletica multisimbolo	68-70
NEW	Segnaletica di emergenza	74-79,83
NEW	Segnaletica di antincendio	72-73,83
	Segnaletica bifacciale e bifacciale flessibile Fold	80-81
	Segnaletica bifacciale Plexicur	82
	Segnaletica fotoluminescente e fotoluminescente I.M.O.	84-92,148
	Segnaletica Plexi, Crystal, Metal e Colorfix	93-112
	Pittogrammi di segnalazione per superfici in vetro, vetrofanie	113
	Segnaletica adesiva di divieto, obbligo, pericolo	114-115
	Etichette autoadesive non rimovibili	115
	Segnaletica bordo macchina in alluminio e PVC adesivo	116-118
	Minipittogrammi adesivi in rotolo	119
	Segnaletica Easyfix®	120
	Frecce e nastri adesivi per tubazioni	121
	Segnaletica per sostanze pericolose (GHS)	122
	Segnaletica per bombole, etichette autoadesive e cartelli vari	123
	Segnaletica adesiva per tubazioni	124-127
NEW	Segnaletica di informazione	128-133,134-135
	Segnaletica per manutenzione macchinari	133
	Segnaletica di norme e istruzioni	136-140
NEW	Segnaletica messa a terra, per trasporti e depositi G.P.L.	141
	Segnaletica per impianti elettrici e apparecchi laser	142-145
	Cartelli ausiliari e kit per cabine elettriche	146
	Segnaletica in lingua straniera	147-150

SEGNALETICA AZIENDALE E PER PROPRIETÀ PRIVATA

	Segnaletica attacca-stacca	153
	Etichette e cartelli di indicazione per interni	154-156
	Cartelli di indicazione in alluminio specchiato	156
	Cartelli di informazione serie "Qualità"	157
NEW	Segnaletica per aree private, parcheggi e varia	158-163
	Cartello quadrifacciale, Dog parking	163
	Segnaletica di sensibilizzazione sociale	163
	Segnaletica per videosorveglianza	164
	Segnaletica per riserve e divieti, C.E.R.	165
NEW	Segnaletica per aree verdi	166
	Segnaletica per raccolta rifiuti	167
	Segnaletica adesiva "a mezzaluna"	167
	Segnaletica di indicazione per magazzini	168
NEW	Segnaletica "Attenti al cane"	169
	Segnaletica per esercizi commerciali	170

NEW



SEGNALETICA DI PERICOLO

30,31,35

NEW



SEGNALETICA MULTISIMBOLO

68-70

NEW



SEGNALETICA DI EMERGENZA E ANTINCENDIO

73-77

NEW



SEGNALETICA PER PROPRIETÀ PRIVATA

158-163

Etichette controllo qualità	171
Segnaletica per interni in lingua straniera	171

SISTEMI PER LA COMUNICAZIONE VISIVA

Segnaletica "Metalsign" e sistemi di segnaletica autogestibili per interni	173
Sistemi per la comunicazione visiva	174-177
Cornici e cassette portachiaavi	178
Bacheche e lavagne	179,185
Targhe portaplanimetrie	180
Sistemi per la comunicazione visiva	181-183
Leggii, cartelline, supporti e buste	182-183
Wall organizer, portanomi e portabadge	184
Sistemi espositivi per interni ed esterni	185-187
Colonnine tendinastro Safe In®	188-191
Colonnine con cordone	192
Pannelli divisori e kit banner	193
Segnaletica d'ambiente Design & System	194-195
Insegne	196

ARTICOLI PER MAGAZZINI E LOGISTICHE

Segnaletica da pavimento adesiva Safe In®	199-200
Nastri segnaletici	201-202
Nastri anti-effrazione e per imballi	203-204
Accessori e bollini in carta colorati	204
Cavalletti segnapericolo	205
Etichette magnetiche	206
Supporti bifacciali flessibili Fold	207
Numeri e lettere per scaffalature	208-209
Sistemi di marcatura a vernice e traccialinee Safe In®	210-211
Dime in cartone e in alluminio	212-213
Segnali, scritte e bolli autoadesivi da pavimento	214-215
Pannelli retroriflettenti e profili rifrangenti	215
Paracolpi in eva espansa Safe In® e in poliuretano	216-217
Paracolpi grande formato e per colonne	218-219
NEW Barriere in polietilene per aree industriali	220-221
Sistemi di protezione per aree industriali e macchinari	222-225
NEW Scale, ponteggi e sgabelli	226-229
Carrelli, bilance e pannelli porta attrezzi	230
Tavoli da lavoro e cassetiere	231
Regge, tendiregge e polietilene a bolle d'aria	232
Transpallet, saldatrici e sacchetti	233
Buste per magazzini e bauli	234
Contenitori multiuso e cassette basculanti	235-236
Pallet, cargopallet e contenitori in lamiera	237-238
NEW Articoli portautensili	239
Taglierini di sicurezza	240-241
Sigilli di sicurezza	242-243
Marcatori industriali	244-245
NEW Torce e lampade da lavoro	246-247
NEW Luci da cantiere	248
NEW Sistemi di illuminazione per aree estese	249
NEW Ventilatore a turbina e generatori di aria calda	249
Segnalatori luminosi e sonori	250



BARRIERE FLESSIBILI DI DELIMITAZIONE 220-221



TORCE, FARI E LAMPADE DA LAVORO 246-249



PEDANA RISCALDANTE 266



ESOSCHELETRO 269

SISTEMI PER LA PREVENZIONE DEI RISCHI

Nastri e strisce antiscivolo standard Safe In®	252-253
Nastri antiscivolo impermeabili, conformabili e fotoluminescenti Safe In®	254
Prodotti antiscivolo e fotoluminescenti	255-256
Sistemi di protezione per industrie	257
Sistemi di protezione perimetrali per aree industriali	258-259
Sistemi di protezione per macchine utensili	260
Grigliati componibili e pannelli di laminato in vetroresina	261
Pedane e tappeti defaticanti	262-265
Tappeto antipolvere e per protezione ginocchia	265
NEW Pedana riscaldante e tappeti per il traffico pedonale	266
Tappeti sanificanti e personalizzabili	267
NEW Protezioni ergonomiche, supporti lombari ed esoscheletro	268-269
Etichette e targhette di identificazione, aste graduate	270-272
Bollini datario e piastrelle numerate	273
Sistemi di protezione per vetri	274

SEGNALETICA STRADALE E CANTIERISTICA

Segnaletica di pericolo, divieto e obbligo	278-280
Croci di Sant'Andrea	279
Pannelli integrativi ai segnali triangolari e circolari	281
Segnaletica utile per la guida e vari	282
Segnaletica di indicazione, direzione e per agriturismi	283
Segnaletica turistica e di informazione	284-285
Targhe viarie, di località e delineatori di curva	285
NEW Segnaletica mobile e per cantieri temporanei	286-287
NEW Segnaletica per cantieri in polionda	288-289
Kit cavalletti e cavalletti porta segnale	290-291
Staffe, nastri, fascette, collari e kit di fissaggio	292-293
Pali, sostegni, picchetti e reti da cantiere	293
Delimitatori, delineatori e sacchi zavorra	294
Basi, dissuasori di sosta e articoli per movieri	295
Trasenne componibili, catene, paletti, colonnine e basi	296-299
NEW Sistemi di delimitazione aree e piastrelle tattili	300-301
Barriere, trasenne Safe In®, quadrilateri e pannelli di segnalazione	302-306
Dispositivi antisosta e archetti parapetonali	307-308
Barriere New Jersey, delineatori, cordoli e delimitatori di corsia	309
Coni segnaletici, delineatori e accessori	310-311
NEW Rallentatori di velocità e profili di delimitazione	312-313
NEW Rampe passacavi	314-315
Paracolpi, angolari, profili e barre di delimitazione	316
NEW Delimitazione aree parcheggi e battiruota	317
Paracolpi per banchine, rampe e passerella pedonale	318
Articoli per aree ciclabili, cordoli, dissuasori e rotonde in gomma	319
Specchi stradali e di sorveglianza	320-321
Maniche a vento, barrette luminose, bandiere e articoli scioglineve	322-323
Proiettori led, impianti sequenziali, catadiottri e marker stradali	324-325
Lampade da cantiere, torce a vento e a led, misuratore stradale	326
Kit segnaletico per pronto intervento, kit ADR e triangolo auto ferma	327
Segnalazione e trasporto di merci pericolose	328-333
NEW Calzatoie e articoli per camion	334

NEW



SISTEMI DI DELIMITAZIONE AREE

300-301

NEW



ELMETTI DA LAVORO

365-366

NEW



OCCHIALI DI PROTEZIONE

374

NEW



ABBIGLIAMENTO AD ALTA VISIBILITÀ

385

DISPOSITIVI DI PROTEZIONE INDIVIDUALE

NEW	Protezione delle vie respiratorie, spazi confinati, rilevatori di gas	340-357
	Protezione dell'udito	360-363,369-370
NEW	Protezione del capo e del viso	365-370
NEW	Torçe da testa e per elmetti	371
NEW	Protezione degli occhi	374-379
	Abbigliamento boscaiolo	379
	Abbigliamento e accessori per la saldatura	380-381
	Abbigliamento alluminizzato	382
	Abbigliamento multirischio trivalente e per arco elettrico	383
NEW	Abbigliamento multirischio e alta visibilità	384-388
	Accessori ad alta visibilità, camici e indumenti anti pioggia	389
NEW	Abbigliamento da lavoro	390-393
	Abbigliamento intimo tecnico	394
NEW	Articoli rinfrescanti e riscaldanti	395
	Abbigliamento e accessori monouso, protezione chimica	397-399
NEW	Protezione delle mani	402-411
	Indumenti e accessori in maglia metallica	406
	Creme barriera per la protezione delle mani	412-413
NEW	Protezione dei piedi	415-419
NEW	Protezione da cadute	421-426
NEW	Protezione dall'elettricità	427-429
	Protezione per la saldatura	430-431
	Custodie e articoli per disinfezione D.P.I.	432

ARTICOLI PER EMERGENZA E PRIMO SOCCORSO

	Armadietti e valigette di medicazione linea "fluo" Safe In®	435-436
	Armadietti e valigette di medicazione allegato 1 "Maggiorato"	436
NEW	Armadietti e valigette di medicazione allegato 1 e 2	437-438
NEW	Armadietti e valigette di medicazione allegato 3 e vuote	439
NEW	Valigette, borse di medicazione e kit speciali	440-441
NEW	Ausili per la medicazione e dispenser cerotti	442-443
NEW	Sfigmomanometri e rianimatori	444
NEW	Forbici e articoli vari per il primo soccorso	445
NEW	Barelle, fermacapo e defibrillatore	446-447
NEW	Prodotti antiustione e kit pronto intervento	448
	Attrezzature per infermerie aziendali	449
	Docce e lavaocchi di emergenza	451-458

SISTEMI E ATTREZZATURE ANTINCENDIO

	Estintori portatili e carrellati	460-461
	Cappucci di protezione per estintori	461
	Piantane portaestintori e carrelli schiumogeni	462
	Cassette portaestintori e idranti a muro	463
	Cassette e kit a corredo idranti	464
	Cassette portadocumenti e portachiavi di sicurezza	465
	Ricambi per idranti	465
	Naspi CE e ricambi	466
	Lastre di ricambio e secchio per sabbia	466
NEW	Stivali antincendio e megafoni	467
	Attrezzature antincendio e kit borsa	468

NEW



GUANTI PER RISCHIO MECCANICO

403

NEW



ARTICOLI PROTEZIONE DALL'ELETTRICITÀ

427-429

NEW



VALIGETTE E AUSILI PER LA MEDICAZIONE

437-443

NEW



RIANIMATORI E DEFIBRILLATORE

444,447

Componenti per sistemi antincendio	468
Trombe a gas e rilevatori di fumo	469
Dispositivi di bloccaggio Lockout/Tagout	470-472
NEW Stampanti portatili per etichette	472
Articoli per l'evacuazione marittima	473
NEW Lampade e torce ATEX antideflagranti	474-476
Armadi per attrezzature antincendio	477-479
NEW Indumenti alluminizzati e coperte antifiama	480

GESTIONE SOSTANZE PERICOLOSE E INFIAMMABILI

NEW Vasche di contenimento per fusti	482-486
Vasche mobili, impilabili e vassoi di contenimento	485
Contenitore per fusti Over-drum	486
Vasche di contenimento per cisternette	487
Scaffalature per cisternette	488
Depositi di stoccaggio	489,491-493
Supporti per fusti e pavimentazione in acciaio	490
Depositi e articoli per la movimentazione di bombole a gas	491
Articoli per stoccaggio rifiuti amianto	494-495
NEW Contenitori per rottami e navetta per manutenzione aerea	496-497
Contenitori per rifiuti speciali	498
Armadi per stoccaggio	498-501
Armadi per liquidi infiammabili	500
Stoccaggio liquidi infiammabili	501-504
Vasche di contenimento pieghevoli	504
Accessori e posaceneri autoestinguenti	505
Prodotti assorbenti per acido solforico	506
NEW Barriere contro gli allagamenti	507
Prodotti assorbenti per sversamenti accidentali Safe In®	508-514
Prodotti assorbenti per sversamenti accidentali	515-516

ARTICOLI PER LA COLLETTIVITÀ, RACCOLTA DEI RIFIUTI E IGIENE

Armadi spogliatoio	518-519
Panchine per spogliatoi	519
Portabiciclette e panchine	520-521
Carta asciugamani e prodotti per l'igiene	522-523
Posaceneri e gettacarta autoestinguenti	524
Gettacarta modulari e per la raccolta differenziata	525
NEW Posaceneri e gettacarta per interni ed esterni	526-527
NEW Stazioni per la raccolta differenziata	528-529
NEW Gettacarta murale e modulari da pavimento	529-530
NEW Pattumiere a pedale, con carrello reggisacco e HACCP	531-532
Cestini Milano e kit per deiezioni canine	533
Bidoni, carrello e trespolo portarifiuti	534
Sacchi portarifiuti	534
Cassonetti portarifiuti a 2 ruote	535-536
Cassonetti portarifiuti a 4 ruote	536



LAMPAD E TORCE ATEX ANTIDEFLAGRANTI 474-476



VASCHE DI CONTENIMENTO E BENNE 484,496



ARRIERE CONTRO GLI ALLAGAMENTI 507



GETTACARTA E STAZIONI RACCOLTA RIFIUTI 528-530

DIAMO FORMA ALLE TUE IDEE

Poster, volantini, brochure informative, biglietti da visita, flyer, cataloghi, etc... Qualunque sia la tua esigenza, assieme a noi troverai sicuramente il prodotto che la valorizzerà al meglio. Lavoriamo insieme ai nostri clienti per dare forma alle loro idee di comunicazione e, grazie al nostro reparto grafico interno, non c'è progetto che non possa essere pensato, progettato e infine stampato.



RICHIEDI UN PREVENTIVO GRATUITO!

Regole d'Oro sulla Sicurezza

Tu hai l'autorità di fermare un'attività

- Lavori in quota
- Sistemi energizzati
- Prevenzione incendi
- Gas tossici
- Gestione delle modifiche
- Guida sicura
- Permessi di lavoro
- Sicurezza degli scavi

SAFETY CARD

(Documento informativo per il Visitatore)⁽¹⁾
D. Lgs. 105/2015 Allegato B Appendice 1 comma 1.5

Legenda di rischio

- Uscite di sicurezza
- Pericolo INDETERMINATO e gravi
- Area dove è vietato l'accesso del pubblico
- Area dove con alcune precauzioni è consentito l'accesso "visuale"

Sotto l' visitatore accede al sito e per il personale che visita il sito, il visitatore è responsabile di sé e dei propri familiari. Il visitatore è tenuto a rispettare le norme di sicurezza e a non recitare in alcun modo.

Norme generali di comportamento

L'ingresso dei visitatori è possibile solo se regolarmente autorizzati dal personale di pertinenza. Ogni visitatore viene dotato di un apposito badge da tenere sempre ben in vista. Nessun visitatore può spostarsi in libertà se non accompagnato dal personale an.

Attenzione della Raffineria è vietato:

- ☑ fumare in non nelle zone appositamente predisposte;
- ☑ utilizzare il cellulare;
- ☑ utilizzare macchine fotografiche;
- ☑ utilizzare videocamere;
- ☑ accedere alle aree di impianto se non regolarmente autorizzati;
- ☑ accedere con veicoli non espressamente autorizzati.

P.E.I. Piano di Emergenza Interno

Revisione 14

Revisione	Redazione	Verifica	Approvazione
14	Responsabile Sicurezza	RSB Project	RSB



LAVORIAMO INSIEME PER LA SICUREZZA



safe in®

LA SCELTA CONSAPEVOLE PER LA **SICUREZZA** DEI LAVORATORI

Safe In® è il brand di prodotti dedicati alla sicurezza sul lavoro. Nato da una esperienza sessantennale sul mercato di riferimento, si avvale di un'offerta di 20.000 prodotti, tutti dedicati alla sicurezza dei lavoratori. Attraverso una rete distributiva professionale con catalogo dedicato che conta centinaia di distributori, i loro agenti e negozi sul tutto il territorio, Safe In® è in grado di raggiungere decine di migliaia aziende manifatturiere e luoghi dove la sicurezza è un fattore determinante per il successo, offrendo una gamma unica di prodotti accompagnata dai marchi più importanti del settore.





BARRIERE ANTIURTO FLESSIBILI

d-flexx

VEDI PAG. 220

PROTEGGONO DAGLI IMPATTI ACCIDENTALI,
RITORNANDO ALLA LORO FORMA ORIGINALE
DOPO UNA COLLISIONE!



Le barriere d-flexx, distribuite in esclusiva per l'Italia da Safe In®, sono realizzate in polietilene flessibile. Riducono notevolmente i costi di riparazione e manutenzione in quanto, dopo una collisione, ritornano alla loro forma originale. Ideali in magazzino, nei reparti produttivi e logistici, adatte per uso esterno e interno. Contattaci per un preventivo!

NIGHTSTICK®

Life Depends on Light™

VEDI PAG. 474

TORCE PER AREE A RISCHIO ESPLOSIONE

Le torce Nightstick per zone a rischio esplosione (Atex) sono realizzate con materiali di prima qualità, riflettori precisi ed elettronica all'avanguardia. I valori di lumen sono superiori alla maggior parte dei prodotti della concorrenza: tutto questo senza trascurare il design, semplice e funzionale.



uvex

GUANTI IN BAMBOO TWINFLEX®

Guanti in Bamboo TwinFlex®, tecnologia brevettata che garantisce il massimo comfort alla pelle, morbida vestibilità, e rapido assorbimento dell'umidità. Ottima presa in condizioni asciutte e leggermente umide/oleose. Eccellente resistenza all'abrasione, rinforzo nell'area del pollice. Resistenza al taglio (livello D).

VEDI PAG. 402



PGP

VEDI PAG. 412



PROTEGGI, CURA E RISPETTA LE TUE MANI

Le creme barriera prevengono la penetrazione e l'assorbimento nella pelle di diversi liquidi e sostanze pericolose. Riducono il rischio di lesioni e altre reazioni derivate dall'esposizione o contatto con agenti tossici. L'uso di questi prodotti è raccomandato dalla Direttiva UE 2019/1832.



Stampanti per etichette robuste e affidabili, pensate per resistere alle condizioni di cantiere più difficili

Semplici e intuitive, le stampanti Brady sono pensate per essere utilizzate ovunque, grazie alla grande autonomia di ricarica e alla straordinaria resistenza a cadute, urti e schiacciamenti.



DEFIBRILLATORE SEMIAUTOMATICO

Il defibrillatore semiautomatico HeartSine, compatto e facile da usare, offre ai primi soccorritori una tecnologia salvavita eccellente. Leggero (1,1 kg batteria inclusa) e di facile utilizzo (con soli due pulsanti: "On/Off" e "Scarica").



PRIMERO AIR

CARATTERISTICHE

- **AERAZIONE** 14 prese d'aria sagomate per impedire l'ingresso di detriti.
- **SISTEMA ERGO FIT** Si sposta verso l'alto e verso il basso e offre supporto alla nuca per una vestibilità sicura.
- **IMBOTTITURA 2DRY** Tessuto con tecnologia traspirante per un comfort prolungato.
- **SISTEMA CLICK-IN** Sistema di attacco che consente di agganciare e sganciare facilmente l'imbottitura.
- **CINTURINO AVANZATO** 5 punti di regolazione e chiusura colorata conforme agli standard EN.
- **ANELLO REGGICASCO** Per cinturino sottogola: consente di fissare saldamente il casco a un'imbracatura.
- **SISTEMA EASY CLICK** Slot integrati per la protezione degli occhi e del viso. Sono necessari adattatori.
- **PREDISPOSIZIONE CUFFIE ANTIRUMORE** Slot da 30 mm (EURO) per il fissaggio di cuffie antirumore.
- **CLIP FERMALAMPADA RIMOVIBILI** 4 clip di fissaggio della lampada in nylon rimovibili.



DISPOSITIVO DI FUGA PARAT 1200

Progettato secondo criteri di semplicità, Dräger PARAT® 1200 è un dispositivo di fuga estremamente compatto con boccaglio/stringinaso, dotato di un filtro multigas ABEK che offre 10 minuti di protezione contro una varietà di gas e vapori industriali tossici. Questo dispositivo salvavita è approvato ai sensi dell'unica normativa riconosciuta in materia di dispositivi di fuga per ambienti industriali (DIN 58647-7).





ASSOSISTEMA

SAFETY Produzione, Distribuzione
e Manutenzione di DPI

ASSOSISTEMA SAFETY

rappresenta le imprese che producono, distribuiscono e mantengono in stato di efficienza i dispositivi di protezione individuale e collettiva, per la tutela e la salute di tutti i lavoratori di tutti i settori merceologici. Le imprese associate sono leader sul mercato nazionale ed internazionale.

Producono beni e servizi secondo le normative europee e nazionali, garantendo la massima sicurezza e qualità dei prodotti utilizzati.



DIREZIONE SICUREZZA

Una filiera di eccellenza che va dalla produzione all'immissione sul mercato dei dispositivi di protezione individuale, al servizio con tutte le attività connesse alla gestione; all'utilizzo e alla manutenzione dei prodotti. Assosistema Safety ha l'obiettivo di consolidare la sua presenza europea e di comunicare all'Unione Europea la propria posizione in merito alle varie proposte legislative, procedure e standard del settore dei DPI e della sicurezza del lavoro.

www.assosistema.it

I soci Assosistema SAFETY



Soci aggregati





Cartelli Segnalatori



COME QUALITÀ DEL SISTEMA AZIENDALE

Cartelli Segnalatori è da sempre impegnata a soddisfare le esigenze e le aspettative di tutti i suoi clienti, se ne fa carico e li trasforma nei requisiti che caratterizzano l'azienda stessa ed i marchi che la identificano sul mercato. Il tutto in accordo con la norma ISO 9001 - certificato RINA n. 40211.



COME QUALITÀ DEL SERVIZIO

Cartelli Segnalatori è da sempre focalizzata al miglioramento continuo nel servizio, oltre che nel prodotto. Alimenta la sua offerta attraverso una costante ricerca di prodotti affidabili proposti e distribuiti su un catalogo che vanta più di 20.000 articoli ed un sito con circa 8.000 visualizzazioni al giorno.



COME QUALITÀ DEL PRODOTTO

Cartelli Segnalatori produce da anni secondo standard qualitativi fra i più alti riconosciuti dal mercato, con processi che comprendono 16 piani di controllo, 2 prove distruttive settimanali e prove di invecchiamento accelerato di terza parte. A queste si aggiunge la certificazione di prodotto per la segnaletica stradale verticale permanente - certificato CE di conformità n° 0474-CPR-0730 RINA Service.



COME QUALITÀ DELL'ATTIVITÀ

Dal 1986 Cartelli Segnalatori è presente attivamente in associazioni di categoria quali Anima Assosegnaletica e Assosistema Safety, impegnate, fra le altre cose, nella formazione ed informazione delle parti interessate; è membro dell'associazione Prevenzione Incendi Italia, del gruppo di lavoro segnaletica di sicurezza e stradale UNI e dal 1995 partecipa ai lavori del gruppo di lavoro internazionale ISO TC145/SC2/WG1.



REALIZZIAMO IL TUO CARTELLO PERSONALIZZATO

Se tra la gamma di codici presenti a catalogo non trovi il cartello o l'etichetta che desideri, richiedi un cartello o un'etichetta personalizzata! Da un segnale tecnico a un cartello più "artistico" o spiritoso, con l'inserimento di scritte e loghi particolari, non c'è limite a ciò che possiamo produrre! Per realizzare un cartello personalizzato, è necessario fornire le seguenti informazioni:



DIMENSIONI E QUANTITÀ

Scegliete tra i formati standard riportati in basso o indicate la misura speciale da voi richiesta.

SEGNALI DI DIVIETO, OBBLIGO E PERICOLO



333 x 500 mm
500 x 700 mm



115 x 160 mm
145 x 164 mm
166 x 233 mm
220 x 250 mm
270 x 370 mm
360 x 400 mm
435 x 603 mm
580 x 650 mm



115 x 140 mm
166 x 210 mm
270 x 330 mm
435 x 530 mm



115 x 178 mm
145 x 182 mm
166 x 262 mm
220 x 280 mm
270 x 430 mm
360 x 450 mm
435 x 678 mm
580 x 730 mm



145 x 145 mm
220 x 220 mm
360 x 360 mm
580 x 580 mm



350 x 125 mm
765 x 270 mm
833 x 333 mm
1400 x 435 mm
1845 x 615 mm

SEGNALI ANTINCENDIO E DI SALVATAGGIO

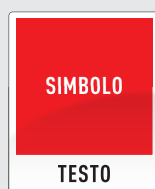

120 x 145 mm
160 x 210 mm
250 x 310 mm
400 x 500 mm
530 x 652 mm

SEGNALI DI INFORMAZIONE



350 x 125 mm
300 x 200 mm
200 x 150 mm

SEGNALI MULTISIMBOLO E SOSTANZE PERICOLOSE



500 x 333 mm
300 x 200 mm

TESTI E LOGHI

È possibile scegliere tra migliaia di simboli a catalogo, oppure inviare un proprio simbolo/logo. Possibilità di realizzare cartelli anche in lingua straniera. Per la stampa del vostro simbolo/logo, inviare un **file in vettoriale** creato da un programma di disegno grafico (Illustrator, Freehand, CorelDraw o simili) in uno dei seguenti formati:

- **Curve, tracciati o percorsi per MacOs o Windows** (un'immagine descritta mediante punti, linee, curve e poligoni).
- **Eps vettoriale ad alta risoluzione (300 dpi)** già in misura e nel formato pronto per essere stampato (scala 1:1).
- **Pdf generato dal Logo vettoriale** in originale (no scansioni da fogli, etichette, immagini, ecc.).

TIPOLOGIA DI STAMPA

In base al quantitativo e all'utilizzo necessario, è possibile scegliere tra:

- **Stampa serigrafica:** ideale per tirature di quantitativi elevati.
- **Stampa digitale:** permette la stampa diretta da un file in tracciati.
- **Scritta adesiva:** veloce ed economica per realizzare anche un pezzo singolo.

MATERIALI E FINITURE

Offriamo una vastissima gamma di materiali tra i quali scegliere:

alluminio piano, alluminio sciolato, lamiera sciolata, PVC rigido, PVC adesivo, PVC espanso, plexiglass, policarbonato, PETG, vinile antimannomissione, magnetico, attacca-stacca.

Inoltre sono disponibili tre diverse finiture superficiali:

normale, luminescente, rifrangente.



SEGNALETICA SPECIALE

A LISTINO

In tabella trovate i formati maggiormente richiesti, selezionati per voi.
Realizzazione in stampa digitale o lettere applicate per quantità inferiore a 10 pezzi.

DIMENSIONI	TIPOLOGIA E MATERIALE	FINITURA	CODICE
160 x 160 mm	cartello in alluminio piano spessore 0,5 mm	-	SXD15W
160 x 210 mm	cartello in alluminio piano spessore 0,5 mm	-	SXD20W
250 x 250 mm	cartello in alluminio piano spessore 0,5 mm	-	SXD15X
250 x 310 mm	cartello in alluminio piano spessore 0,5 mm	-	SXD20X
250 x 310 mm	cartello bifacciale in alluminio piano spessore 0,5 mm	-	SXD20BIX
300 x 200 mm	cartello in alluminio piano spessore 0,5 mm	-	SXD31
333 x 500 mm	cartello in alluminio piano spessore 0,7 mm	-	SXD18X
350 x 125 mm	cartello in alluminio piano spessore 0,5 mm	-	SXD18K
400 x 400 mm	cartello in alluminio piano spessore 0,7 mm	-	SXD15Y
400 x 500 mm	cartello in alluminio piano spessore 0,7 mm	-	SXD20Y
400 x 600 mm	cartello in alluminio piano spessore 0,7 mm	-	SXD56
500 x 700 mm	cartello in alluminio piano spessore 1 mm	-	SXD18Y
160 x 160 mm	etichetta in PVC adesivo	-	SXD15WS
160 x 210 mm	etichetta in PVC adesivo	-	SXD20WS
250 x 250 mm	etichetta in PVC adesivo	-	SXD15XS
250 x 310 mm	etichetta in PVC adesivo	-	SXD20XS
300 x 200 mm	etichetta in PVC adesivo	-	SXD31S
333 x 500 mm	etichetta in PVC adesivo	-	SXD18XS
350 x 125 mm	etichetta in PVC adesivo	-	SXD18KS
400 x 400 mm	etichetta in PVC adesivo	-	SXD15YS
400 x 500 mm	etichetta in PVC adesivo	-	SXD20YS
500 x 700 mm	etichetta in PVC adesivo	-	SXD18YS
400 x 600 mm	cartello in lamiera sciolata spessore 1 mm	-	SXDFL56Y
400 x 600 mm	cartello in lamiera sciolata spessore 1 mm	pellicola rifrangente	SXDFLR56Y
500 x 250 mm	cartello in lamiera sciolata spessore 1 mm	pellicola rifrangente	SXTFLR922
530 x 180 mm	cartello in lamiera sciolata spessore 1 mm	pellicola rifrangente	SXTFLR911
600 x 900 mm	cartello in lamiera sciolata spessore 1 mm	-	SXDFL56Z
600 x 900 mm	cartello in lamiera sciolata spessore 1 mm	pellicola rifrangente	SXDFLR56Z
800 x 270 mm	cartello in lamiera sciolata spessore 1 mm	pellicola rifrangente	SXTFLR912
1000 x 200 mm	cartello in lamiera sciolata spessore 1 mm	pellicola rifrangente	SXTFLR6...*
1000 x 250 mm	cartello in lamiera sciolata spessore 1 mm	-	SXTFL6810
1000 x 250 mm	cartello in lamiera sciolata spessore 1 mm	pellicola rifrangente	SXTFLR6810
1250 x 250 mm	cartello in lamiera sciolata spessore 1 mm	pellicola rifrangente	SXTFLR7...*
1300 x 300 mm	cartello in lamiera sciolata spessore 1 mm	pellicola rifrangente	SXTFLR53...*
400 x 600 mm	cartello in alluminio sciolato spessore 2,5 mm	-	SXDFA56Y
400 x 600 mm	cartello in alluminio sciolato spessore 2,5 mm	pellicola rifrangente	SXDFA56Y
500 x 250 mm	cartello in alluminio sciolato spessore 2,5 mm	pellicola rifrangente	SXTFAR922
530 x 180 mm	cartello in alluminio sciolato spessore 2,5 mm	pellicola rifrangente	SXTFAR911
600 x 900 mm	cartello in alluminio sciolato spessore 2,5 mm	-	SXDFA56Z
600 x 900 mm	cartello in alluminio sciolato spessore 2,5 mm	pellicola rifrangente	SXDFA56Z
800 x 270 mm	cartello in alluminio sciolato spessore 2,5 mm	pellicola rifrangente	SXTFAR912
1000 x 200 mm	cartello in alluminio sciolato spessore 2,5 mm	pellicola rifrangente	SXTFAR6...*
1000 x 250 mm	cartello in alluminio sciolato spessore 2,5 mm	-	SXTFA6810
1000 x 250 mm	cartello in alluminio sciolato spessore 2,5 mm	pellicola rifrangente	SXTFAR6810
1250 x 250 mm	cartello in alluminio sciolato spessore 2,5 mm	pellicola rifrangente	SXTFAR7...*
1300 x 300 mm	cartello in alluminio sciolato spessore 2,5 mm	pellicola rifrangente	SXTFAR53...*

* Per completare il codice vedi pagina 270.

DISTANZE DI LETTURA

$$A \geq \frac{L^2}{2000}$$

A = m² | L = m

D. LGS 81/08 - ALLEGATO XXV

Le dimensioni dei segnali di sicurezza devono essere tali che l'area A del pittogramma e la distanza massima L, dalla quale il segnale deve essere ancora percepibile, soddisfino la seguente relazione:

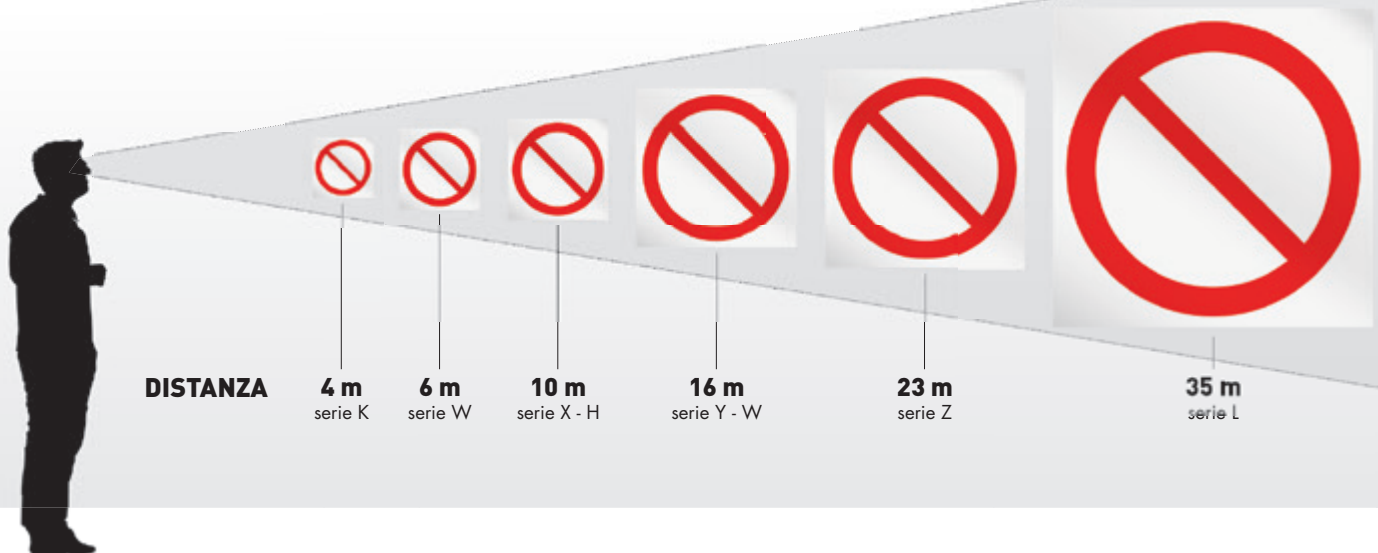

SERIE K (4 metri)	SERIE W (6 metri)	SERIE X - H (10 metri)	SERIE Y - W (16 metri)	SERIE Z (23 metri)	SERIE L (35 metri)
11...K (lato 140 mm)	11...W (lato 210 mm)	11...X (lato 350 mm)	11...Y (lato 560 mm)	11...Z (lato 812 mm)	
13...K (115 x 115 mm)	13...W (166 x 166 mm)	13...X (270 x 270 mm)	13...Y (435 x 435 mm)	13...Z (615 x 615 mm)	13...L (910 x 910 mm)
15...K (120 x 120 mm)	15...W (160 x 160 mm)	15...X (250 x 250 mm)	15...Y (400 x 400 mm)	15...Z (530 x 530 mm)	15...L (800 x 800 mm)
16...K (140 x 70 mm)	16...W (220 x 100 mm)	16...X (370 x 170 mm)	16...Y (580 x 260 mm)	18...Z (1845 x 615 mm)	
17...K (350 x 125 mm)		17...X (333 x 500 mm)	17...Y (500 x 700 mm)		
		17...H (833 x 333 mm)	18/19...Y (500 x 700 mm)		
18...K (350 x 125 mm)		18/19...X (333 x 500 mm)	18...W (1400 x 435 mm)		
19...K (350 x 125 mm)		18/19...H (765 x 270 mm)			
20...K (120 x 145 mm)	20...W (160 x 210 mm)	20...X (250 x 310 mm)	20...Y (400 x 500 mm)	20...Z (530 x 652 mm)	
40...K (145 x 145 mm)	40...W (220 x 220 mm)	40...X (360 x 360 mm)	40...Y (580 x 580 mm)		
41...K (145 x 164 mm)	41...W (220 x 250 mm)	41...X (360 x 400 mm)	41...Y (580 x 650 mm)		
44...K (145 x 182 mm)	44...W (220 x 280 mm)	44...X (360 x 450 mm)	44...Y (580 x 730 mm)		
61...K (115 x 140 mm)	61...W (166 x 210 mm)	61...X (270 x 330 mm)	61...Y (435 x 530 mm)		
62...K (115 x 160 mm)	62...W (166 x 233 mm)	62...X (270 x 370 mm)	62...Y (435 x 603 mm)		
63...K (115 x 178 mm)	63...W (166 x 262 mm)	63...X (270 x 430 mm)	63...Y (435 x 678 mm)		
715...K (220 x 120 mm)	715...W (300 x 160 mm)	715...X (480 x 250 mm)			
720...K (320 x 120 mm)	720...W (440 x 160 mm)	720...X (710 x 250 mm)			

SERIE E DIMENSIONI

COME LEGGERE UN CODICE

NORMA UNI EN ISO 7010

La lettera E prima del codice identifica un cartello a norma UNI EN ISO 7010

E L 15107 K P

ULTERIORI CARATTERISTICHE

Di seguito alcuni esempi:
P = PVC rigido dielettrico
R = rifrangente su alluminio
S = pellicola autoadesiva
BI = bifacciale

CARATTERISTICHE

Di seguito alcuni esempi:
L = fotoluminescente
SEP = linea Plexi
SEC = linea Crystal
SEM = linea Metal
SIC = linea Colorfix

CODICE

Riportato sotto ogni cartello

FORMATO

Le dimensioni variano in base alla tipologia e sono riportate nelle tabelle di ogni pagina: **K - X - H - Y - W - Z**



SEGNALETICA DI SICUREZZA

SEGNALETICA DI PERICOLO	26-38
SEGNALETICA DI PERICOLO CLP: SOSTANZE PERICOLOSE	39
SEGNALETICA DI PERICOLO STOCCAGGIO RIFIUTI E SOSTANZE PERICOLOSE	40-41
SEGNALETICA DI OBBLIGO	42-51
SEGNALETICA DI DIVIETO	52-67
SEGNALETICA MULTISIMBOLO	68-70
SEGNALETICA DI EMERGENZA	74-79,83
SEGNALETICA DI ANTINCENDIO	72-73, 83
SEGNALETICA BIFACCIALE E BIFACCIALE FLESSIBILE FOLD	80-81
SEGNALETICA BIFACCIALE PLEXICUR	82
SEGNALETICA FOTOLUMINESCENTE E FOTOLUMINESCENTE I.M.O	84-92,148
SEGNALETICA PLEXI, CRYSTAL, METAL E COLORFIX	93-112
PITTOGRAMMI DI SEGNALE PER SUPERFICI IN VETRO, VETROFANIE	113
SEGNALETICA ADESIVA DI DIVIETO, OBBLIGO, PERICOLO	114-115
ETICHETTE AUTOADESIVE NON RIMOVIBILI	115
SEGNALETICA BORDO MACCHINA IN ALLUMINIO E PVC ADESIVO	116-118
MINIPITTOGRAMMI ADESIVI IN ROTOLO	119
SEGNALETICA EASYFIX®	120
FRECCE E NASTRI ADESIVI PER TUBAZIONI	121
SEGNALETICA PER SOSTANZE PERICOLOSE (GHS)	122
SEGNALETICA PER BOMBOLE, ETICHETTE AUTOADESIVE E CARTELLI VARI	123
SEGNALETICA ADESIVA PER TUBAZIONI	124-127
SEGNALETICA DI INFORMAZIONE	128-133,134-135
SEGNALETICA PER MANUTENZIONE MACCHINARI	133
SEGNALETICA DI NORME E ISTRUZIONI	136-140
SEGNALETICA MESSA A TERRA, PER TRASPORTI E DEPOSITI G.P.L.	141
SEGNALETICA PER IMPIANTI ELETTRICI E APPARECCHI LASER	142-145
CARTELLI AUSILIARI E KIT PER CABINE ELETTRICHE	146
SEGNALETICA IN LINGUA STRANIERA	147-150

GUIDA ALLA SCELTA DEI MATERIALI

I segnali di nostra produzione sono costruiti nei materiali indicati all'inizio di ogni gruppo di cartelli. Le dimensioni e le caratteristiche cromatiche e colorimetriche dei segnali sono conformi a quanto prescritto dalle norme UNI 7543, ISO 7010 cui fa riferimento il D. Lgs. 81 del 09/04/08 Titolo V. Tolleranza massima dei materiali -0 +3 mm (norma UNI EN 485-4). Tolleranza distanza di lettura della simbologia: ± 2%.

I NOSTRI SEGNALI HANNO UN'ELEVATA RESISTENZA E DURATA NEL TEMPO, GRAZIE ALLE CARATTERISTICHE DELLA STAMPA E DEI MATERIALI.



I COLORI UTILIZZATI NEI CARTELLI SONO SIMILI AI SEGUENTI RAL:

- GIALLO (RAL 1023)
- ROSSO (RAL 3020)
- BLU (RAL 5017)
- VERDE (RAL 6024)
- BIANCO (RAL 9010)
- NERO (RAL 9011)



ALLUMINIO PIANO

Adatto in ambienti esterni ed interni con atmosfera anche molto aggressiva, e debolmente corrosiva. Buona resistenza ai solventi.

Spessori da 0,5 a 1 mm (indicati all'inizio di ogni gruppo di cartelli). Tolleranze dimensionali secondo Norma UNI EN 485-4. Lamiera di alluminio lega EN AW-3105 o, in alternativa, EN AW-5005 (composizione chimica in accordo alla Norma UNI EN573-3), stato fisico da H42 a H48 (caratteristiche meccaniche in accordo alla Norma UNI EN1396) in funzione degli spessori, verniciata sul primo lato con film poliuretano, ottenuta con il seguente ciclo:

1 Sgrassaggio - 2 Risciacquo/lavaggio - 3 Pretrattamento esente da cromo - 4 Passivazione - 5 Mano di vernice poliuretano a finire nel colore di fondo e mano di trasparente poliuretano protettivo sul retro e relativa cottura - 6 Stampa dei segnali, dei simboli e delle scritte - 7 Definitiva cottura a forno

Prove di invecchiamento

Come previsto dalla norma UNI7543-1 punto 13, campioni rappresentativi dei segnali sono stati sottoposti ad una prova di invecchiamento artificiale che verifichi la durata della superficie del segnale nel tempo.

FOTOLUMINESCENTE CARTLUX® DIN PLUS

Adatto in ambienti interni con atmosfera normale.
Per le caratteristiche complete vedere pagina 84.

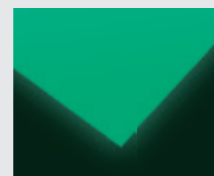

RIFRANGENTE (CLASSE 1)

Adatto in ambienti esterni ed interni con atmosfera anche aggressiva.

Per ambienti con cattiva illuminazione; pellicola retroflettente di classe RA1 (ex classe 1° normale risposta luminosa), a superficie liscia, autoadesiva su supporto di alluminio con caratteristiche cromatiche conformi alla Norma UNI7543.

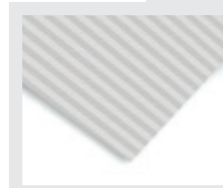

PVC AUTOADESIVO

Adatto in ambienti esterni ed interni con atmosfera normale.

Film di vinile plastificato adesivizzato, con buona resistenza all'invecchiamento, agli agenti atmosferici, agli agenti chimici, (acidi, basi, alcool). Stampa con inchiostri resistenti ai raggi ultravioletti.



PVC RIGIDO

Adatto in ambienti esterni ed interni con atmosfera aggressiva e corrosiva ma con limitate escursioni termiche.

Spessori da 0,5, 1 o 1,5 mm. Lastra in PVC estruso, colore stabilizzato e trattato contro gli agenti atmosferici, stampa con inchiostri resistenti ai raggi ultravioletti. Ottime caratteristiche dielettriche, autoestinguente.



ATTACCA-STACCA (PAG. 153)

Adatto per qualsiasi superficie liscia (vetro, legno, plastica, metallo)

Etichetta in PET con pellicola autoadesiva senza colla, dotata di microventose che consentono al segnale di essere attaccato e staccato più volte senza residui sulle superfici (simil Post-it con adesività su tutta la superficie) e senza effetti negativi sull'adesività.



PERCHÈ SCEGLIERE I NOSTRI CARTELLI?

ELEVATA RESISTENZA E DURATA NEL TEMPO

I nostri cartelli standard sono ottenuti con stampa su supporti in alluminio con inchiostri di alta qualità. I pigmenti in essi contenuti, infatti, possiedono un'elevata resistenza alla luce rendendoli adatti anche all'applicazione all'esterno e, conseguentemente, molto resistenti nel tempo. Inoltre la base degli inchiostri e l'alluminio di prima qualità con finitura poliuretanicca rendono il cartello particolarmente resistente al graffio ed agli agenti chimici in generale. Chiedi al tuo fornitore di cartelli un'attestazione che garantisca la conformità a queste caratteristiche per poterne valutare la reale qualità.

VARIETÀ DI GAMMA E DISPONIBILITÀ DI MAGAZZINO

Disponiamo della gamma più ampia sul mercato. Cartelli ed etichette standard con svariate simbologie, testi, dimensioni e materiali per soddisfare le esigenze di ogni settore. 10.000 referenze con un'ottima disponibilità di stock, prossima al 99% delle richieste che giornalmente ci pervengono.

STANDARD PRODUTTIVI COSTANTI NEL TEMPO

La qualità è importante per noi! Sottoponiamo la nostra produzione a rigorosi controlli e seguiamo scrupolosamente processi produttivi che assicurano la costanza delle caratteristiche colorimetriche e dimensionali nel tempo. Un "quality control" severo al confezionamento e la spedizione accurata permettono al cliente di contare su standard qualitativi costanti nel tempo.

CONFORMITÀ ALLE NORMATIVE

Prendiamo seriamente il nostro lavoro! In qualità di leader di mercato operiamo nel pieno rispetto delle normative di riferimento (UNI EN ISO7010 - D.Lgs.81 Direttiva CEE 92/58) e aggiorniamo costantemente i codici di nostra produzione. Siamo l'unica azienda in Italia a poter assicurare la disponibilità e la conformità di tutti i cartelli alla normativa UNI EN ISO7010. Per facilità di consultazione, le normative sono riportate in fondo alle pagine di segnaletica.

DISTANZA DI LETTURA

Anche questo è un elemento importante di valutazione. Nel comparare le dimensioni dei cartelli dei diversi fabbricanti, si deve prendere in considerazione solo l'area totale del segnale (pittogramma e forma geometrica) e non quella del supporto o del testo. Questo elemento diventa importante al fine di decidere la distanza massima di lettura secondo normativa. Contatta il nostro Servizio Tecnico.



LA NORMA UNI EN ISO 7010

COS'È LA ISO 7010?

È una norma che contiene una raccolta di simboli registrati ed armonizzati riconosciuti universalmente. Alcuni di questi simboli sono noti, altri totalmente nuovi e su alcuni di questi sono stati effettuati test di comprensibilità in paesi Europei ed extraeuropei. Periodicamente vengono registrati nuovi pittogrammi.

PERCHÈ È STATA CREATA?

A causa di un sempre maggior numero di lavoratori di diversa madrelingua, le istruzioni ed informazioni di sicurezza basate sul testo non sono state più giudicate sufficienti. Si è pertanto creato uno standard internazionale per i segnali di sicurezza che utilizzasse solo pittogrammi che potessero essere facilmente compresi indipendentemente dalla lingua, cultura o abilità.

LO STATO DELLA ISO 7010

L'UNI ha pubblicato la norma in data 18/10/2012, ritirando contestualmente le norme nazionali corrispondenti (UNI). In data 16 luglio 2013 è stata emanata la circolare n. 30 del Ministero del Lavoro che chiarisce che l'utilizzo dei segnali di sicurezza previsti dalla norma UNI EN ISO 7010 non è in contrasto con l'allegato XXV - D. Lgs. 81, in quanto le differenze tra i segnali previsti dalle due fonti normative "non equivocano il significato" e sono, di fatto, "equivalenti". In merito all'utilizzo di segnali presenti nella norma UNI, e non presenti nell'allegato XXV, la circolare ne consente esplicitamente l'utilizzo: "Qualora sia necessario fornire mediante la segnaletica di sicurezza indicazioni relative a situazioni di rischio non considerate negli allegati da XXIV a XXXII, il datore di lavoro, anche in riferimento alle norme di buona tecnica, adotta le misure necessarie, secondo le particolarità del lavoro, l'esperienza e la tecnica".

ISO 7010



D. LGS 81

PERICOLO: SIGNIFICATO DEI SIMBOLI



PERICOLO
GENERICO
W001 ●



PERICOLO
MATERIALE
ESPLOSIVO
W002 ●



PERICOLO MATERIALE
RADIOATTIVO
O RADIAZIONI
IONIZZANTI
W003 ●



PERICOLO
RAGGIO LASER
W004 ●



PERICOLO
RADIAZIONI
NON IONIZZANTI
W005 ●



PERICOLO
CAMPO
MAGNETICO
W006 ●



PERICOLO
OSTACOLO
IN BASSO
W007 ●



PERICOLO
DI CADUTA
CON DISLIVELLO
W008 ●



PERICOLO
RISCHIO
BIOLOGICO
W009 ●



PERICOLO BASSA
TEMPERATURA/
CONDIZIONI DI
CONGELAMENTO
W010 ●



PERICOLO DI
SCIVOLAMENTO
W011 ●



PERICOLO
ELETTRICITÀ
W012 ●



PERICOLO
CANE DA
GUARDIA
W013 ●



PERICOLO
CARRELLI ELEVATORI
ED ALTRI VEICOLI
INDUSTRIALI
W014 ●



PERICOLO
CARICHI SOSPESI
W015 ●



PERICOLO
SOSTANZE
TOSSICHE
W016 ●



PERICOLO
SUPERFICIE
CALDA
W017 ●



PERICOLO
DI AVVIAMENTO
AUTOMATICO
W018 ●



PERICOLO DI
SCHIACCIAMENTO
W019 ●



PERICOLO
OSTACOLO
IN ALTO
W020 ●



PERICOLO
MATERIALE
INFIAMMABILE
W021 ●



PERICOLO
OGGETTO
AFFILATO
W022 ●



PERICOLO
SOSTANZE
CORROSIVE
W023 ●



PERICOLO DI
SCHIACCIAMENTO
MANI
W024 ●



ATTENZIONE RULLI
ROTANTI/PERICOLO
DI TRASCINAMENTO
W025 ●



PERICOLO
BATTERIE IN FASE
DI CARICA
W026 ●



PERICOLO
RADIAZIONI
OTTICHE
W027 ●



PERICOLO
DI SOSTANZE
COMBURENTI
W028 ●



PERICOLO
BOMBOLA
PRESSURIZZATA
W029 ●



PERICOLO
SCHIACCIAMENTO
MANI TRA LA PRESSA
E L'UTENSILE
W030 ●



PERICOLO
SCHIACCIAMENTO
MANI TRA LA PRESSA
E IL MATERIALE
W031 ●



PERICOLO
MOVIMENTO
RAPIDO DEL PEZZO
IN LAVORAZIONE
SOTTO LA PRESSA
W032 ●



PERICOLO
FILO
SPINATO
W033 ●



PERICOLO
PRESENZA
TORO
W034 ●



PERICOLO
CADUTA
OGGETTI
W035 ●



PERICOLO
LUCERNARIO
FRAGILE
W036 ●



PERICOLO DI
ESSERE TRAVOLTI
DA UNA MACCHINA
CONTROLLATA
A DISTANZA DA
UN OPERATORE
W037 ●



PERICOLO
FORTE SUONO
IMPROVISO
W038 ●



PERICOLO
CADUTA
GHIACCIO
W039 ●



PERICOLO
CADUTA NEVE
DAI TETTI
W040 ●



PERICOLO
ATMOSFERA
ASFISSIANTE
W041 ●



PERICOLO
ARCO
ELETTRICO
W042 ●



PERICOLO
STRATO SOTTILE
DI GHIACCIO
W043 ●



PERICOLO SCIVOLO
DI ALAGGIO E VARO
DI UNA BARCA
W044 ●



PERICOLO ATTIVITÀ
ACQUATICHE
CON TRAINO
W045 ●



PERICOLO
IMBARCAZIONI
DA SURF
W046 ●



PERICOLO
ACQUE
PROFONDE
W047 ●



PERICOLO
ACQUE BASSE,
NON TUFFARSI
W048 ●



PERICOLO OGGETTI
SOMMERSI, NON
IMMEGERGERSI!
W049 ●



PERICOLO
IMPROVVISO CAMBIO
DELLA PROFONDITÀ
DELL'ACQUA
DELLA PISCINA
W050 ●



PERICOLO CIGLIO
SENZA BARRIERA
W051 ●



PERICOLO
PRECIPIZIO
W052 ●



PERICOLO
SCARPATA
INSTABILE
W053 ●



PERICOLO
SQUALI
W054 ●



PERICOLO
SCARICO ACQUE
FOGNARIE
W055 ●



PERICOLO
TSUNAMI
W056 ●



PERICOLO FORTE
CORRENTE
W057 ●



PERICOLO AREA
DESTINATA A
IMBARCAZIONI
W058 ●



PERICOLO
SAND YACHTING
W059 ●



PERICOLO
MAREE
W060 ●



PERICOLO
SABBIE MOBILI,
FANGO O LIMO
W061 ●



PERICOLO
KITE SURFING
W062 ●



PERICOLO
PARAPENDIO
W063 ●



PERICOLO
VENTO FORTE
W064 ●



PERICOLO
ONDE ALTE
W065 ●



PERICOLO
CAMBIAMENTO
REPENTINO
PROFONDITÀ
DELL'ACQUA
W066 ●



PERICOLO
COCCODRILLI,
ALLIGATORI
O CAIMANI
W067 ●



PERICOLO
CADUTA
IN ACQUA
W068 ●



PERICOLO
MEDUSE
W069 ●



PERICOLO
GRADINO
W070 ●



PERICOLO
SOSTANZE DANNOSE
PER LA SALUTE
W071 ●



PERICOLO
SOSTANZE DANNOSE
PER L'AMBIENTE
W072 ●



PERICOLO
AREA INCENDI
SU LARGA
SCALA
W073 ●



PERICOLO
AREA
TORNADO
W074 ●



PERICOLO
AREA
VULCANO
ATTIVO
W075 ●



PERICOLO
ZONA DI
COLATA
DETRITICA
W076 ●



PERICOLO
ZONA
ALLAGAMENTO
W077 ●



PERICOLO
ZONA DI FRANE
E SMOTTAMENTI
W078 ●



PERICOLO
DI CADUTA
APERTURA
NEL SUOLO
W079 ●



PERICOLO
DI COMANDO
A DISTANZA
W080 ●



PERICOLO
ORGANI
IN MOTO
W081 ●



PERICOLO
PASSAGGIO
VEICOLI
W082 ●



PERICOLO
VEICOLI
SU ROTAIA
W083 ●



PERICOLO
PROIEZIONI
DI SCHEGGE
W084 ●



PERICOLO
RADIAZIONI
DA SALDATURA
W085 ●



PERICOLO
SPRUZZI
INCANDESCENTI
W086 ●



PERICOLO
ROBOT
IN MOVIMENTO
W087 ●



PERICOLO
RUMORE
W088 ●



PERICOLO
SERVOSCALA
W089 ●



PERICOLO
ALTA
TEMPERATURA
W090 ●



PERICOLO
ESPLOSIONE
W091 ●



PERICOLO
SPAZIO
CONFINATO
W092 ●



CARTELLI DI PERICOLO

DIMENSIONI DEI CARTELLI DI PERICOLO



SIGLA FORMATO	LATO VIRTUALE "L"	SPESSORE ALLUMINIO	DISTANZA DI LETTURA	PREZZO ALLUMINIO PIANO	PREZZO PELLICOLA ADESIVA
K	140 mm	0,5 mm	4 metri	€ 5,10	€ 3,40
W	210 mm	0,5 mm	6 metri	€ 10,20	€ 4,80
X	350 mm	0,5 mm	10 metri	€ 15,60	-
Y	560 mm	0,7 mm	16 metri	€ 43,60	-
Z	812 mm	1 mm	23 metri	€ 84,00	-

MATERIALI A RICHIESTA

Segnaletica standard fornita in alluminio piano. Per altri materiali, indicare la sigla P, R o S dopo il codice + lettera formato (esempio E1101KR):

sigla P PVC rigido (dielettrico) spessore 1 mm. Minimo ordinabile 1 pezzo.

sigla R Rifrangente su supporto di alluminio. Minimo ordinabile 1 pezzo.

sigla S Pellicola autoadesiva (solo formato K). Minimo ordinabile 5 pezzi/multipli.



E1101 ▲

K W X Y



E1102 ▲

K W X



E1103 ▲

K W X



E1148 ▲

K W X



E1104 ▲

K W X



E1105 ▲

K W X



E1106 ▲

K W X Y



E1107 ▲

K W X Y



E1108 ▲

K W X Y Z



E1109 ▲

K W X Y Z



E1110 ▲

K W X



E1114 ▲

K W X



1123

K W X Y



E1137 ▲

K W X



E1138 ▲

K W X



E1144 ▲

K W X



E1143 ▲

K W X



E1115 ▲

X



E1116 ▲

K W X



1117

K X Y



E1118 ▲ K X



E1146 ▲ K W X



E1112 ▲ K W X



1120 K W X Y



1121 X Y



1122 K X Y



E1147 ▲ K W X



1124 ▲ K W X Y



1125 ▲ K X Y



1126 ▲ X Y



E1127 ▲ * K X



E1128 ▲ * K W X



1129 K W X



E1130 ▲ K X



E1131 ▲ K X



1132 ▲ K W X Y



1133 ▲ W X



E1136 ▲ K X



E1139 ▲ K W X



1140 ▲ K



E1142 ▲ K X



E1145 ▲ W X



1150 K W X



1175 K W X



E1176 ▲ K



E1177 ▲ K X



E1178 ▲ K



E1179 ▲ K



E1180 ▲ K



E1181 ▲ K



E1182 ▲ K



E1183 ▲ K



E11903 X * - alluminio spessore 0,7, distanza di lettura 4 m
 ER11903 X * - come E11903X, versione rifrangente

€ 18,40

€ 26,80

* Simboli contenuti nel D. Lgs. 81 del 09/04/08 Titolo V

▲ Simboli contenuti nella Norma ISO 7010



CARTELLI DI PERICOLO

DIMENSIONI DEI CARTELLI DI PERICOLO



K - 350 x 125
H - 833 x 333



X - 333 x 500
Y - 500 x 700

SIGLA FORMATO	DIMENSIONI (b x h)	SPESSORE ALLUMINIO	DISTANZA DI LETTURA	PREZZO ALLUMINIO PIANO	PREZZO PELLICOLA ADESIVA
K	350 x 125 mm	0,5 mm	4 metri	€ 6,90	€ 4,80
X	333 x 500 mm	0,7 mm	10 metri	€ 20,80	-
H	833 x 333 mm	0,7 mm	10 metri	€ 53,20	-
Y	500 x 700 mm	1 mm	16 metri	€ 66,00	-

MATERIALI A RICHIESTA

Segnaletica standard fornita in alluminio piano. Per altri materiali, indicare la sigla P, R o S dopo il codice + lettera formato (esempio E1704XR):

sigla P PVC rigido (dielettrico) spessore 1 mm. Minimo ordinabile 1 pezzo.

sigla R Rifrangente su supporto di alluminio. Minimo ordinabile 1 pezzo.

sigla S Pellicola autoadesiva (solo formato K). Minimo ordinabile 5 pezzi/multipli.



ELEVATA RESISTENZA E DURATA DEI MATERIALI. VEDI CARATTERISTICHE A PAGINA 24.

CODICE DEL CARTELLO

FORMATI DISPONIBILI



E1704

K X



E1705

K X



E1706

K X



E1707

K X



E1708

K X



E1709

K X Y



E1773

K X



E1779

K X



E1780

K X



E1791

X



E1793

K



E1794

K



E17106

X



E17107

X H



E17113

K



E17114

K



E17115

K



E17330

K



E17125

K



E17126

K



E17135

K



 **ATTENZIONE
APPARECCHI
IN PRESSIONE**

E17138 K

 **ATTENZIONE
GRIGLIE NON
CALPESTABILI**

E17142 K

 **ATTENZIONE
FABBRICATO
PERICOLANTE**

E17145 X

 **ATTENZIONE
IMPIANTO
IN ESERCIZIO**

E17151 K X

 **ATTENZIONE
ALLA TRAVE**

E17153 K

 **ATTENZIONE
MATERIALI
INFIAMMABILI**

E1710 K X

 **ATTENZIONE
LIQUIDI
INFIAMMABILI**

E1711 K X Y

 **PERICOLO
D'INCENDIO**

E1712 K X

 **ATTENZIONE
GAS
INFIAMMABILI**

E1713 K X

 **PROPANO**

E1796 K

 **PERICOLO
D'INCENDIO
GASOLIO**

E17112 K X

 **IDROGENO**

E17118 K

 **METANO**

E17136 K

 **ATTENZIONE
GAS
ESPLOSIVO**

E1714 K X

 **ATTENZIONE
MATERIALE
ESPLOSIVO**

E1715 K

 **PERICOLO
ESPLOSIVI**

E1716 K

 **ATTENZIONE
PERICOLO DI
ESPLOSIONE**

E17130 K

 **ATTENZIONE
SOSTANZE
VELENOSE**

E1718 K X

 **PERICOLO
DI
INTOSSICAZIONE**

E1719 K

 **ATTENZIONE
ZONA
AVVELENATA**

E17146 K

 **ATTENZIONE
SOSTANZE
CORROSIVE**

E1720 K X

 **ATTENZIONE
LIQUIDI
CORROSIVI**

E1721 K X

 **ATTENZIONE
MATERIALE
RADIOATTIVO**

E1722 K X

 **ATTENZIONE
ZONA
SORVEGLIATA**

E1723 K X

 **ATTENZIONE
ZONA
CONTROLLATA**

E1726 K X

 **PERICOLO
MATERIALE
CONTAMINATO**

E1727 K X

 **ATTENZIONE
RADIAZIONI
IONIZZANTI**

E17104 X



CARTELLI DI PERICOLO

DIMENSIONI DEI CARTELLI DI PERICOLO



K - 350 x 125
H - 833 x 333



X - 333 x 500
Y - 500 x 700

SIGLA FORMATO	DIMENSIONI (b x h)	SPESSORE ALLUMINIO	DISTANZA DI LETTURA	PREZZO ALLUMINIO PIANO	PREZZO PELLICOLA ADESIVA
K	350 x 125 mm	0,5 mm	4 metri	€ 6,90	€ 4,80
X	333 x 500 mm	0,7 mm	10 metri	€ 20,80	-
H	833 x 333 mm	0,7 mm	10 metri	€ 53,20	-
Y	500 x 700 mm	1 mm	16 metri	€ 66,00	-

MATERIALI A RICHIESTA

Segnaletica standard fornita in alluminio piano. Per altri materiali, indicare la sigla P, R o S dopo il codice + lettera formato (esempio E1729XS):

sigla P PVC rigido (dielettrico) spessore 1 mm. Minimo ordinabile 1 pezzo.

sigla R Rifrangente su supporto di alluminio. Minimo ordinabile 1 pezzo.

sigla S Pellicola autoadesiva (solo formato K). Minimo ordinabile 5 pezzi/multipli.



ELEVATA RESISTENZA E DURATA DEI MATERIALI. VEDI CARATTERISTICHE A PAGINA 24.

CODICE DEL CARTELLO

FORMATI DISPONIBILI



E1728

K X Y



E1729

K X



E1731

K X



E1733

K



E1734

K X Y



E1735

K X



E1736

K X



E1737

K X



E1739

K X



E1740

K



E1741

K X



E1742

K



E1743

K X



E1744

K



E1745

K



E1746

K X



E1747

K X



E1748

K X



E1749

K X



E1772

K



E1774

K



E1775 K X



E1776 K



E1778 K



E1781 K X



E1782 K X



E1783 K



E1798 K



E17071 K X



E17101 K



E17102 K



E17103 K



E17109 K



E17110 K



E17111 K



E17120 K



E17129 K



E17154 K X



E1751 K X H Y



E1777 K X Y



E1785 X



E1786 X



E1752 K X Y



E1753 K X H Y



E1754 K X H Y



E1784 K X



E1755 K X



E17143 K



E1759 K X Y



1768 K X



17116 K



CARTELLI DI PERICOLO

DIMENSIONI DEI CARTELLI DI PERICOLO



K - 350 x 125
H - 833 x 333



X - 333 x 500
Y - 500 x 700

SIGLA FORMATO	DIMENSIONI (b x h)	SPESSORE ALLUMINIO	DISTANZA DI LETTURA	PREZZO ALLUMINIO PIANO	PREZZO PELLICOLA ADESIVA
K	350 x 125 mm	0,5 mm	4 metri	€ 6,90	€ 4,80
X	333 x 500 mm	0,7 mm	10 metri	€ 20,80	-
H	833 x 333 mm	0,7 mm	10 metri	€ 53,20	-
Y	500 x 700 mm	1 mm	16 metri	€ 66,00	-

MATERIALI A RICHIESTA

Segnaletica standard fornita in alluminio piano. Per altri materiali, indicare la sigla P, R o S dopo il codice + lettera formato (esempio E1758XP):

sigla P PVC rigido (dielettrico) spessore 1 mm. Minimo ordinabile 1 pezzo.

sigla R Rifrangente su supporto di alluminio. Minimo ordinabile 1 pezzo.

sigla S Pellicola autoadesiva (solo formato K). Minimo ordinabile 5 pezzi/multipli.



ELEVATA RESISTENZA E DURATA DEI MATERIALI. VEDI CARATTERISTICHE A PAGINA 24.

CODICE DEL CARTELLO

FORMATI DISPONIBILI



17139

X

PERICOLO DI CADUTA E ANNEGAMENTO



E1757

K X

PERICOLO DI CADUTA



E1758

K X

PERICOLO DI CADUTA ciglio di scavo



E17105

K

ATTENZIONE OLTRE LA LINEA GIALLA PERICOLO DI CADUTA DALL'ALTO



E17128

K

CADUTA CON DISLIVELLO



E17144

K

PERICOLO DI CADUTA DALL'ALTO



E17149

X

PERICOLO DI CADUTA limite di sicurezza



E17127

K X

PERICOLO DI INCIAMPO



E17148

K X

ATTENZIONE GRADINO



E17134

K

ATTENZIONE ALLA TESTA



E17832

K

ATTENZIONE ATMOSFERA POTENZIALMENTE ASFISSIANTE



E1760

K X

ATTENZIONE ALLE MANI



1761

K X

ATTENZIONE MACCHINA COMANDATA A DISTANZA



1789

K

ATTENZIONE MACCHINA AD AVVIAMENTO AUTOMATICO CON COMANDO A DISTANZA



E1762

K X

ATTENZIONE SOSTANZE COMBURENTI



E1797

K X

OSSIGENO



E17137

K X

PERICOLO DI TAGLIO



1765

K X

ATTENZIONE ORGANI IN MOVIMENTO



1766

K X H Y

ATTENZIONE PASSAGGIO VEICOLI



1767

K X

PERICOLO VEICOLI SU ROTAIA



1769

K X

ATTENZIONE PROIEZIONE DI SCHEGGE



ATTENZIONE
PROIEZIONE
DI SCAGLIE
INCANDESCENTI

1788 X

PERICOLO
DI RADIAZIONI
ULTRAVIOLETTE
DA SALDATURA

1770 K X

PERICOLO
DI SPRUZZI
DI LIQUIDO
INCANDESCENTE

1771 K X

ONDE NON
IONIZZANTI

E17141 K

ATTENZIONE
ACCUMULATORI

E17133 K X

PERICOLO
BIOLOGICO

E17117 K X

ATTENZIONE
IN QUESTA AREA
IL RUMORE
PUÒ SUPERARE
GLI 85 dB(A)

17132 K X

BASSA
TEMPERATURA

E17152 K

PERICOLO DI
SCOTTATURE
colla a caldo

E17121 K

MATERIALI
A TEMPERATURE
ELEVATE

E17122 K X

ATTENZIONE
TEMPERATURE
PERICOLOSE

E17123 K X

PERICOLO
DI
USTIONE

E17124 K X

ATTENZIONE
PARETI CALDE

E17131 K X

ATTENZIONE
SUPERFICI
CALDE

E17440 K

MACCHINA
AD AVVIAMENTO
AUTOMATICO

E1701 K X

MOTORE
AD AVVIAMENTO
AUTOMATICO

E1702 K X

IMPIANTO
AD AVVIAMENTO
AUTOMATICO

E1703 K X

ATTENZIONE
AMBIENTE CONFINATO

17840 K

ATTENZIONE
AMBIENTE CONFINATO
per accedere all'interno
fare riferimento alla
procedura relativa

17841 K

PERICOLO
ESPLOSIONE
DANGER
EXPLOSION

17155 K X

ATTENZIONE
CADUTA
MATERIALI
DALL'ALTO

E1756 K X Y

ATTENZIONE
BORDO DELLA
SCOGLIERA
INSTABILE

17502 K

SCHIACCIAMENTO MANI
TRA LA PRESSA
E L'UTENSILE

E17811 K

SCHIACCIAMENTO MANI
TRA LA PRESSA
E IL MATERIALE

E17821 K

PERICOLO MOVIMENTO
RAPIDO DEL PEZZO
IN LAVORAZIONE
SOTTO LA PRESSA

E17831 K

PRESENZA
DI CORRENTI
FORTI

17501 K

PERICOLO
BORDO NON
PROTETTO

17500 K

PERICOLO
CADUTA NEVE
DAI TETTI

E17361 K

ATTENZIONE
raggi
ultravioletti

E17451 K

RAGGI UV-C GERMICIDI
l'esposizione
diretta
o riflessa è dannosa

E17452 K



CARTELLI DI PERICOLO

DIMENSIONI DEI CARTELLI DI PERICOLO



cod. 44...

CODICE	DIMENSIONI (b x h)	SPESORE ALLUMINIO	DISTANZA DI LETTURA	PREZZO ALLUMINIO PIANO	PREZZO PELLICOLA ADESIVA
E40....K	145 x 145 mm	0,7 mm	4 metri	€ 8,30	€ 4,80
E41....K	145 x 164 mm	0,7 mm	4 metri	€ 9,00	€ 5,10
E44....K	145 x 182 mm	0,7 mm	4 metri	€ 9,70	€ 6,00
E40....W	220 x 220 mm	0,7 mm	6 metri	€ 14,40	-
E41....W	220 x 250 mm	0,7 mm	6 metri	€ 15,60	-
E44....W	220 x 280 mm	0,7 mm	6 metri	€ 18,80	-
E40....X	360 x 360 mm	0,7 mm	10 metri	€ 30,00	-
E41....X	360 x 400 mm	0,7 mm	10 metri	€ 34,00	-
E44....X	360 x 450 mm	0,7 mm	10 metri	€ 34,00	-
E40....Y	580 x 580 mm	0,7 mm	16 metri	€ 65,00	-
E41....Y	580 x 650 mm	0,7 mm	16 metri	€ 74,40	-
E44....Y	580 x 730 mm	0,7 mm	16 metri	€ 74,40	-

MATERIALI A RICHIESTA

Segnaletica standard fornita in alluminio piano. Per altri materiali, indicare la sigla P, R o S dopo il codice + lettera formato (esempio E400100KR):

sigla P PVC rigido (dielettrico) spessore 1 mm. Minimo ordinabile 1 pezzo.

sigla R Rifrangente su supporto di alluminio. Minimo ordinabile 1 pezzo.

sigla S Pellicola autoadesiva (solo formato K). Minimo ordinabile 5 pezzi/multipli.

i I CARTELLI DELLE SERIE 40..., 41... E 44... POSSONO ESSERE REALIZZATI CON SCRITTE DIVERSE (MAGGIORI INFORMAZIONI A PAGINA 20).

CODICE DEL CARTELLO FORMATI DISPONIBILI



E400100 K W X Y E400101 K W X Y E400102 XY



E400103 X E400106 X E400107 X



E400108 X E400111 X E400112 K



E400200 K X E400201 X E400202 K X



E400203 K X E400204 K W X E400205 K W X



E400301 X E400303 K X E400304 X E400305 X E400400 X E400401 X E400402 X



E400404 X E400405 W E400501 X E400502 K W X E400503 K E400601 X E400602 K

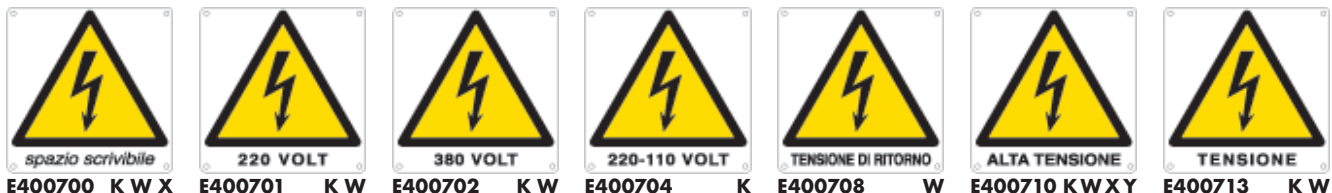

E400700 K W X E400701 K W E400702 K W E400704 K E400708 W E400710 K W X Y E400713 K W



PERICOLO DI FOLGORAZIONE
E400715 K W X



PERICOLO DI MORTE
E400716 K X



TENSIONI INTERCONNESSE
E400717 K



24 VOLT
E400719 K



IMPIANTO IN TENSIONE
E400721 K W X



15000 VOLT
E400722 K W



22000 VOLT
E400723 W



48 VOLT
E400724 K



12 VOLT
E400725 K



400 VOLT
E400726 K



230 VOLT
E400727 K



QUADRO SOTTO TENSIONE
E400728 K



CABINA ELETTRICA
E400729 K



CARICHI SOSPESI
E400801 K W X Y



CARRELLI ELEVATORI
E400901 X Y



PASSAGGIO CARRELLI
E400902 K X Y



CARRELLI IN MOVIMENTO
E400903 W X Y



PAVIMENTO SCIVOLOSO
E401401 K W X Y



APERTURA NEL SUOLO
402301 K W X Y



PERICOLO DI CADUTA
E401301 K X Y



CADUTA CON DISLIVELLO
E403801 W



PERICOLO D'INCIAMPO
E403701 X



CAMPO MAGNETICO
E402701 W X



PERICOLO BIOLOGICO
E403101 K X



ATTENZIONE ALLE MANI
E401601 K W X



MATERIALE COMBURENTE
E401801 X



ORGANI IN MOTO
402001 K X Y



TRANSITO VAGONI
402201 X



VEICOLI SU ROTAIA
402202 X Y



PROIEZIONE SCHEGGE
402401 X Y



SUPERIORE a 85 dB(A)
403201 W X



PERICOLO RUMORE
403202 W



SERVOSCALA IN MOVIMENTO
403301 W



BASSA TEMPERATURA
E403601 X



ALTA TEMPERATURA
E403901 K W X Y



PERICOLO DI USTIONE
E403902 K



VAPORE ALTA TEMPERATURA
E403903 K



AVVIAMENTO AUTOMATICO
E400104 W X



CADUTA MATERIALI
E401101 X Y



PERICOLO FILO SPINATO
E40791 W



PERICOLO PRESENZA TORO
E40801 W



RADIAZIONI
ZONA CONTROLLATA
E410601 K W X



RADIAZIONI
ZONA SORVEGLIATA
E410602 K X



RADIAZIONI IONIZZANTI
CRITICITÀ
416101 X



RADIAZIONI IONIZZANTI
IRRADIAZIONI
416201 X



CONTAMINAZIONE
RADIOATTIVA
416301 K X



ATTENZIONE
CAVI ELETTRICI
E410701 W X





CARTELLI DI PERICOLO

DIMENSIONI DEI CARTELLI DI PERICOLO



cod. 44...

CODICE	DIMENSIONI (b x h)	SPESORE ALLUMINIO	DISTANZA DI LETTURA	PREZZO ALLUMINIO PIANO	PREZZO PELLICOLA ADESIVA
E40....K	145 x 145 mm	0,7 mm	4 metri	€ 8,30	€ 4,80
E41....K	145 x 164 mm	0,7 mm	4 metri	€ 9,00	€ 5,10
E44....K	145 x 182 mm	0,7 mm	4 metri	€ 9,70	€ 6,00
E40....W	220 x 220 mm	0,7 mm	6 metri	€ 14,40	-
E41....W	220 x 250 mm	0,7 mm	6 metri	€ 15,60	-
E44....W	220 x 280 mm	0,7 mm	6 metri	€ 18,80	-
E40....X	360 x 360 mm	0,7 mm	10 metri	€ 30,00	-
E41....X	360 x 400 mm	0,7 mm	10 metri	€ 34,00	-
E44....X	360 x 450 mm	0,7 mm	10 metri	€ 34,00	-
E40....Y	580 x 580 mm	0,7 mm	16 metri	€ 65,00	-
E41....Y	580 x 650 mm	0,7 mm	16 metri	€ 74,40	-
E44....Y	580 x 730 mm	0,7 mm	16 metri	€ 74,40	-

CODICE DEL CARTELLO FORMATI DISPONIBILI

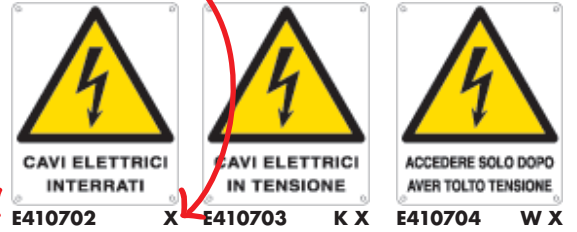

MATERIALI A RICHIESTA

Segnaletica standard fornita in alluminio piano. Per altri materiali, indicare la sigla P, R o S dopo il codice + lettera formato (esempio E440702XR):

sigla P PVC rigido (dielettrico) spessore 1 mm. Minimo ordinabile 1 pezzo.

sigla R Rifrangente su supporto di alluminio. Minimo ordinabile 1 pezzo.

sigla S Pellicola autoadesiva (solo formato K). Minimo ordinabile 5 pezzi/multipli.



i I CARTELLI DELLE SERIE 40., 41. E 44. POSSONO ESSERE REALIZZATI CON SCRITTE DIVERSE (MAGGIORI INFORMAZIONI A PAGINA 20).



NUOVA SEGNALETICA DI ADEGUAMENTO AL CLP (CLASSIFICATION, LABELLING AND PACKAGING): DIRETTIVA 2014/27/UE

Con questa Direttiva si vuole armonizzare il regolamento (CE) n. 1272/2008 (il cosiddetto Regolamento CLP - Classification, Labelling and Packaging) con la direttiva del Consiglio 92/58/CEE (prescrizioni minime per la segnaletica di sicurezza e/o di salute sul luogo di lavoro), che contiene ancora riferimenti al precedente sistema di classificazione e di etichettatura.

DIMENSIONI DEI CARTELLI DI SOSTANZE PERICOLOSE

CODICE	DIMENSIONI (b x h)	MATERIALE	TIPOLOGIA DI STAMPA	PREZZO
35..	300 x 200 mm	Alluminio piano 0,5	Stampa digitale su PVC sovra laminato con pellicola anti UV	€ 23,60
27..	500 x 333 mm	Alluminio piano 0,7		€ 44,80

Nome della sostanza

Frasi H (indicazioni di pericolo)

Nuovi pittogrammi secondo la specifica GHS

Frasi P (consigli di prudenza)

Numeri CAS e CE (se presenti)

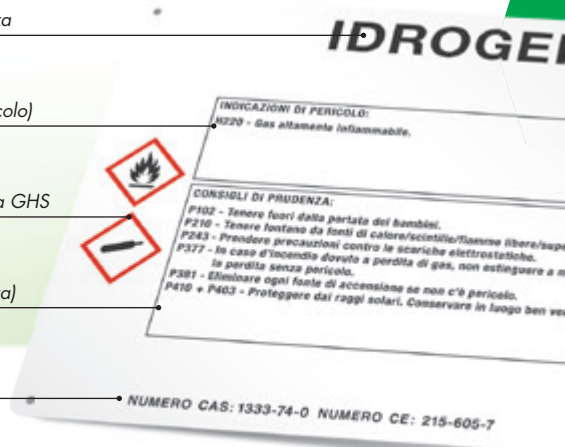

LA SEGNALETICA CLP (CLASSIFICATION, LABELLING AND PACKAGING) È REALIZZABILE, SENZA MINIMI QUANTITATIVI RICHIESTI, ANCHE SU SPECIFICA RICHIESTA DEI CLIENTI IN BASE ALLE SDS (SCHEDE DI SICUREZZA) DELLE SOSTANZE DA SEGNALARE. TALI SCHEDE DEVONO ESSERE AGGIORNATE AL REGOLAMENTO (CE) N. 1272/2008 E RIPORTARE CHIARAMENTE AL PUNTO 2.2 I PITTOGRAMMI E TUTTE LE FRASI H E P ESPRESSAMENTE INDICATE CHE IL CLIENTE VUOLE INSERIRE.

CODICI: CLP35... (300 x 200 mm) € 35,20 CLP27... (500 x 333 mm) € 67,00

 35A121	 27A121	 35B600	 27B600	 35B620	 27B620	 35B980	 27B980
 35A861	 27A861	 35B570	 27B570	 35B990	 27B990	 35B590	 27B590
 35B780	 27B780	 35B580	 27B580	 35F250	 27F250	 35B610	 27B610
 35A112	 27A112	 35A360	 27A360	 35A231	 27A231	 35A380	 27A380

I LE FRASI DELLE INDICAZIONI DI PERICOLO H O EUH SONO TRATTE DA DOCUMENTI UFFICIALI SULLA CLASSIFICAZIONE DELLE SOSTANZE MENTRE I CONSIGLI DI PRUDENZA P SONO TRATTI DALLA CLASSIFICAZIONE PRESENTE NEL REGOLAMENTO (CE) N. 1272/2008 NELLE FRASI S EVENTUALMENTE INTEGRATI DA FRASI ESTRATTE DA SDS DELLE STESSA SOSTANZE CHE HANNO FRA LE FONTI AUTOREVOLI ENTI O ORGANIZZAZIONI DI PUBBLICA UTILITÀ. È COMPITO DEL DATORE DI LAVORO VERIFICARE LA CORRISPONDENZA DEL CONTENUTO DEI SEGNALE CON LE SDS (SCHEDE DI SICUREZZA) SPECIFICHE DELLA SOSTANZA UTILIZZATA SUL LUOGO DI LAVORO ANCHE IN RELAZIONE A SPECIFICHE PROCEDURE AZIENDALI.



CARTELLI DI PERICOLO: STOCCAGGIO RIFIUTI E SOSTANZE PERICOLOSE

Cartelli per stoccaggio rifiuti

E27.. - in alluminio spessore 0,7, dimensioni mm 500 x 333

€ 31,00



E2752



E2756



E2782



E2783



E2784



E2789



E2790

Cartelli per sostanze pericolose

E27.. - in alluminio spessore 0,7, dimensioni mm 500 x 333

€ 31,00



ELEVATA RESISTENZA E DURATA DEI MATERIALI. CARATTERISTICHE A PAGINA 24.



E2701



E2703



E2704



E2705



E2706



E2708



E2710



E2711



E2715



E2716



E2721



E2727



E2728



E2731



E2733



E2739



E2740



E2743



E2747



E2748



E2765



E2767



E2768



E2769



E2770



E2773



E2778



E2779



E2780



E2781



E2786



OBBLIGO: SIGNIFICATO DEI SIMBOLI



OBBLIGO
GENERICO
M001 ●



È OBBLIGATORIO
LEGGERE
LE ISTRUZIONI
M002 ●



È OBBLIGATORIO
INDOSSARE
LE PROTEZIONI
DELL'UDITO
M003 ●



È OBBLIGATORIO
INDOSSARE
LE PROTEZIONI
DEGLI OCCHI
M004 ●



È OBBLIGATORIO
ASSICURARSI DEL COLLE-
GAMENTO
A TERRA
M005 ●



È OBBLIGATORIO
STACCARE
LA CORRENTE
M006 ●



È OBBLIGATORIO
INDOSSARE
OCCHIALI CON LENTI
OPACHE
M007 ●



È OBBLIGATORIO
INDOSSARE
LE CALZATURE
DI SICUREZZA
M008 ●



È OBBLIGATORIO
INDOSSARE
I GUANTI
PROTETTIVI
M009 ●



È OBBLIGATORIO
INDOSSARE
INDUMENTI
PROTETTIVI
M010 ●



È OBBLIGATORIO
LAVARSI LE MANI
M011 ●



È OBBLIGATORIO
USARE IL
CORRIMANO
M012 ●



È OBBLIGATORIO
INDOSSARE
LO SCHERMO
PROTETTIVO
M013 ●



È OBBLIGATORIO
INDOSSARE
IL CASCO
DI PROTEZIONE
M014 ●



È OBBLIGATORIO
INDOSSARE
INDUMENTI
AD ALTA
VISIBILITÀ
M015 ●



È OBBLIGATORIO
INDOSSARE
LA MASCHERA
M016 ●



È OBBLIGATORIO
INDOSSARE
IL RESPIRATORE
M017 ●



È OBBLIGATORIO
USARE
L'IMBRACATURA
DI SICUREZZA
M018 ●



È OBBLIGATORIO
INDOSSARE
LA MASCHERA
PER LA SALDATURA
M019 ●



È OBBLIGATORIO
INDOSSARE
LA CINTURA
DI SICUREZZA
M020 ●



È OBBLIGATORIO
DISCONNETTERE
IL MACCHINARIO
PRIMA DI EFFETTUARE
MANUTENZIONI
O RIPARAZIONI
M021 ●



È OBBLIGATORIO
USARE LA CREMA
BARRIERA
M022 ●



È OBBLIGATORIO
USARE IL PONTE
PEDONALE
M023 ●



È OBBLIGATORIO
UTILIZZARE IL
PERCORSO
PEDONALE
M024 ●



È OBBLIGATORIO
PROTEGGERE
I BAMBINI CON
OCCHIALI OPACHI
M025 ●



È OBBLIGATORIO
USARE IL
GREMBIULE
PROTETTIVO
M026 ●



È OBBLIGATORIO
CONTROLLARE
LE PROTEZIONI
M027 ●



È OBBLIGATORIO
TENERE
CHIUSO
M028 ●



È OBBLIGATORIO
SEGNALARE
L'AVVIAMENTO
M029 ●



È OBBLIGATORIO
VERSARE I RIFIUTI
NELL'APPOSITO
CONTENITORE
M030 ●



È OBBLIGATORIO
USARE LA
PROTEZIONE
REGOLABILE DELLA
SEGA CIRCOLARE
DA BANCO
M031 ●



È OBBLIGATORIO
INDOSSARE
LE CALZATURE
ANTISTATICHE
M032 ●



È OBBLIGATORIO
CHIUDERE LA BARRA
DI SICUREZZA
DELLA SEGGIOVIA
M033 ●



È OBBLIGATORIO
APRIRE LA BARRA
DI SICUREZZA
DELLA SEGGIOVIA
M034 ●



È OBBLIGATORIO
IN CASO DI CADUTA,
ABBANDONARE
IMMEDIATAMENTE
IL BINARIO
TRACCIATO.
M035 ●



È OBBLIGATORIO
ALZARE LE PUNTE
DEGLI SCI.
M036 ●



È OBBLIGATORIO
TENERE CHIUSI
I PORTELLI NELLA
PROCEDURA DI
LANCIO IN MARE
M037 ●



È OBBLIGATORIO
ACCENDERE IL
MOTORE NELLA
PROCEDURA
DI LANCIO
IN MARE.
M038 ●



È OBBLIGATORIO
CALARE LA SCIALUPPA
DI SALVATAGGIO
NELLA PROCEDURA
DI LANCIO IN MARE
M039 ●



È OBBLIGATORIO
CALARE IN ACQUA
LA ZATTERA DI
SALVATAGGIO NELLA
PROCEDURA DI
LANCIO IN MARE
M040 ●



È OBBLIGATORIO CALARE
IN ACQUA LA BARCA
DI SALVATAGGIO NELLA
PROCEDURA DI LANCIO
IN MARE
M041 ●



È OBBLIGATORIO
SGANCIARE NELLA
PROCEDURA DI
LANCIO IN MARE
M042 ●



È OBBLIGATORIO
ATTIVARE L'IMPIANTO
ANTINCENDIO
A SPRAY DI ACQUA
NELLA PROCEDURE
DI LANCIO IN MARE
M043 ●



È OBBLIGATORIO
ATTIVARE L'IMPIANTO
DI AERAZIONE NELLA
PROCEDURA DI LANCIO
IN MARE.
M044 ●



È OBBLIGATORIO
SGANCIARE LE FUNI
DI ANCORAGGIO
DELL'IMBARCAZIONE
DI SALVATAGGIO
NELLA PROCEDURA
DI LANCIO IN MARE
M045 ●



È OBBLIGATORIO
FISSARE LE
BOMBOLE
M046 ●



È OBBLIGATORIO
UTILIZZARE
L'APPARECCHIO
DI RESPIRAZIONE
AUTONOMA
M047 ●



È OBBLIGATORIO
UTILIZZARE IL
RILEVATORE
DI GAS
M048 ●



È OBBLIGATORIO
INDOSSARE I
DISPOSITIVI DI
PROTEZIONE PER PATTINI
A ROTELLE
M049 ●



È OBBLIGATORIO
SCENDERE
DAL TOBOGA
A SINISTRA
M050 ●



È OBBLIGATORIO
SCENDERE
DAL TOBOGA
A DESTRA
M051 ●



È OBBLIGATORIO
MANTENERE
LA DISTANZA
TRA I TOBOGA
M052 ●



È OBBLIGATORIO
INDOSSARE IL
GIUBBOTTO
SALVAGENTE
M053 ●



È OBBLIGATORIO
CONTROLLARE
I BAMBINI IN
ACQUA
M054 ●



È OBBLIGATORIO
TENERE FUORI
DALLA PORTATA
DEI BAMBINI
M055 ●



È OBBLIGATORIO
VENTILARE PRIMA
E DURANTE
L'ACCESSO
M056 ●



È OBBLIGATORIO
ASSICURARE
VENTILAZIONE
CONTINUA
M057 ●



È OBBLIGATORIO
ENTRARE
SOLO SOTTO
SUPERVISIONE
M058 ●



È OBBLIGATORIO
INDOSSARE IL
CAMICE DA
LABORATORIO
M059 ●



È OBBLIGATORIO
TENERE
SALDAMENTE
IL CARRELLO
M060 ●



È OBBLIGATORIO
PROCEDERE
A PASSO
D'UOMO
M061 ●



OBBLIGO
AI CARRELLI
DI PROCEDERE
A PASSO
D'UOMO
M062 ●



È OBBLIGATORIO
SPEGNERE
LE SIGARETTE
M063 ●



È OBBLIGATORIO
REGOLARE IL
POGGIAPEZZI
MOLA
M064 ●



OBBLIGO
PEDONI
A SINISTRA
M065 ●



OBBLIGO
PEDONI
A DESTRA
M066 ●



È OBBLIGATORIO
INDOSSARE
INDUMENTI
PROTETTIVI
M067 ●



È OBBLIGATORIO
INDOSSARE
LA CUFFIA
RACCOGLIACAPELLI
M068 ●



OBBLIGO
CARRELLI
ELEVATORI
M069 ●



OBBLIGO
PUNTO
D'AGGANCIO
M070 ●



CARTELLI DI OBBLIGO

DIMENSIONI DEI CARTELLI DI OBBLIGO



SIGLA FORMATO	DIMENSIONI (b x h)	SPESSORE ALLUMINIO	DISTANZA DI LETTURA	PREZZO ALLUMINIO PIANO	PREZZO PELLICOLA ADESIVA
K	115 x 115 mm	0,5 mm	4 metri	€ 5,40	€ 2,80
W	166 x 166 mm	0,5 mm	6 metri	€ 8,20	-
X	270 x 270 mm	0,5 mm	10 metri	€ 12,20	-
Y	435 x 435 mm	0,7 mm	16 metri	€ 40,40	-
Z	615 x 615 mm	1 mm	23 metri	€ 86,20	-

MATERIALI A RICHIESTA

Segnaletica standard fornita in alluminio piano. Per altri materiali, indicare la sigla P, R o S dopo il codice + lettera formato (esempio E1350K**S**):

sigla P PVC rigido (dielettrico) spessore 1 mm. Minimo ordinabile 1 pezzo.

sigla R Rifrangente su supporto di alluminio. Minimo ordinabile 1 pezzo.

sigla S Pellicola autoadesiva (solo formato K). Minimo ordinabile 5 pezzi/multipli.



**CODICE DEL
CARTELLO**

**FORMATI
DISPONIBILI**



E1350 ▲

K W X

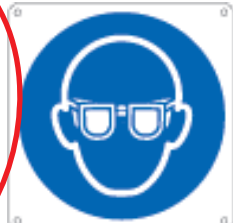

E1351 ▲

K W X Y



E1352 ▲

K W X Y Z



E1353 ▲

K W X



E1354 ▲

K W X Y



E1355 ▲

K W X Y



E1356 ▲

K W X Y



E1357 ▲

K



E1358 ▲

K W X



1359

W X Y Z



1360

X Y Z



E1361 ▲

K W X



E1362 ▲

K X Y

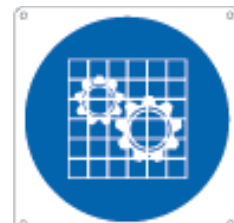

E1363 ▲

K W X Y



E1364 ▲

K W X



1365

K W X Y



E1367 ▲

K X



E1373 ▲

K X



1374

K W X



E1381 ▲

K W X



E1375 W X Y



1376 W X Y



E1377 ▲ W X



1378 K X Z



E1379 ▲ K W X Y



E1380 ▲ K



1382 K X



E1383 K W X



1384 K X



1385 K



E1386 ▲ K W X



E1387 ▲ K W X



E1388 ▲ K X



E1389 ▲ K W X



E1391 ▲ K



E1392 ▲ K W X Y



E1393 ▲ K W X Y



E1394 ▲ K



E1395 ▲ K W X



E1396 ▲ K W X



E1397 ▲ K X Y



E1398 ▲ K W X



E1399 ▲ K X



E13500 ▲ K



E13501 ▲ K



E13502 ▲ K

 ELEVATA RESISTENZA E DURATA DEI MATERIALI. VEDI LE CARATTERISTICHE A PAGINA 24.

- Simboli contenuti nella Norma UNI 7547
- * Simboli contenuti nel D. Lgs. 81 del 09/04/08 Titolo V
- ▲ Simboli contenuti nella Norma ISO 7010



CARTELLI DI OBBLIGO

DIMENSIONI DEI CARTELLI DI OBBLIGO



K - 350 x 125
H - 765 x 270



X - 333 x 500
Y - 500 x 700

SIGLA FORMATO	DIMENSIONI (b x h)	SPESSORE ALLUMINIO	DISTANZA DI LETTURA	PREZZO ALLUMINIO PIANO	PREZZO PELLICOLA ADESIVA
K	350 x 125 mm	0,5 mm	4 metri	€ 7,00	€ 4,80
X	333 x 500 mm	0,7 mm	10 metri	€ 20,80	-
H	765 x 270 mm	0,7 mm	10 metri	€ 40,40	-
Y	500 x 700 mm	1 mm	16 metri	€ 66,00	-

MATERIALI A RICHIESTA

Segnaletica standard fornita in alluminio piano. Per altri materiali, indicare la sigla P, R o S dopo il codice + lettera formato (esempio E1918KR):

sigla P PVC rigido (dielettrico) spessore 1 mm. Minimo ordinabile 1 pezzo.

sigla R Rifrangente su supporto di alluminio. Minimo ordinabile 1 pezzo.

sigla S Pellicola autoadesiva (solo formato K). Minimo ordinabile 5 pezzi/multipli.



ELEVATA RESISTENZA E DURATA DEI MATERIALI. VEDI CARATTERISTICHE A PAGINA 24.

CODICE DEL CARTELLO **FORMATI DISPONIBILI**

E1918 **K X** **E1924** **K X** **E1926** **K**

E1927 **K X** **E1928** **K** **E1934** **K**

E1935 **X** **E1936** **X** **E1942** **H**

E1960 **K** **E1961** **K** **E1962** **K**

E1967 **Y** **E1968** **K** **E1974** **K**

E19994 **K X** **E19996** **X** **E19997** **K**

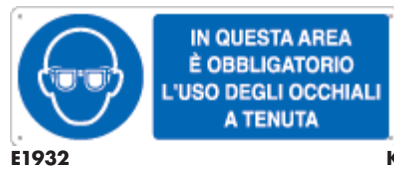



CARTELLI DI OBBLIGO

DIMENSIONI DEI CARTELLI DI OBBLIGO



K - 350 x 125
H - 765 x 270



X - 333 x 500
Y - 500 x 700

SIGLA FORMATO	DIMENSIONI (b x h)	SPESSORE ALLUMINIO	DISTANZA DI LETTURA	PREZZO ALLUMINIO PIANO	PREZZO PELLICOLA ADESIVA
K	350 x 125 mm	0,5 mm	4 metri	€ 7,00	€ 4,80
X	333 x 500 mm	0,7 mm	10 metri	€ 20,80	-
H	765 x 270 mm	0,7 mm	10 metri	€ 40,40	-
Y	500 x 700 mm	1 mm	16 metri	€ 66,00	-

MATERIALI A RICHIESTA

Segnaletica standard fornita in alluminio piano. Per altri materiali, indicare la sigla P, R o S dopo il codice + lettera formato (esempio E1909XP):

sigla P PVC rigido (dielettrico) spessore 1 mm. Minimo ordinabile 1 pezzo.

sigla R Rifrangente su supporto di alluminio. Minimo ordinabile 1 pezzo.

sigla S Pellicola autoadesiva (solo formato K). Minimo ordinabile 5 pezzi/multipli.



ELEVATA RESISTENZA E DURATA DEI MATERIALI. VEDI CARATTERISTICHE A PAGINA 24.

CODICE DEL CARTELLO **FORMATI DISPONIBILI**

1909	K X Y	1910	K X H Y	1971	Y
E1911	K X	E1958	K	E1912	K X
E1917	K X Y	E1937	X	E1913	K X
E1914	K X	E1915	K	E1963	K
1916	K X	1919	K X	E1921	K X
1920	K X	E1956	K X	E1946	K X





CARTELLI DI OBBLIGO

DIMENSIONI DEI CARTELLI DI OBBLIGO



cod. 61...



cod. 62...



cod. 63...

CODICE	DIMENSIONI (b x h)	DISTANZA DI LETTURA	SPESSORE ALLUMINIO	PREZZO ALLUMINIO PIANO	PREZZO PELLICOLA ADESIVA
E61.....K	115 x 140 mm	4 metri	0,7 mm	€ 9,40	€ 5,40
E62.....K	115 x 160 mm	4 metri	0,7 mm	€ 9,50	€ 5,60
E63.....K	115 x 178 mm	4 metri	0,7 mm	€ 9,90	€ 5,80
E61.....W	166 x 210 mm	6 metri	0,7 mm	€ 13,40	-
E62.....W	166 x 233 mm	6 metri	0,7 mm	€ 13,60	-
E63.....W	166 x 262 mm	6 metri	0,7 mm	€ 14,40	-
E61.....X	270 x 330 mm	10 metri	0,7 mm	€ 20,40	-
E62.....X	270 x 370 mm	10 metri	0,7 mm	€ 21,20	-
E63.....X	270 x 430 mm	10 metri	0,7 mm	€ 24,60	-
E61.....Y	435 x 530 mm	16 metri	0,7 mm	€ 49,00	-
E62.....Y	435 x 603 mm	16 metri	0,7 mm	€ 52,20	-
E63.....Y	435 x 678 mm	16 metri	0,7 mm	€ 59,60	-

CODICE DEL CARTELLO FORMATI DISPONIBILI



PROTEGGERE GLI OCCHI
E615101 K W X Y



CASCO PROTETTIVO
E615201 K W X Y



GUANTI PROTETTIVI
E615401 K W X Y



CALZATURE PROTETTIVE
E615501 K W X Y



PROTEGGERE L'UDITO
E615601 K W X Y



SCHERMO PROTETTIVO
E615801 K X



A PASSO D'UOMO
615901 W X Y



A PASSO D'UOMO
616001 X Y

MATERIALI A RICHIESTA

Segnaletica standard fornita in alluminio piano. Per altri materiali, indicare la sigla P, R o S dopo il codice + lettera formato (esempio E615101WP):

sigla P PVC rigido (dielettrico) spessore 1 mm. Minimo ordinabile 1 pezzo.

sigla R Rifrangente su supporto di alluminio. Minimo ordinabile 1 pezzo.

sigla S Pellicola autoadesiva (solo formato K). Minimo ordinabile 5 pezzi/multipli.



INDUMENTI PROTETTIVI
E616101 K X



LAVARSI LE MANI
E616401 X Y



SPEGNERE LE SIGARETTE
616501 W X Y



PEDONI A DESTRA
617501 W Y



PEDONI A SINISTRA
617601 W Y



CINTURA DI SICUREZZA
E617901 K X Y



TENERE CHIUSO
E615701 K



USARE UTENSILI ANTISCINTILLA
E625001 K X



USARE I DISPOSITIVI DI PROTEZIONE PREVISTI
E625002 W



PROTEGGERE LE VIE RESPIRATORIE
E625301 K X Y



È OBBLIGATORIO L'USO DI GUANTI DIELETRICI
E625401 W



PROTEGGERE L'UDITO CON CUFFIA ANTIRUMORE O TAPPI
E625601 X Y



SEGNALARE PRIMA DI METTERE IN MOTO
E626201 X Y



PASSAGGIO OBBLIGATORIO PER I PEDONI
E628101 K



INDOSSARE LA CUFFIA RACCHIUDI CAPELLI
628201 K



SEGNALARE SUBITO, DIFETTI O GUASTI DELLA MACCHINA
E635004 K



LASCIARE LIBERI I PASSAGGI E LE USCITE
E635005 K X



OBBLIGO DI ESPORRE LA TESSERA DI RICONOSCIMENTO Art. 20 D.Lgs. 91 del 09/04/08
E635007 X



i I CARTELLI DELLE SERIE 61..., 62... E 63... POSSONO ESSERE REALIZZATI CON SCRITTE DIVERSE. MAGGIORI INFORMAZIONI A PAGINA 20.

Cartelli di obbligo multisimbolo

LE PRIME DUE CIFRE DEL CODICE IDENTIFICANO IL FORMATO			
CODICE	FORMATO	MATERIALE	PREZZO
E26...	500 x 333 mm	Alluminio spessore 0,7 mm	€ 22,60
E31...	300 x 200 mm	Alluminio spessore 0,5 mm	€ 9,70

⚡ ELEVATA RESISTENZA E DURATA DEI MATERIALI. VEDI CARATTERISTICHE A PAGINA 24.



E2650

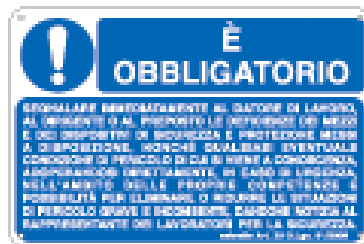

E2651



E2652

E3122



E2653



E2654



E2655



E2656

E3123



E2657

E3127



E2659

DIVIETO: SIGNIFICATO DEI SIMBOLI



DIVIETO
GENERICO
P001 ●



VIETATO
FUMARE
P002 ●



VIETATO FUMARE
O USARE
FIAMME LIBERE
P003 ●



DIVIETO
DI TRANSITO
AI PEDONI
P004 ●



VIETATO
BERE ACQUA
NON POTABILE
P005 ●



VIETATO L'ACCESSO
A CARRELLI ELEVATORI
E ALTRI VEICOLI
INDUSTRIALI
P006 ●



VIETATO L'ACCESSO
AI PORTATORI
DI STIMOLATORI
CARDIACI ATTIVI
P007 ●



VIETATO ENTRARE
CON OROLOGI
ED OGGETTI
METALLICI
P008 ●



VIETATO
ARRAMPICARSI
SUGLI SCAFFALI
P009 ●



VIETATO
TOCCARE
P010 ●



VIETATO
SPEGNERE
CON ACQUA
P011 ●



VIETATO
APPOGGIARE
CARICHI PESANTI
P012 ●



VIETATO TENERE
I TELEFONI
ACCESI
P013 ●



VIETATO L'ACCESSO
AI PORTATORI DI
PROTESI METALLICHE
P014 ●



VIETATO
INTRODURRE
LE MANI
P015 ●



VIETATO USARE
GETTI D'ACQUA
P016 ●



VIETATO
SPINGERE
P017 ●



VIETATO
SEDERSI
P018 ●



VIETATO
SALIRE
P019 ●



VIETATO L'USO
DELL'ASCENSORE
IN CASO
DI INCENDIO
P020 ●



VIETATO
L'ACCESSO
AI CANI
P021 ●



VIETATO
MANGIARE
O BERE
P022 ●



VIETATO
OSTRUIRE
IL PASSAGGIO
P023 ●



VIETATO CALPESTARE
O SOSTARE IN
QUESTA ZONA
P024 ●



VIETATO L'USO
DI QUESTA
IMPALCATURA
INCOMPLETA
P025 ●



VIETATO L'USO DI
QUESTO DISPOSITIVO
VICINO A FONTI
D'ACQUA
P026 ●



VIETATO L'USO DI
QUESTO ASCENSORE
ALLE PERSONE
P027 ●



VIETATO
INDOSSARE
I GUANTI
P028 ●



VIETATO
FOTOGRAFARE
P029 ●



VIETATO
ANNODARE
LA CORDA
P030 ●



VIETATO ALTERARE
LO STATO DELL'
INTERRUTTORE
P031 ●



VIETATO USARE IL
DISCO PER LUSCIARE
LE SUPERFICI
P032 ●



VIETATO USARE
IL DISCO CON
ACQUA O
A UMIDO
P033 ●



VIETATO USARE
IL DISCO CON
ATTREZZATURE
MANUALI
P034 ●



VIETATO
INDOSSARE
SCARPE CON
SUOLE CHIODATE
P035 ●



VIETATO
L'ACCESSO
AI BAMBINI
P036 ●



VIETATO USCIRE
DALLA PISTA
P037 ●



VIETATO
DONDOLARSI
P038 ●



VIETATO ESEGUIRE
LAVORI A CALDO
P039 ●



VIETATO UTILIZZARE
FUOCHI D'ARTIFICIO
P040 ●



VIETATO
APPOGGIARSI
P041 ●



VIETATO L'ACCESSO
ALLE DONNE
IN STATO DI
GRAVIDANZA
P042 ●



VIETATO L'ACCESSO
ALLE PERSONE IN
STATO DI EBREZZA/
UBRIACHEZZA
P043 ●



VIETATO UTILIZZARE
"SMART GLASSES"/
OCCHIALI INTERATTIVI
P044 ●



VIETATO
ACCENDERE
FALÒ
P045 ●



VIETATO
SPORGERSI FUORI
DAL TOBOGA
P046 ●



VIETATO URTARE/
SPERNARE
GLI ALTRI TOBOGA
P047 ●



VIETATO
CORRERE
P048 ●



VIETATO
NUOTARE
P049 ●



VIETATO LO
SNORKELLING
P050 ●



VIETATO FARE
IMMERSIONI
SUBACQUE
P051 ●



VIETATO
TUFFARSI
P052 ●



VIETATO
ANDARE
IN BARCA
P053 ●



VIETATO FARE
WINDSURF
P054 ●



VIETATO L'USO
DI NATANTE
NON A MOTORE
P055 ●



VIETATO L'USO
DI IMBARCAZIONE
A MOTORE.
P056 ●



VIETATO L'USO
DI IMBARCAZIONI
DA DIPORTO
PERSONALI
P057 ●



VIETATO SPORT
ACQUATICO
DA TRAINO
P058 ●



VIETATO
L'USO
DEL SURF
P059 ●



VIETATO USARE
SCARPE INDOSSATE
ALL'ESTERNO
P060 ●



VIETATO
SALTARE
IN ACQUA
P061 ●



VIETATO SPINGERE
LE PERSONE
IN ACQUA.
P062 ●



VIETATO
IL BODY
BOARDING
P063 ●



VIETATA LA
NAVIGAZIONE
TRA LE BANDIERINE
ROSSE E GIALLE
P064 ●



VIETATO
PRATICARE IL
KITE SURFING
P065 ●



VIETATO IL
PARAPENDIO
P066 ●



VIETATO L'USO
DEL CARRO VELA.
P067 ●



VIETATA L'ESPOSIZIONE
ALLA LUCE SOLARE
O SUPERFICI CALDE
P068 ●



VIETATI INTERVENTI
DA PERSONALE
NON AUTORIZZATO
P069 ●



VIETATO METTERE
LE DITE ALL'INTERNO
DELLA BOCCHETTA
DELL'IDROMASSAGGIO
P070 ●



VIETATO
SCAVALCARE
LA RECINZIONE
P071 ●



VIETATO
SALTARE GIÙ
P072 ●



VIETATO CHIUDERE
IL COPERCHIO
QUANDO I FORNELLI
SONO ACCESI
P073 ●



VIETATO
INSTALLARE
SEGGIOLINI
DA BAMBINI
P074 ●



VIETATO RIMUOVERE
I DISPOSITIVI
DI PROTEZIONE
P075 ●



VIETATO
L'ACCESSO
P076 ●



VIETATO FERMARSI
NEL RAGGIO
D'AZIONE
DELLA GRU
P077 ●



VIETATO RIPARARE
E/O LUBRIFICARE
ORGANI IN MOTO
P078 ●



VIETATO
VERSARE LIQUIDI
INQUINANTI
NEGLI SCARICHI
P079 ●



VIETATO FERMARSI/
PASSARE
NEL RAGGIO
DELL'ESCAVATORE
P080 ●



VIETATO
TRASPORTARE
E SOLLEVARE
PERSONE
P081 ●



VIETATO
TRASPORTARE
PERSONE SUI
CARRELLI ELEVATORI
P082 ●



VIETATO SALIRE
SULLE FORCHE
DEI CARRELLI
ELEVATORI
P083 ●



VIETATO SOSTARE/
PASSARE SOTTO
LE FORCHE DEI
CARRELLI ELEVATORI
P084 ●



VIETATO
ALLE BICICLETTE
P085 ●



VIETATO ENTRARE
CON BOMBOLE
METALLICHE
P086 ●



VIETATO
SALIRE SUI
TRANSPALLETS
P087 ●



VIETATO TENERE
IL MOTORE
ACCESSO
P088 ●



VIETATO
PASSARE SOTTO PONTEGGI
O CARICHI
SOSPESI
P089 ●



CARTELLI DI DIVIETO

DIMENSIONI DEI CARTELLI DI DIVIETO



SIGLA FORMATO	DIMENSIONI (b x h)	SPESSORE ALLUMINIO	DISTANZA DI LETTURA	PREZZO ALLUMINIO PIANO	PREZZO PELLICOLA ADESIVA
K	115 x 115 mm	0,5 mm	4 metri	€ 5,40	€ 2,80
W	166 x 166 mm	0,5 mm	6 metri	€ 8,20	-
X	270 x 270 mm	0,5 mm	10 metri	€ 12,20	-
Y	435 x 435 mm	0,7 mm	16 metri	€ 40,40	-
Z	615 x 615 mm	1 mm	23 metri	€ 86,20	-

MATERIALI A RICHIESTA

Segnaletica standard fornita in alluminio piano. Per altri materiali, indicare la sigla P, R o S dopo il codice + lettera formato (esempio E1300**K**S):

sigla P PVC rigido (dielettrico) spessore 1 mm. Minimo ordinabile 1 pezzo.

sigla R Rifrangente su supporto di alluminio. Minimo ordinabile 1 pezzo.

sigla S Pellicola autoadesiva (solo formato K). Minimo ordinabile 5 pezzi/multipli.



CODICE DEL CARTELLO

FORMATI DISPONIBILI

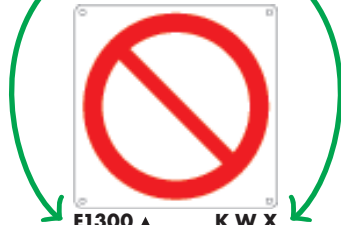

E1300 ▲

K W X



E1301 ▲

K W X Y



E1302 ▲

K W X



E1303 ▲

K W X



E1304 ▲

K W X Y



E1305 ▲

K W X



E1306 ▲

K W X



E1307 ▲

K W X



1308

K X Y Z



E1310 ▲

K X Y



1311

K W X Y Z



1312 ■*

K W X Y Z



1314 ■

K W X Y Z



E1315 ▲

K W X



1318

K X Y



1319

K X Y



E1321 ▲

K W X



1322

X Y

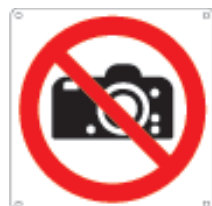

E1323 ▲

X Y



E1325 ▲

K W X



1326 ■ K W X Y



1327 ■ K W X Y



E1328 ▲ K W X



E1329 ▲ K W



E1330 ▲ K W



1334 X Y



E1335 ▲ K W X



E1336 K W X Z



1337 W X



E1338 ▲ K W X Y



E1339 ▲ K W X



E1340 ▲ K W X



E1341 ▲ K W X



1342 X



E1343 ▲ K W X



E1344 ▲ X



E1345 ▲ K W X



E1346 ▲ K W X



E1347 ▲ K W X



E1348 ▲ K W X



E1349 ▲ K W X



E13480 ▲ X



E13481 ▲ X



E13482 ▲ X



E13491 ▲ K W X



E13492 ▲ K W X



E13493 ▲ K W X



E13494 ▲ K W X



E13495 ▲ K



E13496 ▲ K



E13497 ▲ K



E13498 ▲ K X



ELEVATA RESISTENZA E DURATA DEI MATERIALI (CARATTERISTICHE A PAGINA 24).

■ Simboli contenuti nella **Norma UNI 7544**

* Simboli contenuti nel **D. Lgs. 81 del 09/04/08 Titolo V**

▲ Simboli contenuti nella **Norma ISO 7010**



CARTELLI DI DIVIETO

DIMENSIONI DEI CARTELLI DI DIVIETO



K - 350 x 125
H - 765 x 270
W - 1400 x 435
Z - 1845 x 615



X - 333 x 500
Y - 500 x 700

SIGLA FORMATO	DIMENSIONI (b x h)	SPESSORE ALLUMINIO	DISTANZA DI LETTURA	PREZZO ALLUMINIO PIANO	PREZZO PELLICOLA ADESIVA
K	350 x 125 mm	0,5 mm	4 metri	€ 7,30	€ 5,30
X	333 x 500 mm	0,7 mm	10 metri	€ 22,60	-
H	765 x 270 mm	0,7 mm	10 metri	€ 40,40	-
Y	500 x 700 mm	1 mm	16 metri	€ 68,00	-
W	1400 x 435 mm	0,7 mm	16 metri	€ 94,60	-
Z	1845 x 615 mm	1 mm	23 metri	€ 212,20	-

MATERIALI A RICHIESTA

Segnaletica standard fornita in alluminio piano. Per altri materiali, indicare la sigla P, R o S dopo il codice + lettera formato (esempio E1853XR):

sigla P PVC rigido (dielettrico) spessore 1 mm. Minimo ordinabile 1 pezzo.

sigla R Rifrangente su supporto di alluminio. Minimo ordinabile 1 pezzo.

sigla S Pellicola autoadesiva (solo formato K). Minimo ordinabile 5 pezzi/multipli.

i I CARTELLI DELLA SERIE 18.. POSSONO ESSERE REALIZZATI CON SCRITTE DIVERSE. MAGGIORI INFORMAZIONI A PAGINA 20.

⚡ ELEVATA RESISTENZA E DURATA DEI MATERIALI. VEDI CARATTERISTICHE A PAGINA 24.





E18063 K X



E18069 K



E18071 K



E1801 K X H Y W Z



E1802 K X Y



E1803 K X



E1804 K



E1869 K X



E1880 K X H



E18023 K



E18035 H Y



E18083 X



E18088 K



E18089 K



E18090 K



E18091 K X



E18092 Y



E180101 X



E180102 X



E180103 X



E180104 X



E180105 K



E180106 X



18018 K X



E1846 K X Y



E1871 K



E1806 K X



CARTELLI DI DIVIETO

DIMENSIONI DEI CARTELLI DI DIVIETO



K - 350 x 125
H - 765 x 270
W - 1400 x 435
Z - 1845 x 615



X - 333 x 500
Y - 500 x 700

SIGLA FORMATO	DIMENSIONI (b x h)	SPESSORE ALLUMINIO	DISTANZA DI LETTURA	PREZZO ALLUMINIO PIANO	PREZZO PELLICOLA ADESIVA
K	350 x 125 mm	0,5 mm	4 metri	€ 7,30	€ 5,30
X	333 x 500 mm	0,7 mm	10 metri	€ 22,60	-
H	765 x 270 mm	0,7 mm	10 metri	€ 40,40	-
Y	500 x 700 mm	1 mm	16 metri	€ 68,00	-
W	1400 x 435 mm	0,7 mm	16 metri	€ 94,60	-
Z	1845 x 615 mm	1 mm	23 metri	€ 212,20	-

MATERIALI A RICHIESTA

Segnaletica standard fornita in alluminio piano. Per altri materiali, indicare la sigla P, R o S dopo il codice + lettera formato (esempio E1816XR):

sigla P PVC rigido (dielettrico) spessore 1 mm. Minimo ordinabile 1 pezzo.

sigla R Rifrangente su supporto di alluminio. Minimo ordinabile 1 pezzo.

sigla S Pellicola autoadesiva (solo formato K). Minimo ordinabile 5 pezzi/multipli.

i I CARTELLI DELLA SERIE 18.. POSSONO ESSERE REALIZZATI CON SCRITTE DIVERSE. MAGGIORI INFORMAZIONI A PAGINA 20.

⚡ ELEVATA RESISTENZA E DURATA DEI MATERIALI. VEDI CARATTERISTICHE A PAGINA 24.

CODICE DEL CARTELLLO

FORMATI DISPONIBILI



E1816



K X



E1817



K X



E1818



K X



E1821



K X



E1851



K X



E1852



K X



E1857



K X



E1858



X



E1872



X



E1878



K X



E1885



X



E1889



X



E18014



Y



E18044



K X



E1822



K W X H Y



E1867



K X



E1874



K X H



E1892



K X





CARTELLI DI DIVIETO

DIMENSIONI DEI CARTELLI DI DIVIETO



K - 350 x 125
H - 765 x 270
W - 1400 x 435
Z - 1845 x 615



X - 333 x 500
Y - 500 x 700

SIGLA FORMATO	DIMENSIONI (b x h)	SPESSORE ALLUMINIO	DISTANZA DI LETTURA	PREZZO ALLUMINIO PIANO	PREZZO PELLICOLA ADESIVA
K	350 x 125 mm	0,5 mm	4 metri	€ 7,30	€ 5,30
X	333 x 500 mm	0,7 mm	10 metri	€ 22,60	-
H	765 x 270 mm	0,7 mm	10 metri	€ 40,40	-
Y	500 x 700 mm	1 mm	16 metri	€ 68,00	-
W	1400 x 435 mm	0,7 mm	16 metri	€ 94,60	-
Z	1845 x 615 mm	1 mm	23 metri	€ 212,20	-

MATERIALI A RICHIESTA

Segnaletica standard fornita in alluminio piano. Per altri materiali, indicare la sigla P, R o S dopo il codice + lettera formato (esempio E1884YP):

sigla P PVC rigido (dielettrico) spessore 1 mm. Minimo ordinabile 1 pezzo.

sigla R Rifrangente su supporto di alluminio. Minimo ordinabile 1 pezzo.

sigla S Pellicola autoadesiva (solo formato K). Minimo ordinabile 5 pezzi/multipli.

i I CARTELLI DELLA SERIE 18.. POSSONO ESSERE REALIZZATI CON SCRITTE DIVERSE. MAGGIORI INFORMAZIONI A PAGINA 20.

⚡ ELEVATA RESISTENZA E DURATA DEI MATERIALI. VEDI CARATTERISTICHE A PAGINA 24.

CODICE DEL CARTELLO

FORMATI DISPONIBILI



1884



Y



1894



K X Y



1898



K X Y



18039



X



18049



X



18050



K



18051



K



18055



K X Y



18056



K X Y



18062



K X



18066



K X



18079



K



18080



X



18081



X



18093



K



18121



K



1827



K X



1828



K X Y





CARTELLI DI DIVIETO

DIMENSIONI DEI CARTELLI DI DIVIETO



K - 350 x 125
H - 765 x 270
W - 1400 x 435
Z - 1845 x 615



X - 333 x 500
Y - 500 x 700

SIGLA FORMATO	DIMENSIONI (b x h)	SPESSORE ALLUMINIO	DISTANZA DI LETTURA	PREZZO ALLUMINIO PIANO	PREZZO PELLICOLA ADESIVA
K	350 x 125 mm	0,5 mm	4 metri	€ 7,30	€ 5,30
X	333 x 500 mm	0,7 mm	10 metri	€ 22,60	-
H	765 x 270 mm	0,7 mm	10 metri	€ 40,40	-
Y	500 x 700 mm	1 mm	16 metri	€ 68,00	-
W	1400 x 435 mm	0,7 mm	16 metri	€ 94,60	-
Z	1845 x 615 mm	1 mm	23 metri	€ 212,20	-

MATERIALI A RICHIESTA

Segnaletica standard fornita in alluminio piano. Per altri materiali, indicare la sigla P, R o S dopo il codice + lettera formato (esempio E1839K5):

sigla P PVC rigido (dielettrico) spessore 1 mm. Minimo ordinabile 1 pezzo.

sigla R Rifrangente su supporto di alluminio. Minimo ordinabile 1 pezzo.

sigla S Pellicola autoadesiva (solo formato K). Minimo ordinabile 5 pezzi/multipli.

i I CARTELLI DELLA SERIE 18.. POSSONO ESSERE REALIZZATI CON SCRITTE DIVERSE. MAGGIORI INFORMAZIONI A PAGINA 20.

⚡ ELEVATA RESISTENZA E DURATA DEI MATERIALI. VEDI CARATTERISTICHE A PAGINA 24.





E18024 K

**NON USARE
IN CASI
DI EMERGENZA**



E18348 K X

**VIETATO
CALPESTARE
O SOSTARE
IN QUESTA ZONA**



E18349 K X

**VIETATO L'USO
DI QUESTA
IMPALCATURA
INCOMPLETA**



E18491 K X

**VIETATO USARE
IL DISCO CON
ATTREZZATURE
MANUALI**



E18492 K X

**VIETATO L'USO DI
QUESTO DISPOSITIVO
VICINO A FONTI
D'ACQUA**



E1836 K X Y

**NON EFFETTUARE
MANOVRE
macchina in
manutenzione**



E1838 K X

**NON EFFETTUARE
MANOVRE
macchina in riparazione**



E1840 K X

**NON EFFETTUARE
MANOVRE
lavori in corso**



E1861 K

**VIETATO INTERVENIRE
SU APPARECCHIATURE
O LINEE ELETTRICHE
AL PERSONALE
NON AUTORIZZATO**



E1868 K

**NON EFFETTUARE
MANOVRE
si lavora sulla linea**



E18016 X

**NON EFFETTUARE
MANOVRE
a macchina in moto**



E18493 K

**VIETATO ALTERARE
LO STATO
DELL'INTERRUTTORE**



E18494 K X

**VIETATO USARE
IL DISCO CON
ACQUA O A UMIDO**



E1883 K X

**NON LAVORATE
CON GETTI D'ACQUA
in questa zona**



E18019 K X

**NON INDIRIZZARE
GETTI D'ACQUA
SU MOTORI E
LINEE ELETTRICHE**



18500 K

**DIVIETO DI
BALNEAZIONE**



E18496 K

**VIETATO
L'ACCESSO
AI BAMBINI**



E18497 K

**VIETATO INDOSSARE
SCARPE CON SUOLE
CHIODATE**



E18498 K X

**VIETATO
EFFETTUARE
LAVORI A CALDO**

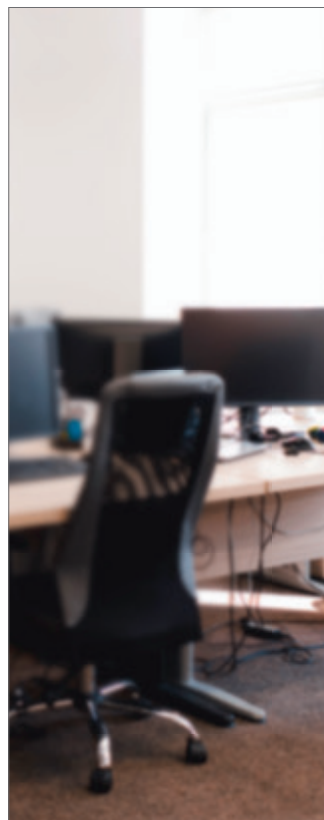



CARTELLI DI DIVIETO

DIMENSIONI DEI CARTELLI DI DIVIETO



CODICE	DIMENSIONI (b x h)	DISTANZA DI LETTURA	SPESSORE ALLUMINIO	PREZZO ALLUMINIO PIANO	PREZZO PELLICOLA ADESIVA
E61.....K	115 x 140 mm	4 metri	0,7 mm	€ 9,40	€ 5,40
E62.....K	115 x 160 mm	4 metri	0,7 mm	€ 9,50	€ 5,60
E63.....K	115 x 178 mm	4 metri	0,7 mm	€ 9,90	€ 5,80
E61.....W	166 x 210 mm	6 metri	0,7 mm	€ 13,40	-
E62.....W	166 x 233 mm	6 metri	0,7 mm	€ 13,60	-
E63.....W	166 x 262 mm	6 metri	0,7 mm	€ 14,40	-
E61.....X	270 x 330 mm	10 metri	0,7 mm	€ 20,40	-
E62.....X	270 x 370 mm	10 metri	0,7 mm	€ 21,20	-
E63.....X	270 x 430 mm	10 metri	0,7 mm	€ 24,60	-
E61.....Y	435 x 530 mm	16 metri	0,7 mm	€ 49,00	-
E62.....Y	435 x 603 mm	16 metri	0,7 mm	€ 52,20	-
E63.....Y	435 x 678 mm	16 metri	0,7 mm	€ 59,60	-

MATERIALI A RICHIESTA

Segnaletica standard fornita in alluminio piano. Per altri materiali, indicare la sigla P, R o S dopo il codice + lettera formato (esempio E610101K5):

- sigla P** PVC rigido (dielettrico) spessore 1 mm. Minimo ordinabile 1 pezzo.
- sigla R** Rifrangente su supporto di alluminio. Minimo ordinabile 1 pezzo.
- sigla S** Pellicola autoadesiva (solo formato K). Minimo ordinabile 5 pezzi/multipli.



CARTELLI SUL DIVIETO DI ABBANDONO MOZZICONI PRESENTI ALLE PAGINE 113,161 E 166.

i I CARTELLI DELLE SERIE 61..., 62... E 63... POSSONO ESSERE REALIZZATI CON SCRITTE DIVERSE. MAGGIORI INFORMAZIONI A PAGINA 20.

CODICE DEL CARTELLO **FORMATI DISPONIBILI**

E610101 K W X Y **E610102** X
E610301 K W X **E610401** X Y **E610601** X **611202** K W X Y
611203 K W X Y **E611601** K X **E612301** K X **E620101** X **E620102** X **E622001** K
E620301 K W X **E620403** X Y **E620501** K W X Y **E620601** K W X **E620602** K W X Y **621201** K W X Y

i I CARTELLI DELLE SERIE 61..., 62... E 63... POSSONO ESSERE REALIZZATI CON SCRITTE DIVERSE. MAGGIORI INFORMAZIONI A PAGINA 20.



**VIETATO L'ACCESSO AI
NON ADDETTI AI LAVORI**
621202 K X Y



**VIETATO L'INGRESSO
AI NON ADDETTI**
621203 K W X Y



**È SEVERAMENTE VIETATO
OLTREPASSARE QUESTO LIMITE**
621205 X



**VIETATO OPERARE
SU ORGANI IN MOTO**
621401 K W X Y



**NON TRASPORTARE
PERSONE SUI CARRELLI**
621901 K X Y



**VIETATO IL TRANSITO
AI CARRELLI**
E622101 X Y



**VIETATO IL TRANSITO
ALLE BICICLETTE**
622201 X



**VIETATO SALIRE
SULLE FORCHE**
622601 K



**VIETATO USARE I CARRELLI
IN MODO IMPROPRIO**
623401 X



**NON SALIRE O SCENDERE
ALL'ESTERNO DEI PONTEGGI**
624001 X



**NON GETTARE
MATERIALI DAI PONTEGGI**
624101 X



**VIETATO L'USO DI
TELEFONI CELLULARI**
E623801 K W X Y



**VIETATO CALPESTARE
I LUCERNARI**
E624801 K



**VIETATO MANOMETTERE
LE ATTREZZATURE E
GLI IMPIANTI ANTINCENDIO**
E630001 K



**VIETATO SALIRE
SULLA MACCHINA
IN MOVIMENTO**
E630002 W X



**VIETATO
CAMMINARE
SULLE RULLIERE**
E630003 X



**VIETATO
ARRAMPICARSI
SULLA MACCHINA**
E630004 X



**VIETATO FUMARE
NO SMOKING
DEFENSE DE FUMER
RAUCHEN VERBOTEN**
E630102 K X



**VIETATO L'USO
DI SIGARETTE
ELETTRONICHE**
630103 K X



VIETATO FUMARE
ALCANTARA NELLE AREE DI PORTINERIA DI QUESTO EDIFICIO
E630105 W X



**VIETATO FUMARE
RAUCHEN VERBOTEN**
E630106 W



VIETATO FUMARE
ALCANTARA NELLE AREE DI PORTINERIA DI QUESTA
STRUTTURA OSPEDALIERA
E630107 W X



VIETATO FUMARE
ALCANTARA NELLE AREE DI PORTINERIA DI QUESTO EDIFICIO
E630108 W X



VIETATO FUMARE
ALCANTARA NELLE AREE DI PORTINERIA DI QUESTA
STRUTTURA SCOLASTICA
E630109 W X



VIETATO FUMARE
ALCANTARA NELLE AREE DI PORTINERIA DI QUESTA
STRUTTURA UNIVERSITARIA
E630110 W X



VIETATO FUMARE
ALCANTARA NELLE AREE DI PORTINERIA DI QUESTO EDIFICIO
E630111 W X



**MONTACARICHI
PER SOLE COSE
NON TRASPORTARE
PERSONE**
E632002 W X



**È VIETATO USARE
L'ASCENSORE
ALLE PERSONE
NON AUTORIZZATE**
E632005 W



**È VIETATO
USARE L'ASCENSORE
PER ABBANDONARE I LOCALI
IN CASO DI EMERGENZA**
E632003 W X



**NON USARE
IN CASO
DI INCENDIO**
E632004 W X

ELEVATA RESISTENZA E DURATA DEI MATERIALI. VEDI CARATTERISTICHE A PAGINA 24.



CARTELLI DI DIVIETO

DIMENSIONI DEI CARTELLI DI DIVIETO



MATERIALI A RICHIESTA

Segnaletica standard fornita in alluminio piano. Per altri materiali, indicare la sigla P, R o S dopo il codice + lettera formato (esempio E630501XR):

- sigla P** PVC rigido (dielettrico) spessore 1 mm. Minimo ordinabile 1 pezzo.
- sigla R** Rifrangente su supporto di alluminio. Minimo ordinabile 1 pezzo.
- sigla S** Pellicola autoadesiva (solo formato K). Minimo ordinabile 5 pezzi/multipli.

CODICE	DIMENSIONI (b x h)	DISTANZA DI LETTURA	SPESSORE ALLUMINIO	PREZZO ALLUMINIO PIANO	PREZZO PELLICOLA ADESIVA
E61.....K	115 x 140 mm	4 metri	0,7 mm	€ 9,40	€ 5,40
E62.....K	115 x 160 mm	4 metri	0,7 mm	€ 9,50	€ 5,60
E63.....K	115 x 178 mm	4 metri	0,7 mm	€ 9,90	€ 5,80
E61.....W	166 x 210 mm	6 metri	0,7 mm	€ 13,40	-
E62.....W	166 x 233 mm	6 metri	0,7 mm	€ 13,60	-
E63.....W	166 x 262 mm	6 metri	0,7 mm	€ 14,40	-
E61.....X	270 x 330 mm	10 metri	0,7 mm	€ 20,40	-
E62.....X	270 x 370 mm	10 metri	0,7 mm	€ 21,20	-
E63.....X	270 x 430 mm	10 metri	0,7 mm	€ 24,60	-
E61.....Y	435 x 530 mm	16 metri	0,7 mm	€ 49,00	-
E62.....Y	435 x 603 mm	16 metri	0,7 mm	€ 52,20	-
E63.....Y	435 x 678 mm	16 metri	0,7 mm	€ 59,60	-



i I CARTELLI DELLE SERIE 61.., 62.. E 63.. POSSONO ESSERE REALIZZATI CON SCRITTE DIVERSE (VEDI PAGINA 20).

CODICE DEL CARTELLO FORMATI DISPONIBILI

VIETATO USARE APPARECCHI AD INCANDESCENZA SENZA PROTEZIONE (E630501 X)

NON USARE ACQUA PER SPEGNERE INCENDI SU PARTI ELETTRICHE (E630601 K W X)

VIETATO TRASPORTARE E SOLLEVARE PERSONE (630801 K X Y)

DIVIETO DI VENDITA DI BEVANDE ALCOLICHE AI MINORI (631001 W X)

NON RIMUOVERE LE PROTEZIONI E I DISPOSITIVI DI SICUREZZA (631101 K W X Y)

NON RIMUOVERE I DISPOSITIVI DI SICUREZZA A MACCHINA IN MOTO (631102 K W X Y)

AREA CON RUMORE SUPERIORE A 85 dB(A) VIETATO L'INGRESSO AI NON AUTORIZZATI (631201 X Y)

VIETATO L'INGRESSO a tutte le persone non autorizzate (631202 K W X Y)

AREA CON RUMORE SUPERIORE A 85 dB(A) VIETATO ACCEDERE SENZA PROTEZIONI ACUSTICHE (631204 X Y)

È VIETATO RIPARARE, OLIARE, REGISTRARE, PULIRE ORGANI IN MOTO (631401 K X Y)

VIETATO PULIRE E LUBRIFICARE ORGANI IN MOTO (631402 K W X Y)

VIETATO RIPARARE E/O REGISTRARE ORGANI IN MOTO (631403 K W X Y)

È VIETATO OPERARE SU ORGANI IN MOTO (631404 K X Y)

VIETATO L'USO ALLE PERSONE NON AUTORIZZATE (E631501 K X)

È VIETATO ESEGUIRE LAVORI PRIMA CHE SIA STATA TOLTA TENSIONE (E631504 K W X)

È VIETATO INTERVENIRE CON LE MANI A MACCHINA IN MOTO (E631505 K)

NON APRIRE L'apertura del quadro è consentita solo agli elettricisti (E631506 K W)

LAVORI IN CORSO NON EFFETTUARE MANOVRE (E631601 K W X Y)



LE PRIME DUE CIFRE DEL CODICE IDENTIFICANO IL FORMATO

CODICE	FORMATO	MATERIALE	SPESSORE	PREZZO
29...	333 x 500 mm	Alluminio	0,7 mm	€ 23,60
35...	300 x 200 mm	Alluminio	0,5 mm	€ 10,00
35...S	300 x 200 mm	Pellicola autoadesiva	-	€ 8,00
45...	500 x 700 mm	Alluminio	1 mm	€ 71,40

I CARTELLI DELLE SERIE 29... 35... E 45... POSSONO ESSERE REALIZZATI CON SCRITTE DIVERSE. MAGGIORI INFORMAZIONI A PAGINA 20.

MATERIALI

Tutti i cartelli sono disponibili in alluminio nei formati indicati in tabella. I codici con la sigla S sono forniti in pellicola autoadesiva. A richiesta fornibili in altri materiali (richiedi un preventivo).

ELEVATA RESISTENZA E DURATA DEI MATERIALI. VEDI LE CARATTERISTICHE A PAGINA 24.





CARTELLI MULTISIMBOLO

LE PRIME DUE CIFRE DEL CODICE IDENTIFICANO IL FORMATO

CODICE	FORMATO	MATERIALE	SPESSORE	PREZZO
E29...	500 x 333 mm	Alluminio	0,7 mm	€ 23,60
35...	300 x 200 mm	Alluminio	0,5 mm	€ 10,00
35...S	300 x 200 mm	Pellicola autoadesiva	-	€ 8,00

! ALTRE GRAFICHE DISPONIBILI A RICHIESTA CON I CODICI SXD18X E SXD31 (VEDI PAGINA 21).



E2912



E2913



E2916



E2925



E2926



E2928

E3528



E2929



E2930



E2931

E3531

E3531 S



E2932



2935

3535



E2937



E2938



E2939
discesa

E2941
salita

E3536
discesa

E3538
salita



E2940
discesa

E2945
salita

E3537
discesa

E3539
salita



E2942

E3542



E2947



E2948



E2951

E3551



E2952



E2954



E2955



E2962

E3562

E3562 S



E2963

E3563

E3563 S



E2966

E3566



E2967



E3570



E3520



E3521



E3526



E3527



E3529



E3530



E3543

E3543S



CARTELLI MULTISIMBOLO

LE PRIME DUE CIFRE DEL CODICE IDENTIFICANO IL FORMATO

CODICE	FORMATO	MATERIALE	SPESSORE	PREZZO
E29...	500 x 333 mm	Alluminio	0,7 mm	€ 23,60
35...	300 x 200 mm	Alluminio	0,5 mm	€ 10,00
35...S	300 x 200 mm	Pellicola autoadesiva	-	€ 8,00

! ALTRE GRAFICHE DISPONIBILI A RICHIESTA CON I CODICI SXD18X E SXD31 (VEDI PAGINA 21).



E3541



E3548



E3549



E3550



E35100



E3553



E3557



E3567



E3569



E35320

35320



E29340

35340



E29440

E35440



E29443



E29446



E29691

E35691



E29692

E35692

ANTINCENDIO: SIGNIFICATO DEI SIMBOLI



ESINTORE
ANTINCENDIO
F001 ●



LANCIA
ANTINCENDIO
NASPO
F002 ●



SCALA
ANTINCENDIO
F003 ●



ATTREZZATURE
ANTINCENDIO
F004 ●



PULSANTE
ALLARME
ANTINCENDIO
F005 ●



TELEFONO
DI EMERGENZA
ANTINCENDIO
F006 ●



PORTA
TAGLIAFUOCO/
ANTINCENDIO
F007 ●



BATTERIA
FISSA ESTINTORE
ANTINCENDIO
F008 ●



ESINTORE
ANTINCENDIO
CARRELLATO
F009 ●



GRUPPO
PORTATILE
ANTINCENDIO
A SCHIUMA
F010 ●



SISTEMA D'ESTINZIONE
INCENDIO AD ACQUA
NEBULIZZATA
F011 ●



INSTALLAZIONE
FISSA D'ESTINZIONE
INCENDI
F012 ●



ESTINTORE
ANTINCENDIO
FISSO
F013 ●



STAZIONE
DI RILASCIO
A DISTANZA
F014 ●



SPINGARDA
ANTINCENDIO
F015 ●



COPERTA
ANTIFIAMMA
F016 ●



ASCENSORE
ANTINCENDIO
F017 ●



SPIA LUMINOSA
ALLARME
ANTINCENDIO
F018 ●



MANICHETTA
ANTINCENDIO
SCOLLEGATA
F019 ●



IDRANTE
ANTINCENDIO



SPRINKLER
ANTINCENDIO



IDRANTE
SOPRASUOLO



INTERRUTTORE
ELETTRICO
ANTINCENDIO



PORTA
TAGLIAFUOCO



VALVOLA DI
INTERCETTAZIONE



RILEVATORE
DI FUMO



CARTELLI ANTINCENDIO

DIMENSIONI DEI CARTELLI ANTINCENDIO



K - 120 x 120
W - 160 x 160
X - 250 x 250
Y - 400 x 400
Z - 530 x 530

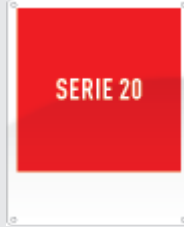

K - 120 x 145
W - 160 x 210
X - 250 x 310
Y - 400 x 500
Z - 530 x 632

CODICE	DIMENSIONI (b x h)	DISTANZA DI LETTURA	SPESSORE ALLUMINIO	PREZZO ALLUMINIO PIANO	PREZZO PELLICOLA ADESIVA
E15...K	120 x 120 mm	4 metri	0,5 mm	€ 5,60	€ 3,30
E20...K	120 x 145 mm	4 metri	0,5 mm	€ 5,90	€ 5,30
E15...W	160 x 160 mm	6 metri	0,5 mm	€ 5,60	€ 4,90
E20...W	160 x 210 mm	6 metri	0,5 mm	€ 5,90	€ 5,90
E15...X	250 x 250 mm	10 metri	0,5 mm	€ 7,10	-
E20...X	250 x 310 mm	10 metri	0,5 mm	€ 8,00	-
E15...Y	400 x 400 mm	16 metri	0,7 mm	€ 24,60	-
E20...Y	400 x 500 mm	16 metri	0,7 mm	€ 32,00	-
E15...Z	530 x 530 mm	22 metri	0,7 mm	€ 53,20	-
E20...Z	530 x 632 mm	22 metri	0,7 mm	€ 62,80	-

MATERIALI A RICHIESTA

Segnaletica standard fornita in alluminio piano. Per altri materiali, indicare la sigla P, R o S dopo il codice + lettera formato (esempio E15106YR):

sigla P PVC rigido (dielettrico) spessore 1 mm. Minimo ordinabile 1 pezzo.

sigla R Rifrangente su supporto di alluminio. Minimo ordinabile 1 pezzo.

sigla S Pellicola autoadesiva (solo formato K). Minimo ordinabile 5 pezzi/multipli.

i **SIMBOLI NON A NORMA UNI EN ISO 7010. I CARTELLI CON QUESTI SIMBOLI SONO FORNIBILI A RICHIESTA.**



E15106 ■ KWXYZ



E15107▲ KWXYZ

■ Simboli contenuti nella **Norma UNI 7546**
▲ Simboli contenuti nella **Norma ISO 7010**



E15165▲ KWXYZ



E15111▲ K X



I5114 W X



E15115▲ KWXYZ



E15117▲ K W X Y



E15121▲ K W X



I5129■ W X Y Z



I5147 K X



E15167▲ K W X Y



E15168▲ X



E15500▲ X



E15501▲ X



E15502▲ X



E15503▲ X



E15504▲ X



E15505▲ X



E15506▲ X



E15507▲ K W X



E20117 KWXYZ



E20177 X Y



E20118 KWXYZ



E20121 K W X Y



E20124 W X



E20125 X



E20126 W X



E20150 K W X



E20140 W X Y Z



E20152 X Y



E20179 X



E20180 X



E20119 K X



20151 W X



E20157 K W X Y



E20160 K W X Y



E20161 W X



E20165 X Y



E20168 X



E20178 X



E20174 K W X Y



E20156 K W X



20170 X Y



20176 X Y



20182 X



20187 X



20127 K



20147 K W X



20148 X



20149 X



20172 X



20183 K W X



E20163 K W X Y



E20159 X



20155 K W X



20188 X



20164 X Y



E20184 K W X



E201390 K W X



E201391 W X



E201392 W X

CARTELLI ANTINCENDIO IN VERSIONE SCATOLATA A PAGINA 160.

EMERGENZA: SIGNIFICATO DEI SIMBOLI



USCITA DI EMERGENZA A SINISTRA
E001 ●



USCITA DI EMERGENZA A DESTRA
E002 ●



PRIMO SOCCORSO
E003 ●



TELEFONO DI EMERGENZA
E004 ●



FRECCIA A DESTRA/SINISTRA
E005 ●



FRECCIA DIAGONALE A DESTRA/SINISTRA
E006 ●

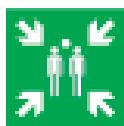

PUNTO DI RITROVO ED EVACUAZIONE
E007 ●



ROMPERE IN CASO DI EMERGENZA
E008 ●



DOTTORE
E009 ●



DEFIBRILLATORE ESTERNO DI EMERGENZA
E010 ●



LAVAOCCHI DI EMERGENZA
E011 ●



DOCCIA DI EMERGENZA
E012 ●



BARELLA DI EMERGENZA
E013 ●



SISTEMA DI RILEVAMENTO PRESENZA DEL SISTEMA DI RITENUTA PER BAMBINI E SUO ORIENTAMENTO (CPOD)
E014 ●



ACQUA POTABILE
E015 ●



FINESTRA DI EMERGENZA CON SCALA
E016 ●



FINESTRA DI RECUPERO E SALVATAGGIO
E017 ●



GIRARE LA MANIGLIA IN SENSO ANTIORARIO
E018 ●



GIRARE LA MANIGLIA IN SENSO ORARIO
E019 ●



PULSANTE PER ARRESTO DI EMERGENZA
E020 ●



RIFUGIO DI EMERGENZA/PROTEZIONE
E021 ●



PORTA CON APERTURA A SPINTA SUL LATO SINISTRO
E022 ●



PORTA CON APERTURA A SPINTA SUL LATO DESTRO
E023 ●



RIFUGIO TEMPORANEO DI EVACUAZIONE/ SPAZIO CALMO
E024 ●



MARTELLINO DI EMERGENZA
E025 ●



USCITA DI EMERGENZA A SINISTRA ADATTA A PERSONE CON DISABILITÀ
E026 ●



BORSA MEDICA DI EMERGENZA
E027 ●



OSSIGENO (MEDICALE) DI RIANIMAZIONE
E028 ●



AUTORESPIRATORE PER L'EVACUAZIONE D'URGENZA
E029 ●



USCITA DI EMERGENZA A DESTRA ADATTA A PERSONE CON DISABILITÀ
E030 ●



ALLARME GENERALE DI BORDO
E031 ●



PUNTO DI RACCOLTA A BORDO
E032 ●

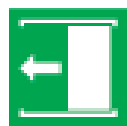

PORTA SCORREVOLE CON APERTURA A SINISTRA
E033 ●



PORTA SCORREVOLE CON APERTURA A DESTRA
E034 ●



COLTELLO PER ZATTERA DI SALVATAGGIO
E035 ●



SCIALUPPA DI SALVATAGGIO
E036 ●



BARCA DI SALVATAGGIO
E037 ●



ZATTERA DI SALVAGGIO
E038 ●



ZATTERA DI SALVATAGGIO
CON ALAGGIO DAVIT
E039 ●



SALVAGENTE
E040 ●



SALVAGENTE
CON CIMA
E041 ●



SALVAGENTE
CON BOETTA LUMINOSA
E042 ●



SALVAGENTE
CON CIMA
E BOETTA
LUMINOSA
E043 ●



GIUBBOTTO
SALVAGENTE
E044 ●



GIUBBOTTO
SALVAGENTE
PER BAMBINI
E045 ●



GIUBBOTTO
SALVAGENTE
PER NEONATI
E046 ●



SART
E047 ●



RAZZO DI
SEGNALAZIONE
E048 ●



RAZZO A
PARACADUTE
E049 ●



LANCIASAGOLE
E050 ●



REDIOTELEFONO
A DUE VIE
E051 ●



RADIOFARO
INDICATORE
DI POSIZIONE
DI EMERGENZA
E052 ●



BISCAGLINA
E053 ●



SCIVOLO DI
EVACUAZIONE
NAVE
E054 ●



CONDOTTO DI
EVACUAZIONE
NAVE
E055 ●



ABBIGLIAMENTO
DI SOPRAVVIVENZA
E056 ●



TIRARE
VERSO SINISTRA
PER APRIRE
E057 ●



TIRARE
VERSO DESTRA
PER APRIRE
E058 ●



SCALA DI
EVACUAZIONE
E059 ●

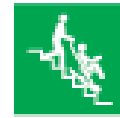

SEDIA DI
EVACUAZIONE
E060 ●



EQUIPAGGIAMENTO DI
SALVATAGGIO
E061 ●



AREA DI
EVACUAZIONE
TSUNAMI
E062 ●



EDIFICIO PER
L'EVACUAZIONE
TSUNAMI
E063 ●



ADDETTO
PRIMO
SOCCORSO
E064 ●



AREA SICURA
ESTERNA IN CASO
DI DISASTRO
NATURALE
E065 ●



LUOGO
SICURO



MASCHERA/
RESPIRATORE
DI EMERGENZA



CHIAVE DI
EMERGENZA



INTERRUTTORE
ELETRICO
DI EMERGENZA



EQUIPAGGIAMENTO
DI SALVATAGGIO



CARTELLI DI EMERGENZA

DIMENSIONI DEI CARTELLI DI EMERGENZA



K - 120 x 120
W - 160 x 160
X - 250 x 250
Y - 400 x 400
Z - 530 x 530
L - 800 x 800



K - 120 x 145
W - 160 x 210
X - 250 x 310
Y - 400 x 500
Z - 530 x 632

CODICE	DIMENSIONI (b x h)	DISTANZA DI LETTURA	SPESSORE ALLUMINIO	PREZZO ALLUMINIO PIANO	PREZZO PELLICOLA ADESIVA
E15...K	120 x 120 mm	4 metri	0,5 mm	€ 5,60	€ 3,30
E20...K	120 x 145 mm	4 metri	0,5 mm	€ 5,90	€ 5,30
E15...W	160 x 160 mm	6 metri	0,5 mm	€ 5,60	€ 4,90
E20...W	160 x 210 mm	6 metri	0,5 mm	€ 5,90	€ 5,90
E15...X	250 x 250 mm	10 metri	0,5 mm	€ 7,10	-
E20...X	250 x 310 mm	10 metri	0,5 mm	€ 8,00	-
E15...Y	400 x 400 mm	16 metri	0,7 mm	€ 24,60	-
E20...Y	400 x 500 mm	16 metri	0,7 mm	€ 32,00	-
E15...Z	530 x 530 mm	22 metri	0,7 mm	€ 53,20	-
E20...Z	530 x 632 mm	22 metri	0,7 mm	€ 62,80	-
E15...L	800 x 800 mm	35 metri	1 mm	€ 131,80	-

MATERIALI A RICHIESTA

Segnaletica standard fornita in alluminio piano. Per altri materiali, indicare la sigla P, R o S dopo il codice + lettera formato (esempio E15101WP):

sigla P PVC rigido (dielettrico) spessore 1 mm. Minimo ordinabile 1 pezzo.

sigla R Rifrangente su supporto di alluminio. Minimo ordinabile 1 pezzo.

sigla S Pellicola autoadesiva (solo formato K). Minimo ordinabile 5 pezzi/multipli.

CODICE DEL CARTELLO

FORMATI DISPONIBILI



E15101 ▲ K W X Y



E15102 ▲ K W X



E15103 ▲ K W X



E15104 ▲ K W X Y Z

ALTRE LINEE DI SEGNALETICA DI EMERGENZA ALLE PAGINE 94-112.



E15105 ▲ K W X Y Z



E15116 ▲ K W X



E15153 ▲ K W X Y Z L



E15154 ▲ K W X Y Z L



E15156 ▲ K W X



E15118 ▲ K W X



E15179 ▲ K W X Y



E15237 ▲ K



E15238 ▲ K



E15180 ▲ W X Y Z



15194 ■ W X



E15148 ▲ K W



E15112 ▲ K W X



E15142 ▲ X



E15119 ▲ K W X



E15120 ▲ K W X



E15235 ▲ K



E15236 ▲ K



E15122 ▲ K W X



E15123 ▲ K W X



E15221 ▲ K



E15231 ▲ K



E15232 ▲ K



E15233 ▲ K



E15158 ▲ K W X



E15176 ▲ K W



E15149 ▲ K W



E15159 ▲ KWXYZL



E15157 ▲ K X Y



PRONTO SOCCORSO
E20101 ▲ K X Y Z



INFERMERIA
E20102 ▲ K W X Y



CASSETTA DI MEDICAZIONE
E20113 K W X Y



CASSETTA DI PRONTO SOCCORSO
E20114 K W X Y



DOCCIA DI EMERGENZA
E20103 K W X Y



LAVAOCCHI DI EMERGENZA
E20104 K W X Y



TEL. N°
E20162 K W X Y



USCITA DI EMERGENZA
E20105 K W X Y Z



USCITA DI EMERGENZA
E20106 K W X Y Z



DAE
E20109 K W X



PERSONALE MEDICO
E20196 K X



BARELLA DI PRONTO SOCCORSO
E20154 K W X Y



BORSA PRIMO SOCCORSO PORTATILE
E20197 X



OSSIGENO PER RIANIMAZIONE
E20198 X



PUNTO DI RACCOLTA
E20153 W X Y Z



PUNTO DI RACCOLTA N.
E20171 Y



PUNTO DI RITROVO
E20173 W X Y



SEDIA DI EVACUAZIONE
E20193 X



LUOGO SICURO
20194 W X



SPAZIO CALMO
E20195 X



SCALA DI EVACUAZIONE
E20199 X



AUTOPROTETTORE AD ARIA COMPRESSA
E20158 X



MASCHERE
20115 W X



RESPIRATORI
20116 W X



KIT ANTISVERSAMENTO
20122 W X Y



PRONTO INTERVENTO PER ACIDO SOLFORICO BATTERIE
20123 K X Y



CHIAVE DI EMERGENZA
20132 K X



**Informazione elettrica gruppo elettrico
MANOVRARE SOLO IN CASO D'INCENDIO**
20166 X



PREMERE PER APERTURA PORTA
20142 W X



ACQUA POTABILE
E20108 K X Y



EQUIPAGGIAMENTO DI SALVATAGGIO
20500 X

! NELLA NORMA ISO 7010 LE FRECCE SUPPLEMENTARI E15104 ED E15105 SONO DA UTILIZZARSI ABBINATE AI SEGNALI USCITA DI EMERGENZA E15153, E15154, E20105 E E20106 PER DARE L'INFORMAZIONE SULLA DIREZIONE.



■ Simboli contenuti nella **Norma UNI 7546**
▲ Simboli contenuti nella **Norma ISO 7010**



CARTELLI DI EMERGENZA ISO 7010

DIMENSIONI DEI CARTELLI DI EMERGENZA

SERIE 715

K - 120 x 120
W - 160 x 160
X - 250 x 250

SERIE 720

K - 120 x 145
W - 160 x 210
X - 250 x 310

CODICE	DIMENSIONI (b x h)	DISTANZA DI LETTURA	SPESSORE ALLUMINIO	PREZZO ALLUMINIO PIANO	PREZZO PELLICOLA ADESIVA
E715.....K	220 x 120 mm	4 metri	0,5 mm	€ 6,20	€ 4,10
E720.....K	320 x 120 mm	4 metri	0,5 mm	€ 7,60	€ 5,60
E715.....W	300 x 160 mm	6 metri	0,5 mm	€ 7,60	€ 5,60
E720.....W	440 x 160 mm	6 metri	0,5 mm	€ 8,50	€ 6,60
E715.....X	480 x 250 mm	10 metri	0,7 mm	€ 15,60	€ 12,20
E720.....X	710 x 250 mm	10 metri	0,7 mm	€ 21,20	€ 17,40

MATERIALI A RICHIESTA

Segnaletica standard fornita in alluminio piano. Per altri materiali, indicare la sigla P, R o S dopo il codice + lettera formato (esempio E715101KS):

sigla P PVC rigido (dielettrico) spessore 1 mm. Minimo ordinabile 1 pezzo.

sigla R Rifrangente su supporto di alluminio. Minimo ordinabile 1 pezzo.

sigla S Pellicola autoadesiva (solo formato K). Minimo ordinabile 5 pezzi/multipli.



E715101

K W X



E715102

K W X



E715103

K W X

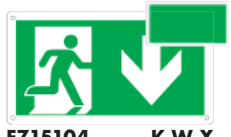

E715104

K W X

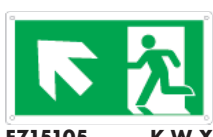

E715105

K W X



E715106

K W X



E715107

K W X



E715108

K W X

ALTRE LINEE
 DI SEGNALETICA
 DI EMERGENZA
 ALLE PAGINE 94-112.

BIFACCIALE SOSPESO
 COD. E720101SK

BIFACCIALE A BANDIERA
 COD. E715104BK

TUTTI I SEGNALI DI EVACUAZIONE SERIE E715 E SERIE E720 POSSONO ESSERE REALIZZATI NELLA VERSIONE A BANDIERA BIFACCIALE (B) NEI FORMATI K E W, E SOSPESA BIFACCIALE (S) NEI FORMATI K, W E X, AGGIUNDO PRIMA DELLA LETTERA FORMATO LA LETTERA B O S. LA VERSIONE A BANDIERA BIFACCIALE HA L'ATTACCO PREVISTO A SINISTRA.



E720101

K W X



E720102

K W X



E720103

K W X



E720104

K W X



E720105

K W X



E720106

K W X



E720107

K W X



E720108

K W X



E720201

K W X



E720202

K W X



E720203

K W X



E720204

K W X

Il retro vuoto (colore verde, senza pittogrammi e scritte) si riferisce solo alle versioni bifacciale a bandiera e bifacciale sospesa.



E720205 K W X



E720206 K W X



E720207 K W X



E720208 K W X



E720301 K W X

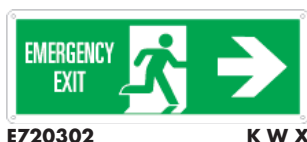

E720302 K W X



E720303 K W X



E720304 K W X



E720305 K W X



E720306 K W X



E720307 K W X



E720308 K W X

Cartelli di emergenza in alluminio D. Lgs. 81/08

DIMENSIONI DEI CARTELLI DI EMERGENZA



SERIE 15



SERIE 16

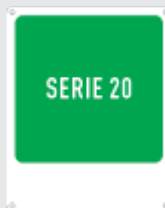

SERIE 20

CODICE	DIMENSIONI (b x h)	DISTANZA DI LETTURA	SPESSORE ALLUMINIO	PREZZO ALLUMINIO PIANO	PREZZO PELLICOLA ADESIVA
15...K	120 x 120 mm	4 metri	0,5 mm	€ 5,60	€ 3,30
20...K	120 x 145 mm	4 metri	0,5 mm	€ 5,90	€ 5,30
15...W	160 x 160 mm	6 metri	0,5 mm	€ 5,60	€ 4,90
16...W	220 x 100 mm	6 metri	0,5 mm	€ 5,70	€ 4,50
20...W	160 x 210 mm	6 metri	0,5 mm	€ 5,90	€ 5,90
15...X	250 x 250 mm	10 metri	0,5 mm	€ 7,10	-
16...X	370 x 170 mm	10 metri	0,5 mm	€ 10,00	-
20...X	250 x 310 mm	10 metri	0,5 mm	€ 8,00	-
15...Y	400 x 400 mm	16 metri	0,7 mm	€ 24,60	-
16...Y	580 x 260 mm	16 metri	0,7 mm	€ 35,20	-
20...Y	400 x 500 mm	16 metri	0,7 mm	€ 32,00	-
15...Z	530 x 530 mm	22 metri	0,7 mm	€ 53,20	-
20...Z	530 x 652 mm	22 metri	0,7 mm	€ 62,80	-
15...L	800 x 800 mm	35 metri	1 mm	€ 131,80	-

MATERIALI A RICHIESTA

Segnaletica standard fornita in alluminio piano. Per altri materiali, indicare la sigla P, R o S dopo il codice + lettera formato (esempio 15150WR):

sigla P PVC rigido (dielettrico) spessore 1 mm. Minimo ordinabile 1 pezzo.

sigla R Rifrangente su supporto di alluminio. Minimo ordinabile 1 pezzo.

sigla S Pellicola autoadesiva (solo formato K). Minimo ordinabile 5 pezzi/multipli.



20105 * KWXYZ



20106 * KWXYZ



20107 * KWXYZ

ALTRE LINEE DI SEGNALETICA DI EMERGENZA ALLE PAGINE 94-112.



15150 * W X Y Z L



15152 * KWXYZL



15153 * KWXYZL



15154 * KWXYZL



15155 * W X Y Z



15178 * K W X Y

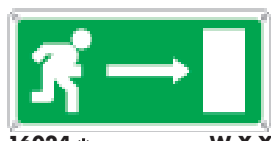

16024 * W X Y

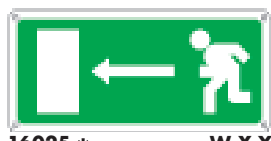

16025 * W X Y

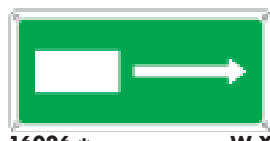

16026 * W X

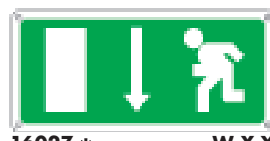

16027 * W X Y

* Simboli contenuti nel D. Lgs. 81 del 09/04/08 Titolo V



CARTELLI BIFACCIALI IN ALLUMINIO

Cartelli bifacciali in alluminio

Linea di segnaletica bifacciale fornita già piegata per un'installazione facile e veloce. Il segnale, nelle versioni normale e fotoluminescente, viene realizzato direttamente su supporto in alluminio. Tutti i cartelli sono disponibili nei formati indicati dalle lettere sotto ogni articolo.

DIMENSIONI DEI CARTELLI BIFACCIALI

CODICE	DIMENSIONI (b x h)	DISTANZA DI LETTURA	SPESSORE ALLUMINIO	PREZZO ALLUMINIO PIANO
15...BIW	160 x 160 mm	6 metri	0,5 mm	€ 17,00
20...BIW	160 x 210 mm	6 metri	0,5 mm	€ 22,00
15...BIX	250 x 250 mm	10 metri	0,5 mm	€ 25,60
20...BIX	250 x 310 mm	10 metri	0,5 mm	€ 33,00
15...BIY	400 x 400 mm	16 metri	0,7 mm	€ 49,60
20...BIY	400 x 500 mm	16 metri	0,7 mm	€ 64,00



CODICE DEL CARTELLO

FORMATI DISPONIBILI



E15101BI W X Y



E15104BI X



15152BI W X Y

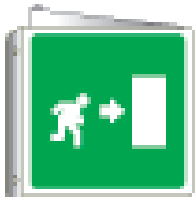

15153BI W X Y



15154BI W X Y



E15156BI W X

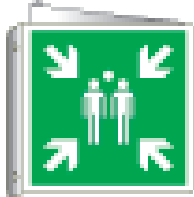

E15180BI W X Y



E20101BI W X Y



E20102BI X



E20114BI X



20107BI W X Y



20106BI W X Y



20105BI W X Y



E20109BI W X

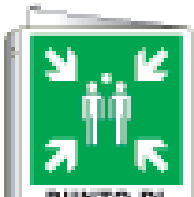

E20153BI W X Y

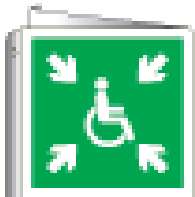

E20195BI X

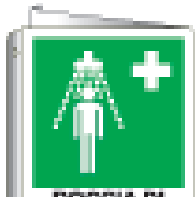

E20103BI W X



E20108BI X



E20104BI X



E20154BI X



E15106BI W X Y



E15107BI W X Y



E15165BI W X Y



E15111BI W X Y



E15115BI W X Y



E15117BI W X Y



E15121BI X



15129BI X Y



E20117BI W X Y



E20177BI X Y



i SIMBOLI NON A NORMA UNI EN ISO 7010. I CARTELLI CON QUESTI SIMBOLI SONO FORNIBILI A RICHIESTA.

SISTEMA DI SEGNALETICA BIFACCIALE E SOSPESA APPLICABILE AI SEGNALI DI EVACUAZIONE DELLE PAG. 78 E 85.

Cartelli bifacciali flessibili in PVC FOLD

Cartelli su supporti in PVC spessore mm 0,5.

DIMENSIONI DEI CARTELLI BIFACCIALI FOLD

CODICE	DIMENSIONI (b x h)	DISTANZA DI LETTURA	PREZZO
E15...BFLK	250 x 250 mm	10 metri	€ 20,40
E71510...BFLX	250 x 120 mm	4 metri	€ 17,20

SEGNALETICA FLESSIBILE NEUTRA PER MAGAZZINI A PAG. 207.



Retro vuoto (colore verde, senza pittogrammi e scritte).



SEGNALETICA BIFACCIALE PLEXICUR

Segnaletica in plexiglass bifacciale

Plexicur è una linea di segnaletica bifacciale semplice ed elegante. Grazie alla sua forma ricurva ricavata da un monoblocco di plexiglass trasparente spessore mm 4, è in grado di adattarsi ad ogni contesto lavorativo. Fornibili con: sistema di fissaggio invisibile e con sistema di fissaggio a vite.

DIMENSIONI DEI CARTELLI BIFACCIALI PLEXICUR

CODICE	TIPOLOGIA DI FISSAGGIO	DIMENSIONI (b x h)	SPORGENZA DAL MURO
SEP20...BIP / SEPE20...BIP	Invisibile	350 x 120 mm	100 mm
SEP20...BDQ / SEPE20...BDQ	A vite	430 x 120 mm	100 mm
SEPE720...BIS	Invisibile	500 x 120 mm	190 mm
SEPE720...BDT	A vite	580 x 120 mm	190 mm

A RICHIESTA FORNIBILI ALTRI SIMBOLI E/O SCRITTE!

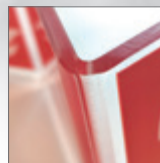

Con sistema di fissaggio invisibile

Si applica al muro con un sistema di fissaggio invisibile (compreso nella fornitura).



SEPE20196BIP



SEP2007BIP



SEPE20150BIP



SEPE720105BIS



SEPE720101BIS



SEPE720104BIS

Con sistema di fissaggio a vite

Si applica al muro con un sistema di fissaggio a vite (compreso nella fornitura).



SEPE20174BDQ



SEPE20153BDQ



SEP2553BDQ



SEPE720101BDT



SEPE720104BDT



SEPE720107BDT



DIMENSIONI DEI CARTELLI DI EMERGENZA

SERIE 16

K - 140 x 70
W - 220 x 100
X - 370 x 170
Y - 580 x 260

CODICE	DIMENSIONI (b x h)	SPESSORE ALLUMINIO	PREZZO ALLUMINIO PIANO	PREZZO PELLICOLA ADESIVA
E16.....K	140 x 70 mm	0,5 mm	€ 5,30	€ 3,90
E16.....W	220 x 100 mm	0,5 mm	€ 5,70	€ 4,50
E16.....X	370 x 170 mm	0,5 mm	€ 10,00	€ 6,00
E16.....Y	580 x 260 mm	0,7 mm	€ 35,20	-

MATERIALI A RICHIESTA

Segnaletica standard fornita in alluminio piano. Per altri materiali, indicare la sigla P, R o S dopo il codice + lettera formato (esempio 16102X**P**):

sigla P PVC rigido (dielettrico) spessore 1 mm. Minimo ordinabile 1 pezzo.

sigla R Rifrangente su supporto di alluminio. Minimo ordinabile 1 pezzo.

sigla S Pellicola autoadesiva (solo formato K). Minimo ordinabile 5 pezzi/multipli.

ELEVATA RESISTENZA E DURATA DEI MATERIALI (VEDI PAGINA 24).

CODICE DEL CARTELLO
FORMATI DISPONIBILI

Grid of emergency signs including: MASCHERE (16102 X), USCITA DI SICUREZZA (16120 W X), APERTURA A SPINTA (16121 X), APERTURA A SPINTA (E16143 W X, E16144 W X), MANIGLIONE ANTIPANICO (16122 X, 16123 W X), USCITA DI EMERGENZA (16124 W X), PER APRIRE SPINGERE IL MANIGLIONE (16125 W X), TIRARE (16126 X), SPINGERE (16127 W X), USARE SOLO IN CASO DI EMERGENZA (16128 X), USCITA DI SICUREZZA NON OSTUIRE LA PORTA APERTURA A SPINTA (16132 X), TELEFONO DI EMERGENZA (16136 W), ATTREZZATURE DI EMERGENZA (16137 X), ATTREZZATURE ANTINCENDIO (16101 X Y), COPERTA ANTIFIAMMA (16106 X Y), ATTACCO DI MANDATA PER AUTOPOMPA Pressione massima 1,2 MPa RETE IDRANTI ANTINCENDIO (16108 X Y), PORTA TAGLIAFUOCO (16210 W X), ATTACCO DI MANDATA PER AUTOPOMPA Pressione massima 1,2 MPa RETE IDRANTI ANTINCENDIO ARCA PROTETTA (16145 X), ATTACCO DI MANDATA PER AUTOPOMPA Pressione massima 1,2 MPa COLUMNA A SICCO PER VILE ARCA SERVITA: _____ MPa (16146 X), ATTACCO AUTOPOMPA W.F. (16109 X), ASCENSORE ANTINCENDIO (16110 W), PORTA REI N° _____ ATTENZIONI! PER MOTIVI DI SICUREZZA ANTINCENDIO QUALE PORTA DEVE RESTARE SEMPRE CHIUSA (16111 W), IN CASO DI INCENDIO NON USARE L'ASCENSORE (E16112 K), IN CASO DI INCENDIO NON USARE L'ASCENSORE (E16133 W), IN CASO DI INCENDIO IN CASE OF FIRE DON'T USE THE LIFT (E16135 W), NON USARE L'ASCENSORE IN CASO D'INCENDIO DO NOT USE THE LIFT IN CASE OF FIRE (E16140 K W), NON USARE L'ASCENSORE IN CASO D'INCENDIO (E16141 W), NON USARE L'ASCENSORE IN CASO D'INCENDIO (E16142 K)

◆ Norma di riferimento: UNI 10779
▲ Simboli contenuti nella Norma ISO 7010

1 TARGA BIFACCIALE TRASPARENTE
Targa in PMMA spessore mm 4 con scritta "Allarme incendio". Foro Ø 120 mm, 4 fori agli angoli.
SEP350 - targa bifacciale mm 350 x 140

2 CARTELLO IN LAMIERA SCATOLATA
Cartello "Attacco di mandata per autopompa..." in lamiera scatolata spessore 1 mm.
FL92216108 - cartello mm 500 x 250

3 ETICHETTA ADESIVA
Etichetta adesiva per identificazione senso di apertura porte con maniglione antipanico.
15055 - etichetta adesiva mm 110 x 110

SEGNALETICA FOTOLUMINESCENTE

CARTLUX® DIN PLUS

CARTLUX® DIN PLUS

La nostra soluzione per la segnalazione di ambienti ad alto, medio e basso rischio di incendio, può essere realizzata su alluminio, alluminio calpestabile autoadesivo antiscivolo, PVC rigido e PVC autoadesivo con luminanza di circa 140 mcd/m² nel rispetto della norma.

LA TECNOLOGIA

I segnali Cartlux® Din Plus sono a base di pigmenti alluminati alcalino terrosi, la cui fotoluminescenza è simile alla luce elettrica. I pigmenti assorbono le onde corte della luce ed immagazzinano l'energia; in caso di oscurità l'energia accumulata viene sprigionata sotto forma di luce. I prodotti Cartlux® Din Plus possono essere riattivati infinite volte e non richiedono manutenzione diversa da quella di un normale segnale di sicurezza.

SICUREZZA DEL PRODOTTO

I prodotti Cartlux® Din Plus sono esenti da elementi radioattivi, non sono tossici, sono senza pericolo per l'utilizzatore nelle normali condizioni d'uso previste.



USCITA DI
EMERGENZA



LA NORMATIVA

- Il D. Lgs. 81/2008 richiama direttamente l'utilizzo di superfici fosforescenti per la realizzazione di cartelli da usarsi in condizioni di cattiva illuminazione naturale (Allegato XXV - Punto 2.1).
- Il D.M. 10 Marzo 1998 prescrive la segnaletica a pavimento per le vaste aree di piano (Allegato III punto 3.8 lettera C).
- La norma UNI 7543 prescrive l'utilizzo di materiali fotoluminescenti per i segnali che devono essere visti in caso di improvvisa mancanza di illuminazione (punto 12: Visibilità dei segnali).
- La norma ISO 16069 prevede una performance paragonabile alla norma DIN67510 oltre a tutti gli elementi per una corretta applicazione della segnaletica delle vie di fuga.



DIMENSIONI DEI CARTELLI LUMINESCENTI CARTLUX[®] DIN PLUS

SERIE EL715

K - 220 x 120
W - 300 x 160
X - 480 x 250

SERIE EL720

K - 320 x 120
W - 440 x 160
X - 710 x 250

MATERIALI

I cartelli sono fornibili in:

- **Alluminio**, aggiungendo "A" dopo la lettera formato (es. EL720101KA);
- **PVC rigido**, aggiungendo "P" dopo la lettera formato (es. EL720101KP).
- **Pellicola autoadesiva**, aggiungendo "S" dopo la lettera formato (es. EL720101KS). Solo nei formati K e W (confezioni da 5 pezzi per articolo)

CODICE	DIMENSIONI (b x h)	DISTANZA DI LETTURA	PREZZO ALLUMINIO PIANO (A)	PREZZO PVC RIGIDO (P)	PREZZO PELLICOLA ADESIVA (S)
EL715.....K	220 x 120 mm	4 metri	€ 14,40	€ 9,40	€ 9,40
EL720.....K	320 x 120 mm	4 metri	€ 18,00	€ 11,60	€ 11,60
EL715.....W	300 x 160 mm	6 metri	€ 17,80	€ 11,40	€ 11,40
EL720.....W	440 x 160 mm	6 metri	€ 20,40	€ 12,60	€ 12,60
EL715.....X	480 x 250 mm	10 metri	€ 29,25	€ 23,40	-
EL720.....X	710 x 250 mm	10 metri	€ 40,00	€ 32,00	-

CODICE DEL CARTELLO FORMATI DISPONIBILI



EL715101 K W X



EL715102 K W X



EL715103 K W X



EL715104 K W X



EL715105 K W X



EL715106 K W X



EL715107 K W X



EL715108 K W X



EL720101 K W X



EL720102 K W X



EL720103 K W X



EL720104 K W X



EL720105 K W X



EL720106 K W X



EL720107 K W X



EL720108 K W X



EL720201 K W X



EL720202 K W X



EL720203 K W X



EL720204 K W X



EL720205 K W X



EL720206 K W X



EL720207 K W X



EL720208 K W X



EL720301 K W X



EL720302 K W X



EL720303 K W X



EL720304 K W X



EL720305 K W X



EL720306 K W X



EL720307 K W X



EL720308 K W X



BIFACCIALE SOSPESO
COD. EL720101SK

BIFACCIALE A BANDIERA
COD. EL715104BK

TUTTI I SEGNALI DI QUESTA PAGINA POSSONO ESSERE REALIZZATI IN VERSIONE BIFACCIALE (SOLO NEI FORMATI K E W), AGGIUNGENDO "B" (BIFACCIALE A BANDIERA - ATTACCO PREVISTO A SINISTRA) O "S" (BIFACCIALE SOSPESA) PRIMA DELLA LETTERA FORMATO.

Il retro vuoto (senza pittogrammi e scritte) si riferisce solo alle versioni bifacciale a bandiera e bifacciale sospesa.



DIMENSIONI DEI CARTELLI LUMINESCENTI CARTLUX® DIN PLUS

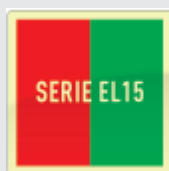

K - 120 x 120
W - 160 x 160
X - 250 x 250
Y - 400 x 400



K - 120 x 145
W - 160 x 210
X - 250 x 310
Y - 400 x 500

MATERIALI

I cartelli sono fornibili in:

- **Alluminio**, aggiungendo "A" dopo la lettera formato (es. EL15101KA);
- **PVC rigido**, aggiungendo "P" dopo la lettera formato (es. EL15101KP).
- **Pellicola autoadesiva**, aggiungendo "S" dopo la lettera formato (es. EL15101KS). Solo nei formati K e W (confezioni da 5 pezzi per articolo)

! NELLA NORMA ISO 7010 LE FRECCE SUPPLEMENTARI E15104 ED E15105 SONO DA UTILIZZARSI ABBINATE AI SEGNALE USCITA DI EMERGENZA E15153, E15154, E20105 E E20106 PER DARE L'INFORMAZIONE SULLA DIREZIONE.



CODICE	DIMENSIONI (b x h)	DISTANZA DI LETTURA	PREZZO ALLUMINIO PIANO (A)	PREZZO PVC RIGIDO (P)	PREZZO PELLICOLA ADESIVA (S)
EL15...K	120 x 120 mm	4 metri	€ 12,60	€ 9,70	€ 9,70
EL20...K	120 x 145 mm	4 metri	€ 16,70	€ 13,00	€ 13,00
EL15...W	160 x 160 mm	6 metri	€ 16,10	€ 11,80	€ 11,80
EL20...W	160 x 210 mm	6 metri	€ 18,10	€ 14,60	€ 14,60
EL15...X	250 x 250 mm	10 metri	€ 32,30	€ 26,00	-
EL20...X	250 x 310 mm	10 metri	€ 39,00	€ 31,00	-
EL15...Y	400 x 400 mm	16 metri	€ 53,00	€ 43,00	-
EL20...Y	400 x 500 mm	16 metri	€ 58,00	€ 47,00	-



CARTELLI CON SIMBOLI NON A NORMA UNI EN ISO 7010 FORNIBILI A RICHIESTA.

CODICE DEL CARTELLO FORMATI DISPONIBILI



EL15101 • K W X Y



EL15104 • K W X Y



EL15105 • K W X Y



EL15153 • K W X Y



EL15154 • K W X Y



EL15221 • K



EL15231 • K



EL15116 • X



EL15179 • X

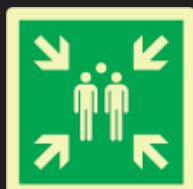

EL15180 • X Y



EL15106 ■ K W X Y



EL15107 • K W X Y



EL15115 • K W X Y



EL15117 • W



L15147 • W X



EL15167 • K W X



EL15111 • W X



EL15165 WX ■



EL20162 • K W X



EL20102 • W X Y



EL20105 • K W X Y



EL20106 • K W X Y



L20132 • KX



EL20154 • K W X

■ Simboli contenuti nella Norma UNI 7546
● Simboli contenuti nella Norma UNI EN ISO 7010



EL20117 ■ K W X Y



EL20121 ● K W X Y



EL20118 ● K W X Y



EL20150 ● K W X



EL20157 ● K W X Y



EL20160 ● W X Y

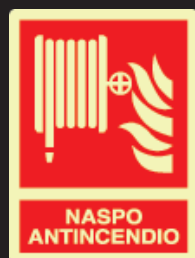

EL20168 ● X



EL20163 ● K W X



EL20140 ● K W X



EL20174 ● K X

! DECRETO LEGISLATIVO 81/2008 - ALLEGATO XXV PUNTO 2.1. CONDIZIONI DI IMPIEGO: IN CASO DI CATTIVA ILLUMINAZIONE NATURALE SARÀ OPPORTUNO UTILIZZARE COLORI FOSFORESCENTI, MATERIALI RIFLETTENTI O ILLUMINAZIONE ARTIFICIALE. DECRETO MINISTERIALE 10 MARZO 1998 - ALLEGATO III PUNTO 3.8 LETTERA C. SEGNALETICA A PAVIMENTO: NEL CASO IN CUI UN PERCORSO DI ESODO ATTRAVERSI UNA VASTA AREA DI PIANO, IL PERCORSO STESSO DEVE ESSERE CHIARAMENTE DEFINITO ATTRAVERSO IDONEA SEGNALETICA A PAVIMENTO.

Cartelli fotoluminescenti Cartlux[®] DIN PLUS D. Lgs. 81/08

DIMENSIONI DEI CARTELLI LUMINESCENTI CARTLUX[®] DIN PLUS

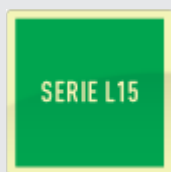

CODICE	DIMENSIONI (b x h)	DISTANZA DI LETTURA	PREZZO ALLUMINIO PIANO (A)	PREZZO PVC RIGIDO (P)	PREZZO PELLICOLA ADESIVA (S)
L15...K	120 x 120 mm	4 metri	€ 12,60	€ 9,70	€ 9,70
L20...K	120 x 145 mm	4 metri	€ 16,70	€ 13,00	€ 13,00
L15...W	160 x 160 mm	6 metri	€ 16,10	€ 11,80	€ 11,80
L16...W	220 x 100 mm	6 metri	€ 16,10	€ 14,60	€ 14,60
L20...W	160 x 210 mm	6 metri	€ 18,10	€ 26,00	-
L15...X	250 x 250 mm	10 metri	€ 32,30	€ 31,00	-
L16...X	370 x 170 mm	10 metri	€ 35,00	€ 43,00	-
L20...X	250 x 310 mm	10 metri	€ 39,00	€ 47,00	-
L15...Y	400 x 400 mm	16 metri	€ 53,00	€ 53,00	-
L20...Y	400 x 500 mm	16 metri	€ 58,00	€ 58,00	-

MATERIALI

I cartelli sono fornibili in:

- **Alluminio**, aggiungendo "A" dopo la lettera formato (es. EL15101KA);
- **PVC rigido**, aggiungendo "P" dopo la lettera formato (es. EL15101KP).
- **Pellicola autoadesiva**, aggiungendo "S" dopo la lettera formato (es. EL15101KS). Solo nei formati K e W (confezioni da 5 pezzi per articolo)



L15150 WX *



L15152 KWXY *

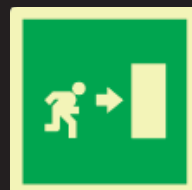

L15153 KWXY *

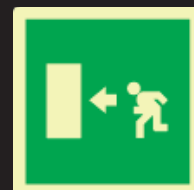

L15154 KWXY *



L20105 KWXY *



L20106 KWXY *



L20107 KWXY *



L15155 WX *



VERSIONE BIFACCIALE A PAGINA 88.



L16024 WX *

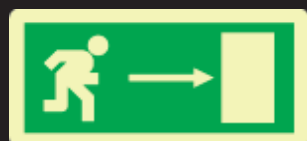

L16025 WX *



L16026 WX *

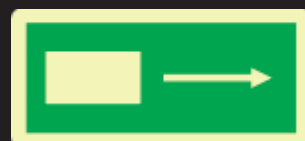

L16027 WX *



L16028 WX *

* Simboli contenuti nel D. Lgs. 81 del 09/04/08 Titolo V



Cartelli bifacciali fotoluminescenti serie CARTLUX[®] DIN PLUS

Segnaletica bifacciale pre-piegata. I cartelli sono forniti in **alluminio fotoluminescente**: in fase d'ordine, aggiungere "A" dopo la lettera formato (es. EL15101BIWA).



DIMENSIONI DEI CARTELLI BIFACCIALI CARTLUX[®] DIN PLUS

CODICE	DIMENSIONI (b x h)	DISTANZA DI LETTURA	SPESSORE ALLUMINIO	PREZZO ALLUMINIO PIANO (A)
EL15/L15..BIW	160 x 160 mm	6 metri	0,5 mm	€ 34,20
EL20/L20..BIW	160 x 210 mm	6 metri	0,5 mm	€ 35,20
EL15/L15..BIX	250 x 250 mm	10 metri	0,5 mm	€ 65,60
EL20/L20..BIX	250 x 310 mm	10 metri	0,5 mm	€ 67,60
EL15/L15..BIY	400 x 400 mm	16 metri	0,7 mm	€ 107,00
EL20/E20..BIY	400 x 500 mm	16 metri	0,7 mm	€ 110,00

CODICE DEL CARTELLO FORMATI DISPONIBILI



EL15101BI • W X Y

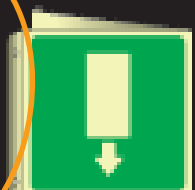

L15152BI • W X Y

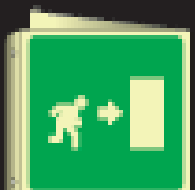

L15153BI * W X Y

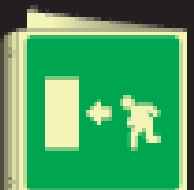

L15154BI * W X Y

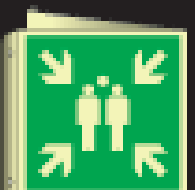

EL15180BI • X Y



L20105BI * W X Y



L20106BI * W X Y



L20107BI • W X Y



EL15107BI • W X Y



EL15111BI • W X



EL15115BI • W X Y



EL15117BI • W



EL15165BI • W X



EL20118BI • W X Y



EL20157BI • W X Y



EL20150BI • W X

ALTRE LINEE DI SEGNALETICA DI SICUREZZA ALLE PAGINE 94-112.



EL20160BI • W X Y



EL20165BI • X



EL20168BI • X

ALTRI PITTOGRAMMI E FORMATI BIFACCIALI ALLE PAGINE 80, 81 E 82.

ALTRI SIMBOLI FORNIBILI A RICHIESTA.

* Simboli contenuti nel D. Lgs. 81 del 09/04/08 Titolo V
● Simboli contenuti nella Norma UNI EN ISO 7010

Segnalazione orizzontale da pavimento profili e frecce fotoluminescenti

DIMENSIONI SEGNALETICA ORIZZONTALE E PROFILI

CODICE	DIMENSIONI	MATERIALE	CONFEZIONE	PREZZO
L91..	230 x 110 mm	Alluminio autoadesivo 0,5 mm	5 pezzi	€ 30,00
L9460	∅ 160 mm	Alluminio autoadesivo 0,5 mm	5 pezzi	€ 17,80



EL9161



L9162



L9460



Cartelli fotoluminescenti vari

DIMENSIONI DEI CARTELLI LUMINESCENTI CARTLUX[®] DIN PLUS

CODICE	DIMENSIONI (b x h)	PREZZO PVC RIGIDO (P)	PREZZO PELLICOLA ADESIVA (S)
EL16/L16...K	140 x 70 mm	€ 11,00	-
EL16/L16...W	220 x 100 mm	€ 12,60	€ 12,60
EL16/L16...X	370 x 170 mm	€ 28,00	€ 26,60

MATERIALI

I cartelli sono fornibili in:

- **PVC rigido**, aggiungendo "P" dopo la lettera formato (es. L16103XP).
- **Pellicola autoadesiva**, aggiungendo "S" dopo la lettera formato (es. L16103XS). Solo nei formati W e X (confezioni da 5 pezzi per articolo)

 RESPIRATORI L16103 X	 USCITA DI SICUREZZA L16120 W X	 APERTURA A SPINTA L16121 X	 APERTURA A SPINTA L16143 ● W X	 APERTURA A SPINTA L16144 ● W X	 MANIGLIONE ANTIPANICO L16122 X
 MANIGLIONE ANTIPANICO apertura a spinta L16123 W X	 USCITA DI EMERGENZA L16124 W X	 PER APRIRE SPINGERE IL MANIGLIONE L16125 W X	 TIRARE L16126 X	 SPINGERE L16127 X	 USARE SOLO IN CASO DI EMERGENZA L16128 X
 MANIGLIONE ANTIPANICO apertura a spinta L16130 X	 INTERRUTTORE ELETTRICO GENERALE L16131 W	 USCITA DI SICUREZZA NON OSTUIRE LA PORTA APERTURA A SPINTA L16132 X	 TELEFONO DI EMERGENZA L16136 W	 ATTREZZATURE DI EMERGENZA L16137 X	 ATTREZZATURE ANTINCENDIO L16101 X
 ATTACCO DI MANDATA PER AUTOPOMPA Pressione massima 1,2 MPa RETE IORANTI ANTINCENDIO L16108 ◆ X	 IN CASO DI INCENDIO NON USARE L'ASCENSORE L16133 W	 IN CASO DI INCENDIO IN CASE OF FIRE NON USARE L'ASCENSORE DON'T USE THE LIFT L16135 W	 NON USARE L'ASCENSORE IN CASO D'INCENDIO DO NOT USE THE LIFT IN CASE OF FIRE L16140 K W	 NON USARE L'ASCENSORE IN CASO D'INCENDIO DO NOT USE THE LIFT IN CASE OF FIRE L16142 K	

Cartelli di divieto e pericolo fotoluminescenti

DIMENSIONI DEI CARTELLI LUMINESCENTI

CODICE	FORMATO	PREZZO ALLUMINIO PIANO (A)	PREZZO PVC RIGIDO (P)	PREZZO PELLICOLA ADESIVA (S)
EL13..K	120 x 120 mm	€ 12,25	€ 9,80	€ 9,80
EL13..W	166 x 166 mm	€ 19,75	€ 15,80	€ 15,40
EL17..K	350 x 125 mm	€ 24,00	€ 19,20	€ 19,60
EL18.K / L18.K	350 x 125 mm	€ 24,00	€ 19,20	€ 19,60
EL29..	500 x 333 mm	€ 58,00	€ 47,00	€ 47,00
EL35..	300 x 200 mm	€ 39,00	€ 31,00	€ 31,00

MATERIALI

I cartelli sono fornibili in:

- **Alluminio**, aggiungendo "A" dopo la lettera formato (es. EL1710KA);
- **PVC rigido**, aggiungendo "P" dopo la lettera formato (es. EL1710KP).
- **Pellicola autoadesiva**, aggiungendo "S" dopo la lettera formato (es. EL1710KS). Solo nei formati W e X (confezioni da 5 pezzi per articolo)

 ATTENZIONE MATERIALI INFIAMMABILI L1710 ● K	 ATTENZIONE CORRENTE ELETTRICA L1743 ● K	 VIETATO FUMARE L1801 ● K	 IN CASO DI INCENDIO NON USARE L'ASCENSORE L13536 EL2939 (discesa sx) L13538 (salita sx) L13537 EL2940 (discesa dx) L13539 (salita dx)
 VIETATO FUMARE NO SMOKING DEFENSE DE FUMER RAUCHEN VERBOTEN L1802 ● K	 VIETATO L'INGRESSO a tutte le persone non autorizzate L1809 ● K	 VIETATO L'ACCESSO a chi non è autorizzato L1813 ● K	
 QUI NON USARE ACQUA PER SPEGNERE INCENDI L1823 ● K	 NON USARE ACQUA per spegnere incendi su apparecchiature elettriche L1824 K ● K	 NON USARE IN CASO DI INCENDIO L1845 ● K	
 L1301 ● K W	 L1304 ● K	 L1305 ● K W	 L1306 ● K W

* Simboli contenuti nel D. Lgs. 81 del 09/04/08 Titolo V
● Simboli contenuti nella Norma UNI EN ISO 7010



SEGNALETICA FOTOLUMINESCENTE VARIA

Nastri e accessori fotoluminescenti autoadesivi

L'elevato effetto luminescente permette, in caso black-out, di segnalare nel buio più completo: uscite, soglie, scale, corridoi, maniglie, quadri elettrici, equipaggiamenti di sicurezza o antincendio, ostacoli, ecc. Le strisce alternate rosse o verdi rendono segnaletico il nastro anche in normali condizioni di luce.

NASTRI FOTOLUMINESCENTI

- 1 L9210** - nastro, h 2 cm x 10 m
- L9410** - nastro, h 4 cm x 10 m
- L9510** - nastro, h 5 cm x 10 m
- 2 L9421** - nastro h 4 cm x 10 m, colore giallo/rosso
- 3 L9422** - nastro h 4 cm x 10 m, colore giallo/verde
- 4 L9423** - nastro h 4 cm x 10 m, con frecce

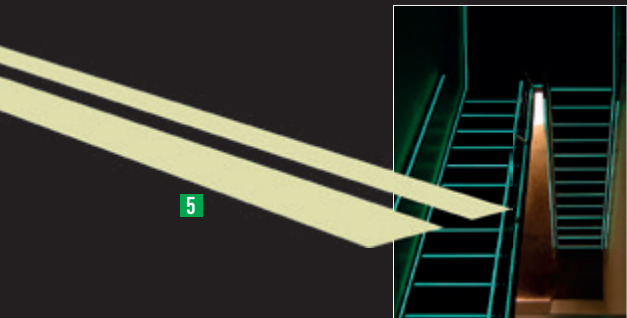
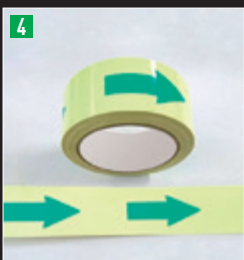

5 STRISCE FOTOLUMINESCENTI

- L905** - striscia fotoluminescente 50 x 1000 mm, confezione da 5 pezzi **€ 19,80**
- L910** - striscia fotoluminescente 100 x 1000 mm **€ 39,40**



FRECCIE FOTOLUMINESCENTI

- 6 L9435** - freccia a punta, mm 132 x 189, minimo ordinabile 10 pezzi/multipli **€ 10,60**
- 7 L9430** - freccia stondata, mm 107 x 105, minimo ordinabile 10 pezzi/multipli **€ 5,30**

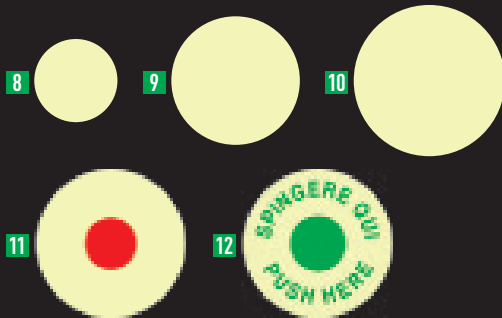

BOLLI FOTOLUMINESCENTI

- 8 L9440** - bollo Ø 40 mm, minimo ordinabile 10 pezzi/multipli **€ 2,70**
- 9 L9465** - bollo Ø 65 mm, minimo ordinabile 10 pezzi/multipli **€ 3,40**
- 10 L9475** - bollo Ø 75 mm, confezione da 10 pezzi **€ 4,50**
- 11 L94751** - bollo Ø 75 mm, minimo ordinabile 10 pezzi/multipli **€ 5,10**
- 12 L94752** - bollo Ø 75 mm, minimo ordinabile 10 pezzi/multipli **€ 5,10**



USCITA EMERGENZA

Dimensioni mm 120 x 330, minimo ordinabile 5 pezzi/multipli.

- 13 EL12033D** - uscita di emergenza, orientamento a destra
- 14 EL12033S** - uscita di emergenza, orientamento a sinistra

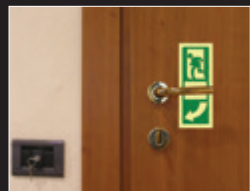

Striscia e cartello fotoluminescente per estintori



- L3560 S** PVC autoadesivo mm 300 x 200 **€ 30,00**
- L3560 P** PVC rigido mm 300 x 200 **€ 29,80**



- L3568P** PVC rigido mm 300 x 200 **€ 29,80**



- L2973P** PVC rigido mm 333 x 500 **€ 70,20**



- L3569P** PVC rigido mm 300 x 200 **€ 29,80**

- L9130** Striscia in PVC autoadesivo mm 620 x 30 per estintori da kg 6 - 9 - 12. Minimo ordinabile 5 pezzi/multipli. **€ 9,80**

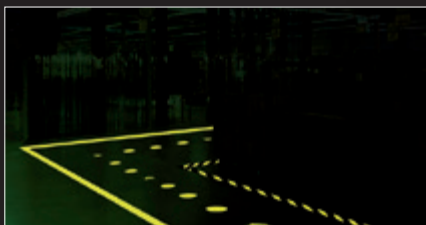

STRISCE ANTISCIVOLO, BOLLI E FRECCE

Strisce, frecce e bolli di segnalazione antiscivolo in policarbonato autoadesivo fotoluminescente. Indicati per la segnalazione da pavimento e/o scale in aree di produzione e magazzini.

- 1 L93060** - bollo neutro fotoluminescente, Ø mm 60. Minimo ordinabile 10 pezzi/multipli
- L93100** - bollo neutro fotoluminescente, Ø mm 100. Minimo ordinabile 10 pezzi/multipli
- 2 L93061** - bollo con freccia fotoluminescente, Ø mm 60. Minimo ordinabile 10 pezzi/multipli
- L93101** - bollo con freccia fotoluminescente, Ø mm 100. Minimo ordinabile 10 pezzi/multipli
- 3 L93415** - striscia fotoluminescente giallo/nera, h mm 50 x 800
- 4 L93215** - striscia neutra fotoluminescente, altezza mm 50 x 800
- 5 L93212** - striscia neutra fotoluminescente, altezza mm 25 x

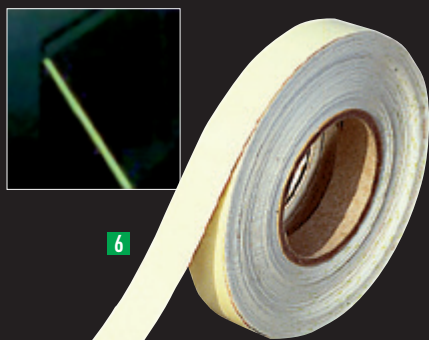
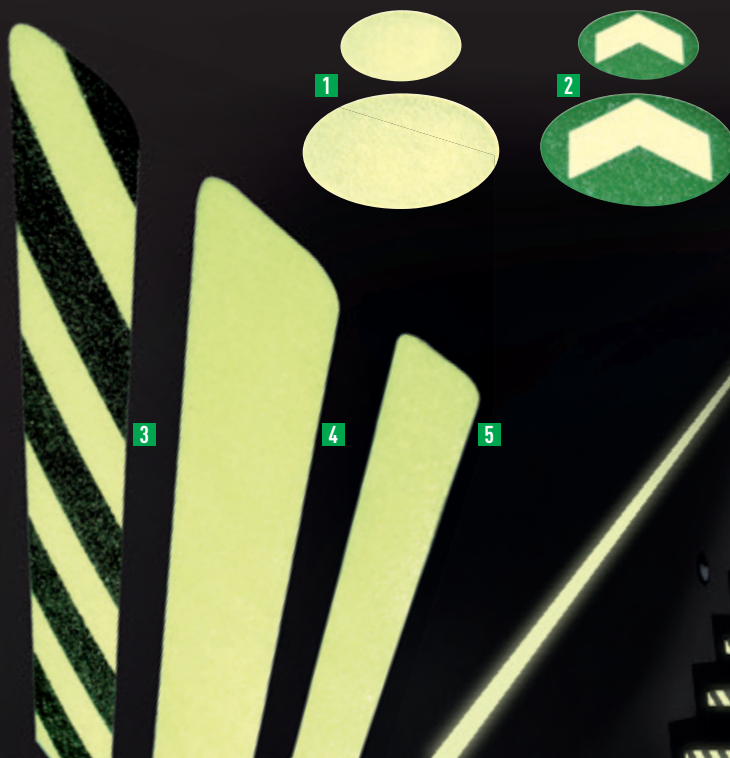

6



ANGOLARI FOTOLUMINESCENTI AUTOADESIVI

Antiscivolo, per la segnalazione delle scale da installarsi ai lati o sullo spigolo degli scalini.

- 7 L93200** - angolare neutro in alluminio, dimensioni mm 50 x 25 x 200
- 8 L93201** - angolare con freccia verso il basso in alluminio, dimensioni mm 50 x 25 x 200
- 9 L93202** - angolare freccia verso l'alto in alluminio, dimensioni mm 50 x 25 x 200



6 NASTRO PER CORRIMANO

Nastro autoadesivo fotoluminescente in PVC. Si carica con qualsiasi fonte di luce e completa la gamma di articoli luminescenti previsti per indicare le vie di fuga in condizioni di scarsa illuminazione naturale. Può essere applicato su ringhiere e corrimani ed essere tagliato a piacere a seconda delle esigenze.

L93329 - rotolo autoadesivo fotoluminescente da 10 m, larghezza mm 25, spessore mm 0,56



10 BORDO IN ALLUMINIO PER GRADINI

Bordo autoadesivo in alluminio per gradini con 2 bande antiscivolo fotoluminescenti che emettono luce in caso di scarsa visibilità rendendo le scale visibili anche di notte. 2 bande, 1 fotoluminescente e 1 nera, entrambe antiscivolo da 19 mm x 1 mt. Una banda aggiuntiva fotoluminescente è di 25 mm per 1 mt.

L93517 - bordo di protezione autoadesivo in alluminio, dimensioni 66 x 30 x 1000 mm

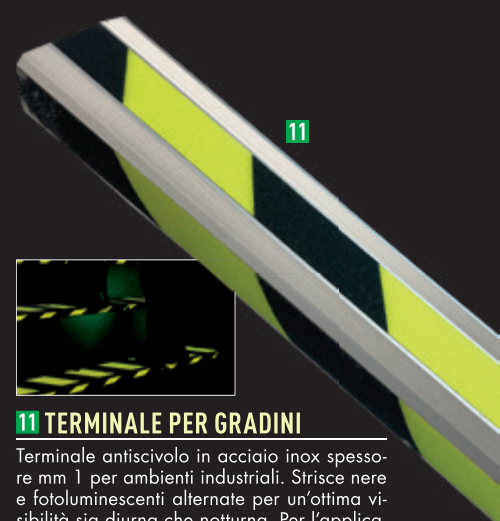

11 TERMINALE PER GRADINI

Terminale antiscivolo in acciaio inox spessore mm 1 per ambienti industriali. Strisce nere e fotoluminescenti alternate per un'ottima visibilità sia diurna che notturna. Per l'applicazione utilizzare 8 viti (non fornite). Lunghezza terminale m 1, spessore totale 2 mm.

L93712 - terminale antiscivolo in acciaio inox, dimensioni 110 x 30 mm



I.M.O. (International Maritime Organization)

Simboli in applicazione alle norme di salvataggio e sicurezza sul mare e di evacuazione delle navi.

DIMENSIONI DEI CARTELLI LUMINESCENTI I.M.O. CARTLUX® DIN PLUS

CODICE	DIMENSIONI (b x h)	PREZZO PVC RIGIDO (P)	PREZZO PELLICOLA ADESIVA (S)
L15..XP	250 x 250 mm	€ 26,00	-
L97..P	75 x 150 mm	€ 9,10	-
L97..S	75 x 150 mm	-	€ 9,10
L98..P	150 x 150 mm	€ 13,60	-
L98..S	150 x 150 mm	-	€ 13,60

MATERIALI

I cartelli sono fornibili in:

- **PVC rigido**, aggiungendo "P" dopo la lettera formato (es. L9801P).
- **Pellicola autoadesiva**, aggiungendo "S" dopo la lettera formato (es. L9801S).

Cartelli d'obbligo

Comportamenti obbligatori sui mezzi di salvataggio.

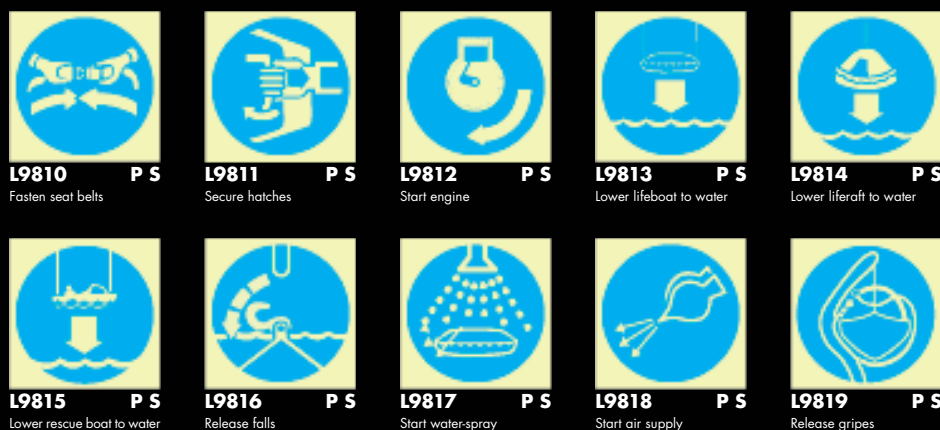

Cartelli di sicurezza

Indicazione di equipaggiamenti di emergenza e punti di raccolta sulla nave).



L15181X
Lettera A

Per le altre lettere, inserire i seguenti codici:

L15182X - lettera B
L15183X - lettera C
L15184X - lettera D
L15186X - lettera E
L15186X - lettera F
L15187X - lettera G
L15188X - lettera H
L15189X - lettera I
L15190X - lettera L
L15191X - lettera M
L15192X - lettera N
L15193X - lettera O



L9704
Numero 4

Per gli altri numeri, inserire i seguenti codici:

L9700 - numero 0
L9701 - numero 1
L9702 - numero 2
L9703 - numero 3
L9705 - numero 5
L9706 - numero 6
L9707 - numero 7
L9708 - numero 8
L9709 - numero 9



PRIMO SOCCORSO

ALTA

VISIBILITÀ



Armadi e valigette di primo soccorso sono dispositivi di fondamentale importanza per la sicurezza aziendale. In caso di emergenza, quando qualcuno è ferito, è necessario agire rapidamente, per somministrare le prime cure. SafeIn® vi propone una linea esclusiva di valigette e armadi di colore giallo fluorescente, altamente visibili nelle situazioni in cui la presenza di luce è scarsa o addirittura assente. L'esclusivo colore dei nostri dispositivi, in contrasto con l'ambiente circostante, li rende molto più facili da individuare. Armadi e valigette sono disponibili con i contenuti prescritti dall'Allegato 1 e 2.



**VALIGETTE
ALLEGATO 1
E ALLEGATO 2**



**ARMADI
ALLEGATO 1
E ALLEGATO 2**



PLEXI

SEGNALETICA IN PLEXIGLASS

PLEXI: VERSIONE MONOFACCIALE CON FISSAGGIO A VITE

Elegante sistema di segnaletica di sicurezza costituito da uno o più supporti (in base alle versioni) in plexiglass, con angoli smussati, fornibile con i più comuni pittogrammi. Spessore lastra plexiglass mm 4. Disponibile anche nella versione luminescente. La versione monofacciale si applica al muro con un **sistema di fissaggio a vite** (distanza dal muro mm 13), compreso nella fornitura.

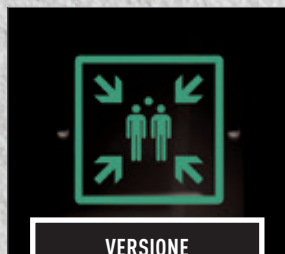

VERSIONE
FOTOLUMINESCENTE!



VERSIONE CON SISTEMA DI FISSAGGIO A VITE



VERSIONE CON SISTEMA DI FISSAGGIO INVISIBILE

PLEXI: VERSIONE MONOFACCIALE CON FISSAGGIO INVISIBILE

Elegante sistema di segnaletica di sicurezza costituito da uno o più supporti (in base alle versioni) in plexiglass, con angoli smussati, fornibile con i più comuni pittogrammi. Spessore lastra plexiglass mm 4. Disponibile anche nella versione luminescente. La versione monofacciale si applica al muro con un **sistema invisibile** che si applica alla parete (distanza dal muro mm 10), compreso nella fornitura.

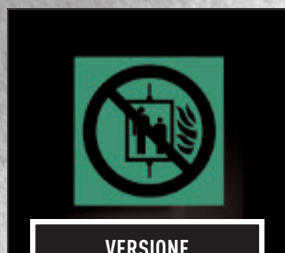

VERSIONE
FOTOLUMINESCENTE!





LINEA PLEXI VERSIONE PER PLANIMETRIE

Targa singola in plexiglass 460 x 300 mm ideale per planimetrie. Il plexiglass dona all'immagine un senso di profondità offrendo un effetto simile a quello del vetro, pur restando un materiale leggero e infrangibile. La trasparenza rende il plexiglass il materiale ideale per installazioni di forte impatto visivo. La planimetria (dimensioni 420 x 260 mm) viene stampata direttamente sul retro della targa. Utilizzo verticale o orizzontale. I codici SEPP e SEPPF non includono la stampa, mentre con i codici SEPPST e SEPPFST (stampa inclusa) occorre fornire il file esecutivo di stampa.

DIMENSIONI DELLE PLANIMETRIE PLEXI

CODICE	SISTEMA DI FISSAGGIO	STAMPA GRAFICA
SEPP	A vite	Esclusa
SEPPST	A vite	Inclusa
SEPPF	Invisibile	Esclusa
SEPPFST	Invisibile	Inclusa

A RICHIESTA È FORNIBILE LA VOSTRA PLANIMETRIA RIELABORATA SECONDO LA NORMA UNI ISO 23601:2009 (RICHIEDERE PREVENTIVO).



SI APPLICA AL MURO CON UN SISTEMA DI FISSAGGIO INVISIBILE (COMPRESO NELLA FORNITURA).

SI APPLICA AL MURO CON UN SISTEMA DI FISSAGGIO A VITE (COMPRESO NELLA FORNITURA).

SEGNALETICA IN PLEXIGLASS BIFACCIALE

PLEXICUR

VEDI PAGINA 82

Plexicur è un segnale bifacciale semplice ed elegante. Grazie alla sua forma ricurva ricavata da un monoblocco di plexiglass trasparente piegato, è in grado di adattarsi ad ogni contesto lavorativo.



FORMA RICURVA ED ELEGANTE



PLEXIGLASS SPESSORE 4 MM





LINEA PLEXI MONOFACCIALE CON SISTEMA DI FISSAGGIO A VITE

Supporto in plexiglass (spessore mm 4) con angoli smussati, fornibile con i simboli raffigurati in questa pagina. Altri simboli fornibili a richiesta (richiedere preventivo). Si applica al muro con un sistema di fissaggio a vite (distanza dal muro mm 13), compreso nella fornitura.



SI APPLICA AL MURO CON UN SISTEMA DI FISSAGGIO A VITE (COMPRESO NELLA FORNITURA).



PER LA VERSIONE FOTOLUMINESCENTE DEL SEGNALE, IN FASE D'ORDINE AGGIUNGERE LA LETTERA S DOPO LA SIGLA SEP.

DIMENSIONI DEI PLEXI MONOFACCIALI A VITE

CODICE	DIMENSIONI (b x h)	VERSIONE
SEP.....W	200 x 200 mm	normale
SEPS.....W	200 x 200 mm	fotoluminescente
SEPE715...R	340 x 250 mm	normale
SEPE715...R	340 x 310 mm	fotoluminescente



SEPE15101W
Pronto soccorso

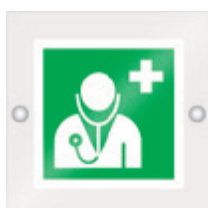

SEPE15118W
Personale medico

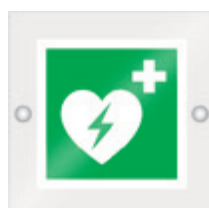

SEPE15156W
Defibrillatore

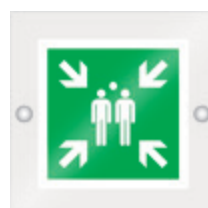

SEPE15180W
Punto d'incontro



SEPE15106W
Idrante

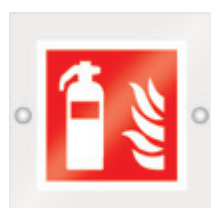

SEPE15107W
Estintore



SEPE15111W
Presidio antincendio

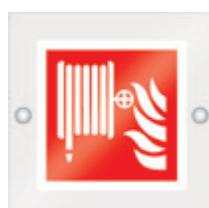

SEPE15115W
Lancia antincendio

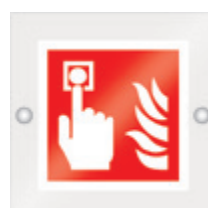

SEPE15117W
Pulsante allarme antincendio



SEPE1301W
Vietato fumare

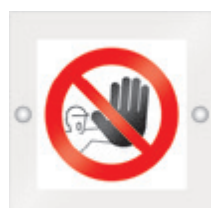

SEP1312W
Vietato l'accesso

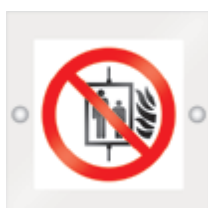

SEPE1347W
Vietato usare l'ascensore



SEPE5008W
Area videosorvegliata

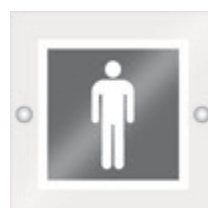

SEP15642W
Toilette uomo

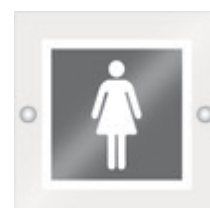

SEP15643W
Toilette donna

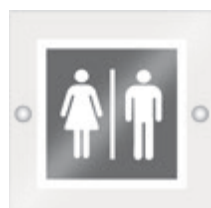

SEP15644W
Toilette uomo/donna



SEP15653W
Toilette disabili



SEPE715101R
Uscita emergenza sinistra



SEPE715102R
Uscita emergenza destra



SEPE715103R
Uscita emergenza avanti/alto



SEPE715104R
Uscita emergenza basso



SEPE715105R
Uscita emergenza in alto a sinistra



SEPE715106R
Uscita emergenza in alto a destra



SEPE715107R
Uscita emergenza in basso a sinistra



SEPE715108R
Uscita emergenza in basso a destra



LINEA PLEXI MONOFACCIALE CON SISTEMA DI FISSAGGIO INVISIBILE

Supporto in plexiglass (spessore mm 4) con angoli smussati, fornibile con i simboli raffigurati in questa pagina. Altri simboli fornibili a richiesta (richiedere preventivo). Si fissa al muro con un sistema invisibile che si applica alla parete (distanza dal muro mm 10), compreso nella fornitura.

DIMENSIONI DEI PLEXI MONOFACCIALI INVISIBILE

CODICE	DIMENSIONI (b x h)	VERSIONE
SEP.....FW	200 x 200 mm	normale
SEPS.....FW	200 x 200 mm	fololuminescente
SEPE160F	160 x 112 mm	normale
SEPE160F	160 x 112 mm	fololuminescente
SEPE715...FR	340 x 250 mm	normale
SEPE715...FR	340 x 310 mm	fololuminescente



PER LA VERSIONE FOTOLUMINESCENTE DEL SEGNALE, IN FASE D'ORDINE AGGIUNGERE LA LETTERA S DOPO LA SIGLA SEP.



 SEPE15101FW Pronto soccorso	 SEPE15118FW Personale medico	 SEPE15156FW Defibrillatore	 SEPE15180FW Punto d'incontro	 SEPE15106FW Idrante
 SEPE15107FW Estintore	 SEPE15111FW Presidio antincendio	 SEPE15115FW Lancia antincendio	 SEPE15117FW Pulsante allarme antincendio	 SEPE1301FW Vietato fumare
 SEP1312FW Vietato l'accesso	 SEP1347FW Vietato usare l'ascensore	 SEP5008FW Area videosorvegliata	 SEPE715101FR Uscita emergenza sinistra	 SEPE715102FR Uscita emergenza destra
 SEP15642FW Toilette uomo	 SEP15643FW Toilette donna	 SEP15644FW Toilette uomo/donna	 SEPE715103FR Uscita emergenza avanti/alto	 SEPE715104FR Uscita emergenza basso
 SEP15653FW Toilette disabili	 SEPE160F Non usare l'ascensore		 SEPE715105FR Uscita emergenza in alto a sinistra	 SEPE715106FR Uscita emergenza in alto a destra
			 SEPE715107FR Uscita emergenza in basso a sinistra	 SEPE715108FR Uscita emergenza in basso a destra



LINEA PLEXI BIFACCIALE A BANDIERA

Sistema di segnaletica composto da due supporti accoppiati in plexi-glass (spessore mm 4) con angoli smussati, disponibile con i simboli raffigurati in questa pagina. Altri simboli fornibili a richiesta (richiedere preventivo). Si applica al muro con un sistema di fissaggio applicabile alla parete mediante 2 tasselli (compresi nella fornitura).



SI APPLICA AL MURO CON UN SISTEMA DI FISSAGGIO A VITE (COMPRESO NELLA FORNITURA).

PER LA VERSIONE FOTOLUMINESCENTE DEL SEGNALE, IN FASE D'ORDINE AGGIUNGERE LA LETTERA S DOPO LA SIGLA SEP.



DIMENSIONI DEI PLEXI BIFACCIALI A BANDIERA

CODICE	DIMENSIONI (b x h)	VERSIONE
SEP.....BW	200 x 200 mm	normale
SEPS.....BW	200 x 200 mm	fotoluminescente
SEPE160B	340 x 250 mm	normale
SEPSE160B	340 x 310 mm	fotoluminescente



SEPE15101BW
Pronto soccorso



SEPE15118BW
Personale medico



SEPE15156BW
Defibrillatore



SEPE15180BW
Punto d'incontro



SEPE15106BW
Idrante



SEPE15107BW
Estintore



SEPE15111BW
Presidio antincendio



SEPE15115BW
Lancia antincendio



SEPE15117BW
Pulsante allarme antincendio



SEPE1301BW
Vietato fumare



SEP1312BW
Vietato l'accesso



SEPE1347BW
Vietato usare l'ascensore



SEP5008BW
Area videosorvegliata



SEP15642BW
Toilette uomo



SEP15643BW
Toilette donna



SEP15644BW
Toilette uomo/donna



SEP15653BW
Toilette disabili



SEPE160B
Non usare l'ascensore



LINEA PLEXI BIFACCIALE A BANDIERA

Due supporti accoppiati in plexiglass (spessore mm 4) con angoli smussati, disponibile con i simboli raffigurati in questa pagina. Altri simboli fornibili a richiesta (richiedere preventivo). Si applica al muro con un sistema di fissaggio applicabile alla parete mediante 2 tasselli (compresi nella fornitura).

DIMENSIONI DEI PLEXI BIFACCIALI A BANDIERA

CODICE	DIMENSIONI (b x h)	VERSIONE
SEPE715.....BR	340 x 200 mm	normale
SEPE715.....BR	340 x 200 mm	folotuminescente

SI APPLICA AL MURO CON UN SISTEMA DI FISSAGGIO IN ALLUMINIO (COMPRESO NELLA FORNITURA).

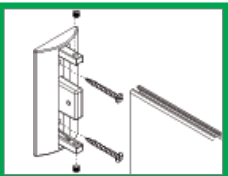

PER LA VERSIONE FOTOLUMINESCENTE DEL SEGNALE, IN FASE D'ORDINE AGGIUNGERE LA LETTERA S DOPO LA SIGLA SEP.



SEPE715101BR
Uscita emergenza sinistra



retro



SEPE715102BR
Uscita emergenza destra



retro



SEPE715103BR
Uscita emergenza avanti/alto



retro



SEPE715104BR
Uscita emergenza basso



retro



SEPE715105BR
Uscita emergenza in alto a sinistra



retro



SEPE715106BR
Uscita emergenza in alto a destra



retro



SEPE715107BR
Uscita emergenza in basso a sinistra



retro



SEPE715108BR
Uscita emergenza in basso a destra



retro

LINEA PLEXI BIFACCIALE SOSPESA

Due supporti accoppiati in plexiglass (spessore mm 4) con angoli smussati, disponibile con i simboli raffigurati in questa pagina. Altri simboli fornibili a richiesta (richiedere preventivo). Si applica al soffitto con un sistema di fissaggio applicabile al soffitto mediante 2 tasselli (compresi nella fornitura).

DIMENSIONI DEI PLEXI BIFACCIALI SOSPESI

CODICE	DIMENSIONI (b x h)	VERSIONE
SEPE715.....SR	340 x 200 mm	normale
SEPE715.....SR	340 x 200 mm	folotuminescente

SI APPLICA AL SOFFITTO CON UN SISTEMA DI FISSAGGIO IN ALLUMINIO (COMPRESO NELLA FORNITURA).

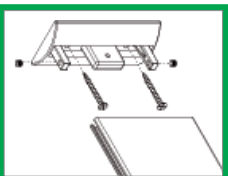

PER LA VERSIONE FOTOLUMINESCENTE DEL SEGNALE, IN FASE D'ORDINE AGGIUNGERE LA LETTERA S DOPO LA SIGLA SEP.



SEPE715101SR
Uscita emergenza sinistra



retro



SEPE715103SR
Uscita emergenza avanti/alto



retro



SEPE715104SR
Uscita emergenza basso

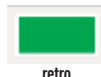

retro



SEPE715105SR
Uscita emergenza in alto a sinistra



retro



SEPE715107SR
Uscita emergenza in basso a sinistra



retro

CRISTAL

SEGNALETICA IN VETRO TEMPERATO

Sistema di segnaletica di sicurezza costituito da un supporto (versioni monofacciale e per planimetrie) o due supporti (versioni bifacciale e sospesa a bandiera) in vetro temperato spessore 4 mm. Disponibile in versione monofacciale, bifacciale, sospesa e per planimetrie. Le versioni monofacciale, bifacciale e sospesa sono disponibili con i più comuni pittogrammi. Forniti con i relativi sistemi di fissaggio.



LINEA CRYSTAL VERSIONE PER PLANIMETRIE

Segnaletica moderna e raffinata composta da 1 targa in elegante vetro temperato di sicurezza. A differenza del vetro normale, il vetro temperato viene sottoposto a un trattamento termico a circa 700° C. Questa procedura aumenta la resistenza della lastra alle sollecitazioni meccaniche (urti) e agli shock termici. Il vetro temperato viene anche chiamato vetro di sicurezza perché, nel momento in cui dovesse rompersi, si frammenta in piccolissimi pezzi levigati che non rappresentano un pericolo per le persone. La planimetria viene stampata direttamente sul retro della targa. L'intera planimetria si fissa al muro con un sistema invisibile e semplice che si applica alla parete con viti comprese nella fornitura (distanza dal muro mm 10). Utilizzo verticale o orizzontale.

DIMENSIONI DELLE PLANIMETRIE CRYSTAL

CODICE	DIMENSIONI (b x h)	CARATTERISTICHE
SECPF	300 x 450 mm	Solo cornice (grafica esclusa) per fogli formato A3
SECPFT	300 x 450 mm	Cornice comprensiva di grafica formato A3 (occorre fornire il file esecutivo di stampa)

A RICHIESTA È FORNIBILE LA VOSTRA PLANIMETRIA RIELABORATA SECONDO LA NORMA UNI ISO 23601:2009 (RICHIEDERE PREVENTIVO).

SI APPLICA AL MURO CON UN SISTEMA DI FISSAGGIO INVISIBILE (COMPRESO NELLA FORNITURA).





LINEA CRYSTAL MONOFACCIALE

Sistema di segnaletica costituito da un supporto in vetro temperato (spessore mm 4), disponibile con i simboli raffigurati in questa pagina. Altri simboli fornibili a richiesta (richiedere preventivo). Si fissa al muro con un sistema invisibile e semplice che si applica alla parete con viti comprese nella fornitura (distanza dal muro mm 10).

DIMENSIONI DEI CRYSTAL MONOFACCIALI

CODICE **DIMENSIONI (b x h)**

SECET..A 150 x 150 mm

SECET..B 200 x 200 mm

SECET..C 300 x 150 mm

SECET..D 400 x 200 mm

SI APPLICA AL MURO
CON UN SISTEMA DI
FISSAGGIO INVISIBILE
(COMPRESO NELLA
FORNITURA).



LE FRECCE SUPPLEMENTARI SONO DA
UTILIZZARSI UNICAMENTE ABBINATE
AI SEGNALE DI EMERGENZA PER DARE
L'INFORMAZIONE SULLA DIREZIONE.



**CODICE DEL
CARTELLO** **FORMATI
DISPONIBILI**



SECET1 **A B**
Pronto soccorso



SECET32 **A B**
Emergenza sinistra



SECET33 **A B**
Emergenza destra



SECET5 **A B**
Freccia destra



SECET6 **A B**
Freccia sinistra



SECET7 **A B**
Freccia avanti / alto



SECET8 **A B**
Freccia basso



SECET27 **A B**
Freccia in basso a sinistra



SECET28 **A B**
Freccia in basso a destra



SECET30 **A B**
Freccia in alto a destra



SECET31 **A B**
Freccia in alto a sinistra



SECET26 **A B**
Punto d'incontro



SECET11 **A B**
Estintore



SECET13 **A B**
Lancia antincendio



SECET14 **A B**
Pulsante allarme
antincendio



SECET15 **A B**
Idrante



SECET16 **A B**
Vietato fumare



SECET17 **A B**
Vietato l'accesso



SECET18 **A B**
Vietato usare l'ascensore



SECET19 **A B**
Vietato il passaggio
ai pedoni



SECET20 **A B**
Toilette uomo



SECET21 **A B**
Toilette uomo/donna

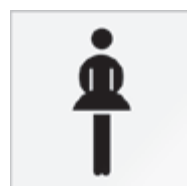

SECET22 **A B**
Toilette donna



SECET34 **A B**
Toilette disabili



SECET23 **C D**
Uscita emergenza basso



SECET32 **C D**
Uscita emergenza avanti/alto



SECET24 **C D**
Uscita emergenza destra



SECET25 **C D**
Uscita emergenza sinistra



SECET28 **C D**
Uscita emergenza
in basso a destra



SECET29 **C D**
Uscita emergenza
in basso a sinistra



SECET30 **C D**
Uscita emergenza
in alto a destra



SECET31 **C D**
Uscita emergenza
in alto a sinistra



LINEA CRYSTAL BIFACCIALE A BANDIERA

Sistema di segnaletica costituito da due supporti accoppiati in vetro temperato (spessore mm 4) con angoli smussati, disponibile con i più comuni simboli raffigurati in questa pagina. Altri simboli fornibili a richiesta (richiedere preventivo). Si applica al muro con un sistema di fissaggio applicabile alla parete mediante 2 tasselli (compresi nella fornitura).

SI APPLICA AL MURO CON UN SISTEMA DI FISSAGGIO A VITE (COMPRESO NELLA FORNITURA).

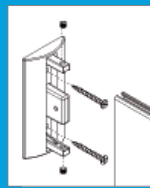

LE FRECCE SUPPLEMENTARI SONO DA UTILIZZARSI UNICAMENTE ABBINATE AI SEGNALE DI EMERGENZA PER DARE L'INFORMAZIONE SULLA DIREZIONE.



DIMENSIONI DEI CRYSTAL BIFACCIALI A BANDIERA

CODICE	DIMENSIONI (b x h)
SECT..BA	150 x 150 mm
SECT..BB	200 x 200 mm



SECTE1
Pronto soccorso

BA BB



SECT32
Emergenza sinistra

BA BB



SECT33
Emergenza sinistra

BA BB



SECT15
Freccia destra

BA BB



SECT16
Freccia sinistra

BA BB



SECT27
Freccia in basso a sinistra

BA BB



SECT26
Punto d'incontro

BA BB



SECT11
Estintore

BA BB



SECT13
Lancia antincendio

BA BB



SECT14
Pulsante allarme antincendio

BA BB



SECT15
Idrante

BA BB



SECT16
Vietato fumare

BA BB



SECT17
Vietato l'accesso

BA BB



SECT18
Vietato usare l'ascensore

BA BB



SECT19
Vietato il passaggio ai pedoni

BA BB



SECT20
Toilette uomo

BA BB



SECT21
Toilette uomo/donna

BA BB



SECT22
Toilette donna

BA BB



SECT34
Toilette disabili

BA BB



LINEA CRYSTAL BIFACCIALE A BANDIERA

Sistema di segnaletica costituito da due supporti accoppiati in vetro temperato (spessore mm 4) con angoli smussati, disponibile con i simboli raffigurati in questa pagina. Altri simboli fornibili a richiesta (richiedere preventivo). Si applica al muro con un sistema di fissaggio applicabile alla parete mediante 2 tasselli (compresi nella fornitura).

DIMENSIONI DEI CRYSTAL BIFACCIALI A BANDIERA

CODICE DIMENSIONI (b x h)

SECET..BC 300 x 150 mm

SECET..BD 400 x 200 mm

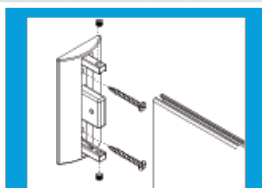

SI APPLICA AL MURO CON UN SISTEMA DI FISSAGGIO A VITE (COMPRESO NELLA FORNITURA).

L'ATTACCO È PREVISTO SEMPRE A SINISTRA!



SECET23 BC BD

Uscita emergenza basso

retro



SECET32 BC BD

Uscita emergenza avanti / alto

retro



SECET24 BC BD

Uscita emergenza destra

retro



SECET25 BC BD

Uscita emergenza sinistra

retro



SECET28 BC BD

Uscita emergenza in basso a destra

retro



SECET29 BC BD

Uscita emergenza in basso a sinistra

retro



SECET30 BC BD

Uscita emergenza in alto a destra

retro



SECET31 BC BD

Uscita emergenza in alto a sinistra

retro

LINEA CRYSTAL BIFACCIALE SOSPESA

Sistema di segnaletica costituito da due supporti accoppiati in vetro temperato (spessore mm 4) con angoli smussati, disponibile con i simboli raffigurati in questa pagina. Altri simboli fornibili a richiesta (richiedere preventivo). Si applica al soffitto con un sistema di fissaggio applicabile al soffitto mediante 2 tasselli (compresi nella fornitura).

DIMENSIONI DEI CRYSTAL BIFACCIALI A BANDIERA

CODICE DIMENSIONI (b x h)

SECET..SC 300 x 150 mm

SECET..SD 400 x 200 mm

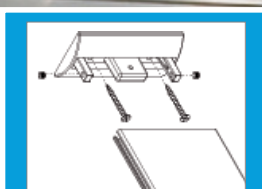

SI APPLICA AL SOFFITTO CON UN SISTEMA DI FISSAGGIO A VITE (COMPRESO NELLA FORNITURA).



SECET23 SC SD

Uscita emergenza basso

retro



SECET32 SC SD

Uscita emergenza avanti / alto

retro



SECET24 SC SD

Uscita emergenza destra

retro



SECET28 SC SD

Uscita emergenza in basso a destra

retro



SECET30 SC SD

Uscita emergenza in alto a destra

retro

METAL

SEGNALETICA IN ALLUMINIO

METAL: VERSIONE CON PROFILI IN PVC COLORATO

Sistema di segnaletica di sicurezza discreto ed elegante con cornice smussata spessore mm 4, proposto nella **versione in alluminio con profili in PVC colorati**. Pannello anteriore spessore mm 1,2, disponibile con i più comuni pittogrammi, in versione monofacciale, bifacciale a bandiera e bifacciale sospesa. Fornito con i relativi sistemi di fissaggio (viti e tasselli).



- PITTGRAMMA DI EMERGENZA - CORNICE VERDE (RAL 6024)
- PITTGRAMMA ANTINCENDIO - CORNICE ROSSA (RAL 3020)
- PITTGRAMMA DI INFORMAZIONE - CORNICE GRIGIA (RAL 7016)



VERSIONE CON PROFILI IN PVC COLORATO.



METAL: VERSIONE IN ALLUMINIO ANODIZZATO

Sistema di segnaletica di sicurezza discreto ed elegante con cornice smussata spessore mm 4, proposto nella **versione in alluminio anodizzato con angoli in metallo pressofuso colore argento**. Pannello anteriore spessore mm 1,2 disponibile con i più comuni pittogrammi, in versione monofacciale, bifacciale a bandiera e bifacciale sospesa. Fornito con i relativi sistemi di fissaggio (viti e tasselli).



VERSIONE IN ALLUMINIO ANODIZZATO.





LINEA METAL MONOFACCIALE IN ALLUMINIO ANODIZZATO

Sistema di segnaletica costituito da un supporto in alluminio anodizzato con angoli in metallo pressofuso colore argento. Disponibile con i simboli raffigurati in questa pagina. Altri simboli fornibili a richiesta (richiedere preventivo). Si fissa al muro tramite due tasselli e due viti compresi nella fornitura.



SI APPLICA AL MURO
TRAMITE VITI E TASSELLI
(COMPRESI NELLA FORNITURA).

DIMENSIONI DEI METAL MONOFACCIALI

CODICE	DIMENSIONI (b x h)	VERSIONE
SEM....A	148 x 148 mm	normale
SEML....A	148 x 148 mm	fololuminescente
SEM....G	210 x 210 mm	normale
SEML....G	210 x 210 mm	fololuminescente
SEME715...N	300 x 148 mm	normale
SEMLE715...N	300 x 148 mm	fololuminescente
SEME715...M	420 x 210 mm	normale
SEMLE715...M	420 x 210 mm	fololuminescente

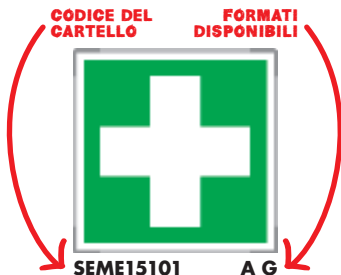

SEM15101 A G
Pronto soccorso



SEM15118 A G
Personale medico



SEM15156 A G
Defibrillatore



SEM15180 A G
Punto d'incontro



SEM15106 A G
Idrante



SEM15107 A G
Estintore



SEM15111 A G
Presidio antincendio



SEM15115 A G
Lancia antincendio



SEM15117 A G
Pulsante allarme antincendio



SEM1301 A G
Vietato fumare



SEM1312 A G
Vietato l'accesso



SEM1347 A G
Vietato usare l'ascensore



SEM5008 A G
Area videosorvegliata



SEM15642 A G
Toilette uomo



SEM15643 A G
Toilette donna



SEM15644 A G
Toilette uomo/donna



SEM15653 A G
Toilette disabili



SEM715101 N M
Uscita emergenza sinistra



SEM715102 N M
Uscita emergenza destra



SEM715103 N M
Uscita emergenza avanti/alto



SEM715104 N M
Uscita emergenza basso



SEM715105 N M
Uscita emergenza in alto a sinistra



SEM715106 N M
Uscita emergenza in alto a destra



SEM715107 N M
Uscita emergenza in basso a sinistra



SEM715108 N M
Uscita emergenza in basso a destra



LINEA METAL MONOFACCIALE CON PROFILI IN PVC COLORATO

Sistema di segnaletica costituito da un supporto in alluminio anodizzato con profili in PVC colorato, disponibile con i simboli raffigurati in questa pagina. Altri simboli fornibili a richiesta (richiedere preventivo). Si fissa al muro tramite due tasselli e due viti compresi nella fornitura.



SI APPLICA AL MURO TRAMITE VITI E TASSELLI (COMPRESI NELLA FORNITURA).

DIMENSIONI DEI METAL MONOFACCIALI

CODICE	DIMENSIONI (b x h)	VERSIONE
SEM....AC	148 x 148 mm	normale
SEML....AC	148 x 148 mm	fololuminescente
SEM....GC	210 x 210 mm	normale
SEML....GC	210 x 210 mm	fololuminescente
SEME715...NC	300 x 148 mm	normale
SEMLE715...NC	300 x 148 mm	fololuminescente
SEME715...MC	420 x 210 mm	normale
SEMLE715...MC	420 x 210 mm	fololuminescente

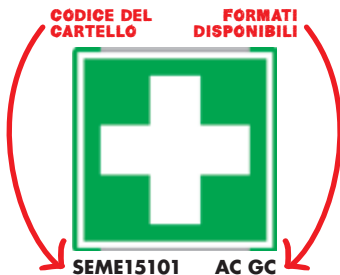

CODICE DEL CARTELLO

FORMATI DISPONIBILI



SEME15101 AC GC
Pronto soccorso



SEME15118 AC GC
Personale medico



SEME15156 AC GC
Defibrillatore



SEME15180 AC GC
Punto d'incontro



SEME15106 AC GC
Idrante



SEME15107 AC GC
Estintore



SEME15111 AC GC
Presidio antincendio



SEME15115 AC GC
Lancia antincendio



SEME15117 AC GC
Pulsante allarme antincendio



SEME1301 AC GC
Vietato fumare



SEM1312 AC GC
Vietato l'accesso



SEME1347 AC GC
Vietato usare l'ascensore



SEM5008 AC GC
Area videosorvegliata



SEM15642 AC GC
Toilette uomo



SEM15643 AC GC
Toilette donna



SEM15644 AC GC
Toilette uomo/donna



SEM15653 AC GC
Toilette disabili



SEME715101 NC MC
Uscita emergenza sinistra



SEME715102 NC MC
Uscita emergenza destra



SEME715103 NC MC
Uscita emergenza avanti/alto



SEME715104 NC MC
Uscita emergenza basso



SEME715105 NC MC
Uscita emergenza in alto a sinistra



SEME715106 NC MC
Uscita emergenza in alto a destra



SEME715107 NC MC
Uscita emergenza in basso a sinistra



SEME715108 NC MC
Uscita emergenza in basso a destra



LINEA METAL BIFACCIALE A BANDIERA IN ALLUMINIO ANODIZZATO

Sistema di segnaletica costituito da due cornici smussate (spessore mm 4) in alluminio anodizzato con angoli in metallo pressofuso colore argento. Disponibile con i simboli raffigurati in questa pagina. Altri simboli fornibili a richiesta (richiedere preventivo).

DIMENSIONI DEI METAL BIFACCIALI A BANDIERA

CODICE	DIMENSIONI (b x h)	VERSIONE
SEM....BA	148 x 148 mm	normale
SEML....BA	148 x 148 mm	fotoluminescente
SEM....BG	210 x 210 mm	normale
SEML....BG	210 x 210 mm	fotoluminescente
SEME715...BN	300 x 148 mm	normale
SEMLE715...BN	300 x 148 mm	fotoluminescente



MATERIALI PER IL FISSAGGIO COMPRESI NELLA FORNITURA (TRANNE CHIAVE COD. SEMKEY).

COD. SEMKEY - CHIAVE A BRUGOLA NECESSARIA PER IL FISSAGGIO DEL SEGNALE BIFACCIALE (DA ORDINARE SEPARATAMENTE).



SEME15101 BA BG
Pronto soccorso



SEME15118 BA BG
Personale medico



SEME15156 BA BG
Defibrillatore



SEME15180 BA BG
Punto d'incontro



SEME15106 BA BG
Idrante



SEME15107 BA BG
Estintore



SEME15111 BA BG
Presidio antincendio



SEME15115 BA BG
Lancia antincendio



SEME15117 BA BG
Pulsante allarme antincendio



SEME1301 BA BG
Vietato fumare



SEM1312 BA BG
Vietato l'accesso



SEME1347 BA BG
Vietato usare l'ascensore



SEM5008 BA BG
Area videosorvegliata



SEM15642 BA BG
Toilette uomo



SEM15643 BA BG
Toilette donna



SEM15644 BA BG
Toilette uomo/donna



SEM15653 BA BWG
Toilette disabili



SEME715101 BN
Uscita emergenza sinistra
retro



SEME715102 BN
Uscita emergenza destra
retro



SEME715103 BN
Uscita emergenza avanti/alto
retro



SEME715104 BN
Uscita emergenza basso
retro



SEME715105 BN
Uscita emergenza in alto a sinistra
retro



SEME715106 BN
Uscita emergenza in alto a destra
retro



SEME715107 BN
Uscita emergenza in basso a sinistra
retro



SEME715108 BN
Uscita emergenza in basso a destra
retro



LINEA METAL BIFACCIALE A BANDIERA CON PROFILI IN PVC COLORATO

Sistema di segnaletica da due cornici smussate (spessore mm 4) in alluminio anodizzato con profili in PVC colorato, disponibile con i simboli raffigurati in questa pagina. Altri simboli fornibili a richiesta (richiedere preventivo).

DIMENSIONI DEI METAL BIFACCIALI A BANDIERA

CODICE	DIMENSIONI (b x h)	VERSIONE
SEM....BAC	148 x 148 mm	normale
SEML....BAC	148 x 148 mm	fotoluminescente
SEM....BGC	210 x 210 mm	normale
SEML....BGC	210 x 210 mm	fotoluminescente
SEME715...BNC	300 x 148 mm	normale
SEMLE715...BNC	300 x 148 mm	fotoluminescente



MATERIALI PER IL FISSAGGIO COMPRESI NELLA FORNITURA (TRANNE CHIAVE COD. SEMKEY).

COD. SEMKEY - CHIAVE A BRUGOLA NECESSARIA PER IL FISSAGGIO DEL SEGNALE BIFACCIALE (DA ORDINARE SEPARATAMENTE).

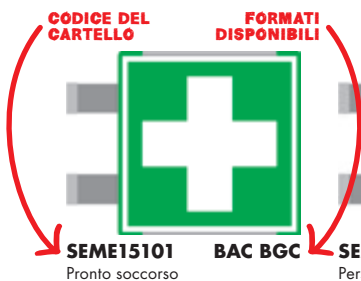

SEM15101 BAC BGC
Pronto soccorso



SEM15118 BAC BGC
Personale medico

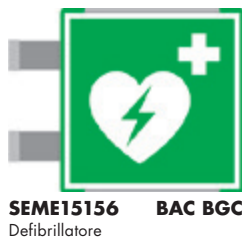

SEM15156 BAC BGC
Defibrillatore



SEM15180 BAC BGC
Punto d'incontro



SEM15106 BAC BGC
Idrante



SEM15107 BAC BGC
Estintore



SEM15111 BAC BGC
Presidio antincendio



SEM15115 BAC BGC
Lancia antincendio



SEM15117 BAC BGC
Pulsante allarme antincendio



SEM1301 BAC BGC
Vietato fumare



SEM1312 BAC BGC
Vietato l'accesso



SEM1347 BAC BGC
Vietato usare l'ascensore



SEM5008 BAC BGC
Area videosorvegliata



SEM15642 BAC BGC
Toilette uomo

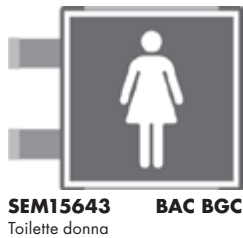

SEM15643 BAC BGC
Toilette donna

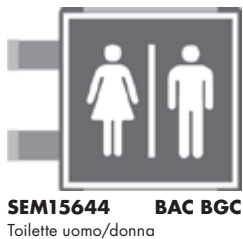

SEM15644 BAC BGC
Toilette uomo/donna



SEM15653 BAC BGC
Toilette disabili



SEM715101 BNC
Uscita emergenza sinistra
retro



SEM715102 BNC
Uscita emergenza destra
retro

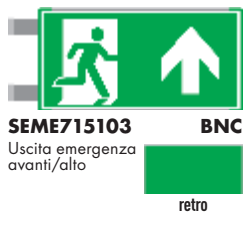

SEM715103 BNC
Uscita emergenza avanti/alto
retro

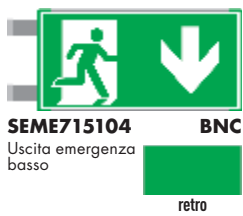

SEM715104 BNC
Uscita emergenza basso
retro



SEM715105 BNC
Uscita emergenza in alto a sinistra
retro



SEM715106 BNC
Uscita emergenza in alto a destra
retro



SEM715107 BNC
Uscita emergenza in basso a sinistra
retro



SEM715108 BNC
Uscita emergenza in basso a destra
retro



LINEA METAL BIFACCIALE SOSPESA

Sistema di segnaletica di sicurezza bifacciale sospeso su cavi d'acciaio (sospensione dal soffitto variabile fino ad un massimo di 1 m di distanza), costituito da due cornici smussate (spessore mm 4) nelle versioni:

- alluminio anodizzato con angoli in metallo pressofuso colore argento.
- profili in PVC colorato.

Disponibili con i simboli raffigurati in questa pagina. Altri simboli fornibili a richiesta (richiedere preventivo).

DIMENSIONI DEI METAL BIFACCIALI A BANDIERA		
CODICE	DIMENSIONI (b x h)	VERSIONE
SEME715....SN - SNC	300 x 148 mm	normale
SEMLE715....SN - SNC	300 x 148 mm	fotoluminescente
SEME715....SM - SMC	420 x 210 mm	normale
SEMLE715....SM - SMC	420 x 210 mm	fotoluminescente



 SEME715101 SN SM Uscita emergenza sinistra retro	 SEME715103 SN SM Uscita emergenza avanti/alto retro	 SEME715104 SN SM Uscita emergenza basso retro	 SEME715105 SN SM Uscita emergenza in alto a sinistra retro	 SEME715107 SN SM Uscita emergenza in basso a sinistra retro
 SEME715101 SNC SMC Uscita emergenza sinistra retro	 SEME715103 SNC SMC Uscita emergenza avanti/alto retro	 SEME715104 SNC SMC Uscita emergenza basso retro	 SEME715105 SNC SMC Uscita emergenza in alto a sinistra retro	 SEME715107 SNC SMC Uscita emergenza in basso a sinistra retro

LINEA METAL VERSIONE PER PLANIMETRIE

Targa singola in alluminio anodizzato per planimetrie, dimensioni 420 x 297 mm. Il materiale per il montaggio (viti e tasselli) è compreso nella fornitura. I codici SEMP e SEMPC non includono la stampa, mentre con i codici SEMPST e SEMPCST (stampa inclusa) occorre fornire il file esecutivo di stampa. Utilizzo verticale o orizzontale.

DIMENSIONI DELLE PLANIMETRIE METAL		
CODICE	CORNICE	STAMPA GRAFICA
SEMP	Alluminio anodizzato	Esclusa
SEMPST	Alluminio anodizzato	Inclusa
SEMPC	Profilo PVC colore verde	Esclusa
SEMPCST	Profilo PVC colore verde	Inclusa



SI APPLICA AL MURO TRAMITE VITI E TASSELLI (COMPRESI NELLA FORNITURA).

TARGHE FORNIBILI IN DUE VERSIONI (IN ALLUMINIO ANODIZZATO E CON PROFILI IN PVC COLORE VERDE) CON O SENZA STAMPA. CONTATTACI PER ULTERIORI INFORMAZIONI.

! A RICHIESTA È FORNIBILE LA VOSTRA PLANIMETRIA RIELABORATA SECONDO LA NORMA UNI ISO 23601:2009 (RICHIEDERE PREVENTIVO).

COLORFIX

SEGNALETICA CON FISSAGGIO COLORATO

Sistema di segnaletica di sicurezza colorato, adatto ad ogni ambiente. Composto dal cartello in alluminio 1 mm e dal sostegno di fissaggio in plastica colorato:

- verde (RAL 6024) per la segnaletica di emergenza
- rosso (RAL 3020) per la segnaletica antincendio
- grigio (RAL 7035) per la segnaletica d'informazione

Sistema disponibile in versione monofacciale, bifacciale a bandiera e bifacciale sospesa. Sostegno di fissaggio personalizzabile (richiedi preventivo).

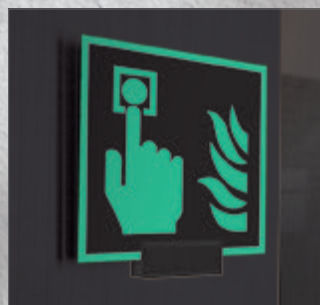

LINEA COLORFIX VERSIONE PER PLANIMETRIE

Linea di segnaletica per planimetrie con supporto colorato (verde RAL 6024). Il sistema di fissaggio a muro (viti e tasselli) è incluso nella fornitura. Formato A3 (297 x 420 mm). Per utilizzo verticale o orizzontale.

SICEP - targa murale Colorfix in alluminio 297 x 420 mm con sostegno in plastica colorato verde (grafica esclusa)

SICEPST - targa murale Colorfix in alluminio 297 x 420 mm con sostegno in plastica colorato verde, **comprensiva di grafica** (occorre fornire il file esecutivo di stampa)

DIMENSIONI DELLE PLANIMETRIE COLORFIX

CODICE	DIMENSIONI (b x h)	CARATTERISTICHE
SICEP	297 x 420 mm	Solo cornice (grafica esclusa) per fogli formato A3
SICEPST	297 x 420 mm	Cornice comprensiva di grafica formato A3 (occorre fornire il file esecutivo di stampa)

A RICHIESTA È FORNIBILE LA VOSTRA PLANIMETRIA RIELABORATA SECONDO LA NORMA UNI ISO 23601:2009 (RICHIEDERE PREVENTIVO).

SI APPLICA AL MURO CON UN SISTEMA DI FISSAGGIO INVISIBILE (COMPRESO NELLA FORNITURA).

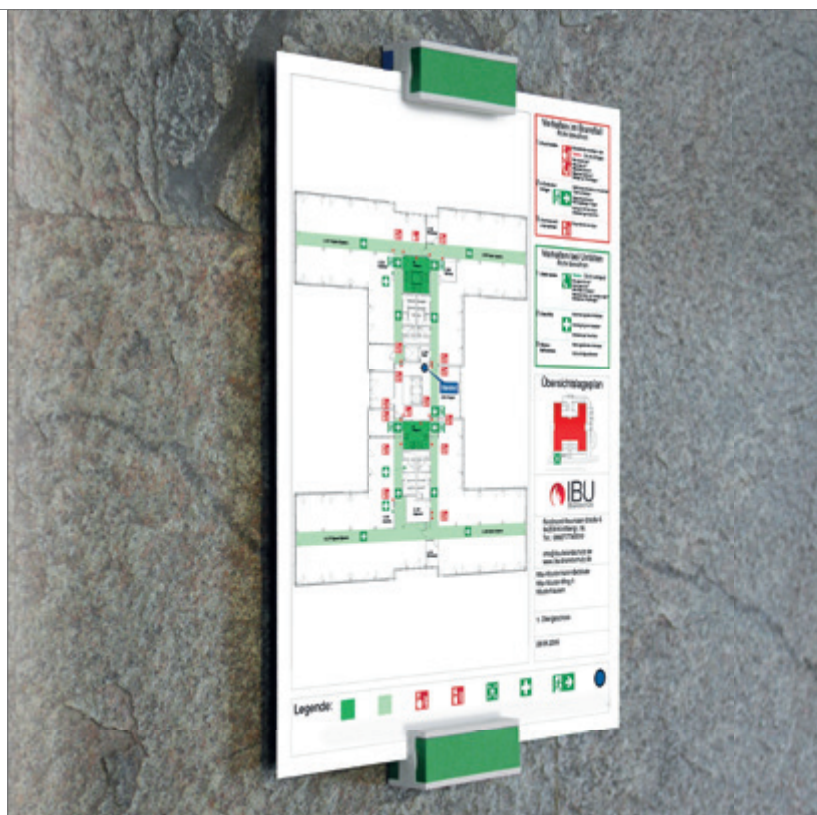



LINEA COLORFIX MONOFACCIALE

Sistema composto da un cartello in alluminio con supporto di fissaggio colorato:

- verde (RAL 6024) per la segnaletica di emergenza
 - rosso (RAL 3020) per la segnaletica antincendio
 - grigio (RAL 7035) per la segnaletica d'informazione
- Sistema di fissaggio (viti e tasselli) incluso nella fornitura.

IL CARTELLO SI FISSA NEL SUPPORTO TRAMITE VITE SENZA TESTA E BRUGOLA.



PER LA VERSIONE FOTOLUMINESCENTE DEL SEGNALE, IN FASE D'ORDINE AGGIUNGERE "L" DOPO LA SIGLA SIC (ES. SICL15117A).

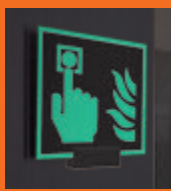

DIMENSIONI DEI COLORFIX MONOFACCIALI

CODICE	DIMENSIONI (b x h)
SICE...A	148 x 148 mm
SICE...G	210 x 210 mm
SICE715...N	300 x 148 mm
SICE715...M	420 x 210 mm



 SICE15101 A G Pronto soccorso	 SICE15118 A G Personale medico	 SICE15156 A G Defibrillatore	 SICE15180 A G Punto d'incontro	 SICE15106 A G Idrante	 SICE15107 A G Estintore
 SICE15111 A G Presidio antincendio	 SICE15115 A G Lancia antincendio	 SICE15117 A G Pulsante allarme antincendio	 SICE1301 A G Vietato fumare	 SIC1312 A G Vietato l'accesso	 SICE1347 A G Vietato usare l'ascensore
 SIC5008 A G Area videosorvegliata	 SIC15642 A G Toilette uomo	 SIC15643 A G Toilette donna	 SIC15644 A G Toilette uomo/donna	 SIC15653 A G Toilette disabili	
 SICE715101 N M Uscita emergenza sinistra	 SICE715102 N M Uscita emergenza destra	 SICE715103 N M Uscita emergenza avanti/alto	 SICE715104 N M Uscita emergenza basso		
 SICE715105 N M Uscita emergenza in alto a sinistra	 SICE715106 N M Uscita emergenza in alto a destra	 SICE715107 N M Uscita emergenza in basso a sinistra	 SICE715108 N M Uscita emergenza in basso a destra		



LINEA COLORFIX BIFACCIALE A BANDIERA O SOSPESA

Sistema composto da due cartelli in alluminio con supporto di fissaggio colorato:

- verde (RAL 6024) per la segnaletica di emergenza
- rosso (RAL 3020) per la segnaletica antincendio
- grigio (RAL 7035) per la segnaletica d'informazione

Sistema di fissaggio (viti e tasselli) incluso nella fornitura.

DIMENSIONI DEI COLORFIX BIFACCIALI

CODICE	DIMENSIONI (b x h)
SICE...BA	148 x 148 mm
SICE...BG	210 x 210 mm
SICE715...BN - SN	300 x 148 mm
SICE715...SM	420 x 210 mm

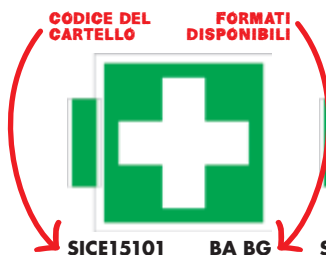

SICE15101 BA BG
Pronto soccorso

SICE15118 BA BG
Personale medico

SICE15156 BA BG
Defibrillatore

SICE15180 BA BG
Punto d'incontro

SICE715101 BN SN SM
Uscita emergenza sinistra

SICE15106 BA BG
Idrante

SICE15107 BA BG
Estintore

SICE15111 BA BG
Presidio antincendio

SICE15115 BA BG
Lancia antincendio

SICE715103 BN SN SM
Uscita emergenza avanti/alto

SICE15117 BA BG
Pulsante allarme antincendio

SICE1301 BA BG
Vietato fumare

SIC1312 BA BG
Vietato l'accesso

SICE1347 BA BG
Vietato usare l'ascensore

SICE715104 BN SN SM
Uscita emergenza basso

SIC5008 A G
Area videosorvegliata

SIC15642 A G
Toilette uomo

SIC15643 A G
Toilette donna

SIC15644 A G
Toilette uomo/donna

SICE715105 BN SN SM
Uscita emergenza in alto a sinistra

SIC15653 A G
Toilette disabili

IL CARTELLO SI FISSA NEL SUPPORTO TRAMITE VITE SENZA TESTA E BRUGOLA.

PER LA VERSIONE FOTOLUMINESCENTE DEL SEGNALE, IN FASE D'ORDINE AGGIUNGERE "L" DOPO LA SIGLA SIC (ES. SICLE715103SN).

SICE715107 BN SN SM
Uscita emergenza in basso a sinistra



Vetrofanie

LE PRIME DUE CIFRE DEL CODICE IDENTIFICANO IL FORMATO

CODICE	DIMENSIONI (b x h)	MATERIALE	PREZZO
21..S	350 x 125 mm	Pellicola autoadesiva trasparente	€ 5,40
22..S	120 x 180 mm	Pellicola autoadesiva fondo bianco	€ 4,60



2210 S



2211 S



2212 S



2213 S



2214 S



2215 S



22168 S



2218 S



2219 S



2220 S

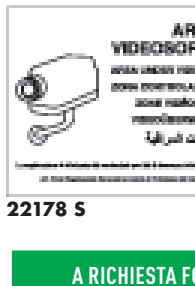

22178 S

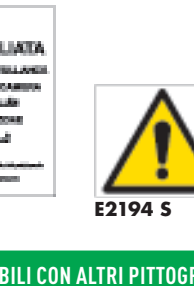

E2194 S



A RICHIESTA FORNIBILI CON ALTRI PITTOGRAMMI E SCRITTE. RICHIEDI UN PREVENTIVO.



PITTOGRAMMI DI SEGNALAZIONE PER SUPERFICI IN VETRO

Sagome di volatili, forniti su pellicola lucida adesiva, consentono di rendere più visibili le superfici trasparenti (anti-collisione per volatili). Sono colorati su entrambi i lati, visibili dall'interno e dall'esterno e applicabili sia all'interno che all'esterno. Resistenti alle condizioni atmosferiche. Minimo ordinabile 5 pezzi/multipli.

Colori disponibili: **R** rosso **N** nero

- 1 **VEU300**. - sagoma di volatile anticollisione larghezza mm 300
- 2 **VEU200**. - sagoma di volatile anticollisione larghezza mm 200
- 3 **VEU100**. - sagoma di volatile anticollisione larghezza mm 100

ALTRI MODELLI FORNIBILI A RICHIESTA. RICHIEDI UN PREVENTIVO.





ETICHETTE AUTOADESIVE DI DIVIETO, OBBLIGO E PERICOLO

DIMENSIONI DELLE ETICHETTE DI DIVIETO E OBBLIGO



A - 2 etichette per foglio



B - 4 etichette per foglio

FOR-MATO	DIMENSIONI FOGLIO	DIMENSIONI ETICHETTA	DIMENSIONI SIMBOLO	PREZZO AL FOGLIO
A	250 x 160 mm	125 x 160 mm	Ø 117 mm	€ 5,30
B	250 x 80 mm	61 x 80 mm	Ø 57 mm	€ 3,70

DIMENSIONI DELLE ETICHETTE DI PERICOLO



A - 2 etichette per foglio



B - 4 etichette per foglio

FOR-MATO	DIMENSIONI FOGLIO	DIMENSIONI LATO ETICHETTA	DIMENSIONI APPENDICE	PREZZO AL FOGLIO
A	250 x 175 mm	120 mm	120 x 33 mm	€ 5,30
B	250 x 80 mm	57 mm	57 x 16 mm	€ 3,70



E9501 A B



E9502 A B



E9503 A B



E9504 A B



E9505 A B



E9506 A B



E9507 A B



E9508 A B



E9509 A B



E9510 A B



E9512 A B



E9513 A B



E9514 A B



E9517 A B



E9529 A B



E9530 A B



E9531 A B



E9532 A B



E9544 A B



E9533 A B



E9534 A B



E9536 A B



E9537 A B



E9538 A B



E9539 A B



E9540 A B



E9541 A B



E9542 A B



E9543 A B



E9545 A B



E9546 A B



E9548 A B



E9551 A B



E9552 A B



E9553 A B



E9554 A B



 VELENO E9561 A B	 PERICOLO AMIANTO E9576 A B	 RADIOATTIVO E9555 A B	 PERICOLO ZONA CONTROLLATA E9569 A B	 PERICOLO ZONA SOFVEGLIATA E9570 A B	 PERICOLO E9557 A B
 MACCHINA AD AVVIAMENTO AUTOMATICO E9568 A B	 CARICHI SOSPESI E9558 A B	 ALTA TENSIONE E9559 A B	 CORRENTE ELETTRICA E9562 A B	 PERICOLO E9563 A B	 "spazio scrivibile" E9564 * A B
 SCARICHE ELETTRICHE E9566 A B	 ATTENZIONE ALLE MANI E9560 A B	 PERICOLO DI SCHIACCIAMENTO 9565 A B	 TEMPERATURA PERICOLOSA E9571 A B	 ATTENZIONE Rumorosità oltre 95 dB(A) 9572 A B	 ALTA TEMPERATURA 9573 A B
 ATTENZIONE ORGANI IN MOVIMENTO 9574 A B	 PERICOLO BIOLOGICO E9575 A B	 PERICOLO DI TAGLIO E9577 A B	<div style="background-color: #0070C0; color: white; padding: 5px;"> <p>i IL/I PRODOTTO/I SODDISFA/NO I REQUISITI PREVISTI DALLA DIRETTIVA EUROPEA 2002/95 (ROHS). </p> </div> <div style="background-color: #FFD700; padding: 5px; margin-top: 5px;"> <p>! ETICHETTE IN LINGUA STRANIERA A PAGINA 143.</p> </div>		

* L'articolo 9564 è in PVC autoadesivo opaco, scrivibile. È inoltre possibile applicare, nell'appendice del formato A, le etichette codice E91...B (pagine 144-145).

Etichette autoadesive non rimovibili

Etichette antimanomissione in film vinilico spalmato ultra-distruttibile, bianco lucido, senza cadmio, particolarmente adatto per la realizzazione di simboli, marcature o istruzioni di sicurezza inviolabili che devono resistere ad atti di vandalismo o di rimozione inopportuna. Tutte le etichette alle pagine 114, 115, 123, 142, 143, 144 e 145 si possono realizzare su questo supporto aggiungendo al codice la lettera "U" (esempio: U91530E). *Caratteristiche:* temperatura di applicazione minimo (+ 10°C), di servizio (- 50°C + 110°C). *Infiammabilità:* autoestinguente ISO3795.

SERIE IDEATA PER CALIBRATURA, CONTROLLI, ISPEZIONE INVENTARIO CON MEDESIME CARATTERISTICHE ANTIMANOMISSIONE. SCRIVIBILI ANCHE CON PENNA A SFERA. FORMATO ETICHETTA: MM 40 X 20. FORMATO FOGLIO: MM 200 X 40. MINIMO ORDINABILE 5 FOGLI (10 ETICHETTE PER FOGLIO)/MULTIPLI.

€ 8,60/foglio



<div style="background-color: #FFD700; padding: 5px; text-align: center;"> <p>ATTENZIONE</p> <p>spazio scrivibile</p> </div> <p>U9758</p>	<div style="background-color: #FFD700; padding: 5px; text-align: center;"> <p>TARATURA</p> <p>strumento _____ da _____ data _____ scadenza _____</p> </div> <p>U9751</p>	<div style="background-color: #0070C0; color: white; padding: 5px; text-align: center;"> <p>CALIBRATO</p> <p>data _____ da _____ scadenza _____</p> </div> <p>U9752</p>
<div style="background-color: #000000; color: white; padding: 5px; text-align: center;"> <p>INVENTARIO</p> <p>numero cespiti _____</p> </div> <p>U9753</p>	<div style="background-color: #008000; color: white; padding: 5px; text-align: center;"> <p>PROPRIETA' di</p> <p>spazio scrivibile</p> </div> <p>U9754</p>	<div style="background-color: #FF0000; color: white; padding: 5px; text-align: center;"> <p>INVENTARIO</p> <p>n. _____ conto _____ da _____ data _____</p> </div> <p>U9755</p>
<div style="background-color: #FF0000; color: white; padding: 5px; text-align: center;"> <p>SIGILLO DI GARANZIA</p> <p>La rottura di questo sigillo comporta la perdita di qualunque forma di garanzia</p> </div> <p>U9756</p>	<div style="background-color: #FF0000; color: white; padding: 5px; text-align: center;"> <p>La rottura di questo sigillo comporta la perdita di qualunque forma di garanzia</p> <p>Warranty is void if this seal is broken</p> </div> <p>U9757</p>	<div style="background-color: #008000; color: white; padding: 5px; text-align: center;"> <p>CONTROLLATO</p> <p>da _____ data _____</p> </div> <p>U9759</p>
<div style="background-color: #008000; color: white; padding: 5px; text-align: center;"> <p>C.Q. CONFORME</p> <p>da _____ data _____</p> </div> <p>U9760</p>	<div style="background-color: #000000; color: white; padding: 5px; text-align: center;"> <p>REVISIONE UNI9994-1 COLLAUDO UNI9994-1</p> <p style="font-size: 2em;">88/88</p> </div> <p>U9770</p>	<div style="background-color: #FF0000; color: white; padding: 5px; text-align: center;"> <p>ANNERIRE I SEGMENTI PER OTTENERE LA COMBINAZIONE DI NUMERI DESIDERATA. PERSONALIZZABILI A RICHIESTA (RICHIEDI UN PREVENTIVO).</p> </div>



SEGNALETICA BORDO MACCHINA IN ALLUMINIO E PVC ADESIVO

Bordo macchina in alluminio

Segnaletica bordo macchina realizzata in alluminio spessore 0,5 mm.



Bordo macchina in PVC adesivo

Segnaletica bordo macchina realizzata in PVC autoadesivo.



DIMENSIONI SEGNALI BORDO MACCHINA IN ALLUMINIO



- H - 120 x 120
- J - 115 x 115
- L - 60 x 60
- L - 60 x 60
- N - 30 x 30

CODICE	FORMATO	CONFEZIONE	PREZZO
E49...H	120 x 120 mm	25 pezzi	€ 14,40 cad.
49/E49...J	115 x 115 mm	25 pezzi	€ 5,60 cad.
E49...L	60 x 60 mm	50 pezzi	€ 7,10 cad.
49/E49...M	60 x 60 mm	50 pezzi	€ 2,60 cad.
49/E49...N	30 x 30 mm	50 pezzi	€ 2,10 cad.

DIMENSIONI SEGNALI BORDO MACCHINA IN PVC ADESIVO



MS - 5 etichette per foglio



NS - 10 etichette per foglio

CODICE	FORMATO	CONFEZIONE	PREZZO
49/E49...MS	60 x 60 mm	5 etichette per foglio	€ 6,40/foglio
49/E49...NS	30 x 30 mm	10 etichette per foglio	€ 8,60/foglio

i I CARTELLI BORDO MACCHINA IN ALLUMINIO NEI FORMATI H, J, L, M SONO PREVISTI CON GLI ANGOLI ARROTONDATI.

CODICE DEL CARTELLO FORMATI DISPONIBILI

E49601 J M N	E49602 M N	E49603 M N	E49605 M	E49607 J M N	E49608 J M	E49609 M
E49610 M N	E49611 M N	E49614 J M	E49616 J M N	E49618 M N	49620 J M N	49624 M N
E49627 M	E49631 M	49632 J M N	49634 M N	49635 M	E49636 J M	E49637 M N
E49638 J M N	E49639 J M N	49640 J M N	E49642 M N	49650 J M N	49643 M N	49644 J M



49645 M N	49646 J M N	49647 JMN	49648 JMN	49649 JMN	49651 MN	49652 JMN
49653 M N	49654 M N	49655 M	49656 JMN	49657 M	49659 JM	49663 M
49664 M	49665 M N	49666 M	49667 J M N	49668 M N	49669 M N	E49671 M N
49679 M N	49685 J M N	49686 M N	49688 M	49690 M	49692 M	49694 M
49695 M N	49696 M	49697 M N	49699 J M	E49811 M	E49821 M	E49831 M
E49701 M	E49705 M N	E49706 M N	49711 M N	49712 M N	49714 M N	E49715 M N
E49716 M	49719 M	E49721 M	49727 M N	E49728 M	E49735 M	E49736 M
E49738 N	49745 M N	4974 M N	49753 M N	49757 M	49758 M	49759 M
49760 M	49767 M	49775 M N	49778 M	E49779 M	E49851 M N	E49853 M



SEGNALETICA BORDO MACCHINA IN ALLUMINIO E PVC ADESIVO

DIMENSIONI SEGNALI BORDO MACCHINA IN ALLUMINIO

CODICE	FORMATO	CONFEZIONE	PREZZO
E49...H	120 x 120 mm	25 pezzi	€ 14,40 cad.
49/E49...J	115 x 115 mm	25 pezzi	€ 5,60 cad.
E49...L	60 x 60 mm	50 pezzi	€ 7,10 cad.
49/E49...M	60 x 60 mm	50 pezzi	€ 2,60 cad.
49/E49...N	30 x 30 mm	50 pezzi	€ 2,10 cad.

DIMENSIONI SEGNALI BORDO MACCHINA IN PVC ADESIVO

CODICE	FORMATO	CONFEZIONE	PREZZO
49/E49...MS	60 x 60 mm	5 etichette per foglio	€ 6,40/foglio
49/E49...NS	30 x 30 mm	10 etichette per foglio	€ 8,60/foglio

i I CARTELLI BORDO MACCHINA NEI FORMATI H, J, L, M SONO PREVISTI CON GLI ANGOLI ARROTONDATI.



E49854 M N	E49855 M N	E49856 M N	E49858 M	E49861 M N	E49863 M N	49870 M
E49873 M N	49874 M	49878 N	E49879 N	E49880 M N	49882 M N	49884 M N
49885 M N	49886 N	49887 M N	E49888 M N	E49890 M	49893 M N	E49899 M N
49500 M N	E49003 H L	E49004 H L	49010 M N	49011 M N	49012 M N	49013 M N
49014 M N	49015 M N	49016 M N	<div data-bbox="689 1397 1429 2058" data-label="Complex-Block"> <h3>SEGNALETICA BORDO MACCHINA PERSONALIZZATA</h3> <p>I segnali possono essere realizzati in vari materiali, con supporti specifici creati appositamente su disegno e indicazioni del cliente. È possibile inoltre avere segnali in lingue straniere (previa fornitura dei testi).</p> </div>			
49017 M N	49018 M N	49019 M N				
49020 M N	49021 M N	49022 M N				



Etichette in poliestere adesivo con lamina protettiva fornite in rotolo da 250 pezzi uguali. Resistenti all'abrasione, ai raggi UV ed ai solventi. Ottima adesione su tutte le superfici pulite ed asciutte. **Disponibili tre formati:**

- lato o diametro 25 mm
- lato o diametro 50 mm
- lato o diametro 100 mm

i AI SENSI DIN DIR. CEE 92/58.

ESEMPI DI CODIFICA

CODICE	DESCRIZIONE
NPS110125	rotolo da 250 bollini lato 25 mm
NPS110150	rotolo da 250 bollini lato 50 mm
NPS1101100	rotolo da 250 bollini lato 100 mm

! A RICHIESTA, I ROTOLI SONO FORNIBILI CON ALTRI PITTOGRAMMI.



easy fix®

**SEGNALETICA
IN ALLUMINIO CON
RETRO ADESIVO**

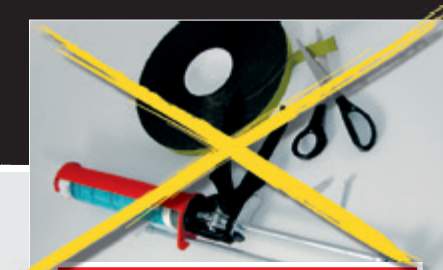

**CON EASYFIX® POTRAI DIRE ADDIO
A TUTTI I VECCHI METODI DI
APPLICAZIONE DELLA SEGNALETICA!**



**TI BASTERÀ RIMUOVERE LA
PELLICOLA PROTETTIVA GIALLA
SUL RETRO DEL CARTELLO E...**



**...APPLICARLO AL MURO O
QUALSIASI ALTRA SUPERFICIE!
E IL GIOCO È FATTO!**

Il sistema brevettato EasyFix® consente un'applicazione semplice e veloce delle principali referenze di segnaletica privata e aziendale, sviluppate su supporti in alluminio (a richiesta in plastica) con spessori da 0,2 a 3 mm. I cartelli, imbustati singolarmente e completi di istruzioni, sono pronti all'uso, realizzati con uno speciale bi-adesivo applicato sulla parte posteriore che permette un'affissione istantanea su qualsiasi superficie: muro, cemento, metallo, legno. Il prodotto EasyFix® è idoneo sia per ambienti esterni che interni e con tenuta assicurata in ogni condizione climatica (temperature comprese tra -40°C e +120°C). L'applicazione pratica richiede pochi secondi e la tenuta è immediata e definitiva, con significativo risparmio in termini di tempo e materiali.

DIMENSIONI SEGNALETICA IN ALLUMINIO EASYFIX®

CODICE	FORMATO	MATERIALE	PREZZO
EEF16133W	220 x 100 mm	Alluminio spessore 0,5 mm con retro adesivo	€ 6,90 cad.
EEF17...K	350 x 125 mm	Alluminio spessore 0,5 mm con retro adesivo	€ 8,60 cad.
EEF18...K	350 x 125 mm	Alluminio spessore 0,5 mm con retro adesivo	€ 8,90 cad.
EEF19...K	350 x 125 mm	Alluminio spessore 0,5 mm con retro adesivo	€ 8,70 cad.
EEF20...X	250 x 310 mm	Alluminio spessore 0,5 mm con retro adesivo	€ 10,60 cad.
EF3337	200 x 300 mm	Alluminio spessore 0,5 mm con retro adesivo	€ 12,00 cad.
EEF35..	300 x 200 mm	Alluminio spessore 0,5 mm con retro adesivo	€ 12,00 cad.



EEF1739K



EEF1743K



EEF1747K



EEF1760K



EEF1801K



EEF1823K



EEF1824K



EEF18089K



EEF1901K



EEF1904K



EEF1906K



EEF16133W



EEF20113X



EEF20114X



EEF20118X



EEF20150X



EEF3530



EEF3525



EEF20153X



EEF20160X



EEF20174X



EEF33378



EEF3546



EEF3554



EEF3563

i A RICHIESTA, FORNIBILI ALTRI SEGNALI SU SUPPORTO EASYFIX®.



Frecche autoadesive in PVC

Fornite in foglio distributore 340 x 60 mm e disponibili nei seguenti colori di fondo (indicare la lettera colore dopo il codice):

R rosso **G** verde **B** blu **Y** giallo
V violetto **S** grigio argento **M** marrone **A** arancio

ESEMPLI DI CODIFICA

CODICE	DESCRIZIONE	PREZZO
9390A.	1 etichetta 340 x 60 mm	€ 4,80/foglio
9390B.	2 etichette 170 x 60 mm	€ 5,00/foglio
9390C.	6 etichette 113 x 30 mm	€ 5,30/foglio
9390D.	6 etichette 113 x 30 mm	€ 5,30/foglio



9390A. - 1 etichetta 340 x 60 mm, colori vari



9390B. - 2 etichette 170 x 60 mm, colori vari



9390C. - 6 etichette 113 x 30 mm, colori vari



9390D. - 6 etichette 113 x 30 mm, colori vari



9395. € 2,80/foglio

Foglio distributore: 121 x 40 mm.
 Contiene 11 etichette 11 x 40 mm.
 Minimo ordinabile 5 fogli (55 etichette)/multipli.
 Disponibili nei colori di fondo:

R rosso **G** verde **B** blu **Y** giallo **N** nero

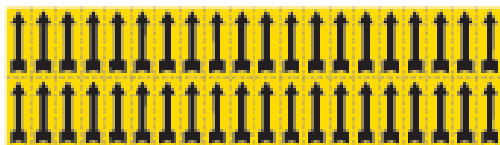

9396. € 3,70/foglio

Foglio distributore: 140 x 40 mm.
 Contiene 40 etichette 7 x 20 mm.
 Minimo ordinabile 5 fogli (200 etichette)/multipli.
 Disponibili nei colori di fondo:

R rosso **G** verde **B** blu **Y** giallo **N** nero **S** argento

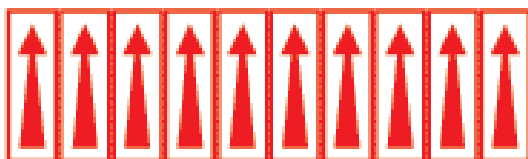

9397. € 2,80/foglio

Foglio distributore: 170 x 50 mm.
 Contiene 10 etichette 17 x 50 mm.
 Minimo ordinabile 5 fogli (50 etichette)/multipli.
 Disponibili nei colori:

R freccia rossa/fondo bianco **W** freccia bianca/fondo rosso
Y freccia gialla/fondo nero **N** freccia nera/fondo giallo



1 FRECCHE ADESIVE IN ROTOLO

Frecche adesive in rotolo (non staccabili in modulo continuo) per tubazioni, in poliestere adesivo con lamina protettiva. Ideali per completare le informazioni d'identificazione delle sostanze indicando la direzione del flusso. Resistente all'abrasione, ai raggi UV ed ai solventi. Ottima adesione su tutte le superfici pulite ed asciutte. Disponibile in 10 colori e 3 altezze: 25, 50 e 100 mm. Lunghezza rotoli m 33.

NBTF25.. - nastro per tubazioni, h mm 25, colori vari

NBTF50.. - nastro per tubazioni, h mm 50, colori vari

NBTF100.. - nastro per tubazioni, h mm 100, colori vari

Colori: **WN** bianco/nero **SN** grigio/nero **NW** nero/bianco **BW** blu/bianco
RW rosso/bianco **AN** arancio/nero **GW** verde/bianco **YN** giallo/nero
VV viola/bianco **MW** marrone/bianco



2 NASTRO AUTOADESIVO PER TUBAZIONI

Nastro per tubazioni in poliestere adesivo con lamina protettiva per l'identificazione delle sostanze mediante colore. Resistente ad agenti chimici ed atmosferici. Adatto in interno ed esterno. Buona resistenza all'abrasione. Disponibile in 10 colori e 3 altezze: 25, 50 e 100 mm. Lunghezza rotoli m 33.

NBTN25. - nastro per tubazioni, h mm 25, colori vari

NBTN50. - nastro per tubazioni, h mm 50, colori vari

NBTN100. - nastro per tubazioni, h mm 100, colori vari

Colori: **W** bianco **S** grigio **N** nero **R** rosso **Y** giallo ocra
A arancio **B** blu **G** verde **M** marrone **V** viola



Etichette autoadesive per imballi e recipienti contenenti sostanze pericolose

Etichette autoadesive per segnalare la presenza di sostanze pericolose. **Disponibili in 6 formati diversi**, pretagliate e pronte per essere applicate.

DIMENSIONI ETICHETTE AUTOADESIVE PER SOSTANZE PERICOLOSE

FORMATO	DIMENSIONI ETICHETTA	DIMENSIONI FOGLIO	N° ETICHETTE PER FOGLIO	PREZZO
A	57 x 57 mm	171 x 114 mm	6	€ 4,50/foglio
B	41 x 41 mm	164 x 123 mm	12	€ 4,50/foglio
C	29 x 29 mm	174 x 116 mm	24	€ 5,00/foglio
D	20 x 20 mm	160 x 120 mm	48	€ 5,00/foglio
E	100 x 100 mm	-	1	€ 1,64/etichetta
G	300 x 300 mm	-	1	€ 6,10/etichetta

CODICE DEL CARTELLO

FORMATI DISPONIBILI

9421 ABCDEG
GHS01 - Materiali esplosivi

9422 ABCDEG
GHS02 - Materiali infiammabili

9423 ABCDEG
GHS03 - Materiali comburenti

9424 ABCDEG
GHS04 - Gas sotto pressione

9425 ABCDEG
GHS05 - Materiali corrosivi

9426 ABCDEG
GHS06 - Tossicità acuta cat. 1, 2, 3

9427 ABCDEG
GHS07 - Tossicità acuta cat. 4
irritazione cutanea, oculare,
delle vie respiratorie, narcosi

9428 ABCDEG
GHS08 - Rischi mutageni,
respiratori, cancerogeni
o per la riproduzione

9429 ABCDEG
GHS09 - Pericolo per l'ambiente
acquatico

CLASSIFICAZIONE ED ETICHETTATURA DELLE SOSTANZE - REGOLAMENTO CE E CRITERI GHS

Simbolo	Classi e categorie di Pericolo	Indicazioni di pericolo	Consigli di prudenza

5459 - cartello elenco sostanze pericolose. Materiale: alluminio spessore 1 mm. Dimensioni 700 x 500 mm

€ 71,40

REGOLAMENTAZIONE PER L'IDENTIFICAZIONE DELLE SOSTANZE PERICOLOSE

Il GHS (Globally Harmonised System) è un sistema delle Nazioni Unite per identificare le sostanze chimiche pericolose. Adottato da molti paesi in tutto il mondo, ha lo scopo di **rendere omogenea l'identificazione delle sostanze chimiche su scala mondiale** al fine di limitare i rischi per l'uomo e l'ambiente sia durante la manipolazione sia durante lo stoccaggio e l'eliminazione di tali sostanze. Il regolamento CLP (Classification, Labelling and Packaging - classificazione, etichettatura e confezionamento) mette in pratica le raccomandazioni del sistema GHS in Europa. Il regolamento CLP è entrato in vigore il 20 gennaio 2009 e dal 1 giugno 2017, tutte le sostanze e miscele pericolose immesse nel mercato devono essere etichettate conformemente al regolamento CLP.



PRIMA



DOPO





Segnaletica per bombole

€ 5,50

Realizzate secondo la norma europea EN 1089.3 (colorazioni distintive UNI). **Dimensioni etichette:** 330 x 105 mm.

**TOSSICO E/O
CORROSIVO**

9731

INFIAMMABILE

9732

OSSIDANTE

9733

INERTE

9734

ACETILENE

9735

OSSIGENO

9736

**PROTOSSIDO
D'AZOTO**

9737

ARGO

9738

AZOTO

9739

**ANIDRIDE
CARBONICA**

9740

ELIO

9741

**DEPOSITI
BOMBOLE A GAS
A PAGINA 491.**

BOMBOLE TRASPORTABILI PER GAS IDENTIFICAZIONE DELLA BOMBOLA CODIFICAZIONE DEL COLORE - UNI EN 1089-3		
GAS e MISCELE	COLORE DISTINTIVO	ES
Gasolio compresso	GRANDE	
Inflammabile	ROSSO	
Ossidante	BLU CHIARO	
Acido	VERDE BIANCASTE	
Tossico e infiammabile	GRANDE PIU' ROSSO	
Tossico e ossidante	GRANDE PIU' BLU CHIARO	
Acidificante	MAFFICA ROSSOCASTE	
Designato	BIANCO	
Prodotto d'acido	BLU	
Argo	VERDE SCURO	
Acido	NERO	
Acido carbonico	GRANDE	
Elie	MAFFICA	
Azoto e aria atmosferica	BIANCO PIU' NERO	
Ossigeno	BIANCO PIU' MARRONE	
Ossigeno/acido carbonico	BIANCO PIU' GRIGIO	
Ossigeno/acido carbonico/ossido	BIANCO PIU' BLU	

3803

Cartello colorazioni distintive gas, dimensioni 400 x 500 mm, alluminio spessore 0,7 mm

€ 43,80



Etichette autoadesive e cartelli vari

LA LETTERA FINALE DEL CODICE IDENTIFICA IL FORMATO

CODICE	DIMENSIONI (b x h)	FOGLIO DISTRIBUTORE (b x h)	MATERIALE	MINIMO ORDINABILE	PREZZO
E49..E	120 x 70 mm	-	Alluminio spessore 0,5 mm	10 pezzi/multipli	€ 4,30
EY..49..E	120 x 70 mm	-	Alluminio spessore 0,5 mm	10 pezzi/multipli	€ 5,00
E49..F	90 x 70 mm	-	Alluminio spessore 1 mm	10 pezzi/multipli	€ 9,30
EY..49..F	90 x 70 mm	-	Alluminio spessore 1 mm	10 pezzi/multipli	€ 10,00
49...G	190 x 115 mm	-	Alluminio spessore 0,5 mm	10 pezzi/multipli	€ 8,90
E91..E	120 x 70 mm	210 x 120 mm	Pellicola autoadesiva	3 etichette/foglio	€ 3,00/foglio
EY..91..E	120 x 70 mm	210 x 120 mm	Pellicola autoadesiva	3 etichette/foglio	€ 4,50/foglio

ATTENZIONE
IMPIANTO ARIA IN PRESSIONE

Prima di iniziare qualsiasi intervento manutentivo o riparazione, È OBBLIGATORIO:

- 1) arrestare il macchinario;
- 2) scaricare la pressione dell'aria mediante apposito comando;
- 3) verificare l'eventuale depressurizzazione mediante l'apposito manometro.

E49201F

CAUTION
AIR SYSTEM IN PRESSURE

Before starting any maintenance intervention or repairing, IT'S MANDATORY:

- 1) stopping machinery;
- 2) discharging air pressure through specific control;
- 3) checking depressurizing stop through suitable pressure gauge.

EYE49201F

ATTENTION
INSTALLATION AIRE EN PRESSION

Avant de commencer quelconque intervention de maintenance ou de réparation, EST OBLIGATOIRE:

- 1) arrêter l'équipement;
- 2) décharger la pression de l'air au moyen de la spécifique vanne;
- 3) vérifier la dépressurisation au moyen de spécial manomètre.

EYF49201F

ATTENZIONE
GRUPPO PRESSURIZZATO

Prima di iniziare qualsiasi intervento manutentivo o riparazione, È OBBLIGATORIO:

- 1) arrestare il macchinario;
- 2) scaricare l'accumulatore mediante apertura del saccatore di scarico;
- 3) verificare l'eventuale depressurizzazione del saccatore di scarico.

E49202F

ATTENZIONE
SERBATOIO IN PRESSIONE

Prima di iniziare qualsiasi intervento manutentivo o riparazione, È OBBLIGATORIO:

- 1) arrestare il macchinario;
- 2) scaricare la pressione dell'aria mediante apposito comando;
- 3) verificare l'eventuale depressurizzazione mediante l'apposito manometro.

E49203F

ATTENZIONE

È VIETATO EFFETTUARE LAVORI SU APPARECCHIATURE ELETTRICHE SOTTO TENSIONE

ESSENTIAU LEBENSWEISUNG BEWAHREN AUTOMATEN BEI LEBENSWEISUNG

BEI CONDIZIONE DI PARTICOLARE PERICOLO DEVE ESSERE PRESERTE SPECIALI MISURE SOTTO A CURA DEGLI OPERAI INIZIARE I LAVORI SOLO AD AVVENUTA ATTUAZIONE DELLE MISURE DI SICUREZZA

E49530E

E91530E

ACHTUNG

STROMGERÄTE UNTERSUCHEN BEI AUSGEGLICHENEM ZUSTAND. KEINE ARBEITEN UNTER VOLLENSPANNUNG DURCHFÜHREN!

BEI BEDINGUNGEN BEWAHREN ARBEITENSICHERHEIT MÜSSEN EINZELNE PERSONEN GEWISSENDE MAßNÄHMEN VOR BEGINN DER ARBEITEN NENNEN ZUERST DIE SICHERHEITSSCHRITTMAßNAHMEN BETROFFEN WERDEN

EYD49530E

EYD91530E

WARNING

DO NOT OPERATE ON LIVE ELECTRIC EQUIPMENT

NEVER SERVICE EQUIPMENT MUST BE OBTAINED FROM THE PORTABLE AUTOMATIC

NOT LESS THAN TWO PERSONS MUST OPERATE IN SAME CONDITION

DO NOT START WORK WITHOUT HAVING PERFORMED THE NECESSARY PRECAUTIONS

EYE49530E

EYE91530E

ATTENTION

È ÈVIETATO DI TRAVELLARE SUR DES APPAREILLAGES ELECTRIQUES SOUT TENSION

ESSENTIAU LEBENSWEISUNG BEWAHREN AUTOMATEN BEI LEBENSWEISUNG

BEI CONDIZIONE DI PARTICOLARE PERICOLO DEVE ESSERE PRESERTE SPECIALI MISURE SOTTO A CURA DEGLI OPERAI INIZIARE I LAVORI SOLO AD AVVENUTA ATTUAZIONE DELLE MISURE DI SICUREZZA

EYF49530E

EYF91530E

ATENCION

SE PROHIBO ESPECTAR TRABAJOS SOBRE EQUIPOS ELECTRICOS EN TENSION

ESSENTIAU LEBENSWEISUNG BEWAHREN AUTOMATEN BEI LEBENSWEISUNG

BEI CONDIZIONE DI PARTICOLARE PERICOLO DEVE ESSERE PRESERTE SPECIALI MISURE SOTTO A CURA DEGLI OPERAI INIZIARE I LAVORI SOLO AD AVVENUTA ATTUAZIONE DELLE MISURE DI SICUREZZA

EYS49530E

EYS91530E

ATTENZIONE

Leggere attentamente il manuale. Lire consegnare nel libretto d'entrata. Carefully read Operator's Manual. Ver Inbetriebnahme die Betriebsanleitung lesen.

Se range leer el Manual con cuidado

E49537E

E91537E

ATTENZIONE

Leggere attentamente il manuale dell'operatore prima di far funzionare la macchina. Osservare le norme e le avvertenze di sicurezza durante il funzionamento.

Lire le livret d'entree avant de commencer le travail. Observer les normes de securite pendant le fonctionnement.

Caridat read Operator's Manual before starting the machine. Observe instructions and safety rules when operating.

Ver Inbetriebnahme die Betriebsanleitung und Sicherheitsvorschriften lesen und beachten.

Leer con cuidado el manual de instrucciones antes de la utilización de la máquina. Observar las normas de seguridad durante la operación de la máquina.

E49538E

E91538E

EX

**PERICOLO
ESPLOSIONE
DANGER
EXPLOSION**

49752E

MISURE DI SICUREZZA

1. LEGGERE IL MANUALE DI ISTRUZIONI accuratamente prima di mettere in marcia la macchina.
2. OSSERVARE SCRUPOLOSAMENTE tutte le istruzioni riportate sulla targhetta di avvertimento.
3. NON ESSERE MAI in macchina senza supporto di protezione. Liberarsi solo a tutti dispositivi di sicurezza.
4. NON TENTARE MAI di cambiare l'apparecchio del prodotto CNC.
5. Le macchine di serie e al nuovo sostituito. NON TOCCARE MAI le parti ruotanti o in movimento.
6. STACCARE SEMPRE LA TENSIONE prima di effettuare qualsiasi riparazione o lavoro di manutenzione sulla macchina.

IN CASO DI MANCATO RISPETTO DELLE ISTRUZIONI DI CUI SOPRA, SI POTREBBERO CAUSARE GRAVI LESIONI PERSONALI O DANNI ALLA MACCHINA.

49231G

MISURE DI SICUREZZA

1. LEGGERE IL MANUALE DI ISTRUZIONI accuratamente prima di mettere in marcia la macchina.
2. OSSERVARE SCRUPOLOSAMENTE tutte le istruzioni riportate sulla targhetta di avvertimento.
3. NON ESSERE MAI in macchina senza supporto di protezione. Liberarsi solo a tutti dispositivi di sicurezza.
4. NON TOCCARE MAI le macchine senza supporto di protezione. Liberarsi solo a tutti dispositivi di sicurezza.
5. STACCARE SEMPRE LA TENSIONE prima di effettuare qualsiasi riparazione o lavoro di manutenzione sulla macchina.

IN CASO DI MANCATO RISPETTO DELLE ISTRUZIONI DI CUI SOPRA, SI POTREBBERO CAUSARE GRAVI LESIONI PERSONALI O DANNI ALLA MACCHINA.

49232G

I IL/1 PRODOTTO/I SODDISFA/NO I REQUISITI PREVISTI DALLA DIRETTIVA EUROPEA 2002/95 (ROHS).





NUOVA SEGNALETICA PER TUBAZIONI ISO 20560-1

Conforme al nuovo standard internazionale per identificare le tubazioni (Norma ISO 20560-1). Pretagliate, realizzate in stampa digitale pellicola PVC ad alta adesività sovra laminato con pellicola anti UV. Resistenze al calore (+65°C) e al freddo (-30°C). L'applicazione deve essere effettuata ad almeno 10°C. Vengono fornite con frecce (in una singola direzione), simboli GHS e i pittogrammi di pericolo previsti.

COME COMPORRE IL CODICE

99B781N A S

Sostanza
(es. Acetone)

Lettera
formato

Direzione
freccia



A RICHIESTA
SISTEMA
WRAP
AROUND.



DIMENSIONI DELLE ETICHETTE AUTOADESIVE

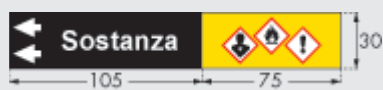

FORMATO A - 180 x 30 mm
Per tubazioni con Ø inferiore a 50 mm

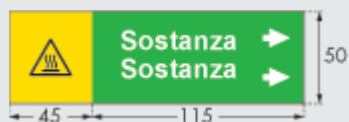

FORMATO B - 160 x 50 mm
Per tubazioni con Ø da 50 a 80 mm



FORMATO C - 165 x 70 mm
Per tubazioni con Ø da 80 a 120 mm



FORMATO D - 225 x 90 mm
Per tubazioni con Ø da 120 a 200 mm

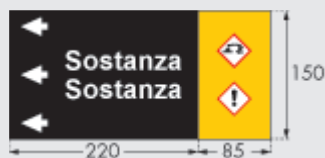

FORMATO E - 305 x 150 mm
Per tubazioni con Ø da 200 a 350 mm



FORMATO F - 450 x 210 mm
Per tubazioni con Ø superiore a 350 mm

CODICE	FORMATO	DIMENSIONI (b x h)	MINIMO ORDINABILE	PREZZO
99...N	A	180 x 30 mm *	1 foglio da 5 etichette	€ 20,23/foglio
99...N	B	160 x 50 mm *	1 foglio da 5 etichette	€ 29,92/foglio
99...N	C	165 x 70 mm *	1 foglio da 5 etichette	€ 43,18/foglio
99...N	D	255 x 90 mm *	1 foglio da 5 etichette	€ 85,85/foglio
99...N	E	305 x 150 mm *	1 etichetta	€ 34,34
99...N	F	450 x 150 mm *	1 etichetta	€ 70,72

ETICHETTE PERSONALIZZATE



Freccia Nome della sostanza Pittogrammi GHS

La scelta del colore di fondo dell'etichetta dipende dal tipo di sostanza da segnalare (es. Alkali - viola)

Il formato dipende dal diametro della tubazione sulla quale dovrà essere applicata l'etichetta (es. tubazione Ø 90 mm - etichetta formato C)

Le etichette per tubazioni CLP a norma ISO 20560-1 sono realizzabili, senza minimi quantitativi richiesti, anche su specifica richiesta dei clienti in base alle SDS (schede di sicurezza) delle sostanze da segnalare. Tali schede devono essere aggiornate al Regolamento (CE) n. 1272/2008 e riportare chiaramente i pittogrammi che il cliente vuole inserire.

CODICE	DIMENSIONI	PREZZO
CLP99...NA.	360 x 60 mm	€ 24,30/foglio
CLP99...NB.	236 x 37 mm	€ 36,00/foglio
CLP99...NC.	696 x 116 mm	€ 51,90
CLP99...ND.	696 x 230 mm	€ 103,10/foglio
CLP99...NE.	236 x 37 mm	€ 41,30
CLP99...NF.	236 x 37 mm	€ 84,90

SUPPORTI PORTAETICHETTE



Supporto portaetichette in alluminio preverniciato spessore mm 0,5, con 4 losanghe 20 x 2 mm. Si applica con fascette o regge (vedi pagina 292).

CODICE	SUPPORTO ADATTO PER
SXNETN25040	Etichette autoadesive formato A
SXNETN25060	Etichette autoadesive formato B
SXNETN25080	Etichette autoadesive formato C
SXNETN35010	Etichette autoadesive formato D
SXNETN40016	Etichette autoadesive formato E
SXNETN55022	Etichette autoadesive formato F

* In caso di sostanza non pericolosa, l'area gialla con i simboli verrà omessa: pertanto l'etichetta risulterà più stretta (es. formato A - 105 x 30 mm).



COLORI FONDO DELLE ETICHETTE AUTOADESIVE

	fondo arancio PANTONE 021C	Acidi
	fondo nero PANTONE BLACK	Liquidi e materiali solidi
	fondo grigio PANTONE 430C	Gas allo stato gassoso o liquefatto
	fondo azzurro PANTONE 2925C	Aria
	fondo verde PANTONE 362C	Acqua
	fondo viola PANTONE 258C	Alcali
	fondo rosso PANTONE 187C	Antincendio

ACQUA

(fondo verde PANTONE 362C)



99C750NBD - 160 x 50 mm

CODICE	SOSTANZA
99C710N	Acqua
99C720N	Acqua refrigerata
99C730N	Acqua addolcita
99C740N	Acqua ammoniacale
99C750N	Acqua calda
99C760N	Acqua calda sanitaria
99C770N	Acqua deionizzata
99C780N	Acqua demineralizzata
99C790N	Acqua depurata
99C800N	Acqua di circolazione
99C810N	Acqua di pozzo
99C820N	Acqua di raffreddamento
99C830N	Acqua di riscaldamento
99A670N	Acqua di torre
99C840N	Acqua distillata
99C850N	Acqua emulsionata
99C860N	Acqua fredda sanitaria
99B220N	Acqua industriale
99C870N	Acqua mare
99C880N	Acqua non potabile
99C890N	Acqua osmotizzata
99A672N	Acqua potabile

COLORE DI BASE*	SIGNIFICATO
	ACQUA
	VAPORE E ACQUA SURRISCALDATA
	GLI MINERALI VELOCI E I MINERALI LUNGI COMBUSTIBILI E INFIAMMABILI
	GLI ALI ALI STATO GASSOSO O LIQUEFATTO (ESCLUSI I VAPORI)
	ACIDI
	ALCALI
	ARIA
	ALTRI FLUIDI
	ESTINZIONE INCENDI
	COMBURENTI

3809N - cartello colorazione tubazioni in alluminio, dimensioni mm 400 x 500, a norma ISO 20560-1 **€ 43,80**

ACIDI

(fondo arancio PANTONE 021C)



99B590NFD - 450 x 210 mm

CODICE	SOSTANZA
99C020N	Acido acetico
99C030N	Acido cianidrico
99B590N	Acido cloridrico
99C040N	Acido fluoridrico
99C050N	Acido formico
99B990N	Acido fosforico
99C060N	Acido muriatico
99B620N	Acido nitrico
99C070N	Acido ossalico
99C080N	Acido perclorico
99C090N	Acido solfidrico
99B580N	Acido solforico
99C100N	Anidride acetica
99C110N	Bisolfito di sodio
99C120N	Bromo
99C130N	Cloridrina solforica
99C140N	Cloruro ferrico
99C150N	Oleum
99C160N	Policloruro di alluminio

ALCALI

(fondo viola PANTONE 258C)



99A360NCS - 165 x 70 mm

CODICE	SOSTANZA
99C900N	Cianuri
99C910N	Formaldeide
99A360N	Ipoclorito di sodio
99C920N	Latte di calce
99C930N	Mandata salamoia
99C940N	Ritorno di salamoia
99C950N	Salamoia
99A351N	Soda caustica

ANTINCENDIO

(fondo rosso PANTONE 187C)



99B212NAD - 180 x 30 mm

CODICE	SOSTANZA
99B212N	Acqua antincendio
99C700N	Vapore antincendio

GAS ALLO STATO GASSOSO O LIQUEFATTO

(fondo grigio PANTONE 430C)



99A881NAD - 180 x 30 mm

CODICE	SOSTANZA
99C540N	Acqua surriscaldata
99A662N	Condensa
99C550N	Scarico condensa
99B951N	Vapore
99C560N	Vapore alta pressione
99C570N	Vapore alta temperatura
99C580N	Vapore bassa pressione
99C590N	Vapore bar
99C600N	Vapore... °C
99C610N	Vapore pulito
99A861N	Acetilene
99B282N	Ammoniaca
99A891N	Anidride carbonica
99C630N	Anidride solforosa
99A881N	Argon
99A017N	Azoto
99C620N	Biossido di cloro
99B201N	Butano
99B980N	Cloro
99A752N	Elio
99C640N	Freon
99B751N	G.P.L.
99C650N	Gas
99C660N	Gas combustibile
99C670N	Gas promiscuo
99A113N	Idrogeno
99A231N	Metano
99C680N	Ossido di etilene
99C690N	Ossido di propilene
99A380N	Ossigeno
99A121N	Propano
99A871N	Protossido d'azoto

ARIA

(fondo azzurro PANTONE 2925C)



99A240NAS - 180 x 30 mm

CODICE	SOSTANZA
99A240N	Aria
99A241N	Aria compressa
99C960N	Aria condizionata
99C970N	Aria industriale
99C980N	Aria medica
99C990N	Aria strumentale
99D010N	Aria tecnica
99D020N	Vuoto

LIQUIDI E MATERIALI SOLIDI

(fondo nero PANTONE BLACK)

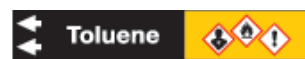

99A167NAS - 180 x 30 mm

CODICE	SOSTANZA
99C200N	Acetaldeide
99B781N	Acetone
99B523N	Acrilonitrile
99C210N	Alcool isopropilico
99C220N	Alcool
99C230N	Alcool denaturati
99C240N	Alcool di recupero
99A691N	Alcool etilico
99C250N	Alcool metilico
99C260N	Benzina
99C270N	Benzolo
99A481N	Cicloesano
99C280N	Ciclopropano
99C290N	Cloroformio
99C300N	Clorothene
99C310N	Cloruro metilene
99C320N	Dimetilsolfato
99A501N	Esano
99C330N	Esausto
99C340N	Etanolo
99C350N	Etilacetato
99B570N	Gasolio
99C360N	Glicerina
99C370N	Isobutilico
99C380N	Isopropanolo
99C390N	Isopropilico
99C400N	Kerosene
99A311N	Metanolo
99C410N	Metililchetone
99C420N	Metilisobutilchetone
99C430N	Nafta
99C440N	Olio
99C450N	Olio alta pressione
99C460N	Olio alta temperatura
99B851N	Olio combustibile
99C470N	Olio di lubrificazione
99C480N	Petrolio
99C490N	Piridina
99B241N	Solvente
99C500N	Solvente per lavaggio
99C510N	Solventi vari
99A941N	Stirolo
99A167N	Toluene
99C520N	Toluolo
99C530N	Trielina
99C170N	Cloralio
99C180N	Solfato ferroso
99C190N	Acqua ossigenata



Etichette autoadesive per tubazioni

Pretagliate, realizzate in stampa digitale su pellicola in PVC ad alta adesività, sovra laminato con pellicola anti UV. Resistenze: al calore +70°C; al freddo -35°C. **N.B. l'applicazione deve essere effettuata a temperatura di almeno 10°C.** Vengono fornite comprensive di frecce (da rimuovere a seconda della direzione del flusso) e simboli GHS.

COME COMPORRE IL CODICE

99B781 A

↓
Sostanza da segnalare
(es. Acetone - vedi elenco sostanze a pagina 127)

↓
Lettera formato



DIRETTIVA 2014/ 27/UE: SEGNALETICA DI ADEGUAMENTO AL CLP (CLASSIFICATION, LABELLING AND PACKAGING)

Questa Direttiva vuole armonizzare il regolamento (CE) n. 1272/2008 (il cosiddetto Regolamento CLP) con la direttiva del Consiglio 92/58/CEE (pre-iscrizioni minime per segnaletica di sicurezza e/o salute sul luogo di lavoro), che contiene riferimenti al precedente sistema di classificazione e di etichettatura.

DIMENSIONI DELLE ETICHETTE AUTOADESIVE



FORMATO A - 360 x 60 mm
Per tubazioni da Ø 30 a 100 mm



FORMATO B - 236 x 37 mm
Per tubazioni fino a Ø 30 mm



FORMATO C - 696 x 116 mm
Per tubazioni da Ø 100 a 150 mm



FORMATO D - 696 x 230 mm
Per tubazioni da Ø 150 a 250 mm

CODICE	FORMATO	DIMENSIONI (b x h)	MINIMO ORDINABILE	PREZZO
99...	A	360 x 60 mm	1 foglio da 5 etichette	€ 24,00/foglio
99...	B	236 x 37 mm	1 foglio da 5 etichette	€ 19,20/foglio
99...	C	696 x 116 mm	1 etichetta	€ 20,80
99...	D	696 x 230 mm	1 etichetta	€ 41,40

Freccia (da rimuovere in base alla direzione del flusso)

Nuovi pittogrammi secondo la specifica GHS

Nome della sostanza

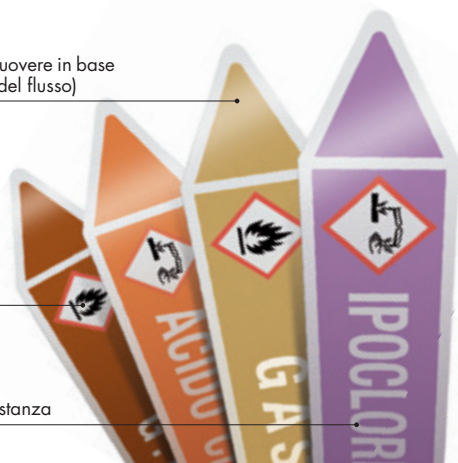

ETICHETTE PERSONALIZZATE



La scelta del colore di fondo dell'etichetta dipende dal tipo di sostanza da segnalare (es. Acidi - arancio)

Il formato dipende dal diametro della tubazione sulla quale dovrà essere applicata l'etichetta (es. tubazione Ø 110 mm - etichetta formato C)

Le etichette per tubazioni CLP a norma UNI 5634 sono realizzabili, senza minimi quantitativi richiesti, anche su specifica richiesta dei clienti in base alle SDS (schede di sicurezza) delle sostanze da segnalare. Tali schede devono essere aggiornate al Regolamento (CE) n. 1272/2008 e riportare chiaramente al punto 2.2 i pittogrammi che il cliente vuole inserire.

CODICE	DIMENSIONI	PREZZO
CLP99...A	360 x 60 mm	€ 29,00/foglio
CLP99...B	236 x 37 mm	€ 23,20/foglio
CLP99...C	696 x 116 mm	€ 25,20
CLP99...D	696 x 230 mm	€ 49,80

SUPPORTI PORTAETICHETTE



Supporto portaetichette in alluminio preverniciato spessore mm 0,5, con 4 losanghe 20 x 2 mm. Si applica con fascette o regge (vedi pagina 292).

CODICE	ADATTO PER	PREZZO
SXNET23030	Etichette formato B	€ 4,80
SXNET35050	Etichette formato A	€ 5,70
SXNET680100	Etichette formato C	€ 11,40
SXNET680200	Etichette formato D	€ 23,60



Etichette con pittogrammi GHS (solo per sostanze pericolose)

COLORI FONDO DELLE ETICHETTE AUTOADESIVE	
	fondo arancione Acidi
	fondo argento Vapore e acqua surriscaldata
	fondo azzurro Aria
	fondo marrone Olii minerali, vegetali e animali, combustibili liquidi
	fondo nero Altri liquidi
	fondo rosso Estinzione incendi
	fondo verde Acqua
	fondo giallo ocra Gas allo stato gassoso o liquefatto (esclusa l'aria)
	fondo violetto Alcali (o basici)

ACIDI

CODICE	SOSTANZA
99C050A	- 360 x 60 mm
99C020	Acido acetico
99C030	Acido cianidrico
99B590	Acido cloridrico
99C040	Acido fluoridrico
99C050	Acido formico
99B990	Acido fosforico
99C060	Acido muriatico
99B620	Acido nitrico
99C070	Acido ossalico
99C080	Acido perclorico
99C090	Acido solfidrico
99B580	Acido solforico
99C100	Anidride acetica
99C110	Bisolfito di sodio
99C120	Bromo
99C130	Cloridrina solforica
99C140	Cloruro ferrico
99C150	Oleum
99C160	Policloruro di alluminio

VAPORE-ACQUA SURRISCALDATA

CODICE	SOSTANZA
99C610B	- 236 x 37 mm
99C540	Acqua surriscaldata
99A662	Condensa
99C550	Scarico condensa
99B951	Vapore
99C560	Vapore alta pressione
99C570	Vapore alta temperatura
99C580	Vapore bassa pressione
99C590	Vapore bar
99C600	Vapore... °C
99C610	Vapore pulito

ARIA

CODICE	SOSTANZA
99A240D	- 696 x 300 mm
99A240	Aria
99A241	Aria compressa
99C960	Aria condizionata
99C970	Aria industriale
99C980	Aria medica
99C990	Aria strumentale
99D010	Aria tecnica
99D020	Vuoto

OLI MINERALI, VEGETALI, ANIMALI, COMBUSTIBILI LIQUIDI

CODICE	SOSTANZA
99A311A	- 360 x 60 mm
99C200	Acetaldeide
99B781	Acetone
99B523	Acrilonitrile
99C210	Alcool isopropilico
99C220	Alcool
99C230	Alcool denaturati
99C240	Alcool di recupero
99A691	Alcool etilico
99C250	Alcool metilico
99C260	Benzina
99C270	Benzolo
99A481	Cicloesano
99C280	Ciclopropano
99C290	Clorofornio
99C300	Clorothene
99C310	Cloruro metilene
99C320	Dimetilsolfato
99A501	Esano
99C330	Esausto
99C340	Etanolo
99C350	Etilacetato
99B570	Gasolio
99C360	Glicerina
99C370	Isobutilico
99C380	Isopropanolo
99C390	Isopropilico
99C400	Kerosene
99A311	Metanolo
99C410	Metiletilchetone
99C420	Metilisobutilchetone
99C430	Nafta
99C440	Olio
99C450	Olio alta pressione
99C460	Olio alta temperatura
99B851	Olio combustibile
99C470	Olio di lubrificazione
99C480	Petrolio
99C490	Piridina
99B241	Solvente
99C500	Solvente per lavaggio
99C510	Solventi vari
99A941	Stiolo
99A167	Toluene
99C520	Toluolo
99C530	Trielina

ALTRI LIQUIDI

CODICE	SOSTANZA
99C170B	- 236 x 37 mm
99C170	Cloralio
99C180	Solfato ferroso
99C190	Acqua ossigenata

ESTINZIONE INCENDI

CODICE	SOSTANZA
99B212A	- 360 x 60 mm
99B212	Acqua antincendio
99C700	Vapore antincendio

ACQUA

CODICE	SOSTANZA
99C800A	- 360 x 60 mm
99C710	Acqua
99C720	Acqua refrigerata
99C730	Acqua addolcita
99C740	Acqua ammoniacale
99C750	Acqua calda
99C760	Acqua calda sanitaria
99C770	Acqua deionizzata
99C780	Acqua demineralizzata
99C790	Acqua depurata
99C800	Acqua di circolazione
99C810	Acqua di pozzo
99C820	Acqua di raffreddamento
99C830	Acqua di riscaldamento
99A670	Acqua di torre
99C840	Acqua distillata
99C850	Acqua emulsionata
99C860	Acqua fredda sanitaria
99B220	Acqua industriale
99C870	Acqua mare
99C880	Acqua non potabile
99C890	Acqua osmotizzata
99A672	Acqua potabile

GAS ALLO STATO GASSOSO O LIQUEFATTO (ARIA ESCLUSA)

CODICE	SOSTANZA
99A017A	- 360 x 60 mm
99A861	Acetilene
99B282	Ammoniaca
99A891	Anidride carbonica
99C630	Anidride solforosa
99A881	Argon
99A017	Azoto
99C620	Biossido di cloro
99B201	Butano
99B980	Cloro
99A752	Elio
99C640	Freon
99B751	G.P.L.
99C650	Gas
99C660	Gas combustibile
99C670	Gas promiscuo
99A113	Idrogeno
99A231	Metano
99C680	Ossido di etilene
99C690	Ossido di propilene
99A380	Ossigeno
99A121	Propano
99A871	Protossido d'azoto

ALCALI (O BASICI)

CODICE	SOSTANZA
99C900B	- 236 x 37 mm
99C900	Cianuri
99C910	Formaldeide
99A360	Ipclorito di sodio
99C920	Latte di calce
99C930	Mandata salamoia
99C940	Ritorno di salamoia
99C950	Salamoia
99A351	Soda caustica

Etichette senza pittogrammi

CODICE	SOSTANZA (giallo ocra)
99000	Andata
99001	Ritorno
99002	Alimentazione
99003	Scarico

CODICE	SOSTANZA (marrone)
99100	Andata
99101	Ritorno
99102	Alimentazione
99103	Scarico

CODICE	SOSTANZA (viola)
99200	Andata
99201	Ritorno
99202	Alimentazione
99203	Scarico

CODICE	SOSTANZA (arancio)
99300	Andata
99301	Ritorno
99302	Alimentazione
99303	Scarico

CODICE	SOSTANZA (argento)
99400	Andata
99401	Ritorno
99402	Alimentazione
99403	Scarico

CODICE	SOSTANZA (azzurro)
99500	Andata
99501	Ritorno
99502	Alimentazione
99503	Scarico

CODICE	SOSTANZA (verde)
99600	Andata
99601	Ritorno
99602	Alimentazione
99603	Scarico

CODICE	SOSTANZA (rosso)
99700	Andata
99701	Ritorno
99702	Alimentazione
99703	Scarico

CODICE	SOSTANZA (nero)
99900	Andata
99901	Ritorno
99902	Alimentazione
99903	Scarico

TABELLA COLORAZIONE TUBAZIONI NORMATIVA UNI5634	
COLORE DI BASE*	SIGNIFICATO
	ACQUA
	VAPORE E ACQUA SURRISCALDATA
	OLI MINERALI, VEGETALI, ANIMALI, COMBUSTIBILI LIQUIDI
	GAS ALLO STATO GASSOSO O LIQUEFATTO (ESCLUSA L'ARIA)
	ACIDI
	ALCALI
	ARIA
	ALTRI FLUIDI
	ESTINZIONE INCENDI
	COMBURENTI

3809 - cartello colorazione tubazioni in alluminio, dimensioni mm 400 x 500, a norma UNI5634 € 43,80



CARTELLI DI INFORMAZIONE E VARI

LE PRIME DUE CIFRE DEL CODICE IDENTIFICANO IL FORMATO

CODICE	FORMATO	MATERIALE	PREZZO
26...	500 x 333 mm	Alluminio spessore 0,7 mm	€ 22,60
31...	300 x 200 mm	Alluminio spessore 0,5 mm	€ 9,70
31...S	300 x 200 mm	Pellicola autoadesiva	€ 6,00
48...	200 x 150 mm	Alluminio spessore 0,5 mm	€ 6,10
55...	200 x 100 mm	Alluminio spessore 0,5 mm	€ 5,70
55...S	200 x 100 mm	Pellicola autoadesiva	€ 5,10



ELEVATA RESISTENZA E DURATA. VEDI CARATTERISTICHE DEI MATERIALI A PAGINA 24.



2602

3174



2603



2604



2605



2606

3175



2607

3101

3101S

4825



2608

5507

5507S



2609

5508

5508S



2610



2611

3104



2612

3103



2613

3102



2624

3171



2625

3105

3105S

4825



2627

3180



2628

3109

3109S



2629

3197

3197S



2639



2640



2641



2658



2660



3110



3111



3112



3113



3114



3115



3116



3117

3117S



3118

3118S



3119

3119S



3120



3121

3121S



3124

3124S



3125



3126



3128



3129



3130



3131



3132



3133



3136



3138



3139

3139S



3140



3143

3143S



3144

3144S



3148

3148S



3149



3150

3150S



3151

3151S



3154



3155



3156



3160



3162



3163



3164



CARTELLI DI INFORMAZIONE E VARI

LE PRIME DUE CIFRE DEL CODICE IDENTIFICANO IL FORMATO

CODICE	FORMATO	MATERIALE	PREZZO
23..	350 x 125 mm	Alluminio spessore 0,5 mm	€ 8,80
26..	500 x 333 mm	Alluminio spessore 0,7 mm	€ 22,60
31..	300 x 200 mm	Alluminio spessore 0,5 mm	€ 9,70
31...5	300 x 200 mm	Pellicola autoadesiva	€ 6,00



ELEVATA RESISTENZA E DURATA. VEDI CARATTERISTICHE DEI MATERIALI A PAGINA 24.



3165

31655



3166



3168

31685



3172



3173



3176

31765



3177

31775



3178



3181



3183



3184



3186



3187



3188



3189



3192



3193

3193 5



3195



3198



3199



2642



2643



2649



3108

31085



3141

31415



3145



3161



3167



3169

31695



3170 3170S



3185 3185S



3194 26094



3196



3106



3107 3107S



3152 3152S



3157 3157S



3158 3158S



3179 3179S



3190 3190S



3191



2304



2305



2306



2316



2342

LE PRIME DUE CIFRE DEL CODICE IDENTIFICANO IL FORMATO

CODICE	FORMATO	MATERIALE	PREZZO
15...K	120 x 120 mm	Alluminio spessore 0,5 mm	€ 5,60
15...X	250 x 250 mm	Alluminio spessore 0,5 mm	€ 7,10
15...Y	400 x 400 mm	Alluminio spessore 0,7 mm	€ 24,60
15...Z	530 x 530 mm	Alluminio spessore 0,7 mm	€ 53,20
159...W	160 x 160 mm	Alluminio spessore 0,5 mm	€ 16,80
159...X	250 x 250 mm	Alluminio spessore 0,5 mm	€ 20,40
20...K	120 x 145 mm	Alluminio spessore 0,5 mm	€ 5,90
20...W	160 x 210 mm	Alluminio spessore 0,5 mm	€ 5,90
20...X	250 x 310 mm	Alluminio spessore 0,5 mm	€ 8,00
20...Y	400 x 500 mm	Alluminio spessore 0,7 mm	€ 32,00



15160 K X Y



15171 Z



15172 Z



15173 Z



15174 X Y Z



15175 X Y



15177 X Y



15113 K X Y



15901 W X



15902 W



20111 K X Y



20130 X



20167 X



20169 X



20144 X



20145 X



20146 W X Y



CARTELLI DI INFORMAZIONE E VARI

LE PRIME DUE CIFRE DEL CODICE IDENTIFICANO IL FORMATO

CODICE	FORMATO	MATERIALE	PREZZO
16...W	220 x 100 mm	Alluminio spessore 0,5 mm	€ 5,70
16...X	370 x 170 mm	Alluminio spessore 0,5 mm	€ 10,00
16...Y	580 x 260 mm	Alluminio spessore 0,7 mm	€ 35,20
48..	200 x 150 mm	Alluminio spessore 0,5 mm	€ 6,10
48..S	200 x 150 mm	Pellicola autoadesiva	€ 5,90

i I CARTELLI DELLA SERIE 48.. POSSONO ESSERE REALIZZATI CON SCRITTE DIVERSE. MAGGIORI INFORMAZIONI A PAGINA 20.



4801



4802



4803



4806



4809



4812



4813



4828



4829



4830



4831



4834



4835



4843



4844



4847



4848



4804



4808



4832



4833



4836



4837



4839



4840



4841



4842



4845



4846



4849



4850



4838



E4811



16104

X Y



16105

X



16107

W



ELEVATA RESISTENZA E DURATA. CARATTERISTICHE DEI MATERIALI A PAGINA 24.



LE PRIME DUE CIFRE DEL CODICE IDENTIFICANO IL FORMATO

CODICE	FORMATO	MATERIALE	PREZZO
21..	350 x 125 mm	Alluminio spessore 0,5 mm	€ 8,30
23..	350 x 125 mm	Alluminio spessore 0,5 mm	€ 8,80
23..S	350 x 125 mm	Pellicola autoadesiva	€ 4,90
55..	200 x 100 mm	Alluminio spessore 0,7 mm	€ 5,70
77..	150 x 150 mm	Magnetico spessore 0,75 mm	€ 9,50
78..	250 x 250 mm	Alluminio spessore 0,5 mm	€ 18,00
79..	160 x 160 mm	PVC rigido	€ 8,60

ELEVATA RESISTENZA E DURATA DEI MATERIALI (VEDI PAGINA 24).



2150



2307



2308



2309



2310



2311



2314



2320



2321



2323



2324



2326



2327



2328



2329



2340



2343



2345



2351



2352



2353



2355



5501



5502



5503



5510



5511

Segnaletica manutenzione macchinari

MONOFACCIALI (PITTOGRAMMA SU UN SOLO LATO)



77210
78210



77450
78450



E77460
E78460

BIFACCIALI (PITTOGRAMMA SU ENTRAMBI I LATI)



79210



79450



E79460

Segnaletica manutenzione macchinari con maniglia

Fornibili a richiesta con altri simboli e/o testi. Richiedi un preventivo.



80210



80450



E80460

Catene e anelli

Adatti per collocare cartelli serie 55.. 77.. 78.. e 79..

1 **CPK050** - confezione 25 pezzi da 50 cm di catenella mopen colore bianco tipo CP1011

2 **AGK102S** - confezione da 25 anelli a spirale per catenella CPK050



FORNIBILI A RICHIESTA CON ALTRE SCRITTE.





CARTELLI DI INFORMAZIONE E VARI

LE PRIME DUE CIFRE DEL CODICE IDENTIFICANO LA SERIE, LA PRIMA LETTERA IDENTIFICA IL FORMATO

CODICE	FORMATO	MATERIALE	PREZZO
E29./29.	333 x 500 mm	Alluminio spessore 0,7 mm	€ 23,60
E35../35..	200 x 300 mm	Alluminio spessore 0,5 mm	€ 10,00
35...S	200 x 300 mm	Pellicola autoadesiva	€ 8,00
E36...	333 x 470 mm	Alluminio spessore 0,7 mm	€ 27,60
37...	250 x 350 mm	Alluminio spessore 0,5 mm	€ 13,80
38...	400 x 500 mm	Alluminio spessore 0,7 mm	€ 43,80
43...	665 x 500 mm	Alluminio spessore 1 mm	€ 69,20
E45...	500 x 700 mm	Alluminio spessore 1 mm	€ 71,40
E48...	200 x 150 mm	Alluminio spessore 0,5 mm	€ 6,10
E48...S	200 x 150 mm	Pellicola autoadesiva	€ 5,90
56...J	600 x 400 mm	Alluminio spessore 0,7 mm	€ 50,60
280...	1000 x 1400 mm	Alluminio spessore 1 mm	€ 254,80
280...P	1000 x 1400 mm	PVC rigido spessore 1 mm	€ 163,60
281...	1500 x 1000 mm	Alluminio spessore 1 mm	€ 297,20
282...K	333 x 333 mm	Alluminio spessore 0,5 mm	€ 19,80
282...W	435 x 435 mm	Alluminio spessore 0,7 mm	€ 35,20
283...	652 x 833 mm	Alluminio spessore 1 mm	€ 123,20



2950

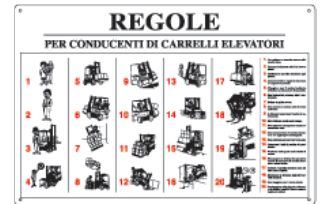

5670



3561



E3547



4322



E4810

E4810S



2953



E2960



E2964



E35230



E2968



E3523



3564



E3691



E3692



3768



E4553



E28002

E28002P



E28301



E28101



E28201

K W



E28202

K W

- RESPONSABILITÀ dell'ESERCIZIO e della MANUTENZIONE -
 DITTA **MARIO ROSSI** Concessionaria Milano
 Indirizzo: 20148 MILANO - Via MILANO, 10 Tel. (02) 46 80 84

ESEMPIO DI PERSONALIZZAZIONE (A RICHIESTA)





Cartelli di informazione e vari

LE PRIME DUE CIFRE DEL CODICE IDENTIFICANO IL FORMATO

CODICE	FORMATO	MATERIALE	PREZZO
33..	300 x 200 mm	Alluminio spessore 0,5 mm	€ 10,60
43..	500 x 665 mm	Alluminio spessore 1 mm	€ 69,20
47..	600 x 900 mm	Alluminio spessore 1 mm	€ 114,80
48..	200 x 150 mm	Alluminio spessore 0,5 mm	€ 6,10
5642 J	600 x 400 mm	Alluminio spessore 0,7 mm	€ 50,60
5688 Y	400 x 600 mm	Alluminio spessore 0,7 mm	€ 49,60
28502	270 x 650 mm	Alluminio spessore 0,7 mm	€ 58,60
28602	525 x 400 mm	Alluminio spessore 0,7 mm	€ 53,20



4316



4317

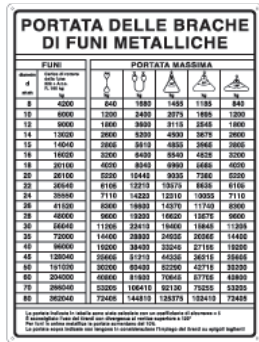

4318

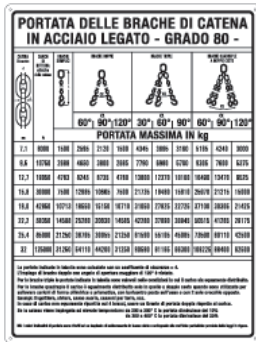

4319



4320



4700



3301



3302



3303



3304



3305

4805



3306



3315



3317



4807

! A CAUSA DELLE REVISIONI IN CORSO, I DATI PRESENTI SUI CARTELLI POTREBBERO VARIARE IN SEGUITO ALL'AGGIORNAMENTO DELLE NORMATIVE TECNICHE.

Cartelli "Obiettivo sicurezza"



5688

Y



5642

J



Cartelli per scale e tappeti mobili



28602



28502



CARTELLI DI NORME E ISTRUZIONI

LE PRIME DUE CIFRE DEL CODICE IDENTIFICANO IL FORMATO

CODICE	FORMATO	MATERIALE	COLORE	PREZZO
36..	333 x 470 mm	Alluminio spessore 0,7 mm		€ 27,60
37..	250 x 350 mm	Alluminio spessore 0,5 mm		€ 13,80
38..	400 x 500 mm	Alluminio spessore 0,7 mm	Fondo bianco Testo nero	€ 43,80
45..	500 x 700 mm	Alluminio spessore 1 mm	Bordino blu	€ 71,40
102..K	210 x 297 mm	Alluminio spessore 0,5 mm		€ 14,00
102..KS	210 x 297 mm	Pellicola autoadesiva		€ 8,00

PER RAGIONI DI IMPAGINAZIONE DEI TESTI E VISIBILITÀ, ALCUNI CARTELLI POTREBBERO ESSERE LEGGERMENTE DIVERSI DALLO STANDARD PRODOTTO.

RIMANE OBBLIGO DEL DATORE DI LAVORO VERIFICARE LA CONGRUITÀ DELLE INDICAZIONI CONTENUTE NELLE NORME ISTRUZIONI DEI SEGNALE A CATALOGO CON LE ATTREZZATURE O LE PROCEDURE E L'ORGANIZZAZIONE DEL LAVORO DELLA PROPRIA AZIENDA.



NORME GENERALI DI PREVENZIONE INFORTUNI

Reperto verniciatura

È NIENTO

- Prima di usare l'attrezzo leggere attentamente le istruzioni e i simboli di avvertimento.
- Non usare l'attrezzo se non è stato specificato che è adatto per il tipo di lavoro.
- Non usare l'attrezzo se non è stato specificato che è adatto per il tipo di lavoro.
- Non usare l'attrezzo se non è stato specificato che è adatto per il tipo di lavoro.

È OBBLIGO

- Prima di usare l'attrezzo leggere attentamente le istruzioni e i simboli di avvertimento.
- Non usare l'attrezzo se non è stato specificato che è adatto per il tipo di lavoro.
- Non usare l'attrezzo se non è stato specificato che è adatto per il tipo di lavoro.
- Non usare l'attrezzo se non è stato specificato che è adatto per il tipo di lavoro.

È OBBLIGO

- Prima di usare l'attrezzo leggere attentamente le istruzioni e i simboli di avvertimento.
- Non usare l'attrezzo se non è stato specificato che è adatto per il tipo di lavoro.
- Non usare l'attrezzo se non è stato specificato che è adatto per il tipo di lavoro.
- Non usare l'attrezzo se non è stato specificato che è adatto per il tipo di lavoro.

3633

NORME DI SICUREZZA PER LAVORI DI FALEGNAMERIA

- PRIMA DI INIZIARE IL LAVORO assicurarsi che la macchina sia in ordine e che i ripari di cui è provvista siano al loro posto ed in buono stato.
- Verificare sempre che gli attrezzi applicati alla macchina siano bene AFFILATI e FISSATI con la massima sicurezza.
- Ad ogni operazione di lavoro o in caso di imprevista mancanza di energia, mettere la macchina in POSIZIONE DI ARRESTO.
- Durante il lavoro alle macchine USARE OCCHIALI DI PROTEZIONE.
- Assocare con ogni precauzione il pezzo da lavorare PRESIENDOLO GRADUALMENTE contro la macchina. Evitare di tenere il pezzo in contropressione della parte lavorata dell'attrezzo.
- Disporre il materiale con ordine, non ingombrare i passaggi, SPECIALMENTE IN PROSSIMITÀ DELLE MACCHINE; ed evitavano urti e cadute a chi lavora.

3634

ISTRUZIONI PER L'USO DEI MATERIALI CONTENUTI NELLA CASSETTA PRONTO SOCCORSO

1. Leggere attentamente le istruzioni per l'uso di ogni materiale contenuto nella cassetta pronto soccorso.

2. Assicurarsi che il materiale sia in buone condizioni di conservazione e che non sia scaduto.

3. Assicurarsi che il materiale sia in buone condizioni di conservazione e che non sia scaduto.

4. Assicurarsi che il materiale sia in buone condizioni di conservazione e che non sia scaduto.

5. Assicurarsi che il materiale sia in buone condizioni di conservazione e che non sia scaduto.

3635

IMPIANTI E APPARECCHIATURE ELETTRICHE

ISTRUZIONI E AVVERTENZE

- Il presente manuale è destinato a essere letto e compreso da tutti i lavoratori che lavorano in presenza di impianti e apparecchiature elettriche.
- Il presente manuale è destinato a essere letto e compreso da tutti i lavoratori che lavorano in presenza di impianti e apparecchiature elettriche.
- Il presente manuale è destinato a essere letto e compreso da tutti i lavoratori che lavorano in presenza di impianti e apparecchiature elettriche.
- Il presente manuale è destinato a essere letto e compreso da tutti i lavoratori che lavorano in presenza di impianti e apparecchiature elettriche.

3636

ASCENSORI PER TRASPORTO DI COSE ACCOMPAGNATE DA PERSONE

NORME DI SICUREZZA

1. L'operatore deve essere adeguatamente formato e autorizzato per l'uso e per la manutenzione di questo apparecchio.
2. La marcia e l'uso dell'ascensore sono riservati al personale addetto.
3. È vietato trasportare un carico superiore a quello stabilito e indicato nella apposita targhetta.
4. La corsa di marcia deve essere controllata con cura e stabilita in modo da non superare i limiti consentiti.
5. Non caricare l'ascensore se la porta non è chiusa, e prima che la porta sia chiusa e il sistema di sicurezza sia in funzione.
6. Non caricare l'ascensore se la porta non è chiusa, e prima che la porta sia chiusa e il sistema di sicurezza sia in funzione.
7. Non caricare l'ascensore se la porta non è chiusa, e prima che la porta sia chiusa e il sistema di sicurezza sia in funzione.
8. Non caricare l'ascensore se la porta non è chiusa, e prima che la porta sia chiusa e il sistema di sicurezza sia in funzione.
9. Non caricare l'ascensore se la porta non è chiusa, e prima che la porta sia chiusa e il sistema di sicurezza sia in funzione.
10. Non caricare l'ascensore se la porta non è chiusa, e prima che la porta sia chiusa e il sistema di sicurezza sia in funzione.
11. Non caricare l'ascensore se la porta non è chiusa, e prima che la porta sia chiusa e il sistema di sicurezza sia in funzione.
12. Non caricare l'ascensore se la porta non è chiusa, e prima che la porta sia chiusa e il sistema di sicurezza sia in funzione.
13. Non caricare l'ascensore se la porta non è chiusa, e prima che la porta sia chiusa e il sistema di sicurezza sia in funzione.
14. Non caricare l'ascensore se la porta non è chiusa, e prima che la porta sia chiusa e il sistema di sicurezza sia in funzione.
15. Non caricare l'ascensore se la porta non è chiusa, e prima che la porta sia chiusa e il sistema di sicurezza sia in funzione.
16. Non caricare l'ascensore se la porta non è chiusa, e prima che la porta sia chiusa e il sistema di sicurezza sia in funzione.
17. Non caricare l'ascensore se la porta non è chiusa, e prima che la porta sia chiusa e il sistema di sicurezza sia in funzione.
18. Non caricare l'ascensore se la porta non è chiusa, e prima che la porta sia chiusa e il sistema di sicurezza sia in funzione.
19. Non caricare l'ascensore se la porta non è chiusa, e prima che la porta sia chiusa e il sistema di sicurezza sia in funzione.
20. Non caricare l'ascensore se la porta non è chiusa, e prima che la porta sia chiusa e il sistema di sicurezza sia in funzione.

3637

NORME PER LA SALDATURA OSSIAETILENICA

1. Prima di iniziare il lavoro leggere attentamente le istruzioni e i simboli di avvertimento.
2. Assicurarsi che il materiale sia in buone condizioni di conservazione e che non sia scaduto.
3. Assicurarsi che il materiale sia in buone condizioni di conservazione e che non sia scaduto.
4. Assicurarsi che il materiale sia in buone condizioni di conservazione e che non sia scaduto.
5. Assicurarsi che il materiale sia in buone condizioni di conservazione e che non sia scaduto.
6. Assicurarsi che il materiale sia in buone condizioni di conservazione e che non sia scaduto.
7. Assicurarsi che il materiale sia in buone condizioni di conservazione e che non sia scaduto.
8. Assicurarsi che il materiale sia in buone condizioni di conservazione e che non sia scaduto.
9. Assicurarsi che il materiale sia in buone condizioni di conservazione e che non sia scaduto.
10. Assicurarsi che il materiale sia in buone condizioni di conservazione e che non sia scaduto.
11. Assicurarsi che il materiale sia in buone condizioni di conservazione e che non sia scaduto.
12. Assicurarsi che il materiale sia in buone condizioni di conservazione e che non sia scaduto.
13. Assicurarsi che il materiale sia in buone condizioni di conservazione e che non sia scaduto.
14. Assicurarsi che il materiale sia in buone condizioni di conservazione e che non sia scaduto.
15. Assicurarsi che il materiale sia in buone condizioni di conservazione e che non sia scaduto.
16. Assicurarsi che il materiale sia in buone condizioni di conservazione e che non sia scaduto.
17. Assicurarsi che il materiale sia in buone condizioni di conservazione e che non sia scaduto.
18. Assicurarsi che il materiale sia in buone condizioni di conservazione e che non sia scaduto.
19. Assicurarsi che il materiale sia in buone condizioni di conservazione e che non sia scaduto.
20. Assicurarsi che il materiale sia in buone condizioni di conservazione e che non sia scaduto.

CONTROLLI DA EFFETTUARE PERIODICAMENTE

1. Verificare lo stato di conservazione e l'efficienza delle apparecchiature.
2. Verificare lo stato di conservazione e l'efficienza delle apparecchiature.
3. Verificare lo stato di conservazione e l'efficienza delle apparecchiature.
4. Verificare lo stato di conservazione e l'efficienza delle apparecchiature.
5. Verificare lo stato di conservazione e l'efficienza delle apparecchiature.
6. Verificare lo stato di conservazione e l'efficienza delle apparecchiature.
7. Verificare lo stato di conservazione e l'efficienza delle apparecchiature.
8. Verificare lo stato di conservazione e l'efficienza delle apparecchiature.
9. Verificare lo stato di conservazione e l'efficienza delle apparecchiature.
10. Verificare lo stato di conservazione e l'efficienza delle apparecchiature.
11. Verificare lo stato di conservazione e l'efficienza delle apparecchiature.
12. Verificare lo stato di conservazione e l'efficienza delle apparecchiature.
13. Verificare lo stato di conservazione e l'efficienza delle apparecchiature.
14. Verificare lo stato di conservazione e l'efficienza delle apparecchiature.
15. Verificare lo stato di conservazione e l'efficienza delle apparecchiature.
16. Verificare lo stato di conservazione e l'efficienza delle apparecchiature.
17. Verificare lo stato di conservazione e l'efficienza delle apparecchiature.
18. Verificare lo stato di conservazione e l'efficienza delle apparecchiature.
19. Verificare lo stato di conservazione e l'efficienza delle apparecchiature.
20. Verificare lo stato di conservazione e l'efficienza delle apparecchiature.

3638

NORME DI SICUREZZA PER L'USO DEI CARRELLI ELEVATORI

1. Non operare il carrello fuori della zona di lavoro, e non mettere mai il piede sulla guida del dispositivo di avviamento del carrello.
2. Assicurarsi che il carrello sia in buone condizioni di conservazione e che non sia scaduto.
3. Assicurarsi che il carrello sia in buone condizioni di conservazione e che non sia scaduto.
4. Assicurarsi che il carrello sia in buone condizioni di conservazione e che non sia scaduto.
5. Assicurarsi che il carrello sia in buone condizioni di conservazione e che non sia scaduto.
6. Assicurarsi che il carrello sia in buone condizioni di conservazione e che non sia scaduto.
7. Assicurarsi che il carrello sia in buone condizioni di conservazione e che non sia scaduto.
8. Assicurarsi che il carrello sia in buone condizioni di conservazione e che non sia scaduto.
9. Assicurarsi che il carrello sia in buone condizioni di conservazione e che non sia scaduto.
10. Assicurarsi che il carrello sia in buone condizioni di conservazione e che non sia scaduto.
11. Assicurarsi che il carrello sia in buone condizioni di conservazione e che non sia scaduto.
12. Assicurarsi che il carrello sia in buone condizioni di conservazione e che non sia scaduto.
13. Assicurarsi che il carrello sia in buone condizioni di conservazione e che non sia scaduto.
14. Assicurarsi che il carrello sia in buone condizioni di conservazione e che non sia scaduto.
15. Assicurarsi che il carrello sia in buone condizioni di conservazione e che non sia scaduto.
16. Assicurarsi che il carrello sia in buone condizioni di conservazione e che non sia scaduto.
17. Assicurarsi che il carrello sia in buone condizioni di conservazione e che non sia scaduto.
18. Assicurarsi che il carrello sia in buone condizioni di conservazione e che non sia scaduto.
19. Assicurarsi che il carrello sia in buone condizioni di conservazione e che non sia scaduto.
20. Assicurarsi che il carrello sia in buone condizioni di conservazione e che non sia scaduto.

3639

COSA FARE IN CASO DI CONTATTO CON L'ACIDO CLORIDRICO

1. Allontanarsi immediatamente dalla zona contaminata.

2. Rimuovere i vestiti contaminati.

3. Lavare le parti colpite con abbondante acqua.

4. Cercare assistenza medica.

5. Cercare assistenza medica.

6. Cercare assistenza medica.

7. Cercare assistenza medica.

8. Cercare assistenza medica.

9. Cercare assistenza medica.

10. Cercare assistenza medica.

11. Cercare assistenza medica.

12. Cercare assistenza medica.

13. Cercare assistenza medica.

14. Cercare assistenza medica.

15. Cercare assistenza medica.

16. Cercare assistenza medica.

17. Cercare assistenza medica.

18. Cercare assistenza medica.

19. Cercare assistenza medica.

20. Cercare assistenza medica.

3640

NORME DI SICUREZZA PER L'USO DELLA MOLA

1. Prima di usare la mola leggere attentamente le istruzioni e i simboli di avvertimento.
2. Assicurarsi che la mola sia in buone condizioni di conservazione e che non sia scaduta.
3. Assicurarsi che la mola sia in buone condizioni di conservazione e che non sia scaduta.
4. Assicurarsi che la mola sia in buone condizioni di conservazione e che non sia scaduta.
5. Assicurarsi che la mola sia in buone condizioni di conservazione e che non sia scaduta.
6. Assicurarsi che la mola sia in buone condizioni di conservazione e che non sia scaduta.
7. Assicurarsi che la mola sia in buone condizioni di conservazione e che non sia scaduta.
8. Assicurarsi che la mola sia in buone condizioni di conservazione e che non sia scaduta.
9. Assicurarsi che la mola sia in buone condizioni di conservazione e che non sia scaduta.
10. Assicurarsi che la mola sia in buone condizioni di conservazione e che non sia scaduta.
11. Assicurarsi che la mola sia in buone condizioni di conservazione e che non sia scaduta.
12. Assicurarsi che la mola sia in buone condizioni di conservazione e che non sia scaduta.
13. Assicurarsi che la mola sia in buone condizioni di conservazione e che non sia scaduta.
14. Assicurarsi che la mola sia in buone condizioni di conservazione e che non sia scaduta.
15. Assicurarsi che la mola sia in buone condizioni di conservazione e che non sia scaduta.
16. Assicurarsi che la mola sia in buone condizioni di conservazione e che non sia scaduta.
17. Assicurarsi che la mola sia in buone condizioni di conservazione e che non sia scaduta.
18. Assicurarsi che la mola sia in buone condizioni di conservazione e che non sia scaduta.
19. Assicurarsi che la mola sia in buone condizioni di conservazione e che non sia scaduta.
20. Assicurarsi che la mola sia in buone condizioni di conservazione e che non sia scaduta.

3641

NORME DI SICUREZZA PER L'USO DI RECIPIENTI CONTENENTI GAS COMPRESI

1. Leggere attentamente le istruzioni e i simboli di avvertimento.
2. Assicurarsi che il recipiente sia in buone condizioni di conservazione e che non sia scaduto.
3. Assicurarsi che il recipiente sia in buone condizioni di conservazione e che non sia scaduto.
4. Assicurarsi che il recipiente sia in buone condizioni di conservazione e che non sia scaduto.
5. Assicurarsi che il recipiente sia in buone condizioni di conservazione e che non sia scaduto.
6. Assicurarsi che il recipiente sia in buone condizioni di conservazione e che non sia scaduto.
7. Assicurarsi che il recipiente sia in buone condizioni di conservazione e che non sia scaduto.
8. Assicurarsi che il recipiente sia in buone condizioni di conservazione e che non sia scaduto.
9. Assicurarsi che il recipiente sia in buone condizioni di conservazione e che non sia scaduto.
10. Assicurarsi che il recipiente sia in buone condizioni di conservazione e che non sia scaduto.
11. Assicurarsi che il recipiente sia in buone condizioni di conservazione e che non sia scaduto.
12. Assicurarsi che il recipiente sia in buone condizioni di conservazione e che non sia scaduto.
13. Assicurarsi che il recipiente sia in buone condizioni di conservazione e che non sia scaduto.
14. Assicurarsi che il recipiente sia in buone condizioni di conservazione e che non sia scaduto.
15. Assicurarsi che il recipiente sia in buone condizioni di conservazione e che non sia scaduto.
16. Assicurarsi che il recipiente sia in buone condizioni di conservazione e che non sia scaduto.
17. Assicurarsi che il recipiente sia in buone condizioni di conservazione e che non sia scaduto.
18. Assicurarsi che il recipiente sia in buone condizioni di conservazione e che non sia scaduto.
19. Assicurarsi che il recipiente sia in buone condizioni di conservazione e che non sia scaduto.
20. Assicurarsi che il recipiente sia in buone condizioni di conservazione e che non sia scaduto.

3642

AVVISO

I pavimenti ed i passaggi non devono essere ingombrati da materiale che ostacoli la normale circolazione.

Tale prescrizione è da osservarsi in ottemperanza al disposto dell'Allegato IV del D.Lgs. 81/2008 relativo alle norme sulla sicurezza sul lavoro.

Quando per evidenti ragioni tecniche non si possono completamente eliminare dalle zone di transito ostacoli fissi o mobili che costituiscono un pericolo per i lavoratori o i veicoli che tali zone devono percorrere, gli ostacoli devono essere adeguatamente segnalati.

La Direzione

3647

NORME SPECIFICHE DI SICUREZZA PER MANOVRA TORI DI SCAFFALATORI

1. prima di mettere in moto lo scaffalatore assicurarsi che i comandi siano liberi da persone e da ingombri.
2. per la messa in marcia inserire l'apposita chiave nel quadro di comando.
3. in caso di emergenza premere il pulsante rosso (emergenza).
4. al termine del lavoro e nel caso di abbandono dello scaffalatore togliere la chiave dal quadro e premere il pulsante rosso (emergenza).
5. all'inizio di ogni turno di lavoro controllare l'efficienza dei freni e del fine corsa elettrici -avvisare in caso di inefficienza il capo reparto.
6. evitare che durante la discesa il telaio si appoggi sopra eventuali ingombri - (le funi devono essere sempre tese).
7. non trasportare carichi che sporgano dalla estremità del telaio.
8. in caso di avaria forzata il recupero dell'operatore deve essere predisposto dal basso con mazzoli idonei. Solo attraverso questi mazzoli il manovratore potrà scendere a terra.

3648

3748



IN CASO DI INCENDIO

SEGUIRE, CON LA SUCCESSIONE PIÙ IDONEA, LE SEGUENTI NORME DI MASSIMA:

- 1. NON IMPROVVISAMENTE CALLARE ED ALLONTANARE OGNI TALI PERSONE PRESENTI IN LOCALE PULCRIZIONE.
- 2. METTERE FUORI INFERNO E SOTTOCANTIERE E LE APPARECCHIA TURE INSTALLATE NELLA ZONA PERICOLOSA DALL'INCENDIO E NELLE SUE MANSIONI PULCRIZIONE.
- 3. TENERE GLI OGGETTI IMPEDIRE VENTILAZIONE E DI DONDA SOSTEGNO AFFRONTAMENTO INCENDIO.
- 4. ACCORDARE GLI EVENTUALI DISPOSITIVI ANTINCENDIO E I CONTRO SOLEI IN TERMINI DELLA VERBALE AL CORPO PULCRIZIONE (LAVORI, LAVORI, LAVORI).
- 5. ALLERTARE E SPERANZE I NEGOZIANTO MOLI (SOMMO, LAVORI, LAVORI).
- 6. CERCARE DI QUANTO POSSIBILE I NEGOZIANTI PULCRIZIONE E INFERNO E IMPEDIRE CHE POSSONO VOLO PULCRIZIONE DAL FUOCO.
- 7. NON SEGUIRE IN CASO DI INCENDIO INVALI, INTERVENTO OGGI INVALI, LAVORI, LAVORI.
- 8. NO MOVIMENTO, CONTROLLI ANTINCENDIO CHE NON SOSTEGNO PULCRIZIONE OGGI INVALI NON SOSTEGNO PULCRIZIONE OGGI INVALI SIA PULCRIZIONE LA CUFFIA DELLA PULCRIZIONE SIA PULCRIZIONE DELLA PULCRIZIONE.
- 9. LA PULCRIZIONE DEL NEGOZIANTE NON VERBALE ATTIVA SOTTO PULCRIZIONE VOLE PULCRIZIONE, PULCRIZIONE, CUFFIA DELLA PULCRIZIONE.

VIGILI DEL FUOCO - TEL. N. 115

3649 3749

CODICE DEI SEGNALI GESTUALI E VERBALI

3650

SCALE PORTATILI A PIOLI E GRADINI

NORME DI SICUREZZA

1. Scegliere sempre scale tali da sporgere o sovrastare oltre il livello di lavoro e avere una data di scadenza garantita con una etichetta.
2. Prima dell'uso accertare che le scale siano in buono stato di manutenzione e conformate alle norme.
3. Controllare che i dispositivi antiscivolo siano in grado di funzionare e che le scale siano pulite e asciutte.
4. Particolare attenzione deve essere data al fatto che le scale siano sempre usate con l'angolo della parte superiore e inferiore dei gradini, e non qualsiasi disposizione, anche se, o risarcimento ad altre soluzioni di questo tipo che non siano autorizzate.
5. Verificare che le scale appoggiate su un supporto stabile, naturale, di dimensioni adeguate e fissate, in modo da garantire la posizione orizzontale dei pioli e gradini.
6. Dare alla scala una inclinazione corretta. Di solito la distanza tra i gradini deve essere di 20-25 cm e il gradino deve essere di 10-12 cm di altezza.
7. Accertarsi dell'assenza di ostacoli e di altri elementi che possano interferire con l'uso delle scale.
8. Quando si usano le scale, tenere gli attenti nella posizione corretta e non scendere o salire con le mani.
9. Evitare di usare le scale con carichi di peso o di dimensioni superiori a quelle consentite e non di peso o di dimensioni superiori a quelle consentite.
10. Evitare di usare le scale in modo non autorizzato.

IN GENERALE

1. Quando si usano le scale, tenere gli attenti nella posizione corretta e non scendere o salire con le mani.
2. Evitare di usare le scale con carichi di peso o di dimensioni superiori a quelle consentite e non di peso o di dimensioni superiori a quelle consentite.
3. Evitare di usare le scale in modo non autorizzato.

SCALARE DOPPIE

1. Accertarsi dell'assenza di ostacoli e di altri elementi che possano interferire con l'uso delle scale.
2. Quando si usano le scale, tenere gli attenti nella posizione corretta e non scendere o salire con le mani.
3. Evitare di usare le scale con carichi di peso o di dimensioni superiori a quelle consentite e non di peso o di dimensioni superiori a quelle consentite.

IN GENERALE

1. Quando si usano le scale, tenere gli attenti nella posizione corretta e non scendere o salire con le mani.
2. Evitare di usare le scale con carichi di peso o di dimensioni superiori a quelle consentite e non di peso o di dimensioni superiori a quelle consentite.
3. Evitare di usare le scale in modo non autorizzato.

SCALARE DOPPIE

1. Accertarsi dell'assenza di ostacoli e di altri elementi che possano interferire con l'uso delle scale.
2. Quando si usano le scale, tenere gli attenti nella posizione corretta e non scendere o salire con le mani.
3. Evitare di usare le scale con carichi di peso o di dimensioni superiori a quelle consentite e non di peso o di dimensioni superiori a quelle consentite.

3653 3753

NORME GENERALI PREVENZIONE INFORTUNI

OBBLIGHI DEI LAVORATORI

1. Osservare le norme di sicurezza e le istruzioni di lavoro.
2. Segnalare immediatamente al datore di lavoro o al responsabile della sicurezza ogni situazione di pericolo.
3. Partecipare attivamente alle attività di formazione e di informazione.
4. Utilizzare correttamente i dispositivi di protezione individuale (DPI) forniti.
5. Mantenere pulite e in buone condizioni le attrezzature e i luoghi di lavoro.
6. Evitare di usare attrezzature o macchine non autorizzate.
7. Evitare di usare attrezzature o macchine non autorizzate.
8. Evitare di usare attrezzature o macchine non autorizzate.
9. Evitare di usare attrezzature o macchine non autorizzate.
10. Evitare di usare attrezzature o macchine non autorizzate.

NORME DI COMPORTAMENTO

1. Evitare di usare attrezzature o macchine non autorizzate.
2. Evitare di usare attrezzature o macchine non autorizzate.
3. Evitare di usare attrezzature o macchine non autorizzate.
4. Evitare di usare attrezzature o macchine non autorizzate.
5. Evitare di usare attrezzature o macchine non autorizzate.
6. Evitare di usare attrezzature o macchine non autorizzate.
7. Evitare di usare attrezzature o macchine non autorizzate.
8. Evitare di usare attrezzature o macchine non autorizzate.
9. Evitare di usare attrezzature o macchine non autorizzate.
10. Evitare di usare attrezzature o macchine non autorizzate.

3655 4525 10205 K KS

OBBLIGHI DEI LAVORATORI

SE SI DEVE REALIZZARE UN CARICO DA TERRA

SE SI DEVO SPORARE DEI CARICHI

SE SI DEVE PORRE IN ALTO UN CARICO

QUANDO SI TRASPORTANO DEI CARICHI

3659 3759

COME MOVIMENTARE MANUALMENTE UN CARICO

SE SI DEVE REALIZZARE UN CARICO DA TERRA

SE SI DEVO SPORARE DEI CARICHI

SE SI DEVE PORRE IN ALTO UN CARICO

QUANDO SI TRASPORTANO DEI CARICHI

3663

SCALARE DOPPIE 1. Accertarsi dell'assenza di ostacoli e di altri elementi che possano interferire con l'uso delle scale. 2. Quando si usano le scale, tenere gli attenti nella posizione corretta e non scendere o salire con le mani. 3. Evitare di usare le scale con carichi di peso o di dimensioni superiori a quelle consentite e non di peso o di dimensioni superiori a quelle consentite.

3673

SCALARE DOPPIE 1. Accertarsi dell'assenza di ostacoli e di altri elementi che possano interferire con l'uso delle scale. 2. Quando si usano le scale, tenere gli attenti nella posizione corretta e non scendere o salire con le mani. 3. Evitare di usare le scale con carichi di peso o di dimensioni superiori a quelle consentite e non di peso o di dimensioni superiori a quelle consentite.

3674

NORME DI SICUREZZA PER L'USO DELLE PIALLETRICI

PRELAVORI

1. Regolare l'apertura del piano di lavoro in modo da evitare il più possibile la sua rotazione durante l'uso.
2. Non rendere inattivo o non bloccato il copritraccia.
3. La parte di lama inattiva deve essere sempre coperta dal copritraccia, regolare il riparo stesso di volta in volta, secondo la larghezza del tagliare da lavorare.
4. Per la lavorazione di piccoli pezzi usare gli speciali apertori.

PRIMA DI SPORARE

1. Provvedere l'abbigliamento di essere con il corpo e il braccio alla macchina e non dietro di essa.
2. La pelle e le spesse sono provviste talvolta di una serie di linguette o pendolini occlusivi che trattengono i pezzi rifiniti.
3. In assenza di tale dispositivo non si devono introdurre trascinando nella macchina pezzi che abbiano spessore diverso, anche di poco, per evitare il rifilare.
4. Lavorando due pezzi alla volta, distaccarli alla fine dell'operazione.

3751

BETONIERE

NORME DI SICUREZZA

1. Tenere applicati i ripari al motore, alle cinghie e pulegge, agli ingranaggi.
2. Tenere coperti e protetti il cavo elettrico, i suoi attacchi e l'interruttore. Non toccarli stando nel bagnato o con le mani bagnate. Tenere in buono stato il collegamento di terra e il dispositivo che ne fa le veci.
3. Tenere in buono stato la lama e il freno della betoniera per il corretto funzionamento subito dopo il carico. Tenere applicati i ripari al filo delle guide, dentate e impedire il transito o la scorta sotto la betoniera, o la caduta entro la fossa.
4. Tenersi lontani dalle parti rotanti. Non introdurre oggetti o parti del corpo. Non indossare indumenti con parti sciolte o avvolgenti, scarpe e cinture.
5. Tenersi abitualmente sotto la betoniera durante o perpendicolare delle cadute di materiali dai vicini piani o apparecchi di sollevamento.
6. Negli spostamenti, ricordare di legare la betoniera al cavo elettrico, staccando dalla presa o, almeno, aprendo l'interruttore al suo fianco.

3752

NORME DI SICUREZZA PER L'USO DELLE FRESATRICI AD ASSE VERTICALE (couplets)

1. Nei lavori non guidati, avvicinare la loro quanto più possibile le parti mobili della guida: se la lunga non è fessata il dispositivo premere il pezzo superiore di parti elastici in legno.
2. Rimuovere accuratamente e saldamente i cellulari durante il lavoro in modo che non possano sfuggire durante il lavoro.
3. Scegliere, montare e regolare accuratamente il riparo adatto al genere di lavoro da eseguire, affinché le mani non possano mai venire a contatto con le lame o fra esse.
4. Fermare la macchina se diventa allontanarsi anche per breve tempo.
5. Nella guida, avvicinare la loro quanto più possibile le parti mobili della guida: se la lunga non è fessata il dispositivo premere il pezzo superiore di parti elastici in legno.
6. Rimuovere accuratamente e saldamente i cellulari durante il lavoro in modo che non possano sfuggire durante il lavoro.
7. Scegliere, montare e regolare accuratamente il riparo adatto al genere di lavoro da eseguire, affinché le mani non possano mai venire a contatto con le lame o fra esse.
8. Fermare la macchina se diventa allontanarsi anche per breve tempo.
9. Nella guida, avvicinare la loro quanto più possibile le parti mobili della guida: se la lunga non è fessata il dispositivo premere il pezzo superiore di parti elastici in legno.
10. Rimuovere accuratamente e saldamente i cellulari durante il lavoro in modo che non possano sfuggire durante il lavoro.

3754

NORME DI SICUREZZA PER L'USO DEL TRAPANO

1. FISSARE ACCURATAMENTE il pezzo da lavorare sul piano di lavoro e fissare il pezzo da trapanare sulla parte rotante.
2. Per i piccoli pezzi USARE LE APPOSITE MASCHERINE, PIAZZE E MOVIMENTI che, oltre ad evitare la pericolosa vibrazione della mano alla parte rotante, assicurano una più precisa lavorazione.
3. DURANTE IL LAVORO USARE OCCASIONALMENTE DI PROTEZIONE.
4. INDOSSARE INDUMENTI ADEGUATI senza parti sciolte (ad esempio: cravatte, cravatte, ecc.) che possono essere trascinati dalla parte rotante.
5. FERMARE SEMPRE il trapano per le operazioni di lubrificazione, pulizia e riparazione.
6. Usare ogni attenzione per evitare l'autoavvicinamento e lo sfuggire dal campo d'azione del trapano.

3758

ISTRUZIONI PER INDOSSARE CORRETTAMENTE LE CUFFIE PROTETTIVE

1. Infilare la cuffia e premere la parte superiore della cuffia contro il cranio.
2. Tenere la cuffia premuta contro il cranio e premere la parte superiore della cuffia contro il cranio.
3. Infilare la cuffia e premere la parte superiore della cuffia contro il cranio.
4. Tenere la cuffia premuta contro il cranio e premere la parte superiore della cuffia contro il cranio.

3761

ISTRUZIONI PER IL CORRETTO INSERIMENTO DEI FILTRI AURICOLARI

1. Inserire il filtro nel condotto uditivo e premere la parte superiore del filtro contro il cranio.
2. Inserire il filtro nel condotto uditivo e premere la parte superiore del filtro contro il cranio.
3. Inserire il filtro nel condotto uditivo e premere la parte superiore del filtro contro il cranio.
4. Inserire il filtro nel condotto uditivo e premere la parte superiore del filtro contro il cranio.

3762

Norme di comportamento in caso di EMERGENZA

SE SI DEVE REALIZZARE UN CARICO DA TERRA

SE SI DEVO SPORARE DEI CARICHI

SE SI DEVE PORRE IN ALTO UN CARICO

QUANDO SI TRASPORTANO DEI CARICHI

E3782 E3807

NORME DI COMPORTAMENTO IN CASO DI EMERGENZA

EMERGENZA

1. SEGUIRE LE ISTRUZIONI DEL RESPONSABILE DELLA SICUREZZA E DEL RESPONSABILE DELLA SICUREZZA.
2. SEGUIRE LE ISTRUZIONI DEL RESPONSABILE DELLA SICUREZZA E DEL RESPONSABILE DELLA SICUREZZA.
3. SEGUIRE LE ISTRUZIONI DEL RESPONSABILE DELLA SICUREZZA E DEL RESPONSABILE DELLA SICUREZZA.
4. SEGUIRE LE ISTRUZIONI DEL RESPONSABILE DELLA SICUREZZA E DEL RESPONSABILE DELLA SICUREZZA.
5. SEGUIRE LE ISTRUZIONI DEL RESPONSABILE DELLA SICUREZZA E DEL RESPONSABILE DELLA SICUREZZA.
6. SEGUIRE LE ISTRUZIONI DEL RESPONSABILE DELLA SICUREZZA E DEL RESPONSABILE DELLA SICUREZZA.
7. SEGUIRE LE ISTRUZIONI DEL RESPONSABILE DELLA SICUREZZA E DEL RESPONSABILE DELLA SICUREZZA.
8. SEGUIRE LE ISTRUZIONI DEL RESPONSABILE DELLA SICUREZZA E DEL RESPONSABILE DELLA SICUREZZA.
9. SEGUIRE LE ISTRUZIONI DEL RESPONSABILE DELLA SICUREZZA E DEL RESPONSABILE DELLA SICUREZZA.
10. SEGUIRE LE ISTRUZIONI DEL RESPONSABILE DELLA SICUREZZA E DEL RESPONSABILE DELLA SICUREZZA.

E3784 E3804



CARTELLI DI NORME E ISTRUZIONI

LE PRIME DUE CIFRE DEL CODICE IDENTIFICANO LA SERIE, LA PRIMA LETTERA IDENTIFICA IL FORMATO

CODICE	FORMATO	MATERIALE	PREZZO
26..	500 x 333 mm	Alluminio spessore 0,7 mm	€ 22,60
33..	300 x 200 mm	Alluminio spessore 0,5 mm	€ 10,60
36..	470 x 333 mm	Alluminio spessore 0,7 mm	€ 27,60
37..	250 x 350 mm	Alluminio spessore 0,5 mm	€ 13,80
38..	400 x 500 mm	Alluminio spessore 0,7 mm	€ 43,80
43..	665 x 500 mm	Alluminio spessore 1 mm	€ 69,20
45..	500 x 700 mm	Alluminio spessore 1 mm	€ 71,40
102..K	210 x 297 mm	Alluminio spessore 0,5 mm	€ 14,00
102..KS	210 x 297 mm	Pellicola autoadesiva	€ 8,00
102..W	297 x 420 mm	Alluminio spessore 0,7 mm	€ 25,60
102..WS	297 x 420 mm	Pellicola autoadesiva	€ 11,40



3651 *



3764 *

* Le indicazioni riportate nei cartelli 3651 e 3652 "Indicazioni di base per la rianimazione..." sono estratte da fonti autorevoli internazionali del settore del primo intervento e della rianimazione; verificare che le istruzioni riportate nei segnali corrispondono con quelle specifiche dei DAE installati nell'ambiente di lavoro.



3801



3802

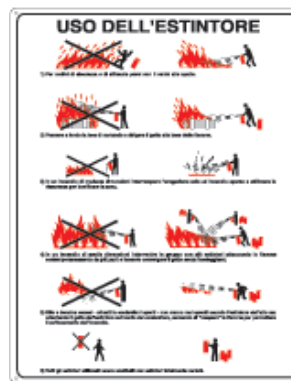

3808



4555



4538

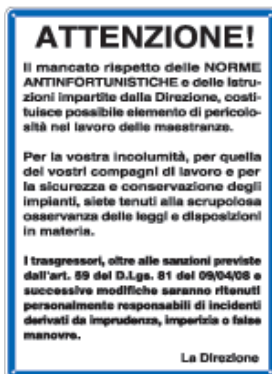

4542



10207

W WS



E10210

K KS



10201

K KS W WS

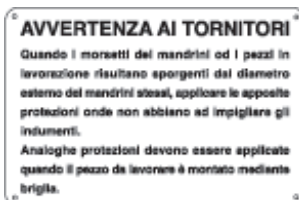

2614



2616



3359

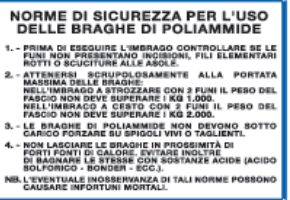

3644

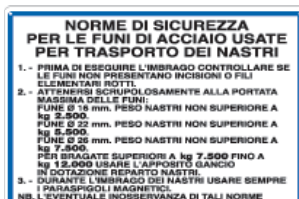

3645

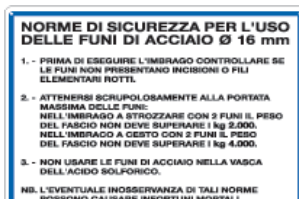

3646

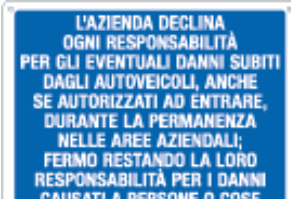

4334



4335



Cartelli per depositi G.P.L. (D.M. 14-05-04 - D.M. 04-03-2014)

LE PRIME DUE CIFRE DEL CODICE IDENTIFICANO LA SERIE, LA PRIMA LETTERA IDENTIFICA IL FORMATO

CODICE	FORMATO	MATERIALE	PREZZO
E38...	400 x 500 mm	Alluminio spessore 0,7 mm	€ 43,80
E103...K	350 x 125 mm	Alluminio spessore 0,5 mm	€ 12,60
E103...KS	350 x 125 mm	Pellicola autoadesiva	€ 7,40
E103...W	550 x 200 mm	Alluminio spessore 0,7 mm	€ 23,60
E103...WS	550 x 200 mm	Pellicola autoadesiva	€ 9,30
E103...X	900 x 330 mm	Alluminio spessore 1 mm	€ 63,80



E3806



E3810



E10301 K KS W WS X

Abbinabili ai cartelli 4807 (pagina 135) e 10201 (pagina 140)



E3811

Picchetto G.P.L. in plastica

Picchetto di perimetro per serbatoio GPL interrato, colore bianco, con puntale. Il picchetto identifica, come da D.M. 14-05-2004 e D.M. 04-03-2014, l'ingombro di un serbatoio GPL interrato. A corredo fornibili catene, anelli e ganci (pag. 299).

PAP4060GPL - picchetto per serbatoi G.P.L., dimensioni Ø mm 40, altezza fuori terra cm 60 (altezza totale cm 87)



Cartelli di messa a terra

LE PRIME DUE CIFRE DEL CODICE IDENTIFICANO IL FORMATO

CODICE	FORMATO	MATERIALE	PREZZO
26..	333 x 500 mm	Alluminio spessore 0,7 mm	€ 22,60
E27..	333 x 500 mm	Alluminio spessore 0,7 mm	€ 31,00
37..	350 x 250 mm	Alluminio spessore 0,5 mm	€ 16,80
73..	125 x 175 mm	Alluminio spessore 0,5 mm	€ 5,40
76..	165 x 250 mm	Alluminio spessore 0,5 mm	€ 7,10

ELEVATA RESISTENZA E DURATA DEI MATERIALI. VEDI CARATTERISTICHE A PAGINA 24.



3780 (V 20.000)



3781 (V 15.000)



3785 (V 20.000)



3786 (V 15.000)



7616



7312



E2791



E2792



E2793



E2794



E2795



2637



7611



7612



2632



7613



2633



7614



2634



7615



2635



7617



ETICHETTE AUTOADESIVE PER IMPIANTI ELETTRICI E APPARECCHI LASER

Etichette per impianti elettrici

Etichette fornite su fogli distributori prefustellati che consentono una rapida e facile applicazione. Ogni foglio raccoglie più etichette dello stesso modello.

DIMENSIONI ETICHETTE

FORMATO A



Etichetta Ø 30 mm, foglio mm 135 x 135 (9 etichette per foglio).

€ 3,30/foglio

FORMATO B



Etichetta Ø 20 mm, foglio mm 140 x 140 (25 etichette per foglio).

€ 3,30/foglio

FORMATO C



Etichetta Ø 12 mm, foglio mm 125 x 125 (49 etichette per foglio).

€ 3,70/foglio



IL/ I PRODOTTO/ I SODDISFA/ NO I REQUISITI PREVISTI DALLA DIRETTIVA EUROPEA 2002/95 (ROHS).



9179 B C



9180 C



9181ABC



9182ABC



9183 C



9184 B C



9185 B



9186 B



9188 B



9189 B C



9190 B C



9191 B C



9192 B



9193 B



9194 B



9195 B



9196 B C



9197 B C



9198 B C



9199 B C

DIMENSIONI ETICHETTE

FORMATO A



Etichetta mm 120 x 57, foglio mm 240 x 57 (2 etichette per foglio).
Minimo ordinabile: 5 fogli/ multipli (10 etichette).

€ 2,60/foglio

FORMATO B



Etichetta mm 57 x 24, foglio mm 240 x 57 (10 etichette per foglio).
Minimo ordinabile: 5 fogli/ multipli (50 etichette).

€ 2,60/foglio



E91511 A B



E91512 A B



E91513 A B



E91514 A B



91520 A B



91510



B

DIMENSIONI ETICHETTE

FORMATO A



Etichette triangolo equilatero lato mm 50, foglio mm 175 x 115 (10 etichette per foglio).

€ 2,60/foglio

FORMATO B



Etichette triangolo equilatero lato mm 22, foglio mm 200 x 85 (30 etichette per foglio).

€ 3,00/foglio

DIMENSIONI ETICHETTE

FORMATO A



Etichette triangolo lato mm 60 + appendice mm 60 x 15, foglio mm 175 x 165 (6 etichette per foglio).

€ 3,30/foglio

FORMATO B



Etichette triangolo lato mm 30 + appendice mm 30 x 7, foglio mm 180 x 100 (12 etichette per foglio).

€ 3,30/foglio

Etichette per apparecchi laser

RIF. NORMATIVO CEI EN 60825-1:1995

Sicurezza apparecchi laser - parte 1: classificazione apparecchiature, prescrizioni e guida per l'utilizzatore

DIMENSIONI ETICHETTE

FORMATO B



Etichette, triangolo lato mm 50, foglio mm 110 x 200 (10 etichette per foglio)

€ 5,50/foglio



Appendice mm 52 x 26, foglio mm 250 x 170 (24 etichette per foglio)

€ 6,50/foglio

FORMATO C



Etichette triangolo lato mm 100, foglio mm 110 x 200 (2 etichette per foglio)

€ 5,50/foglio



Appendice mm 105 x 52, foglio mm 350 x 250 (12 etichette per foglio)

€ 8,20/foglio



E91640 B C



91660 B C



E91630 A B



91631 A B



E91633 A B



91632 A B



E91634 A B



E91650 A B



E91651 A B



E91652 A B



E91653 A B



E91654 A B



E91655 A B



IL/ I PRODOTTO/ I SODDISFA/ NO I REQUISITI PREVISTI DALLA DIRETTIVA EUROPEA 2002/95 (ROHS).



* L'articolo 91650 è in PVC autoadesivo opaco scrivibile. Inoltre è possibile applicare, nell'appendice del formato A, l'etichetta codice E91...C alle pagine 144-145.



ETICHETTE AUTOADESIVE PER IMPIANTI ELETTRICI

Etichette autoadesive per impianti elettrici

Tutte le etichette vengono fornite su fogli distributori prefustellati che consentono una rapida e facile applicazione. Ogni foglio raccoglie più etichette dello stesso modello. Precipare sempre il formato (A-B-C). **Foglio distributore: mm 240 x 60.** Minimo ordinabile: 5 fogli/multipli.



DIMENSIONI ETICHETTE

FORMATO A

380 VOLT

1 etichetta (mm 240 x 60)
per foglio.

€ 3,10/foglio

FORMATO B

380 VOLT 380 VOLT
380 VOLT 380 VOLT

4 etichette (mm 120 x 30)
uguali per foglio.

€ 3,20/foglio

FORMATO C

380 VOLT 380 VOLT 380 VOLT 380 VOLT
380 VOLT 380 VOLT 380 VOLT 380 VOLT
380 VOLT 380 VOLT 380 VOLT 380 VOLT
380 VOLT 380 VOLT 380 VOLT 380 VOLT

16 etichette (mm 60 x 15)
uguali per foglio.

€ 3,50/foglio



IL/ I PRODOTTO/ I SODDISFA/ NO I REQUISITI PREVISTI DALLA DIR. EUROPEA 2002/95 (ROHS).



CODICE DEL CARTELLINO		FORMATI DISPONIBILI	
9 VOLT	9129	12 VOLT	9130
13 VOLT	9139	24 VOLT	9101
42 VOLT	9102	48 VOLT	9103
50 VOLT	9131	60 VOLT	9132
72 VOLT	9136	75 VOLT	9133
110 VOLT	9104	125 VOLT	9105
140 VOLT	9134	160 VOLT	9106
220 VOLT	9107	230 VOLT	9145
275 VOLT	9135	280 VOLT	9108
380 VOLT	9109	220/380 VOLT	9110
400 VOLT	9144	230/400 VOLT	9146
415 VOLT	9147	500 VOLT	9111
2500 VOLT	9140	3000 VOLT	9112
4000 VOLT	9137	5000 VOLT	9138
6000 VOLT	9113	10000 VOLT	9114
11000 VOLT	9142	15000 VOLT	9115
20000 VOLT	9141	23000 VOLT	9116
25000 VOLT	9117	30000 VOLT	9118



ALLARME

9143 A B

EMERGENZA

9124 A B C

FORZA

9120 A B C

GENERALE F.M.

9126 C

GENERALE LUCE

9125 C

LUCE

9119 A B C

LUCE e FORZA

9123 A B C

MONOFASE

9121 A B C

TRIFASE

9122 A B C

TRIFASE + NEUTRO

9127 B C

USI TERMICI

9128 C

Cartellini di avvertimento

Indispensabili per segnalare rapidamente situazioni temporanee di pericolo. Applicati direttamente ai quadri di manovra, ai comandi, agli interruttori, ecc., eliminano il rischio di manovre errate e pericolose. Segnali e simboli nel rispetto del Decreto Legislativo 81 del 09/04/08 Titolo V.

E98.. - cartellini di avvertimento in plastica rigida scrivibile completi di laccino, dimensioni mm 149 x 82. Minimo ordinabile: 20 cartellini/multipli.

€ 6,10



E9801



E9802



E9803



E9804



E9805



E9806



QUESTO TESTO È STAMPATO SUL RETRO DI OGNI CARTELLINO DI AVVERTIMENTO



E9807



E9808



E9809



E9810



E9811



E9812



9813



E9814



E9815



E9816



E9817



E9818



E9819



E9823

i I CARTELLINI DI AVVERTIMENTO OFFRONO UN SISTEMA DI IDENTIFICAZIONE (PER INTERRUPTORI, PORTAFUSIBILI, QUADRI E CONDUTTORI ELETTRICI, TRASFORMATORI ECC.), CHE PERMETTE DI ELIMINARE PERICOLI DI ERRORI O INCIDENTI DURANTE LE RIPARAZIONI, LE INSTALLAZIONI E CONTROLLI DI IMPIANTI ELETTRICI.





CARTELLI AUSILIARI E KIT PER CABINE ELETTRICHE

Cartelli ausiliari singoli per segnali di pericolo



DA ABBINARE AI SEGNALE DI PERICOLO SERIE 11 (VEDI PAGINE 28 E 29).

DIMENSIONI DEI CARTELLI AUSILIARI SINGOLI

CODICE	FORMATO	MATERIALE	PREZZO
121..K	140 x 40 mm	Alluminio spessore 0,5 mm	€ 2,90
121..W	210 x 40 mm	Alluminio spessore 0,5 mm	€ 5,60
122..K	140 x 70 mm	Alluminio spessore 0,5 mm	€ 3,50

CODICE DEL CARTELLINO **FORMATI DISPONIBILI**

220 V 121701 K W	380 V 121702 K W	500 V 121703 K
220-110 V 121704 K	380-110 V 121705 K	500-110 V 121706 K
TENSIONI INTERCONNESSE 121707 K	TENSIONE DI RITORNO 121708 K	IMPIANTO LUCE AD ALIMENTAZIONE AUTONOMA 121709 K
24 V 121710 K W	110 V 121711 KW	48 V 121712 K
12 V 121713 K	400 V 121714 K	230 V 121715 K
 E12273 K	 12275 K	 12276 K

Cartelli ausiliari singoli per segnaletica bordo macchina

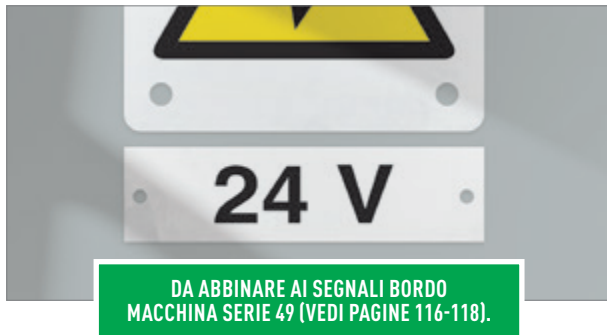

DA ABBINARE AI SEGNALE BORDO MACCHINA SERIE 49 (VEDI PAGINE 116-118).

DIMENSIONI DEI CARTELLI AUSILIARI SINGOLI

CODICE	FORMATO	MATERIALE	PREZZO
49...B *	115 x 30 mm	Alluminio spessore 0,5 mm	€ 9,70
49...C *	60 x 15 mm	Alluminio spessore 0,5 mm	€ 18,80
49...D *	10 x 15 mm	Alluminio spessore 0,5 mm	€ 2,90

24 V 49101 B C	42 V 49102 B C	48 V 49103 B C	
110 V 49104 B C	220 V 49107 B C	380 V 49109 B C	
500 V 49111 B C	3000 V 49112 B C	12 V 49130 B C	
400 V 49144 B C	230 V 49145 B C	415 V 49147 B C	
	 49220 D Ø 4 mm	 49221 D Ø 5 mm	 49222 D Ø 6 mm

* 49...B - min. ordinabile 25 pezzi/multipli
49...C - min. ordinabile 25 pezzi/multipli
49...D - min. ordinabile 100 pezzi/multipli

Kit per cabine elettriche

KIT 15.000V

Kit per cabine elettriche composto da 6 cartelli.

KIT15000 - kit per cabina media tensione 15.000 V

€ 80,80

KIT15000R - kit come sopra ma con E11903X rifrangente

€ 89,20



E11903X



3139



E20150X



10207W



7612



3786

KIT 20.000V

Kit per cabine elettriche composto da 6 cartelli.

KIT20000 - kit per cabina media tensione 20.000 V

€ 80,80

KIT20000R - kit come sopra ma con E11903X rifrangente

€ 89,20



E11903X



3139



E20150X



10207W



7612



3785



DIMENSIONI DEI CARTELLI IN LINGUA STRANIERA



K - 350 x 125



X - 333 x 500

SIGLA FORMATO	DIMENSIONI (b x h)	SPESSORE ALLUMINIO	DISTANZA DI LETTURA	PREZZO
K	350 x 125 mm	0,5 mm	4 metri	€ 11,60
X	333 x 500 mm	0,7 mm	10 metri	€ 35,20

MATERIALI A RICHIESTA

A richiesta, nel formato K, i cartelli sono fornibili anche su supporto autadesivo in confezione da 5 pezzi/multipli per articolo.

I CARTELLI IN LINGUA STRANIERA POSSONO ESSERE REALIZZATI CON SCRITTE DIVERSE (VEDI PAGINA 20).

ELEVATA RESISTENZA E DURATA DEI MATERIALI. VEDI PAGINA 24.



CARTELLI IN INGLESE



NO SMOKING

EYE1801 K X



NO SMOKING AND NO NAKED LIGHTS

EYE1822 K X



DO NOT EXTINGUISH WITH WATER

EYE1823 K X



NO ACCESS FOR UNAUTHORISED PERSONNEL

YE1808 K X



NO ENTRY BEYOND THE SAFETY LIMIT before the voltage has been switched off

YE1820 K



NO PEDESTRIAN ACCESS

EYE1817 K



NO PUSHING

EYE18341 K



NO STEPPING ON SURFACE

EYE18346 K



UNAUTHORISED PERSONS NOT TO USE THIS MACHINE

EYE1839 K



DO NOT OPEN WHILST IN MOTION

EYE1863 K



FORK LIFT TRUCKS PROHIBITED

EYE1826 K



SCAFFOLDING INCOMPLETE DO NOT USE

EYE18349 K



DO NOT OIL OR CLEAN MACHINE WHILST IN MOTION

YE1830 K



DO NOT REMOVE GUARDS

YE1831 K X



DO NOT OPERATE WHILST IN MOTION

EYE1835 K



DO NOT USE LIFT IN THE EVENT OF FIRE

EYE1845 K



DO NOT USE PORTABLE TELEPHONES

EYE18075 K



NO PHOTOGRAPH

EYE18084 K



UNAUTHORISED PERSONS NOT TO USE THIS LIFT

EYE1846 K



NO HEAVY LOADS ON SURFACE

EYE18340 K



NO PACEMAKERS

EYE182801 K



NO ACCESS FOR PEOPLE WITH METALLIC IMPLANTS

EYE182901 K



NO METALLIC ARTICLES OR WATCHES

EYE183001 K



DO NOT TIE KNOTS IN ROPE

EYE18307 K



DO NOT ALTER THE SWITCH

EYE18493 K



DO NOT USE FOR FACE GRINDING

EYE18343 K



DO NOT USE FOR WET GRINDING

EYE18494 K



DO NOT USE WITH HAND-HELD GRINDING MACHINE

EYE18491 K



DO NOT WALK OR STAND HERE

EYE18348 K

CARTELLI IN FRANCESE



DEFENSE DE FUMER

EYF1801 K



ACCES INTERDIT AU PERSONNEL NON AUTORISE

YF1808 K



DEFENSE DE FUMER ET D'ENTRER AVEC UNE FLAMME

EYF1822 K



DEFENSE D'ETEINDRE AVEC DE L'EAU

EYF1823 K X



INTERDIT DE NETTOYER OU MODIFIER EN MARCHÉ

YF1830 K



NE PAS ENLEVER LES PROTECTIONS DE SECURITE

YF1831 K



USAGE INTERDIT AUX PERSONNES NON AUTORISEES

EYF1839 K



NE PAS DEPOSER DE MATERIAUX

EYF18043 K



CARTELLI DI PERICOLO, OBBLIGO E SOSTANZE PERICOLOSE IN LINGUA STRANIERA

DIMENSIONI DEI CARTELLI IN LINGUA STRANIERA



K - 350 x 125



X - 333 x 500

SIGLA FORMATO	DIMENSIONI (b x h)	SPESSORE ALLUMINIO	DISTANZA DI LETTURA	PREZZO EYE17..	PREZZO EYE19..
K	350 x 125 mm	0,5 mm	4 metri	€ 14,60	€ 13,80
X	333 x 500 mm	0,7 mm	10 metri	€ 35,20	€ 34,00

MATERIALI A RICHIESTA

A richiesta, nel formato K, i cartelli sono fornibili anche su supporto autoadesivo in confezione da 5 pezzi/multipli per articolo.



EYE2703



EYE2727

FORNIBILI A RICHIESTA CARTELLI PER SOSTANZE PERICOLOSE IN LINGUA STRANIERA. IN ALLUMINIO SPESSORE 0,7 MM, DIMENSIONI 500 X333 MM. RICHIEDI UN PREVENTIVO!

CARTELLI IN INGLESE



EYE1710 K	EYE1731 K	EYE1746 K	EYE1798 K	EYE1753 K X	EYE1756 K X	EYE1757 K	EYE1759 K
EYE1760 K	EYE172201 K	YE1765 K	EYE17123 K	EYE1715 K	EYE1720 K	EYE1722 K	EYE17133 K
EYE1901 K	EYE1902 K	EYE1903 K	EYE1904 K X	EYE1905 K X	EYE1906 K	EYE1911 K	EYE1961 K
EYE191501 K	EYE1907 K	EYE199101 K	EYE1956 K	EYE192001 K	EYE1921 K		

CARTELLI IN FRANCESE



EYF1731 K	YF1765 K	EYF1798 K	EYF17123 K	EYF1901 K	EYF1904 K	EYF1905 K	EYF1906 K



DIMENSIONI ETICHETTE DI PERICOLO

FORMATO A



Lato etichetta 120 mm, appendice 120 x 33 mm, foglio 250 x 175 mm (2 etichette per foglio).

€ 6,30/foglio

FORMATO B



Lato etichetta 57 mm, appendice 57 x 16 mm, foglio 250 x 80 mm (4 etichette per foglio).

€ 5,10/foglio

DIMENSIONI ETICHETTE DI DIVIETO E OBBLIGO

FORMATO A



Etichetta 125 x 160 mm, simbolo Ø 117 mm foglio mm 250 x 160 mm (2 etichette per foglio).

€ 6,30/foglio

FORMATO B



Etichetta 61 x 80 mm, simbolo Ø 57 mm foglio mm 250 x 80 mm (4 etichette per foglio).

€ 5,10/foglio

ETICHETTE IN INGLESE



 FLAMMABLE EYE95251	 EXPLOSIVE EYE95252	 CORROSIVE EYE95253	 TOXIC EYE95254	 WARNING EYE95257
 HIGH TENSION EYE95259	 ELECTRIC SHOCK RISK EYE95262	 DANGER EYE95263	 WARNING HOT SURFACE EYE95271	 WARNING Noise level above 85 dB(A) YE95272
 WARNING MOVING MACHINERY YE95274	 WARNING ANTISTATIC DEVICE YE95291	 MIND YOUR HANDS EYE95260	 DANGER LASER HAZARD EYE95292	
 NO SMOKING EYE95201	 DO NOT EXTINGUISH WITH WATER EYE95202	 DO NOT REPAIR OR ADJUST MACHINE WHILST IN MOTION YE95203	 DO NOT OIL OR CLEAN MACHINE WHILST IN MOTION YE95205	 NO ADMITTANCE EYE95206
 DO NOT REMOVE SAFETY DEVICES YE95208	 DO NOT OPERATE BEFORE SWITCH OFF ELECTRICAL SUPPLY EYE95209	 DO NOT OPEN BEFORE SWITCH OFF ELECTRICAL SUPPLY EYE95210	 UNAUTHORISED PERSONS NOT TO USE THIS MACHINE EYE95213	 NO ENTRY TO UNAUTHORISED YE95217
 WEAR GLOVES EYE95231	 WEAR GOGGLES EYE95232	 WEAR HELMET EYE95233	 WEAR RESPIRATOR EYE95234	 WEAR EAR PROTECTION EYE95235
 WEAR BOOTS EYE95236	 WEAR PROTECTIVE CLOTHING EYE95237	 SWITCH OFF BEFORE TO OPERATE EYE95239	 WEAR FACE SHIELD EYE95242	

ETICHETTE IN FRANCESE



 ATTENTION EYF95257	 HAUTE TENSION EYF95259	 DANGER ELECTRIQUE EYF95262
 ATTENTION A VOS MAINS EYF95260	 DANGER SURFACE CHAUDE EYF95271	 ATTENTION Zone de bruit > 85 dB(A) YF95272
 ATTENTION MACHINE EN MOUVEMENT YF95274	 ATTENTION APPAREIL ANTI-STATIQUE YF95291	
 DEFENSE DE FUMER EYF95201	 INTERDIT DE REPARER LA MACHINE YF95203	 INTERDIT DE NETTOYER OU DE REPARER LA MACHINE YF95205
 NE PAS ENLEVER LES PROTECTIONS DE SECURITE YF95208	 NE PAS UTILISER avant d'avoir coupé le secteur EYF95209	 NE PAS OUVRIIR avant d'avoir coupé le secteur EYF95210
 GANTS OBLIGATOIRES EYF95231	 ACRES INTERDIT AUX PERSONNES NON AUTORISEES YF95217	 GANTS OBLIGATOIRES EYF95231
 LUNETTES OBLIGATOIRES EYF95232	 CASQUES OBLIGATOIRES EYF95233	 PROTECTION ANTI-BRUIT OBLIGATOIRE EYF95235



Luminescente **CARTLUX** DIN PLUS (vedi caratteristiche a pagina 84)

DIMENSIONI DEI CARTELLI LUMINESCENTI CARTLUX® DIN PLUS IN INGLESE



CODICE	DIMENSIONI (b x h)	DISTANZA DI LETTURA	PREZZO ALLUMINIO PIANO (A)	PREZZO PVC RIGIDO (P)	PREZZO PELLICOLA ADESIVA (S)
EL15...K	120 x 120 mm	4 metri	€ 12,60	€ 9,70	€ 9,70
EL15...W	160 x 160 mm	6 metri	€ 16,10	€ 11,80	€ 11,80
EL15...X	250 x 250 mm	10 metri	€ 32,30	€ 26,00	-
YEL16...W	220 x 100 mm	6 metri	€ 16,10	€ 12,60	€ 12,60
YEL16...X	370 x 170 mm	10 metri	€ 35,00	€ 28,00	-
YEL20...X	250 x 310 mm	10 metri	€ 39,00	€ 31,00	-

MATERIALI

I cartelli sono fornibili in:

- **Alluminio**, aggiungendo "A" dopo la lettera formato (es. YEL16138WA);
- **PVC rigido**, aggiungendo "P" dopo la lettera formato (es. YEL16138WP).
- **Pellicola autoadesiva**, aggiungendo "S" dopo la lettera formato (es. YEL16138WS). Solo nei formati K e W (confezioni da 5 pezzi per articolo)

DIMENSIONI DEI CARTELLI DI SICUREZZA IN INGLESE



CODICE	DIMENSIONI (b x h)	DISTANZA DI LETTURA	PREZZO ALLUMINIO PIANO (A)	PREZZO PVC RIGIDO (P)	PREZZO PELLICOLA ADESIVA (S)
E15...K	120 x 120 mm	4 metri	€ 5,60	€ 9,70	€ 9,70
E15...W	160 x 160 mm	6 metri	€ 5,60	€ 11,80	€ 11,80
E15...X	250 x 250 mm	10 metri	€ 7,10	€ 26,00	-
YE16...W	220 x 100 mm	6 metri	-	€ 12,60	€ 12,60
YE16...X	370 x 170 mm	10 metri	€ 13,60	€ 28,00	-
YE20...K	120 x 145 mm	4 metri	€ 11,00	€ 31,00	-
YE20...X	250 x 310 mm	10 metri	€ 14,40	€ 31,00	-

MATERIALI

I cartelli sono fornibili in:

- **Alluminio**, aggiungendo "A" dopo la lettera formato (es. YE16120WA);
- **PVC rigido**, aggiungendo "P" dopo la lettera formato (es. YE16120WP).
- **Pellicola autoadesiva**, aggiungendo "S" dopo la lettera formato (es. EYE20103KS). Solo nei formati K e W (confezioni da 5 pezzi per articolo)

 EMERGENCY SHOWER EYE20103 K	 EYEWASH EYE20104 K	 EMERGENCY EXIT EYE20105 K X	 EMERGENCY EXIT EYE20106 K X	 EMERGENCY ASSEMBLY POINT EYE20153 K	 EMERGENCY WINDOW WITH ESCAPE LADDER EYE201601 K	 IN CASE OF EMERGENCY BREAK GLASS EYE200801 K
 DRY POWDER EXTINGUISHER EYE20124 X	 CO ₂ EXTINGUISHER EYE20126 X	 MOBILE UNIT EYE20152 X	 FIRE HOSE REEL EYE20165 X	 FIRE EXTINGUISHER EYE20118 K X	 FIRE FIGHTING EQUIPMENT EYE20119 K X	 FIRE ALARM CALL POINT EYE20174 K X

 EMERGENCY EXIT YEL16124 X	 ANTIPANIC DOOR HANDLE push to open YEL16138 W	 PUSH TO OPEN YEL16139 X
 EL15104 KW X	 IN CASE OF FIRE DON'T USE THE LIFT EYEL16135 W	 FIRE FIGHTING EQUIPMENT YEL16101 X
 EL15105 KW X	 EMERGENCY EXIT EYEL20105 X	 EMERGENCY EXIT EYEL20106 X
 EMERGENCY ASSEMBLY POINT EYEL20153 X	 FIRE LADDER EYEL20159 X	 FIRE FIGHTING EQUIPMENT EYEL20119 X
 FIRE EXTINGUISHER EYEL20150 X	 FIRE HOSE REEL EYEL20165 X	 FIRE ALARM CALL POINT EYEL20174 X

SEGNALETICA AZIENDALE E PER PROPRIETÀ PRIVATA

SEGNALETICA ATTACCA-STACCA	153
ETICHETTE E CARTELLI DI INDICAZIONE PER INTERNI.....	154-156
CARTELLI DI INDICAZIONE IN ALLUMINIO SPECCHIATO	156
CARTELLI DI INFORMAZIONE SERIE "QUALITÀ"	157
SEGNALETICA PER AREE PRIVATE, PARCHEGGI E VARIA.....	158-163
CARTELLO QUADRIFACCIALE, DOG PARKING.....	163
SEGNALETICA DI SENSIBILIZZAZIONE SOCIALE.....	163
SEGNALETICA PER VIDEOSORVEGLIANZA.....	164
SEGNALETICA PER RISERVE E DIVIETI, C.E.R.....	165
SEGNALETICA PER AREE VERDI.....	166
SEGNALETICA PER RACCOLTA RIFIUTI	167
SEGNALETICA ADESIVA "A MEZZALUNA"	167
SEGNALETICA DI INDICAZIONE PER MAGAZZINI.....	168
SEGNALETICA "ATTENTI AL CANE"	169
SEGNALETICA PER ESERCIZI COMMERCIALI.....	170
ETICHETTE CONTROLLO QUALITÀ	171
SEGNALETICA PER INTERNI IN LINGUA STRANIERA.....	171



GUIDA ALLA SCELTA DEI MATERIALI

I segnali di nostra produzione sono costruiti nei materiali indicati all'inizio di ogni gruppo di cartelli. Le dimensioni e le caratteristiche cromatiche e colorimetriche dei segnali sono conformi a quanto prescritto dalle norme UNI 7543, ISO 7010 cui fa riferimento il D. Lgs. 81 del 09/04/08 Titolo V. Tolleranza massima dei materiali -0 +3 mm (norma UNI EN 485-4). Tolleranza distanza di lettura della simbologia: ± 2%.

I NOSTRI SEGNALI HANNO UN'ELEVATA RESISTENZA E DURATA NEL TEMPO, GRAZIE ALLE CARATTERISTICHE DELLA STAMPA E DEI MATERIALI.



I COLORI UTILIZZATI NEI CARTELLI SONO SIMILI AI SEGUENTI RAL:

- GIALLO (RAL 1023)
- ROSSO (RAL 3020)
- BLU (RAL 5017)
- VERDE (RAL 6024)
- BIANCO (RAL 9010)
- NERO (RAL 9011)



ALLUMINIO PIANO

Adatto in ambienti esterni ed interni con atmosfera anche molto aggressiva, e debolmente corrosiva. Buona resistenza ai solventi.

Spessori da 0,5 a 1 mm (indicati all'inizio di ogni gruppo di cartelli). Tolleranze dimensionali secondo Norma UNI EN 485-4. Lamiera di alluminio lega EN AW-3105 o, in alternativa, EN AW-5005 (composizione chimica in accordo alla Norma UNI EN573-3), stato fisico da H42 a H48 (caratteristiche meccaniche in accordo alla Norma UNI EN1396) in funzione degli spessori, verniciata sul primo lato con film poliuretano, ottenuta con il seguente ciclo:

1 Sgrassaggio - 2 Risciacquo/lavaggio - 3 Pretrattamento esente da cromo - 4 Passivazione - 5 Mano di vernice poliuretano a finire nel colore di fondo e mano di trasparente poliuretano protettivo sul retro e relativa cottura - 6 Stampa dei segnali, dei simboli e delle scritte - 7 Definitiva cottura a forno

Prove di invecchiamento

Come previsto dalla norma UNI7543-1 punto 13, campioni rappresentativi dei segnali sono stati sottoposti ad una prova di invecchiamento artificiale che verifichi la durata della superficie del segnale nel tempo.

ALLUMINIO E LAMIERA SCATOLATA

Adatto in ambienti esterni ed interni con atmosfera normale.

Cartelli in lamiera o alluminio scatoletti con attacchi sul retro, per applicazione a palo mediante collari (per caratteristiche costruttive vedi la sezione Segnaletica Stradale).



RIFRANGENTE (CLASSE 1)

Adatto in ambienti esterni ed interni con atmosfera anche aggressiva.

Per ambienti con cattiva illuminazione; pellicola retroriflettente a superficie liscia, autoadesiva su supporto di alluminio con caratteristiche cromatiche conformi alla Norma UNI7543.

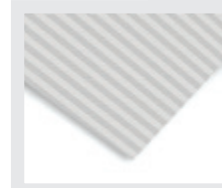

PVC AUTOADESIVO

Adatto in ambienti esterni ed interni con atmosfera normale.

Film di vinile plastificato adesivizzato, con buona resistenza all'invecchiamento, agli agenti atmosferici, agli agenti chimici, (acidi, basi, alcool). Stampa con inchiostri resistenti ai raggi ultravioletti.



PVC RIGIDO

Adatto in ambienti esterni ed interni con atmosfera aggressiva e corrosiva ma con limitate escursioni termiche.

Spessori da 0,5, 1 o 1,5 mm. Lastra in PVC estruso, colore stabilizzato e trattato contro gli agenti atmosferici, stampa con inchiostri resistenti ai raggi ultravioletti. Ottime caratteristiche dielettriche, autoestinguente.



ATTACCA-STACCA (PAG. 153)

Adatto per qualsiasi superficie liscia (vetro, legno, plastica, metallo)

Etichetta in pet con pellicola autoadesiva senza colla, dotata di microventose che consentono al segnale di essere attaccato e staccato più volte senza residui sulle superfici (simil Post-it con adesività su tutta la superficie) e senza effetti negativi sull'adesività.



SEGNALETICA ATTACCA STACCA

La segnaletica in versione attacca-stacca è senza adesivo, dotata di microventose che consentono al segnale di essere **attaccato e staccato più volte** senza residui sulle superfici (simil post-it con adesività su tutta la superficie) e senza effetti negativi sull'adesività. Può essere applicato **su qualsiasi superficie liscia**. Provalo su vetro, legno, plastica e metallo!



VETRO



METALLO

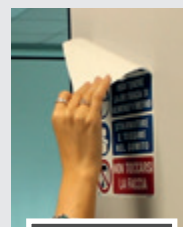

PLASTICA



LEGNO

PERCHÈ SCEGLIERLA?

Utilissima quando i messaggi hanno durata limitata nel tempo, la loro sostituzione risulta semplice ed evita perdite di tempo per pulire i residui di colla. Le microventose consentono di applicare, rimuovere e sostituire il messaggio infinite volte senza effetti negativi sull'adesività.

Vantaggi del prodotto:

- Applicazione priva di colla, senza bolle, ideale sia per interni che esterni
- Possibilità di aggiornare il look del tuo locale in poche semplici mosse: grafiche intercambiabili per negozi, spazi espositivi e interni. Ideale su specchi, vetrine e vetri.
- Spazi pubblicitari temporanei, riposizionabile infinite volte.
- In materiali riciclabili.
- Lavabile.

SETTORE DI APPLICAZIONE:

- NEGOZI E LOCALI (VETRINE, PARETI, CAMERINI)
- SPAZI ESPOSITIVI
- SPAZI DI COWORKING
- SALE RIUNIONI
- UFFICI
- SPAZI PUBBLICITARI TEMPORANEI

MICROVENTOSE

LA SOLUZIONE IDEALE PER QUALSIASI NECESSITÀ!

Versione biadesiva: per appendere le tue stampe e rimuoverle con facilità senza residui (simil Patafix)

Per carrozzerie: l'unico adesivo per auto senza colla. Non danneggia le carrozzerie, resiste alle alte velocità fino a 130 km/h, alle intemperie e agli sbalzi di temperatura

Lavagna attacca-stacca scrivibile: ideale per uffici e spazi di coworking. Contro gli sprechi di carta durante i brainstorming o per annotare programmi di lavoro. Facile da usare, possibilità di scrivere, cancellare e riscrivere.

Lavagna magnetica: film magnetici riscrivibili autoadesivi per applicazione su pareti. Ideale per scuole, uffici e asili nido. A RICHIESTA versione proiettabile per presentazioni dinamiche, seminari e conferenze.

Lavagna ferrosa: film ferrosi riscrivibili autoadesivi per l'applicazione di prodotti magnetici.

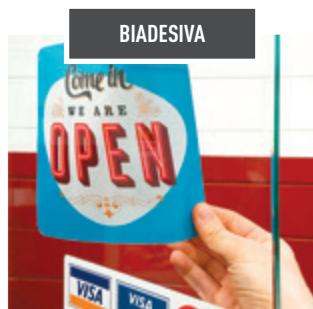

BIADESIVA



PER CARROZZERIE



SCRIVIBILE



CANCELLABILE



Etichette d'indicazione

DIMENSIONI DELLE ETICHETTE DI INDICAZIONE

FORMATO	DIMENSIONI	MATERIALE	COLORE	PREZZO
A	165 x 165 mm	Pellicola autoadesiva spessore 0,3	Colore argento opaco, stampa blu	€ 9,10
B	82 x 82 mm			€ 3,90

CODICE DEL CARTELLO
FORMATI DISPONIBILI



ESEMPI DI APPLICAZIONE SEGNALE + FRECCIA



ELEVATA RESISTENZA E DURATA DEI MATERIALI. VEDI A PAGINA 152.

Cartelli d'indicazione

LE PRIME DUE CIFRE DEL CODICE IDENTIFICANO IL FORMATO

CODICE	DIMENSIONI (b x h)	FORMATO	SPESSORE	PREZZO ALLUMINIO PIANO
13..	115 x 115 mm	K	0,5 mm	€ 5,40
13..	270 x 270 mm	X	0,5 mm	€ 12,20
13..	435 x 435 mm	Y	0,7 mm	€ 40,40
15...	120 x 120 mm	K	0,5 mm	€ 5,60
15...	160 x 160 mm	W	0,5 mm	€ 5,60
15...	250 x 250 mm	X	0,5 mm	€ 7,10
20...	120 x 145 mm	K	0,5 mm	€ 5,90
56...	300 x 450 mm	X	0,7 mm	€ 22,80

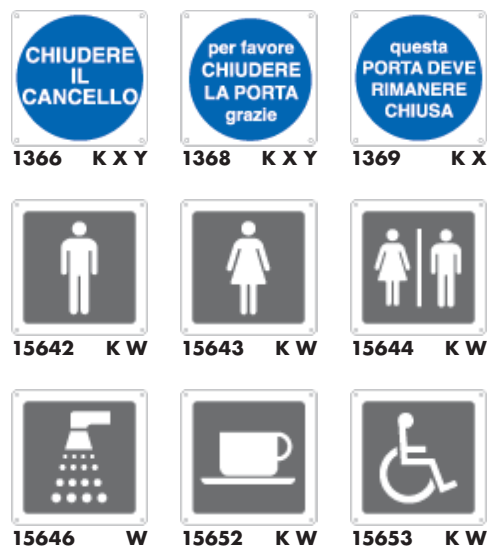

LE FRECCIE INDICANTI LA DIREZIONE VENGONO FORNITE IN MATERIALE AUTOADESIVO DA APPLICARE. NON È QUINDI NECESSARIO INDICARE LA DIREZIONE.



* Simboli previsti dal D.P.R. n° 503 del 24/7/96



Etichette per interni

DIMENSIONI DELLE ETICHETTE PER INTERNI

CODICE	DIMENSIONI	MATERIALE	COLORE	PREZZO
96...	165 x 50 mm	Pellicola autoadesiva spessore 0,3	Colore argento opaco, stampa blu	€ 4,90

ESEMPI DI APPLICAZIONE SEGNALE + FRECCIA



96600 (150 x 50 mm)



96601



96660



96679



96680



96681



96682



96683



96684



96780



96781



96693



96694



96666



96662



96784



96785



96786



96787



96788



96789



96790



96665



96697



96698



96661



96663



96667



96668



96678



96685



96669



96676



96691



96687



96688



96689



96692



96699



96696



96664



96690



96674



96673



96675



96701



96702



96703



96671



96672



96670



96782



96783

Etichette per interni

€ 4,30/foglio

Foglio distributore: mm 240 x 85. Minimo ordinabile: 5 fogli/multipli. Colori disponibili: **B** blu **G** verde

FORMATO A



1 ETICHETTA MM 240 X 85



9601

A B



9602

A B



9603

A B



9604

A B



9605

A B



9606

A B

FORMATO B



4 ETICHETTE MM 120 X 42,5



9607

A B



9608

A B



CARTELLI D'INDICAZIONE PER INTERNI IN ALLUMINIO E ALLUMINIO SPECCHIATO

Cartelli per interni

LE PRIME DUE CIFRE DEL CODICE IDENTIFICANO IL FORMATO

CODICE	FORMATO	MATERIALE	PREZZO
25..	350 x 125 mm	Alluminio spessore 0,5 mm	€ 9,30
30..	125 x 125 mm	Alluminio spessore 0,5 mm	€ 4,80



30 00



30 05



2501



2502



2503



2504



2505



2506



2507



2553



2554



2508



2509



2510



2511



2512



2513



2514



2515



2516



2517



2518



2519



2520



2521



2522



2523



2524



2525



2526



2527



2551



2552



ELEVATA RESISTENZA E DURATA DEI MATERIALI. VEDI A PAGINA 152.

Cartelli in alluminio specchiato

LE PRIME DUE CIFRE DEL CODICE IDENTIFICANO IL FORMATO

CODICE	FORMATO	MATERIALE	PREZZO
EF70...	200 x 45 mm	Alluminio specchiato spessore 1 mm	€ 13,80



EF70210



EF70212

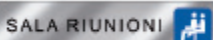

EF70204



EF70206

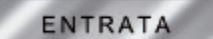

EF70207

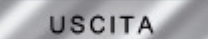

EF70209



EF70215



EF70217



EF70218



EF70219



EF70222

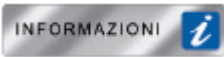

EF70223



EF70225

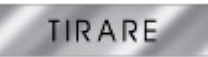

EF70226



EF70227



EF70230



EF70238



EEF70241

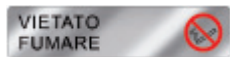

EEF70243



EF70247



EF70249



EF70252



LE PRIME DUE CIFRE DEL CODICE IDENTIFICANO IL FORMATO

CODICE	FORMATO	MATERIALE	PREZZO
23..	350 x 125 mm	Alluminio sp. 0,5	€ 8,80
26..	500 x 333 mm	Alluminio sp. 0,7	€ 22,60
45..	700 x 500 mm	Alluminio sp. 1	€ 71,40



2667



2668



2669



2670



2671



2672



2673



2674



2675



2676



2677



2678



2679



2680



2681



2682



4562

2683



2684



2685



2686



2687



4557

2688



2689

4559



2690



2691

4561



2692



2693



2694



2695



2696



2697



2698



2699



2360



2361



2362



2363



2364



2365



2366



2367



2368



CARTELLI PER PROPRIETÀ PRIVATA

LE PRIME DUE CIFRE DEL CODICE IDENTIFICANO LA SERIE, LA PRIMA LETTERA IL FORMATO

CODICE	MATERIALE	SIGLA FORMATO	FORMATO	SPESSORE
56..	Alluminio	K	200 x 300 mm	0,5 mm
		X	300 x 450 mm	0,7 mm
		Y	400 x 600 mm	0,7 mm
		Z	600 x 900 mm	1 mm
R56..	Alluminio con pellicola rifrangente	W	250 x 450 mm	0,5 mm
		Y	400 x 600 mm	0,7 mm
FL56..	Lamiera sciolata	K	200 x 300 mm	1 mm
		Y	400 x 600 mm	1 mm
		Z	600 x 900 mm	1 mm
FLR56..	Lamiera sciolata con pellicola rifrangente	K	200 x 300 mm	1 mm
		Y	400 x 600 mm	1 mm
		Z	600 x 900 mm	1 mm
FA56..	Alluminio sciolato	K	200 x 300 mm	2,5 mm
		Y	400 x 600 mm	2,5 mm
		Z	600 x 900 mm	2,5 mm
FAR56..	Alluminio sciolato con pellicola rifrangente	K	200 x 300 mm	2,5 mm
		Y	400 x 600 mm	2,5 mm
		Z	600 x 900 mm	2,5 mm

MATERIALI

CODICE	DESCRIZIONE MATERIALE
FL...	Lamiera sciolata, pellicola normale
FLR...	Lamiera sciolata, pellicola rifrangente CE (classe RA1)
FA...	Alluminio sciolato, pellicola normale
FAR...	Alluminio sciolato, pellicola rifrangente CE (classe RA1)

Tutti i segnali sono disponibili in alluminio piano, lamiera sciolata o alluminio sciolato nei formati indicati dalle lettere sotto ogni articolo. Gli spessori del materiale usato sono indicati in tabella. I segnali realizzati in lamiera o alluminio sciolato sono provvisti di supporti per attacco a palo.



ELEVATA RESISTENZA E DURATA DEI MATERIALI. PER LE CARATTERISTICHE COMPLETE DEI MATERIALI VEDI PAGINA 152.

! PER CARTELLI DI PROPRIETÀ PRIVATA SI INTENDONO CARTELLI PER AREE PRIVATE NON APERTE AL PUBBLICO.

SE TRA LA GAMMA DI CODICI PRESENTI NELLA PAGINA NON TROVI IL CARTELLO CHE CERCHI, VAI A PAGINA 20.

CODICE DEL CARTELLO **FORMATI DISPONIBILI**



♦ Solo rifrangente. Nel rettangolo specificare numero e anno del rilascio dell'autorizzazione.



5682 K Y

spazio neutro



5683 K Y

**DIVIETO DI
CAMPEGGIO**
RIMOZIONE FORZATA
PER I TRASGRESSORI



56610 K Y

**DIVIETO
DI SOSTA**
ANCHE DI NOTTE



5671 Y

Per
dalle ore
del
alle ore
del



5637 K X

PROPRIETÀ PRIVATA
LASCIARE
LIBERO
IL PASSAGGIO



5638 K X Y

VIETATO FERMARSI
LASCIARE
LIBERO
IL PASSAGGIO



5639 X Y

ENTRATA E USCITA
VEICOLI



5674 K Y

divieto di fermata
**CANCELLO
AUTOMATICO**



5684 K Y

spazio neutro



R5601/./ (km/h) Y Z

15
VELOCITÀ
MASSIMA
CONSENTITA



5619 Y

**STRADA
SENZA
USCITA**



5640 Y

EVITARE
RUMORI INUTILI
GRAZIE!



56110 Y

NON TENERE ACCESO
IL MOTORE
OLTRE IL NECESSARIO



5609 K X Y

PROPRIETÀ
PRIVATA
DIVIETO
DI TRANSITO



5610 Y

CIRCOLAZIONE
VIETATA
A PERSONE E MEZZI
NON AUTORIZZATI



5611 Y

STRADA
CHIUSA
AL TRAFFICO



56111 K Y

PASSAGGIO
PEDONALE



5681 K Y

spazio neutro



5641 Y

VIETATO
L'ACCESSO
A TUTTI GLI
AUTOVEICOLI



5612 X Y

PROPRIETÀ PRIVATA
VIETATO L'ACCESSO
ALLE PERSONE
NON AUTORIZZATE



5613 K X Y

PROPRIETÀ
PRIVATA
VIETATO L'ACCESSO



5614 Y

STRADA
PRIVATA
VIETATO L'ACCESSO



5615 X Y

VIETATO
L'ACCESSO
AGLI AUTOVEICOLI
A G.P.L.



5616 X Y

VIETATO
L'ACCESSO
AI MEZZI
NON AUTORIZZATI



■ Solo rifrangente. Specificare velocità richiesta.



CARTELLI PER PROPRIETÀ PRIVATA

LE PRIME DUE CIFRE DEL CODICE IDENTIFICANO LA SERIE, LA PRIMA LETTERA IL FORMATO

CODICE	MATERIALE	SIGLA FORMATO	FORMATO	SPESSORE
56..	Alluminio	K	200 x 300 mm	0,5 mm
		X	300 x 450 mm	0,7 mm
		Y	400 x 600 mm	0,7 mm
		Z	600 x 900 mm	1 mm
R56..	Alluminio con pellicola rifrangente	W	250 x 450 mm	0,5 mm
		Y	400 x 600 mm	0,7 mm
FL56..	Lamiera sciolata	K	200 x 300 mm	1 mm
		Y	400 x 600 mm	1 mm
		Z	600 x 900 mm	1 mm
FLR56..	Lamiera sciolata con pellicola rifrangente	K	200 x 300 mm	1 mm
		Y	400 x 600 mm	1 mm
		Z	600 x 900 mm	1 mm
FA56..	Alluminio sciolato	K	200 x 300 mm	2,5 mm
		Y	400 x 600 mm	2,5 mm
		Z	600 x 900 mm	2,5 mm
FAR56..	Alluminio sciolato con pellicola rifrangente	K	200 x 300 mm	2,5 mm
		Y	400 x 600 mm	2,5 mm
		Z	600 x 900 mm	2,5 mm

MATERIALI

CODICE	DESCRIZIONE MATERIALE
FL...	Lamiera sciolata, pellicola normale
FLR...	Lamiera sciolata, pellicola rifrangente CE (classe RA1)
FA...	Alluminio sciolato, pellicola normale
FAR...	Alluminio sciolato, pellicola rifrangente CE (classe RA1)

Tutti i segnali sono disponibili in alluminio piano, lamiera sciolata o alluminio sciolato nei formati indicati dalle lettere sotto ogni articolo. Gli spessori del materiale usato sono indicati in tabella. I segnali realizzati in lamiera o alluminio sciolato sono provvisti di supporti per attacco a palo.



ELEVATA RESISTENZA E DURATA DEI MATERIALI. PER LE CARATTERISTICHE COMPLETE DEI MATERIALI VEDI PAGINA 152.

! PER CARTELLI DI PROPRIETÀ PRIVATA SI INTENDONO CARTELLI PER AREE PRIVATE NON APERTE AL PUBBLICO.

SE TRA LA GAMMA DI CODICI PRESENTI NELLA PAGINA NON TROVI IL CARTELLO CHE CERCHI, VAI A PAGINA 20.

CODICE DEL CARTELLO **FORMATI DISPONIBILI**

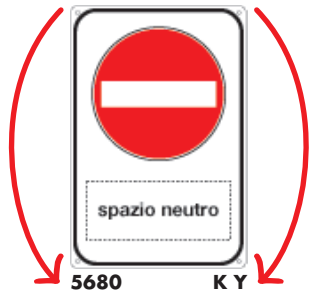



5662 Z



56114 K



56170 Y



56182 Y



56698 Y



56675 K Y



56676 K Y



56679 K Y



56113 X



5646 X Y



5647 X Y



5648 XY



5649 X Y



5667 Y



5617 Y



5685 Y



5690 Y



E5668 Y



5686 Y



5689 X Y



56115 X Y



5697 Y



5698 Y



5699 Y



56318 Y



56328 Y



56378 Y



56388 Y





CARTELLI PER PROPRIETÀ PRIVATA

LE PRIME DUE CIFRE DEL CODICE IDENTIFICANO IL FORMATO

CODICE	FORMATO	MATERIALE	PREZZO
21..	350 x 125 mm	Alluminio spessore 0,5 mm	€ 8,30
E2911	500 x 333 mm	Alluminio spessore 0,7 mm	€ 23,60
35..	300 x 200 mm	Alluminio spessore 0,5 mm	€ 10,00
E35..	300 x 200 mm	Alluminio spessore 0,5 mm	€ 10,00
35.. S	200 x 300 mm	Pellicola autoadesiva	€ 8,00
56...H	450 x 300 mm	Alluminio spessore 0,7 mm	
56...J *	600 x 400 mm	Alluminio spessore 0,7 mm	
56...Q	900 x 600 mm	Alluminio spessore 1 mm	
FL56...J *	600 x 400 mm	Lamiera scatoletta spessore 1 mm	
FL56...Q *	900 x 600 mm	Lamiera scatoletta spessore 1 mm	
FA56...J *	600 x 400 mm	Alluminio scatoletta spessore 2,5 mm	
FA56...Q	900 x 600 mm	Alluminio scatoletta spessore 2,5 mm	

MATERIALI

CODICE	DESCRIZIONE MATERIALE
FL...	Lamiera scatoletta, pellicola normale
FLR...	Lamiera scatoletta, pellicola rifrangente C€ (classe RA1)
FA...	Alluminio scatoletta, pellicola normale
FAR...	Alluminio scatoletta, pellicola rifrangente C€ (classe RA1)

Segnali disponibili in alluminio piano, lamiera scatoletta o alluminio scatoletta nei formati indicati dalle lettere sotto ogni articolo. Gli asterischi riportati in tabella e posti a fianco di alcune lettere, indicano la possibilità di esecuzione di quei formati con pellicola rifrangente E.G. marcato (classe 1). Per la realizzazione con pellicola rifrangente, aggiungere il prefisso R, FLR e FAR rispettivamente per alluminio piano, lamiera scatoletta ed alluminio scatoletta. I segnali realizzati in lamiera o alluminio scatoletta sono provvisti di supporti per attacco a palo.

* R 56.. / FLR 56.. / FAR 56.. = esecuzione con pellicola rifrangente.

CODICE DEL CARTELLO
FORMATI DISPONIBILI

DIVIETO DI SCARICO

5650 H J

DIVIETO DI SCARICO MATERIALI
i trasgressori saranno puniti a norma di legge

5651 H J

È VIETATO GETTARE IN ACQUA RIFIUTI LIQUIDI E SOLIDI DI QUALSIASI GENERE
I TRASGRESSORI SARANNO PUNITI A NORMA DI LEGGE

5652 H

NON CALPESTARE LE AIUOLE

5653 H

AVVICINARSI ALLA SBARRA PER USCIRE

56116 J

STRADA PRIVATA

5654 H

PROPRIETÀ PRIVATA

5655 H J

SI RICORDA ALLA GENTILE CLIENTELA CHE IL PARCHEGGIO NON È CUSTODITO. SI INVITA PERTANTO A NON LASCIARE NELL'AUTO DOCUMENTI E OGGETTI DI VALORE. LA DIREZIONE NON RISponderà DI EVENTUALI FURTI O DANNI ALLE AUTOVEETURE.

5677 H

ALT FARSÌ RICONOSCERE ZONA MILITARE

5656 J

LIMITE INVALIDICABILE ZONA MILITARE
VIGILANZA ARMATA

5657 J

LIMITE INVALIDICABILE ATTENZIONE
VIGILANZA ARMATA

5663 J

ALT FARSÌ RICONOSCERE

5664 J

PASSAGGIO PEDONALE SUL LATO OPPOSTO

5672 J

PASSAGGIO PEDONALE SUL LATO OPPOSTO

5673 J

AI PUNTI DI RACCOLTA

5658 J Q

AI PUNTI DI RACCOLTA

5659 J Q

USCITA DI EMERGENZA LASCIARE LIBERO IL PASSAGGIO

DIVIETO DI SOSTA E FERMATA

E3520

P PARCHEGGIO PRIVATO
RISERVATO AI CLIENTI E CONDOMINI

3522

LASCIARE LIBERO IL PASSAGGIO

USCITA DI EMERGENZA

E3525

DIVIETO DI SOSTA

USCITA DI EMERGENZA

E3546



3524



3565 3565 S

SE TRA LA GAMMA DI CODICI PRESENTI NELLA PAGINA NON TROVI IL CARTELLO CHE CERCHI, VAI A PAGINA 20.



E2911



2191



2192



35201



2193



1 CARTELLO "DOGPARKING"

In lamiera sciolata spessore 1 mm, completo di 3 moschettoni e kit di montaggio per affissione a muro o a palo.

FL5687X - cartello "Dogparking", dimensioni 400 x 300 mm



2



3



4



5



A

CARTELLI QUADRIFACCIALI

Cartelli quadrifacciali premontati in alluminio 0,7 mm con staffa per palo Ø mm 60.

2 CUE20153 - punto di raccolta, mm 400 x 500

3 CU20170 - idrante soprassuolo, mm 400 x 500

4 CUE15180 - punto di raccolta, mm 400 x 400

5 STAFFE PER TABELLE SCATOLATE

Con bulloneria per il montaggio di 4 tabelle scatolate (A), da catalogo o speciali a richiesta, larghezza massima mm 400.

CUEKIT48 - kit staffe per palo da Ø mm 48

CUEKIT60 - kit staffe per palo da Ø mm 60



CARTELLI PER VIDEOSORVEGLIANZA

Nuovo GDPR Regolamento Generale relativo alla Protezione dei Dati Personali (UE) 2016/679.

È stato pubblicato il testo del Decreto Legislativo 30 giugno 2003, n.196, integrato dalle modifiche del Decreto Legislativo di agosto 2018, n.101, recante le disposizioni per l'adeguamento della normativa nazionale alle disposizioni del regolamento (UE) 2016/679 relativo alla protezione e al trattamento dei dati personali da tutti chiamato GDPR. Successivamente il 29/01/2020 sono state adottate le linee guida 3/2019 sul trattamento dei dati personali attraverso dispositivi video. Tutti i cartelli presenti in questa pagina rispettano i requisiti minimi delle Linee guida 3/2019.

LE PRIME DUE CIFRE DEL CODICE IDENTIFICANO LA SERIE, LA PRIMA LETTERA IDENTIFICA IL FORMATO

CODICE	FORMATO	MATERIALE	PREZZO
21..	350 x 125 mm	Alluminio spessore 0,5 mm	€ 8,30
21.. S	350 x 125 mm	Pellicola autoadesiva	€ 5,40
22..	120 x 180 mm	Alluminio spessore 0,5 mm	€ 5,60
22.. S	120 x 180 mm	Pellicola autoadesiva	€ 4,60
27...	333 x 500 mm	Alluminio spessore 0,7 mm	€ 31,00
33..	300 x 200 mm	Alluminio spessore 0,5 mm	€ 10,60
56...Y	400 x 600 mm	Alluminio spessore 0,7 mm	€ 50,00
FL56...Y	400 x 600 mm	Lamiera sciolata spessore 1 mm	-

AREA SOTTOPOSTA A VIDEOSORVEGLIANZA

Riprese "live" h 24/24 e registrate per 7 giorni

Titolare del trattamento e dati di contatto:
DATI CLIENTE

Dati di contatto del Responsabile della Protezione dei Dati (RPD):
DATI CLIENTE

Scopi della videosorveglianza:
• esigenze organizzative e produttive;
• sicurezza.

Dritti dell'interessato:
L'interessato ha il diritto di chiedere al Titolare di accedere ai dati che lo riguardano, di ottenere la rettifica, la cancellazione, di chiedere la limitazione del loro trattamento, oppure di opporsi al loro trattamento.

Per maggiori dettagli è possibile consultare/vedere l'informazione completa mediante:
QR CODE

DATI CLIENTE

IL SEGNALE RIPORTA TUTTE LE INFORMAZIONI OBBLIGATORIE E FACOLTATIVE DELLE LINEE GUIDA 3/2019.



21388



21398

21398S



33338

27338



22018

27018

22018S

56218Y



33318

27318

56318Y

FL56318Y



33328

27328

56328Y

FL56328Y



33358

27358



33378

27378

56378Y

FL56378Y



33388

27388

56388Y

FL56388Y



33398

27398

56398Y

FL56398Y



33368

27368



A RICHIESTA, CARTELLI PER VIDEOSORVEGLIANZA PERSONALIZZABILI CON I RIFERIMENTI DEL CLIENTE. RICHIEDI PREVENTIVO.



Cartelli per riserve e divieti

In alluminio spessore 0,5, dimensioni 300 x 200 mm.

€ 10,60



TUTTI I CARTELLI PER RISERVE E DIVIETI SONO REALIZZATI CON LA BORDATURA, UNA LAVORAZIONE CHE CONSENTE UNA MAGGIORE RESISTENZA AL VENTO, ALLA TORSIONE E PERMETTE L'APPLICAZIONE DEL CARTELLO SU PALO.

Segnaletica CER

Si utilizzano per segnalare le aree dove vengono stoccati temporaneamente i diversi rifiuti. La versione realizzata su fondo giallo corrisponde ai CER dei rifiuti classificati pericolosi. Cartelli realizzati in alluminio spessore 0,7 mm, dimensioni 500 x 333 mm.

€ 22,60



3307



3308



3309



3310



3312



3313



3314



3319



3320



3321



3323



3325



3401

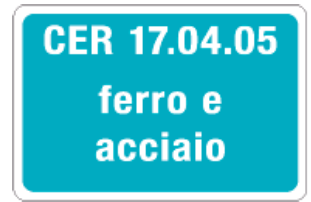

3402

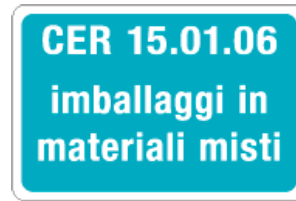

3403

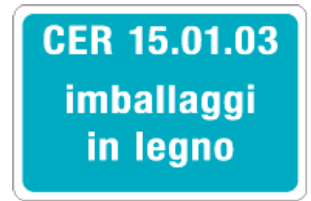

3404

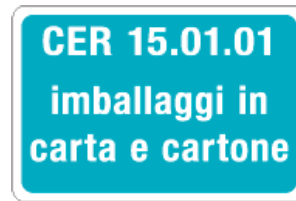

3405

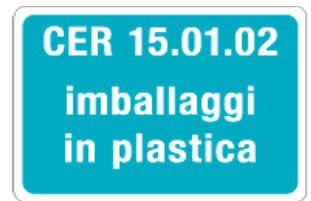

3406



3407



3408



3409



3410



3411



3412

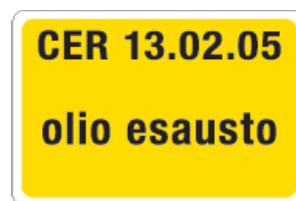

3413

SE TRA LA GAMMA DI SEGNALI CER PRESENTI NELLA PAGINA NON TROVI QUELLO CHE CERCHI, RICHIEDI UN PREVENTIVO PERSONALIZZATO!



CARTELLI PER AREE VERDI

LE PRIME DUE CIFRE DEL CODICE IDENTIFICANO IL FORMATO

CODICE	FORMATO	MATERIALE	PREZZO
21..	350 x 125 mm	Alluminio spessore 0,5 mm	€ 8,30
21.. S	350 x 125 mm	Pellicola autoadesiva	€ 5,40
23..	350 x 125 mm	Alluminio spessore 0,5 mm	€ 8,80
31..	200 x 300 mm	Alluminio spessore 0,5 mm	€ 9,70



ELEVATA RESISTENZA E DURATA DEI MATERIALI (VEDI PAGINA 152).



31200



31201



31202



31203

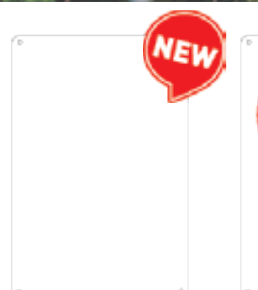

3329



31225



31226



31204



31205



31206



31207



31208



31209



31210



31211



31212



31213



31214



31215



31216



31217



31218



31219



31220



2163



2392



2341



2391



2393



2346



2359

FORNIBILI A RICHIESTA CON ALTRE SCRITTE O SIMBOLI. RICHIEDI UN PREVENTIVO!



Cartelli raccolta rifiuti

LE PRIME DUE CIFRE DEL CODICE IDENTIFICANO IL FORMATO

CODICE	FORMATO	MATERIALE	PREZZO
21..	350 x 125 mm	Alluminio spessore 0,5	€ 8,30
21.. S	350 x 125 mm	Pellicola autoadesiva	€ 5,40
26..	333 x 500 mm	Alluminio spessore 0,7	€ 22,60
29..	333 x 500 mm	Alluminio spessore 0,7	€ 23,60
31../35..	200 x 300 mm	Alluminio spessore 0,5	€ 9,70
35.. S	200 x 300 mm	Pellicola autoadesiva	€ 8,00
43..	665 x 500 mm	Alluminio spessore 1	€ 69,20
48..	200 x 150 mm	Alluminio spessore 0,5	€ 6,10



3501 3501S



3502 3502S



3503 3503S



3504 3504S



3505 3505S



2141 2141 S



2142 2142 S



2143 2143 S



2144 2144 S



2145 2145 S



3506 3506S



3507 3507S



3508 3508S



3509 3509S



3146 2626



2908 3545



3147



4333



4819

FORNIBILI A RICHIESTA CON ALTRE SCRITTE O SIMBOLI. RICHIEDI UN PREVENTIVO!

Segnali da pavimento autoadesivi "a mezzaluna"

Stampa digitale su PVC adesivo spessore 95 micron, rivestimento con film protettivo antiscivolo da 125 micron. Elevata resistenza all'abrasione e al traffico pedonale. Minimo ordinabile: 1 pezzo. Dimensioni 700 x 350 mm.



PP700



PP701



PP702



PP703



PP704

FORNIBILI A RICHIESTA CON ALTRE SCRITTE O SIMBOLI. RICHIEDI UN PREVENTIVO!





CARTELLI DI INDICAZIONE PER MAGAZZINI

DIMENSIONI DEI SEGNALI DI INDICAZIONE

CODICE	FORMATO	MATERIALE
68..	100 x 25 cm	Alluminio spessore 1 mm (4 fori agli angoli)
FL 68..	100 x 25 cm	Lamiera sciolata spessore 1 mm e pellicola PVC adesiva attacchi sul retro (escluso collari)
FLR 68.. *	100 x 25 cm	Lamiera sciolata spessore 1 mm come sopra con rifrangente E.G. marcato
FA 68.. *	100 x 25 cm	Alluminio sciolato spessore 2,5 mm e pellicola PVC adesiva attacchi sul retro (escluso collari)
FAR 68.. *	100 x 25 cm	Alluminio sciolato spessore 2,5 mm come sopra con rifrangente E.G. marcato

* A richiesta.

i PRECISARE LA DIREZIONE DELLA FRECCIA INDICANDO-LA DOPO IL CODICE:
D = DESTRA
A = AVANTI
L = SINISTRA

ESEMPIO



6805 D
(Freccia destra)



6807 L
(Freccia sinistra)



6801

F.. 6801



6802

F.. 6802



6803

F.. 6803



6804

F.. 6804



6805

F.. 6805



6806

F.. 6806



6807

F.. 6807



6808

F.. 6808



6809

F.. 6809



6810

F.. 6810

Freccia direzionale da applicare, fornita a corredo



6811

F.. 6811



6812

F.. 6812



6813

F.. 6813



6814

F.. 6814



6820

F.. 6820



6821

F.. 6821



6822

F.. 6822



6823

F.. 6823



6824

F.. 6824



6825

F.. 6825

⚡ ELEVATA RESISTENZA E DURATA. CARATTERISTICHE DEI MATERIALI A PAGINA 152.



LE PRIME DUE CIFRE DEL CODICE IDENTIFICANO IL FORMATO

CODICE	FORMATO	MATERIALE	PREZZO
33..	300 x 200 mm	Alluminio spessore 0,5 mm	€ 10,60
35..	300 x 200 mm	Alluminio spessore 0,5 mm	€ 10,00
55..	200 x 100 mm	Alluminio spessore 0,5 mm	€ 5,70
85..	250 x 125 mm	Alluminio spessore 0,5 mm	€ 7,30
85.. S	250 x 125 mm	Pellicola autoadesiva	€ 5,60

A RICHIESTA, POSSIAMO REALIZZARE CARTELLI CON ALTRE RAZZE O LA FOTO DEL TUO CANE. (CODICE SXD85). RICHIEDI UN PREVENTIVO!



ELEVATA RESISTENZA E DURATA DEI MATERIALI (PAGINA 152).



8501 Alano



8502 Dobermann



8503 Bull Mastiff



8504 Mastino



8505 Pastore tedesco



8506 Collie



8507 Boxer



8512 Husky



8513 Terranova



8514 Dogue de Bordeaux



8515 Chow Chow



8516 Maremmano



8517 Pastore Belga



8518 Schnauzer



8519 Bulldog



8520 Rottweiler



8521 Labrador



8525 Bull Terrier



8526 Pit Bull



8527 Corso



8528 Setter Gordon



8508 5505



8509



8510 S



8511 S



3322



3552



3556 Doberman e Alano



Cartelli per esercizi commerciali

LE PRIME DUE CIFRE DEL CODICE IDENTIFICANO IL FORMATO

CODICE	FORMATO	MATERIALE	PREZZO
33..	300 x 200 mm	Alluminio spessore 0,5 mm	€ 10,60
33.. P	300 x 200 mm	Polipropilene spessore 0,5 mm	€ 5,10



3324



3340 P



3341 P



3342 P



3343 P



3344 P



3345 P



I CARTELLI 3344 E 3345 SONO FORNIBILI IN POLIIONDA NEL FORMATO 670 X 500 MM (VEDI PAGINA 289).

Cartelli chiusura settimanale

DIMENSIONI CARTELLI CHIUSURA SETTIMANALE

CODICE	FORMATO	MATERIALE	PREZZO
4817..	200 x 150 mm	Alluminio spessore 0,5 mm	€ 6,10
4817 S..	200 x 150 mm	Pellicola autoadesiva	€ 5,90



4817.1



4817.2



4817.3



4817.4



4817.5



4817.6



4817.7

Segnali in pellicola autoadesiva per interni

DIMENSIONI SEGNALI IN PELLICOLA AUTOADESIVA

CODICE	FORMATO	MATERIALE	PREZZO
96.. B	Ø 300 mm	Pellicola autoadesiva	€ 8,90
96.. C	Ø 200 mm	Pellicola autoadesiva	€ 5,50
96.. D	Ø 150 mm	Pellicola autoadesiva	€ 4,80
96.. E	Ø 120 mm	Pellicola autoadesiva	€ 3,70
96.. F	Ø 100 mm	Pellicola autoadesiva	€ 3,70



9635 BCDE



9636 BCDE



9637 BCDE



9633 E rosso
9634 E blu



9638 DE



9639 BCDE



9690 F



9691 F



KIT FOGLIO DI ETICHETTE.

1
CARTELLO IN ALLUMINIO.

CARTELLO CON ORARI E CHIUSURA PERSONALIZZABILI

Cartello in alluminio piano fondo bianco scritta nera, con angoli arrotondati. Comprensivo di catenella, kit di etichette removibili per la personalizzazione dei giorni di chiusura e lancette per la personalizzazione degli orari.

1 OR1218 - cartello, dimensioni 120 x 180 mm, spessore 0,5

2 ORV - ventosa per applicazione su vetro e altre superfici lisce, in confezione da 20 pezzi



Etichette controllo qualità

DIMENSIONI ETICHETTE SERIE 97

CODICE	FORMATO	MATERIALE	PREZZO
97..	175 x 125 mm	Pellicola autoadesiva	€ 2,10



i SERIE 97. MINIMO ORDINABILE 5 ETICHETTE/MULTIPLI.

FORNIBILI A RICHIESTA CON TESTI PERSONALIZZATI. RICHIEDI UN PREVENTIVO!

Segnaletica in lingua straniera

ETICHETTE PER INTERNI IN INGLESE



DIMENSIONI ETICHETTE IN LINGUA STRANIERA

CODICE	FORMATO	MATERIALE	PREZZO
YE96..	165 x 50 mm	Pellicola autoadesiva	€ 5,60
96600	150 x 50 mm	Pellicola autoadesiva	€ 4,90

ESEMPI APPLICAZIONE SEGNALE + FRECCIA



FORNIBILI A RICHIESTA CON TESTI IN ALTRE LINGUE. RICHIEDI UN PREVENTIVO!

CARTELLI SERIE "QUALITÀ" IN INGLESE



DIMENSIONI CARTELLI SERIE "QUALITÀ"

CODICE	FORMATO	MATERIALE	PREZZO
YE26..	500 x 333 mm	Alluminio spessore 0,7 mm	€ 38,40

⚡ ELEVATA RESISTENZA E DURATA DEI MATERIALI. VEDI PAGINA 152.



SISTEMI PER LA COMUNICAZIONE VISIVA

SEGNALETICA "METAL SIGN"	173
SISTEMI DI SEGNALETICA AUTOGESTIBILI PER INTERNI.....	173
SISTEMI PER LA COMUNICAZIONE VISIVA.....	174-177,
CORNICI E CASSETTE PORTACHIAVI.....	178
BACHECHE E LAVAGNE	179, 185
TARGHE PORTAPLANIMETRIE.....	180
SISTEMI PER LA COMUNICAZIONE VISIVA.....	181-183
LEGGII, CARTELLINE, SUPPORTI E BUSTE	182-183
WALL ORGANIZER, PORTANOMI E PORTABADGE	184
SISTEMI ESPOSITIVI PER INTERNI ED ESTERNI	185-187
COLONNINE TENDINASTRO SAFE IN®	188-191
COLONNINE CON CORDONE	192
PANNELLI DIVISORI E KIT BANNER	193
SEGNALETICA D'AMBIENTE DESIGN & SYSTEM	194-195
INSEGNE.....	196

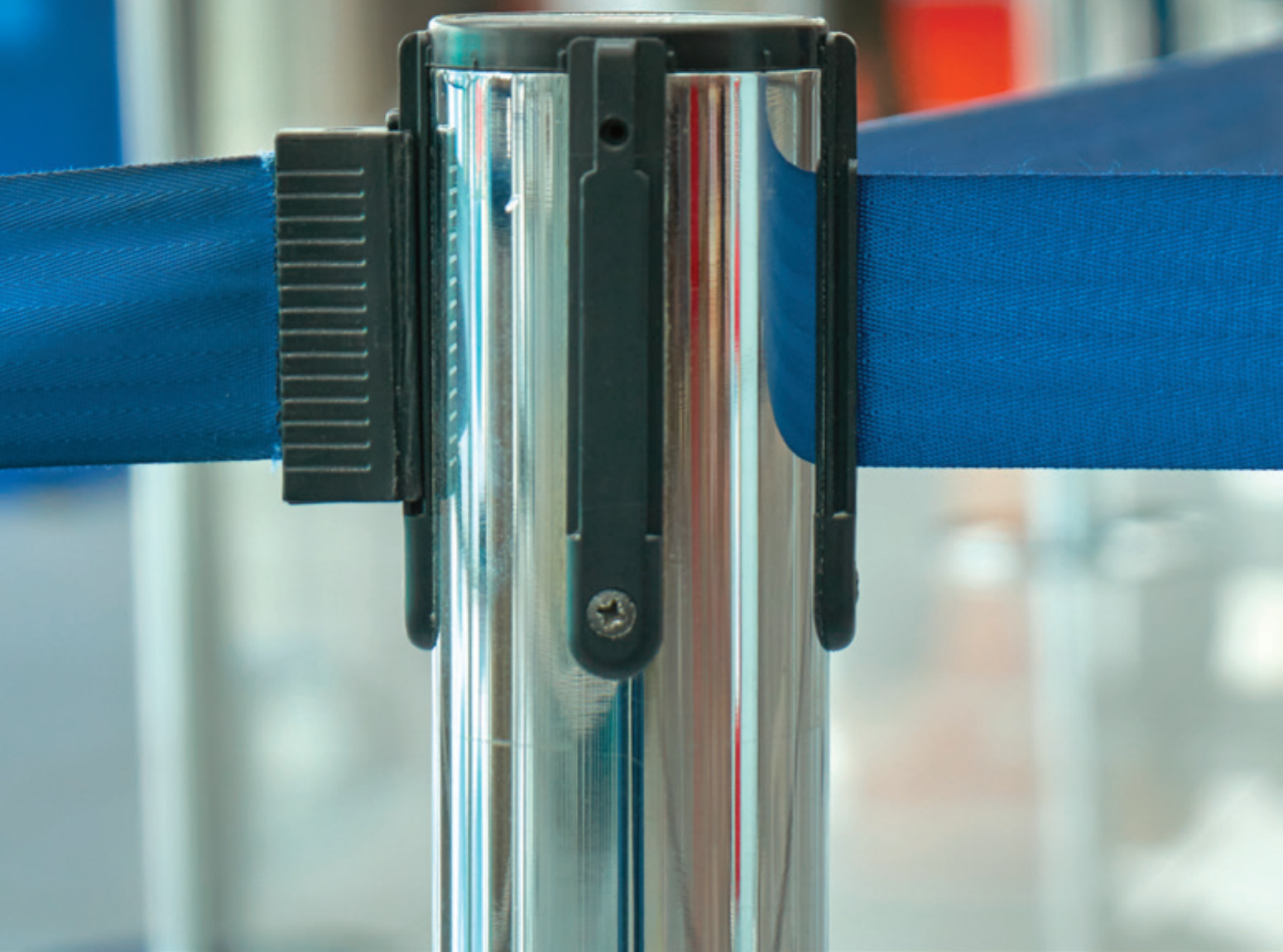



Sistema di segnaletica Metalsign

Sistema modulare costituito da una gamma di profili in alluminio piatto (spessore mm 4) dalla linea essenziale e discreta. La gestione della grafica su supporto cartaceo, protetta da un foglio in PET trasparente antiriflesso spessore mm 1,2, permette di realizzare autonomamente messaggi di grande impatto visivo e un costante aggiornamento delle informazioni. Disponibile nelle versioni monofacciale e bifacciale a bandiera. Utilizzo verticale ed orizzontale. Materiale per il montaggio compreso nella fornitura (viti e tasselli). Il sistema Metalsign è disponibile nella versione standard con profilo in alluminio (vedi pagine 104 - 109) e con profili colorati, raggiungendo dopo il codice la lettera identificatrice del colore:

W bianco (RAL 9016) **R** rosso (RAL 3020) **BS** blu segnale (RAL 5005)
G verde (RAL 6024) **A** antracite (RAL 7016)



VERSIONE MONOFACCIALE

- 1 **SEMS1015.** - targa monofacciale mm 148 x 105
- 2 **SEMS1515.** - targa monofacciale mm 148 x 148
- 3 **SEMS2121.** - targa monofacciale mm 210 x 210
- 4 **SEMS1529.** - targa monofacciale mm 297 x 148
- 5 **SEMS2129.** - targa monofacciale mm 297 x 210
- 6 **SEMS2942.** - targa monofacciale mm 420 x 297



STAMPA AUTONOMA
SU CARTA, FACILMENTE
INTERCAMBIABILE!



VERSIONE BIFACCIALE A BANDIERA

- 7 **SEMS1515B.** - targa bifacciale mm 148 x 148
- 8 **SEMS2121B.** - targa bifacciale mm 210 x 210
- 9 **SEMS2115B.** - targa bifacciale mm 148 x 210 (b x h)
- 10 **SEMS2921B.** - targa bifacciale mm 210 x 297 (b x h)
- 11 **SEMKEY** - chiave a brugola (necessaria per il montaggio delle targhe bifacciali) da ordinare separatamente

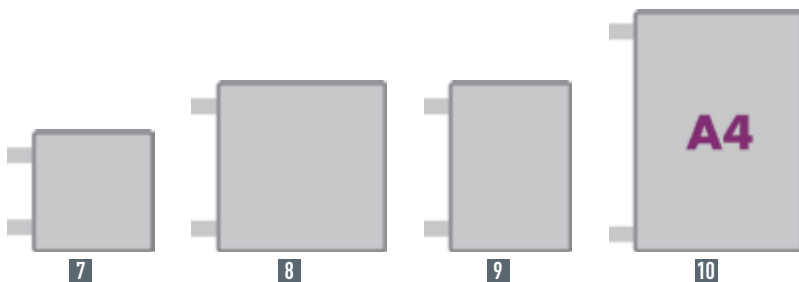

12 SIGNCODE IN-OUT

Pratico sistema per sapere se una sala è occupata o no, semplicemente spostando con la mano la targhetta in rilievo. In alluminio anodizzato color argento stampato verde "libero" e rosso "occupato". Si applica con tasselli e viti (compresi nella fornitura) oppure con biadesivo (non fornito).

TKS148 - signcode libero/occupato, dimensioni mm 148 x 148





SISTEMI PER LA COMUNICAZIONE VISIVA



1



A



2

1 TARGHE MURALI O DA BANCO CONVESSE



Targhe in policarbonato di alta qualità dal profilo curvo. A prova di polvere, senza cornici laterali. Apertura da entrambi i lati mediante una semplice pressione sugli angoli (A). Ideali per informazioni che si cambiano frequentemente, resistenti e di aspetto gradevole. Fornite con biadesivo o con viti per l'applicazione a muro o banda per l'utilizzo da banco (tranne per il formato A6 la cui banda viene fornita separatamente).

TKPQ21 - targa formato A4 (mm 210 x 297)

TKPQ14 - targa formato A5 (mm 210 x 148)

TKPQ10 - targa formato A6 (mm 148 x 105)

TKPQ6 - supporto da tavolo per formato A6

2 TARGA A PARETE



In policarbonato stampato in pressofusione: copertura trasparente. Facile da montare, si fissa con viti o tramite nastro biadesivo incluso (per l'applicazione su superfici lisce - es. vetro).

TKPD297 - targa formato A4 (mm 210 x 297)

TKPD420 - targa formato A3 (mm 297 x 420)

TKPD105 - targa mm 150 x 105

TKPD150 - targa mm 150 x 150



3



3 SISTEMA DI TARGHE MURALI IN POLICARBONATO



Sistema di targhe murali a tasche in policarbonato per esporre comunicazioni facili da inserire, rimuovere e sostituire. Utile per esporre avvisi, planimetrie di sicurezza, piani di evacuazione, piani di controllo, tariffari, schede di manutenzione e schede tecniche. Fissaggio alla parete semplice e veloce mediante biadesivo (compreso).

KGV21 - targa murale per foglio A4, apertura verticale (mm 210 x 297)

KG021 - targa murale per foglio A4, apertura orizzontale (mm 297 x 210)

KGV14 - targa murale per foglio A5, apertura verticale (mm 150 x 210)

KG014 - targa murale per foglio A5, apertura orizzontale (mm 210 x 150)

KGV29 - targa per foglio A3, apertura orizzontale (mm 420 x 297). A richiesta, versione con attacco a muro

5



A

5 TARGHE MURALI CON PROFILO PIATTO



Targhe in materiale plastico stampato ad iniezione per interni dalla superficie piana. Senza cornici laterali, leggere, queste targhe sono una soluzione economica per l'esposizione di fogli singoli. Sostituzione veloce e pratica dei fogli. Protezione frontale trasparente flessibile (A). Fornite con biadesivo.

TKLI52 - targa formato A8 (mm 52 x 74)

TKLI74 - targa formato A7 (mm 74 x 105)

TKLI105 - targa formato A6 (mm 105 x 148)

TKLI148 - targa formato A5 (mm 148 x 210)

TKLI210 - targa formato A4 (mm 210 x 297)

TKLI297 - targa formato A3 (mm 297 x 420)



4

4 INFOBOX

Sistema di comunicazione intercambiabile autogestibile per comunicare: programmi, eventi, listini, avvisi, tabelle ecc... Può contenere fino a 10 fogli. Il colore della cornice può essere utilizzato per caratterizzare le diverse tipologie di comunicazione. Si applica alla parete tramite viti non comprese nella fornitura. Protezione frontale trasparente.

INFOA4 - cornice Infobox formato A4. Colori: **S** grigio **B** blu



1 TARGA A PARETE IN ACRILICO

Targa composta da 2 pannelli in acrilico e distanziali a vite in argento anodizzato. La parte grafica è intercambiabile, realizzabile su carta da parte dell'utente stesso mediante l'uso di un PC, in totale autonomia. Di facile installazione tramite distanziali (inclusi nella confezione). Altri formati fornibili a richiesta.

TDC337 - targa composta da 2 pannelli in acrilico mm 337 x 215 e 4 distanziali (per formato carta A4)

TDC460 - targa composta da 2 pannelli in acrilico mm 460 x 300 e 4 distanziali (per formato carta A3)

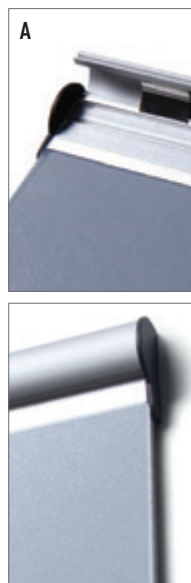

2 TARGA A PARETE IN ALLUMINIO

Targa a parete composta da 2 profili in alluminio 1,5 cm cadauno con apertura a scatto (A). Fondo in materiale plastico grigio e protezione in PVC antiriflesso 1 mm. La parte grafica è intercambiabile, realizzabile su carta da parte dell'utente stesso mediante l'uso di un PC, in totale autonomia. Di facile installazione mediante viti o biadesivo (non inclusi nella confezione). Altri formati fornibili a richiesta.

TDC105 - targa monofacciale A6, 105 x 148 mm

TDC106 - targa monofacciale A5, 148 x 210 mm

TDC107 - targa monofacciale A4, 210 x 297 mm



TARGA MONOFACCIALE E BIFACCIALE CONVESSA IN ALLUMINIO

Targa composta da supporto in alluminio estruso anodizzato naturale comprensivo di tappi terminali in materiale metallico e protezioni in PVC antiriflesso. La versione monofacciale è utilizzabile sia in verticale che orizzontale. La parte grafica è intercambiabile, realizzabile su carta da parte dell'utente stesso mediante l'uso di un PC, in totale autonomia. Di facile installazione tramite viti (inclusi nella confezione). Altri formati fornibili a richiesta.

3 TDC150 - targa monofacciale A5, 148 x 210 mm

TDC151 - targa monofacciale 148 x 148 mm

TDC152 - targa monofacciale 210 x 120 mm

TDC153 - targa monofacciale A3, 297 x 420 mm

4 TDC154 - targa bifacciale 148 x 148 mm

TDC155 - targa bifacciale 210 x 148 mm



5 BARRA APPENDIFOGLI DA PARETE

Profilo arrotondato in alluminio anodizzato estruso con all'interno cilindretti zigrinati in PVC che permettono un facile inserimento di fogli multipli, anche in formati differenti. Fornibile in 4 lunghezze diverse per adattarsi a qualsiasi ambiente di lavoro. Biadesivo per l'applicazione a parete incluso nella fornitura.

SMCT9033 - barra appendifogli lunghezza cm 70, peso g 300

SMCT9034 - barra appendifogli lunghezza cm 100, peso g 400

SMCT9035 - barra appendifogli lunghezza cm 140, peso g 600

SMCT9036 - barra appendifogli lunghezza cm 200, peso g 800





1



VERSIONE
DA BANCO

2



VERSIONE
DA PARETE



TASCHE PORTADEPLIANT DA BANCO E A PARETE

Tasche in metacrilato trasparente resistenti e pratiche per l'esposizione di materiale informativo. Disponibili nei modelli singoli o multipli. Altri formati e altre combinazioni fornibili a richiesta.

- 1 **TKPDM21** - porta depliant da banco multiplo, 4 tasche per formato A4
- TKPDS21** - porta depliant da banco singolo per formato A4
- 2 **TKPPM21** - porta depliant da parete multiplo, 3 tasche per formato A4
- TKPPS21** - porta depliant da parete singolo per formato A4



3 TASCHE PORTA DOCUMENTI A MURO

Kit composto da: barra in alluminio da mm 750 e 3 tasche colorate, che si agganciano alla barra ad incastro (viti di fissaggio barra inclusi nella fornitura). Ideale per archiviazione di documenti in base al colore della tasca per una immediata identificazione. Dimensioni tasche: mm 235 x 250 h.

SMET2127 - kit porta documenti a muro completo di barra e 3 tasche colorate (1 rossa, 1 gialla, 1 verde)

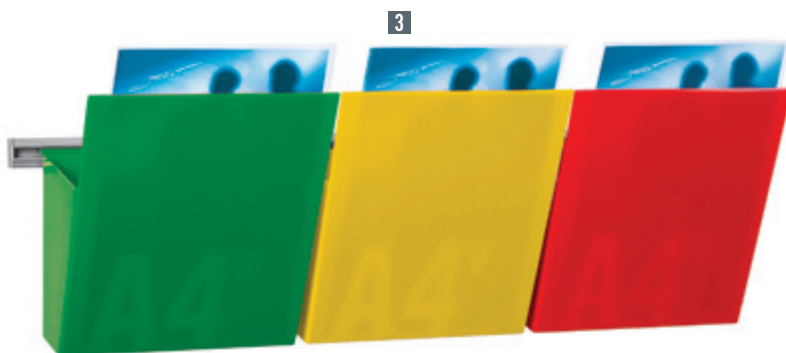

3



4 TASCHE PORTA DOCUMENTI DA SCRIVANIA

Kit composto da: barra da scrivania in alluminio anodizzato silver completamente riciclabile con morsetto di fissaggio (non servono fori nè viti) e 3 tasche colorate. Dimensioni barra cm 80 x 27.

SMET2128 - kit porta documenti da scrivania completo di barra e 3 tasche colorate (1 rossa, 1 gialla, 1 verde)

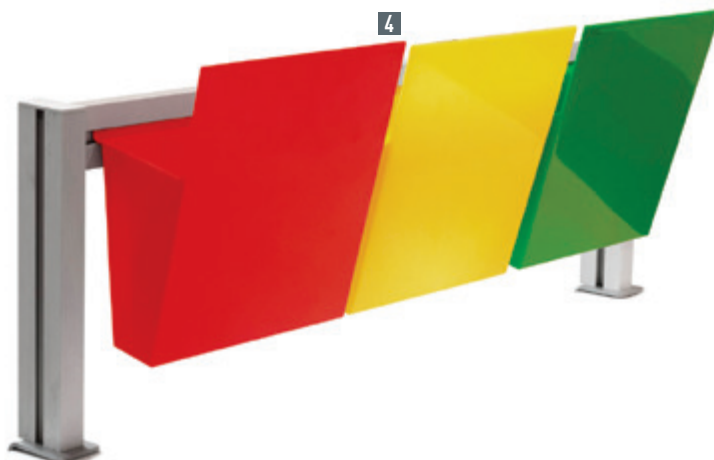

4



1 TARGA SEGNANOME DA TAVOLO

Profilo triangolare flessibile robusto e di ottima qualità. Sostituzione semplice dell'informazione contenuta. Tappi di chiusura color grigio, protezione trasparente in plastica, dotato di sistema antimanomissione (con chiave). Spessore massimo del supporto cartaceo mm 1,5. Perfetto come targa porta nomi o porta informazioni o come porta prezzi da banco.

TKPD05 - targa segnanome da tavolo, dimensioni 153 x 50 x 36 h

TKPD06 - targa segnanome da tavolo, dimensioni 215 x 50 x 36 h

TKPD07 - targa segnanome da tavolo, dimensioni 302 x 50 x 36 h



2 PORTA FOGLI DA TAVOLO BIFACCIALE A "T"

Porta avvisi/fogli singoli da tavolo bifacciale con base a "T" in polistirene trasparente.

SMET297 - porta fogli da tavolo bifacciale formato A4 verticale. Dimensioni mm 210 x 297



PORTA FOGLI DA TAVOLO A "L"

Porta avvisi/fogli singoli da tavolo a "L" in polistirene trasparente stampato ad iniezione.

3 SMET210 - porta foglio formato A4 verticale. Dimensioni mm 210 x 297

4 SMET148 - porta foglio formato A5 verticale. Dimensioni mm 148 x 210

5 SMET105 - porta foglio formato A6 verticale. Dimensioni mm 105 x 148



PORTA DEPLIANT FORMATO 1/3 DI A4

Per depliant mm 110 x 220 (1/3 di A4).

6 SMET101 - porta depliant a 1 tasca (dimensione tasca 108 x 209 x 65 mm)

7 SMET102 - porta depliant a 2 tasche (dimensione tasca 108 x 209 x 65 mm)

8 SMET104 - porta depliant a 4 tasche (dimensione tasca 108 x 255 x 158 mm)



PORTA DEPLIANT FORMATO A5

Per depliant mm 148 x 210 (formato A5).

9 SMET201 - porta depliant a 1 tasca (dimensione tasca 157 x 214 x 74 mm)

10 SMET202 - porta depliant a 2 tasche (dimensione tasca 157 x 208 x 74 mm)

11 SMET204 - porta depliant a 4 tasche (dimensione tasca 157 x 255 x 158 mm)



PORTA DEPLIANT FORMATO A4

Per depliant mm 210 x 297 (formato A4).

12 SMET301 - porta depliant a 1 tasca (dimensione tasca 224 x 266 x 94 mm)

13 SMET302 - porta depliant a 2 tasche (dimensione tasca 224 x 266 x 94 mm)

14 SMET304 - porta depliant a 4 tasche (dimensione tasca 224 x 299 x 190 mm)



Cornici a scatto linea Easy per interni



1 CORNICI A SCATTO PROFILO 25 MM

Profilo mm 25 in anodizzato naturale. Angoli arrotondati. Retro in plastica, protezione antiriflesso trasparente, disponibile in diversi formati.

- SMCT210** - mm 240 x 327, per foglio formato A4
- SMCT297** - mm 327 x 450, per foglio formato A3
- SMCT500** - mm 530 x 730, per foglio mm 500 x 700
- SMCT420** - mm 420 x 594, per foglio formato A2
- SMCT594** - mm 594 x 841, per foglio formato A1
- SMCT710** - mm 700 x 1000
- SMCT841** - mm 841 x 1189, per foglio formato A0

2 CORNICI A SCATTO PROFILO 32 MM

Profilo mm 32 in anodizzato naturale. Angoli arrotondati. Retro in plastica, protezione antiriflesso trasparente, disponibile in diversi formati.

- SMCT700** - mm 745 x 1045, per foglio mm 700 x 1000,
- SMCT701** - mm 1045 x 1445, per foglio mm 1000 x 1400

3 CORNICI A SCATTO COLORATE PER INTERNI

Profilo mm 25 in alluminio verniciato. Angolo vivo. Altri formati fornibili a richiesta.

- Colori: **W** bianco (RAL 9003) **R** rosso (RAL 3020)
- SMCT418** - per foglio formato A4 (210 x 297 mm), dimensioni esterne mm 240 x 327
 - SMCT419** - per foglio formato A3 (297 x 420 mm), dimensioni esterne mm 327 x 450



4 CASSETTE PORTACHIAVI

Cassette in metallo verniciato di diverse capacità, complete con il medesimo numero di portachiavi in plastica. Colore grigio. Altre capacità fornibili a richiesta (richiedi un preventivo).

- ASTC24** - cassetta per 24 chiavi, mm 180 x 250 x 60
- ASTC48** - cassetta per 48 chiavi, mm 180 x 250 x 80
- ASTC90** - cassetta per 90 chiavi, mm 240 x 300 x 80
- ASTC140** - cassetta per 140 chiavi, mm 280 x 370 x 80

BACHECA PORTACHIAVI

Bacheca per interni con pannello in acciaio laccato, superficie magnetica con ganci numerati, struttura in alluminio anodizzato. Anta trasparente in metacrilato, apertura a libro. Chiusura con serratura. Profondità interna 30 mm. Materiale per il fissaggio a muro incluso.

- 5 SWB045A** - bacheca per 45 chiavi, dimensioni mm 434 x 548, peso 3 kg
- 6 SML090A** - bacheca per 90 chiavi, dimensioni mm 750 x 590, peso 5 kg

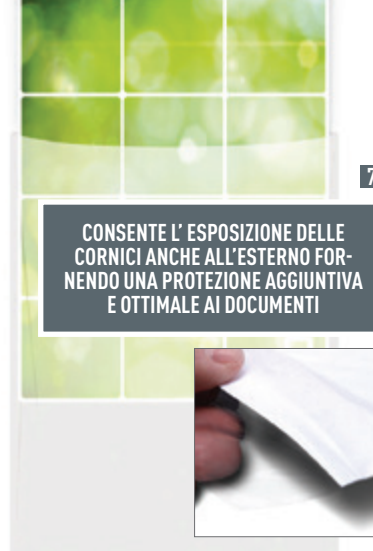

7 PROTEGGI DOCUMENTI POSTER BAG

Buste per aggiungere protezione a poster e documenti che si vuole inserire in cornici e altri sistemi per la comunicazione visiva. Resistente agli UV e all'umidità. Pratico, offre un sistema veloce per la sostituzione dei messaggi.

- SMBT4** - busta per foglio A4 (mm 210 x 297)
- SMBT2** - busta per foglio mm 500 x 700
- SMBT5** - busta per foglio mm 500 x 700
- SMBT3** - busta per foglio A3 (mm 297 x 420)



BACHECA LINEA EASY PER INTERNI

Bacheca **ultrapiatta** per uso interno. Profilo in alluminio con angoli in plastica colore grigio, protezione frontale in acrilico. Chiusura a una o due serrature con chiave.

1 **Versione con retro in lamiera bianca magnetica e scrivibile.**

- SMBT32** - mm 491 x 350 h, per 2 fogli A4
- SMBT34** - mm 491 x 655 h, per 4 fogli A4
- SMBT36** - mm 711 x 655 h, per 6 fogli A4
- SMBT38** - mm 931 x 655 h, per 8 fogli A4
- SMBT312** - mm 931 x 963 h, per 12 fogli A4, con 2 serrature

2 **Versione con retro in sughero naturale per utilizzo di puntine.**

- SMBT44** - mm 491 x 655 h, per 4 fogli A4
- SMBT46** - mm 711 x 655 h, per 6 fogli A4
- SMBT48** - mm 931 x 655 h, per 8 fogli A4
- SMBT412** - mm 931 x 963 h, per 12 fogli A4, con 2 serrature



3 **LAVAGNA IN SUGHERO**

Lavagna con retro in sughero naturale a nido d'ape per l'utilizzo con puntine. Si utilizza in ambienti interni orizzontalmente o verticalmente. Bordo in alluminio mm 35, angoli di sicurezza.

- SMLT96** - dimensioni esterne mm 900 x 600 (utili mm 866 x 566)
- SMLT97** - dimensioni esterne mm 1200 x 900 (utili mm 1166 x 866)
- SMLT98** - dimensioni esterne mm 1500 x 1000 (utili mm 1466 x 966)



4 **BACHECA PER INTERNI ED ESTERNI**

Bacheca apertura a libro, con cornice perimetrale in alluminio anodizzato con protezione in policarbonato. Retro in lamiera scrivibile e magnetica. Si raccomanda l'utilizzo esterno in zona protetta da tettoia. Chiusura a una o due serrature con chiave.

- SMBT52** - per 2 fogli A4, dimensioni esterne mm 521 x 388 h
- SMBT54** - per 4 fogli A4, dimensioni esterne mm 521 x 696 h
- SMBT56** - per 6 fogli A4, dimensioni esterne mm 741 x 696 h
- SMBT58** - per 8 fogli A4, dimensioni esterne mm 961 x 696 h
- SMBT512** - per 12 fogli A4, dimensioni esterne mm 961 x 1004 h, con 2 serrature



5 **BACHECA PER ESTERNI CERTIFICATA IP56**

Bacheca con profili in alluminio anodizzato e vetro temperato di chiusura per uso interno ed esterno. Retro in lamiera scrivibile e magnetica con apertura a compasso (dal formato per 12 fogli in su, con pompa idraulica che rende agevole e morbida l'apertura). Chiusura a una o due serrature con chiave. Grado di protezione IP56.

5 **SMBT66** - bacheca per 6 fogli A4, dimensioni esterne mm 805 x 760 h

- SMBT69** - bacheca per per 9 fogli A4, dimensioni esterne mm 805 x 1067 altezza
- SMBT612** - bacheca per 12 fogli A4, dimensioni esterne mm 1025 x 1067 altezza
- SMBT615** - bacheca per 15 fogli A4, dimensioni esterne mm 1245 x 1067 altezza, con 2 serrature
- SMBT618** - bacheca per 18 fogli formato A4, dimensioni esterne mm 1465 x 1067 altezza, con 2 serrature



6 **SMBQ200** - coppia di pali per esterni con base mm 150 x 150, altezza 2000 mm. Realizzati in acciaio verniciato color argento RAL9006. Forniti con piastre per attacco alla bacheca IP56. Fornibili a richiesta versione da interrare (codice SMBQ250)

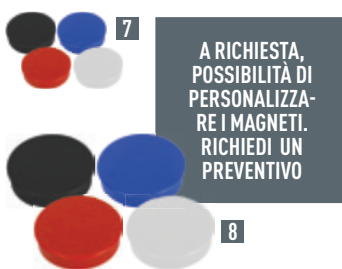

A RICHIESTA, POSSIBILITÀ DI PERSONALIZZARE I MAGNETI. RICHIEDI UN PREVENTIVO



ACCESSORI PER LAVAGNE E BACHECHE

- 7** **SMAT20** - confezione da 8 magneti Ø mm 20. Colori: **W** bianco **N** nero **R** rosso **B** blu
- 8** **SMAT35** - confezione da 8 magneti Ø mm 35. Colori: **W** bianco **N** nero **R** rosso **B** blu
- 9** **SMAT36** - confezione da 4 pennarelli cancellabili (colori verde, rosso, nero e blu)
- 10** **SMAT37** - cancellino
- 11** **SMAT100** - scatola da 100 puntine



Targhe porta planimetrie

- ♦ A richiesta è fornibile la vostra planimetria rielaborata secondo la Norma UNI ISO 23601:2009 (richiedere preventivo).
- ♦ Grafica realizzabile a nostra cura in stampa digitale, dietro fornitura di file esecutivo di stampa.



1 TARGA PORTA PLANIMETRIA IN POLICARBONATO

In policarbonato trasparente copertura trasparente rigida. Senza cornici laterali, dal profilo piatto, leggera. Si fissa alla parete con viti o tramite nastro biadesivo (incluso nella fornitura). Per l'utilizzo verticale e orizzontale.

TKPD420 - targa formato A3 (dimensioni mm 420 x 297) - grafica esclusa



2 TARGA PORTA PLANIMETRIA IN ACRILICO

Composta da due pannelli in acrilico e distanziali a vite in argento anodizzato. Di facile installazione tramite distanziali (inclusi nella fornitura). Per l'utilizzo verticale e orizzontale.

TDC460 - targa per fogli A3 (dimensioni mm 460 x 300) - grafica esclusa



3 TARGA PORTA PLANIMETRIA IN ALLUMINIO

In alluminio con tappi colorati in PVC verde (RAL 6024), protezione frontale trasparente in PVC. Sistema di fissaggio incluso nella fornitura (viti e tasselli).

SEMPIC - targa formato A3 (dimensioni mm 420 x 297) - grafica esclusa

SEMPICST - targa formato A3 (dimensioni mm 420 x 297) comprensiva di grafica (occorre fornire file esecutivo di stampa)

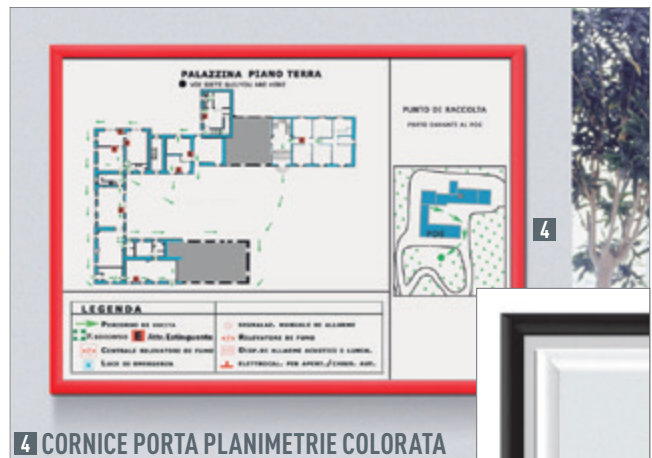

4 CORNICE PORTA PLANIMETRIE COLORATA

Cornice a scatto profilo mm 25 in alluminio verniciato, retro in plastica, protezione trasparente in PVC. Angolo vivo. Per l'utilizzo verticale e orizzontale. Sistema di fissaggio non incluso nella fornitura.

Colori: **W** bianco (RAL9003) **N** nero (RAL9005) **R** rosso (RAL3020)

SMCT419 - cornice formato A3 (dimensioni mm 420 x 297) - grafica esclusa



ALTRE TARGHE PORTA PLANIMETRIE PRESENTI ALLE PAGINE 95, 100, 109 E 110.

5 TARGA PORTA PLANIMETRIA IN MATERIALE PLASTICO

In materiale plastico stampato ad iniezione, protezione frontale trasparente e flessibile per una pratica sostituzione delle planimetrie. Senza cornici laterali, dal profilo piatto, leggera. Si fissa alla parete con biadesivo (incluso nella fornitura). Per l'utilizzo verticale e orizzontale.

TKLI297 - targa formato A3 (dimensioni mm 297 x 420) - grafica esclusa



6 TARGA PORTA PLANIMETRIA IN VETRO

In vetro temperato. La planimetria viene stampata su supporto adesivo e applicata sul retro della targa. Si fissa al muro con un sistema invisibile e semplice che si applica alla parete con viti comprese nella fornitura. Per l'utilizzo verticale e orizzontale.

SECFP - targa formato A3 (dimensioni mm 297 x 420) - grafica esclusa

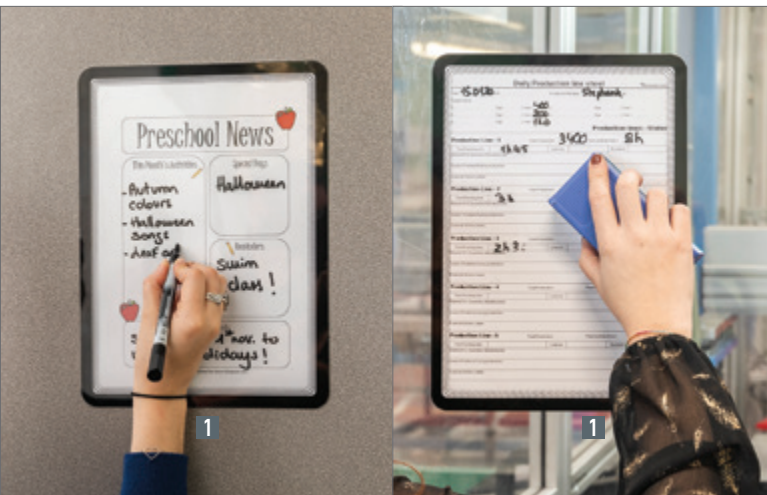

1 CORNICE CON PROTEZIONE FRONTALE SCRIVIBILE E CANCELLABILE

Cornice in PET di colore nero per documenti che contengono campi che subiscono frequenti aggiornamenti. I documenti possono essere visualizzati in modo permanente e le annotazioni possono essere aggiunte e cancellate facilmente sulla protezione frontale in PET, senza danneggiare il documento. Formato A4 (utilizzabile in posizione verticale o orizzontale). Cancellabile anche dopo diversi mesi. Retro adesivo removibile e riposizionabile. Chiusura magnetica su 3 lati. Può essere applicato su vetro o su altre superfici piane e lisce.

SMCA498N - confezione da 2 pezzi cornice nera con protezione scrivibile, mm 230 x 317 (formato A4).



2 CORNICE MAGNETICA PER FOGLI SENZA PROTEZIONE FRONTALE

Cornici colorate in PVC magnetiche per fogli. Strumento indispensabile per i sistemi di gestione LEAN. Migliora e consente di classificare in base al colore della cornice qualsiasi comunicazione scritta a mano. Per messaggi o informazioni scritte a mano, orari, documenti da firmare, note, fogli di lavoro, programmi di pulizia, ecc. Formato A4 (utilizzabile in posizione verticale o orizzontale). Strisce magnetiche sul retro, lungo tutti e 4 i bordi. Nessuna pellicola frontale.

SMCA499 - confezione da 10 cornici colorate magnetiche per fogli A4.

Colori: **N** nero **S** grigio **B** blu **R** rosso **G** verde



VERSIONE SAFETY LINE

APERTURA SU 3 LATI



CORNICE MAGNETO CON RETRO ADESIVO O MAGNETICO

Cornice A4 originale ed elegante, angoli arrotondati. Dotata di comoda chiusura magnetica sul lato superiore che permette di sostituire agevolmente il contenuto. Posizionamento orizzontale o verticale. In PVC antiriflesso di elevato spessore (fronte 300 micron, retro 100 micron). Dimensioni 242 x 329 mm. Disponibile nella versione Safety Line ideale per ambienti industriali.

3 SMCA492 - confezione da 2 cornici Safety Line con retro magnetico.

Colori: **WR** bianco-rosso **VG** bianco-verde **NY** nero-giallo

SMCA497 - confezione da 2 cornici Safety Line con retro adesivo.

Colori: **WR** bianco-rosso **VG** bianco-verde **NY** nero-giallo

4 SMCA490 - confezione da 2 cornici Magneto con retro magnetico.

Colori: **N** nero **S** grigio **R** rosso **B** blu **A** arancio fluo

SMCA495 - confezione da 2 cornici Magneto con retro adesivo.

Colori: **N** nero **S** grigio **R** rosso **B** blu **A** arancio fluo



TARGHE E PORTA ETICHETTE CON RETRO ADESIVO O MAGNETICO

Perimetro rigido in ABS, ideali per utilizzo industriale. La targhetta 80 x 45 mm è perfetta per utilizzo in magazzino. Colori: **R** rosso **B** blu

5 SMCA488 - cornice adesiva formato A4

SMCA489 - cornice magnetica formato A4

6 SMCA486 - confezione da 4 targhette magnetiche formato 80 x 45 mm



1



1 SUPPORTO MAGNETICO CON BASE PORTAPENNE

Supporto in alluminio sottile e leggero. Consente la visualizzazione e l'archiviazione di più documenti in un unico posto. Può contenere fogli perforati e tasche di plastica perforate. Per uso orizzontale e documenti formato A4.

SMCA791 - supporto con 4 anelli a D, dimensioni mm 310 x 320 x 53



2

2 CARTELLINE CON RETRO ADESIVO O MAGNETICO

Cartelline a L formato A4, in PVC antiriflesso. Facile inserimento del foglio. Capacità 10 fogli A4. Ideali per la documentazione che deve essere frequentemente aggiornata.

SMCA779 - confezione da 5 buste **adesive** (adesivo removibile e riposizionabile) con chiusura calamitata sull'angolo. Angoli colori assortiti

SMCA729 - confezione da 5 buste **magnetiche** con chiusura tramite flap sul lato superiore magnetico. Angoli colori assortiti



INDICATE
PER SUPERFICI
IN VETRO

FACILE
INSERIMENTO
DEL FOGLIO



3

4

BANDA
POSTERIORE
MAGNETICA

BUSTE ADESIVE O MAGNETICHE

Buste formato A4 con apertura sul lato corto. Cornice rinforzata con anima in metallo. La versione adesiva è munita di retro adesivo removibile e riposizionabile. La versione magnetica presenta una banda posteriore magnetica.

3 SMCA529 - confezione da 5 buste **adesive** formato A4, colori assortiti

4 SMCA607 - confezione da 5 buste **magnetiche** formato A4, colore nero



5

APERTURA
SUL LATO
CORTO

5 CARTELLINE SOSPESSE CON GANCIO

Comode cartelline in PVC antiriflesso, con gancio in acciaio ultra resistente.

SMCA450 - confezione da 5 cartelline A4 verticale. Colori: **R** rosso **B** blu **A** assortiti

SMCA451 - confezione da 5 cartelline A4 orizzontale. Disponibile in colori assortiti

SMCA452 - confezione da 5 cartelline A3 orizzontale. Disponibile in colori assortiti

6 TASCA PORTA DEPLIANT CON GANCIO

Formato A4 con ganci, con tasca anteriore di 2 cm (pari a circa 180 fogli). Tasca posteriore per l'inserimento della copia originale in modo che non sia prelevabile e rimanga leggibile una volta esaurite le altre copie.

SMCA453 - confezione da 5 tasche porta depliant colore blu, orientamento verticale

SMCA454 - confezione da 5 tasche porta depliant colore blu, orientamento orizzontale



6



1



2

A RICHIESTA FORNIBILI LEGGII STERILI (COLORI BIANCO E NERO) PER AMBIENTI PROTETTI.

LEGGIO A MURO

Può essere fissato a qualsiasi superficie verticale (elementi di fissaggio inclusi). Base in metallo con 10 buste in PVC con apertura superiore e bordo rinforzato con anima in acciaio e 5 cavalierini da 50 mm. Gli angoli in plastica permettono di inclinare il leggio per facilitare la lettura. Ampliabile all'infinito tramite l'aggiunta della base di ampliamento e altre buste.

Colori: **N** nero **R** rosso **B** blu **G** verde **Y** giallo **A** assortiti (2 buste per colore)

- 1 **SMCA410** - leggio da muro a 10 buste formato A4 (scegliere colore)
- 2 **SMCA411** - base per 10 buste per ampliamento leggio a muro



3

3 LEGGIO DA TAVOLO

Leggio da tavolo formato A4 con base in metallo. Versione con 10 o 30 buste in PVC con apertura superiore e bordo rinforzato con anima in acciaio, 5 o 15 cavalierini (A) da 50 mm. Colori buste assortiti (blu, rosso, giallo, verde, nero).

- SMCA109** - leggio da tavolo a 10 buste formato A4
- SMCA309** - leggio da tavolo a 30 buste formato A4



4

A4

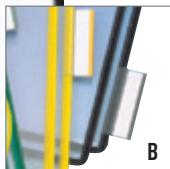

B



5



6

BUSTE

- 4 **SMCA400** - confezione da 10 buste A4 per leggio da tavolo o a muro, con apertura lato corto. Fornite con 5 cavalierini (B) da 50 mm.
Colori: **N** nero **R** rosso **B** blu **G** verde **Y** giallo **A** assortiti (2 buste per colore)
- 5 **SMCA401** - confezione da 5 cartelline Fold Up A4 con alta capacità, per leggio da tavolo o a muro. Struttura rigida in PVC, ogni busta può contenere fino a 40 fogli di carta, brochures ecc. Bordo blu
- 6 **SMCA402** - confezione da 5 cartelline di grande capacità per leggio da tavolo o a muro. Contengono 5 volte di più rispetto alla cartellina standard poiché ogni cartellina è collegata a 4 cartelline supplementari. Le vostre informazioni saranno immediatamente disponibili in uno spazio minimo. Colori assortiti



7

7 CARTELLINE MAGNETICHE

Cartelline preforate in PVC a lunga durata. Antiriflesso, a doppio lato. I magneti garantiscono una presa ottimale sulla superficie o tra di loro. Da utilizzare con gli articoli SMCA790 e SMCA791.

Colori: **R** rosso **B** blu **G** verde **Y** giallo

- SMCA79** - confezione 5 cartelline preforate magnetiche (abbinare lettera colore)



8

8 PIVORACK

Adattatore per il fissaggio dei leggio a scaffali metallici. Perfetto per magazzini e punti vendita. Fornito con viti di fissaggio.

- SMCA412** - pivorack



9

9 BRACCIO SNODATO

Per utilizzo da scrivania. Si assembla con semplice aggancio al leggio a muro. Possibile agganciare sino a 2 leggio con 20 cartelline.

- SMCA413** - braccio snodato con morsetto



10

10 SUPPORTO MAGNETICO

Con 4 anelli in metallo nichelato. Da utilizzare in posizione orizzontale o verticale. Sottile e leggero, consente la visualizzazione e l'archiviazione di più documenti in un unico posto. Ideale per cartelline preforate formato A4. Dimensioni: 40 x 320 mm.

- SMCA790** - supporto magnetico



WALL ORGANIZER, PORTANOMI E PORTABADGE



WALL ORGANIZER

Portadocumenti e riviste a muro, struttura in polistirene, con scomparti orizzontali e verticali. Consegnati pronti all'uso con appositi fori per affissione (viti non incluse). Facilmente ampliabili per affiancamento. Disponibile anche nella versione per badge e cartellini.

- 6 SMCA500** - portabadge 24 scomparti 9,5 x 5,4 cm, dimensioni (l x p x h) 20 x 2,5 x 37,5 cm
- 5 SMCA501** - modulo verticale 50 scomparti A4, dimensioni (l x p x h) 54,5 x 13 x 112 cm. Scomparto: h 29,5 x l 23,5 x p 0,5 cm. Parte visibile 3 cm
- 1 SMCA502** - modulo orizzontale 6 scomparti A4, dimensioni (l x p x h) 31 x 8 x 50 cm. Scomparto: h 20 x l 30,5 x p 1,5 cm. Parte visibile 4,9 cm
- 2 SMCA504** - modulo verticale 6 scomparti A4, dimensioni (l x p x h) 23,5 x 8,5 x 71 cm. Scomparto: h 29,5 x l 22 x p 1,5 cm. Parte visibile 7 cm
- 3 SMCA506** - modulo verticale 20 scomparti A4, dimensioni (l x p x h) 54,5 x 10,5 x 86 cm. Scomparto: h 29,5 x l 23,5 x p 1 cm. Parte visibile 5 cm
- 4 SMCA508** - modulo verticale 25 scomparti A4, dimensioni (l x p x h) 27,5 x 13 x 112 cm. Scomparto: h 29,5 x l 23,5 x p 0,5 cm. Parte visibile 3 cm

Portanomi e portabadge

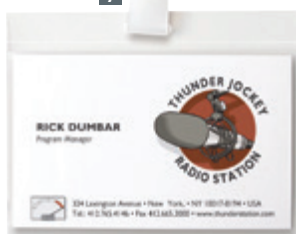
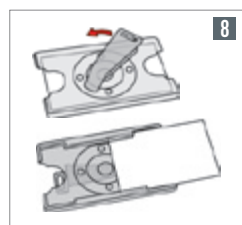

Accessori



11 CORDICELLA PER PORTA BADGE

Cordicella tonda universale per porta badge con gancio con molla e anello. Chiusura di sicurezza anti soffocamento. Colori: **L** lime **W** bianco **N** nero (disponibile solo in versione piatta)

SMCA311 - cordicella tonda Ø 5 mm

PORTABADGE RIGIDI

Offrono ideale protezione per carte personali o altre carte magnetiche. In due versioni: una utilizzabile con clip tradizionale (**codice SMCA290**) o comoda clip retraibile per il massimo comfort (**codice SMCA240**), l'altra con attacco rotante. Minimo ordinabile 10 pezzi/multipli.

- 7 SMCA305** - portabadge rigido (da utilizzare con clip), formato 91 x 68
- 8 SMCA300** - portabadge rigido con attacco rotante, formato 91 x 57

9 PORTANOME CON CLIP

Portanome in PVC trasparente con apertura superiore, dimensioni mm 95 x 75 (formato utile mm 90 x 60), attacco con clip. Minimo ordinabile 50 pezzi/multipli.

SMCA100 - portanome con clip

10 PORTABADGE ANTIBATTERICO

Realizzato in materiale plastico STERIFOLD (distrugge il 99,9% dei batteri entro 2 ore). Adatto all'uso in ospedali, laboratori, industrie farmaceutiche. Minimo ordinabile 10 pezzi/multipli.

SMCA432 - portabadge antibatterico, dimensioni 90 x 65 mm



CLIP PER PORTABADGE E PORTANOME

Minimo ordinabile 10 pezzi/multipli.

- 12 SMCA290** - clip in metallo
- 13 SMCA240** - clip portanome con cordicella in nylon autorientante da cm 60. Permette il fissaggio del badge a cinture, borse etc. per poi passarlo attraverso il lettore o mostrarlo senza staccarlo



1 PORTA POSTER MONO E BIFACCIALE

Porta poster da terra per interni, con struttura in metallo (silver) e cornice alluminio naturale. Montante quadrato. Cornice a scatto mm 25 angoli tondi cromati. Protezione in PVC antiriflesso. Base mm 380 x 380. Fornibile in versione monofacciale o bifacciale.

1 SMCT7274 - porta poster monofacciale altezza mm 1815, per foglio mm 700 x 1000

2 SMCT7276 - porta poster bifacciale altezza mm 1815, per foglio mm 700 x 1000



3 CORNICE A CAVALLETTO BIFACCIALE

Profilo mm 32 in anodizzato naturale, cavalletto bifacciale con angoli arrotondati. Stabilità massima alle gambe in metallo; molto resistente grazie al retro in acciaio.

SMCT32 - per foglio mm 500 x 700, dimensioni esterne mm 545 x 744 x 1120 h

SMCT33 - per foglio mm 700 x 1000, dimensioni esterne mm 745 x 925 x 1406 h

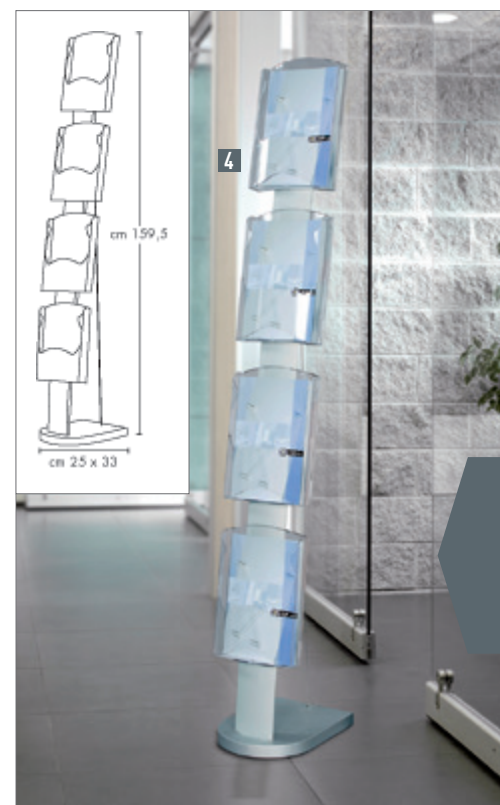

4 PORTADEPLIANT A4

Struttura in alluminio anodizzato, completa di 4 tasche (DIN A4) porta depliant in policarbonato trasparente antiurto, resistente ai raggi UV. Funzionale, leggero, stabile nella struttura, si monta e si smonta velocemente in pochi, semplici gesti. Dimensioni: base mm 250 x 330, altezza mm 1595. Peso kg 4,8.

TKPD104 - portadepliant 4 tasche formato A4 (mm 210 x 297)



5 LAVAGNA SCRIVIBILE A MURO

Lavagna scrivibile a muro, magnetica con fondo laccato. Cornice perimetrale in alluminio e vassoio porta pennarelli (A).

SMLT60 - dimensioni (b x h) mm 600 x 450

SMLT90 - dimensioni (b x h) mm 900 x 600

SMLT120 - dimensioni (b x h) mm 1200 x 900

SMLT150 - dimensioni (b x h) mm 1500 x 1000

SMLT180 - dimensioni (b x h) mm 1800 x 900

SMLT200 - dimensioni (b x h) mm 2000 x 1000

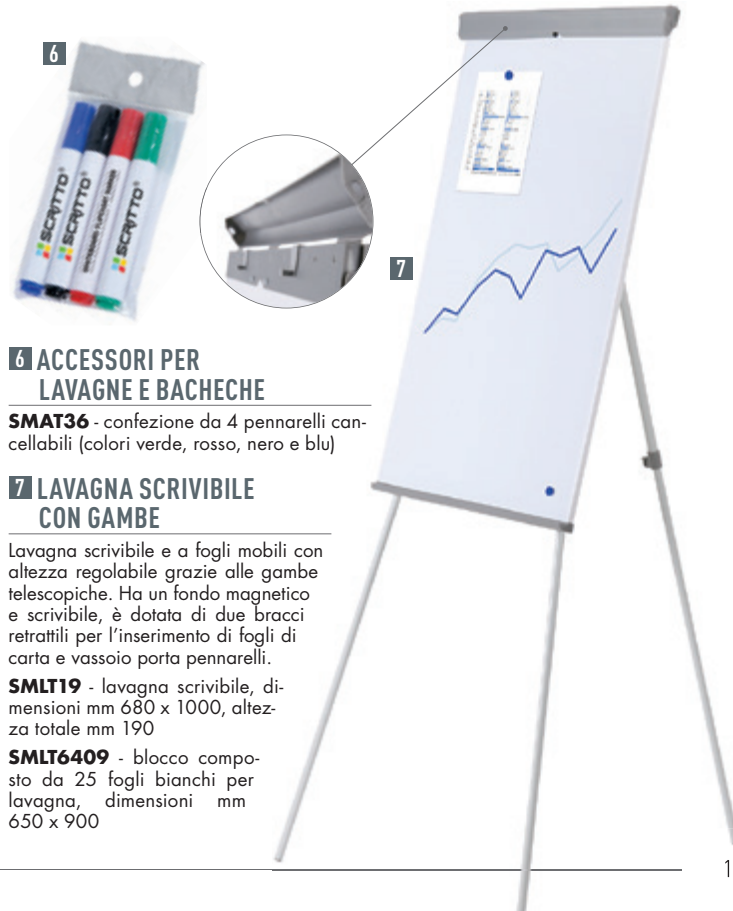

6 ACCESSORI PER LAVAGNE E BACHECHE

SMAT36 - confezione da 4 pennarelli cancellabili (colori verde, rosso, nero e blu)

7 LAVAGNA SCRIVIBILE CON GAMBE

Lavagna scrivibile e a fogli mobili con altezza regolabile grazie alle gambe telescopiche. Ha un fondo magnetico e scrivibile, è dotata di due bracci retrattili per l'inserimento di fogli di carta e vassoio porta pennarelli.

SMLT19 - lavagna scrivibile, dimensioni mm 680 x 1000, altezza totale mm 190

SMLT6409 - blocco composto da 25 fogli bianchi per lavagna, dimensioni mm 650 x 900



ESPOSITORE A PAVIMENTO

Espositore a pavimento completo di porta depiant multipla a 4 posti, disponibile in due versioni. Struttura in alluminio con profilo ellittico in alluminio anodizzato e base rettangolare in legno laccato (MDF) su piastra in metallo non visibile.

- 1 **SMET3254** - espositore formato A5 verticale, base mm 300 x 300, h mm 1085
- 2 **SMET3255** - espositore formato A4 verticale, base mm 300 x 300, h mm 1200



LEGGIO MONOFACCIALE CON BASE

Leggio a pavimento con cornice a scatto **posizionabile in orizzontale o verticale**, con profilo da mm 25 ed angolo tondo, disponibile in due versioni. Struttura in alluminio anodizzato e base rettangolare in legno laccato (MDF) su piastra in metallo non visibile.

- 3 **SMET6010** - leggio con cornice formato A4, dimensioni: base mm 350 x 300, h mm 1085
- 4 **SMET6011** - leggio con cornice formato A3, dimensioni: base mm 350 x 300, h mm 1100

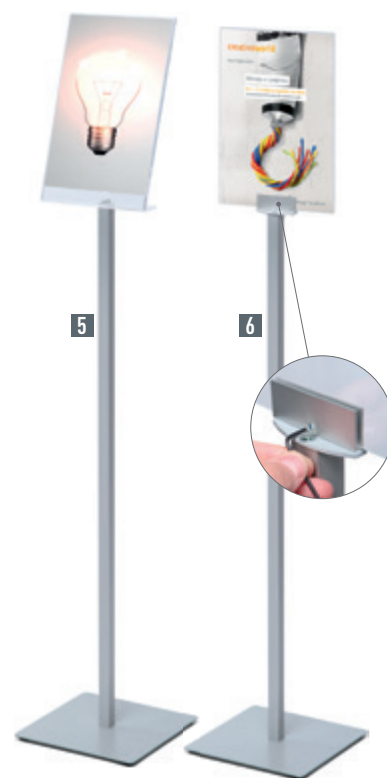

PIANTANA PORTA AVVISI DA PAVIMENTO, MONOFACCIALE E BIFACCIALE

Linea economica **per interni**, ottima stabilità. Struttura in metallo, pannello in plexiglass per grafica su carta. Base quadrata mm 260 x 260. Ideale per inserire messaggi e comunicazioni.

- 5 **SMET6020** - piantana porta avvisi formato A4 **monofacciale** inclinato, h mm 134
- 6 **SMET6021** - piantana porta avvisi formato A4 **bifacciale**, h mm 131

Totem per esterni

Struttura in alluminio anodizzato composta da due pali da interrare completi di tappi in ABS e pannelli in stampa digitale con **protezione anti UV lucida/opaca (da specificare in fase d'ordine)**.

I NOSTRI TOTEM SONO LA SOLUZIONE IDEALE PER TUTTE LE VOSTRE ESIGENZE COMUNICATIVE. ELEGANTI, SEMPLICI, VERSATILI, IL TOTEM POSSONO ESSERE COMPLETAMENTE PERSONALIZZATI, GRAZIE AI DIVERSI ELEMENTI MODULARI. GRAFICA INCLUSA. QUI IN BASSO RIPORTIAMO ALCUNI ESEMPI DI COMPOSIZIONE:



TOTEM COMPOSTO DA:
 • 2 PALI H 1800 mm DA INTERRARE
 • 1 TARGA DIMENSIONI 1000 x 300 mm
 • 3 TARGHE 1000 x 150 mm CIASCUNA



TOTEM COMPOSTO DA:
 • 2 PALI H 1800 mm DA INTERRARE
 • 1 TARGA DIMENSIONI 1000 x 200 mm
 • 4 TARGHE 1000 x 150 mm CIASCUNA



TOTEM COMPOSTO DA:
 • 2 PALI H 1800 mm DA INTERRARE
 • 1 PANNELLO 1000 x 1000 mm



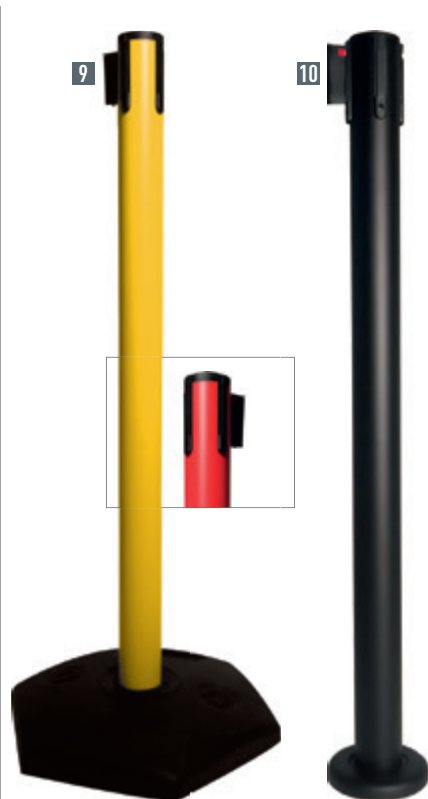

A RICHIESTA, NASTRO PERSONALIZZABILE DA ENTRAMBI I LATI CON LOGO AD UNO O PIU' COLORI

COLONNINA TENDINASTRO VERSIONE BASIC

Colonnine in acciaio spazzolato o verniciate nero opaco, dotate di sistema tendinastro autofrenante. Ottimo rapporto qualità/prezzo. Ideali per migliorare la gestione delle file negli uffici e nei negozi o nei grandi eventi come fiere e manifestazioni. Massima stabilità garantita dalla struttura robusta dal peso di kg 10. Altezza 1 metro. Diametro della base 360 mm.

Dimensioni nastro: h 48 mm x 3 m. Nastro personalizzabile a richiesta da entrambi i lati con logo ad uno o più colori.

- 1 **TSB512.** - colonnina tendinastro colore nero opaco, dimensioni: base Ø 360 x 1000 mm altezza (abbinare la lettera colore nastro)
- 2 **TSB511.** - colonnina tendinastro in acciaio spazzolato, dimensioni: base Ø 360 x 1000 mm altezza (abbinare la lettera colore nastro)

COLONNINA TENDINASTRO VERSIONE PLUS

Eleganti colonnine con base piatta, disponibili in 5 finiture e 8 colorazioni di nastro, dotate di sistema tendinastro autofrenante. Ideali per migliorare la gestione delle file negli uffici e nei negozi o nei grandi eventi come fiere e manifestazioni. Base e montante in metallo con finitura nei colori: acciaio spazzolato, nero opaco, rosso, giallo, bianco. Colorazioni di nastro: rosso, blu, nero, bianco, verde, giallo, arancio, giallo/nero, bianco/rosso. Altezza 1010 mm. Diametro della base 350 mm. Peso totale kg 10,5. **Dimensioni nastro: h 48 mm x 3 m,** con clip di sicurezza.

- 3 **TSP201.** - colonnina tendinastro in acciaio spazzolato (abbinare lettera colore nastro - vedi tabella)
- 4 **TSP202.** - colonnina tendinastro colore nero opaco (abbinare lettera colore nastro - vedi tabella)
- 5 **TSP203.** - colonnina tendinastro colore rosso (abbinare lettera colore nastro - vedi tabella)
- 6 **TSP204.** - colonnina tendinastro colore giallo (abbinare lettera colore nastro - vedi tabella)
- 7 **TSP205.** - colonnina tendinastro colore bianco (abbinare lettera colore nastro - vedi tabella)
- 8 **TSP206.** - colonnina tendinastro in acciaio cromato lucido (abbinare lettera colore nastro - vedi tabella)



COLONNINA TENDINASTRO VERSIONE OUTDOOR

Colonnine in PVC con base in plastica riciclata nera, dotate di sistema tendinastro autofrenante. Robuste e resistenti. Ideali per utilizzo all'esterno e in ambito industriale. Altezza 1000 mm. Diametro della base 350 mm. Peso totale kg 8,5. **Dimensioni nastro: h 48 mm x 3,5 m.**

- 9 **TSO100BR** - colonnina tendinastro colore rosso, con nastro bianco/rosso
- TSO100YN** - colonnina tendinastro colore giallo, con nastro giallo/nero
- 10 **Versione con base tassellabile da esterno.** Altezza 1000 mm. Lunghezza nastro: 3,5 m.
- TSO110N** - colonnina tendinastro colore nero opaco, con nastro nero

COLORI NASTRI PER COLONNINE VERSIONE BASIC E VERSIONE PLUS



i LE COLONNINE VERSIONE BASIC, PLUS E OUTDOOR VENGONO FORNITE COMPLETE DI TESTINA CON NASTRO NEL COLORE SCELTO E IDENTIFICATO DA UNA LETTERA. PER ORDINARE LA COLONNINA CON TESTINA SENZA NASTRO AGGIUNGERE LA LETTERA X AL POSTO DELLA LETTERA IDENTIFICATRICE DEL COLORE.



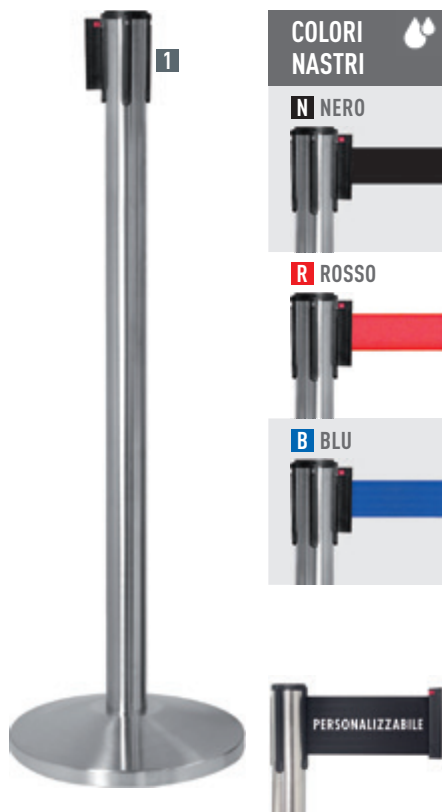

1 NASTRO ALTEZZA 8 CM, IDEALE PER LA PERSONALIZZAZIONE (RICHIEDI PREVENTIVO)

1 COLONNINE CON NASTRO ALTEZZA 8 CM

Colonnina tendinastro con finitura in acciaio spazzolato. Altezza 1010 mm. Diametro della base 360 mm. Peso totale kg 10. Nastro altezza 8 cm - **ideale per la personalizzazione** - lunghezza 3 m.

Colori nastro: **N** nero **R** rosso **B** blu

TSP800 - colonnina tendinastro con nastro h 8 cm (abbinare lettera colore nastro) - grafica esclusa



2 COLONNINA TENDINASTRO LEGGERA, ECONOMICA E DI FACILE UTILIZZO.

2 COLONNINA TENDINASTRO VERSIONE BUDGET

Colonnina tendinastro leggera ed economica. Sistema tendinastro autofrenante. Design elegante con finitura nera opaca. Uso indoor, ideale per gestire i flussi di persone. Altezza 925 mm. Diametro della base 320 mm. Peso totale kg 8,3. Nastro: 2,5 m x 4,6 cm h, colore nero, dotato di clip di sicurezza.

TSE320N - colonnina tendinastro leggera ed economica, altezza 92,5 cm con nastro da 2,5 m



7 COLONNINA EXTRA ALTA

Finitura in acciaio spazzolato. Altezza m 2,20. Peso kg 12. Con nastro colore nero lunghezza m 3. Ideale per rendere visibili informazioni a distanza tramite i porta avvisi TSA21V, TSA21O, TSA29V (acquistabili separatamente).

TSBX220N - colonnina in acciaio spazzolato altezza 220 cm con nastro nero da 3 m

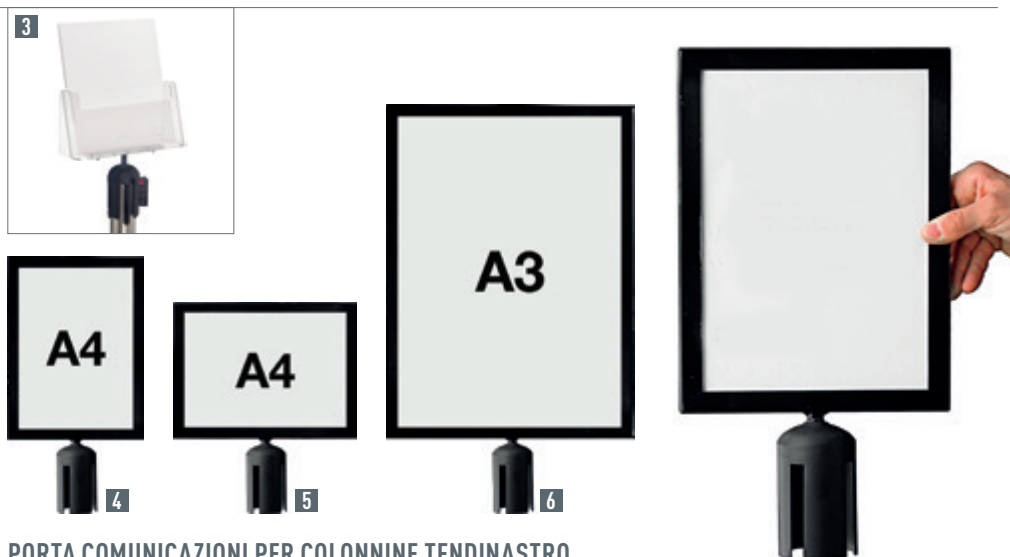

PORTA COMUNICAZIONI PER COLONNINE TENDINASTRO

Porta avvisi per colonnine tendinastro disponibili in diversi formati. Composto da sostegno in metallo nero e tasca in plexiglass altamente trasparente. Per comunicazioni intercambiabili in carta o cartoncino.

3 TSAPO5 - porta depliant 1 tasca formato A4 con supporto in ABS nero per colonnina

4 TSA21V - porta avvisi formato A4 verticale

5 TSA21O - porta avvisi formato A4 orizzontale

6 TSA29V - porta avvisi formato A3 verticale



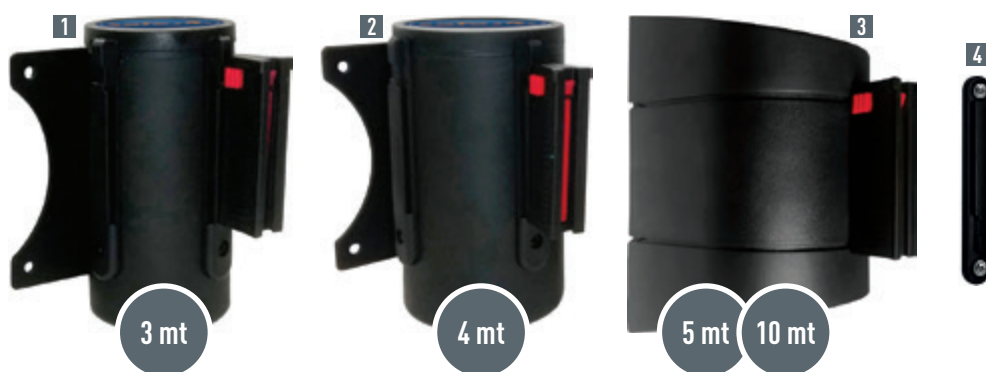

TESTINE A MURO

Avvolgitore a muro con nastro estensibile: con meccanismo auto frenante con clip di chiusura di sicurezza per controllo accessi e attacco a muro. Da abbinare con la clip ricevente a muro o colonnine tendinastro. Vari colori e lunghezze.

- 1 **TST300**. - testina a muro verniciata nero opaco, **dimensioni nastro h 48 mm x 3 m**. Colore nastro: blu, nero, rosso, verde, bianco, bianco/rosso, giallo/nero
- 2 **TST400**. - testina a muro verniciata nero opaco, **dimensioni nastro h 48 mm x 4 m**. Colore nastro: blu, nero, rosso
- 3 **TST500**. - testina a muro verniciata nero opaco, **dimensioni nastro h 48 mm x 5 m**. Colore nastro: nero, bianco/rosso, giallo/nero
- TST100**. - testina a muro verniciata nero opaco, **dimensioni nastro h 48 mm x 10 m**. Colore nastro: nero, bianco/rosso, giallo/nero
- 4 **TSTC** - clip ricevente a muro in ABS

COLORI NASTRI PER TESTINE A MURO



TESTINE A MURO MAGNETICHE

Testine a muro con retro magnetico per il fissaggio su superfici in metallo senza l'uso di viti con nastro nero da m 3 e m 5 dotato di terminale magnetico per il fissaggio a superfici idonee; togliendo il magnete dal nastro si può fissare al muro tramite la clip ricevente **TSTC**.

- 5 **TSTM03** - testina a muro magnetica con nastro nero da 3 metri
- 6 **TSTM05** - testina a muro magnetica con nastro nero da 5 metri

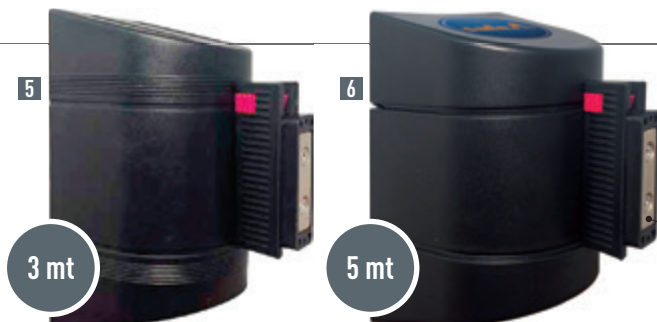

7 TESTINA TENDINASTRO CON SUPPORTO MAGNETICO

La soluzione ideale per dividere gli spazi con un elemento dall'aspetto gradevole e funzionale! Progettata per suddividere scaffali e delimitare aree e passaggi all'interno dei magazzini, si compone di un supporto con magneti inclusi e testina con nastro da 5 o 10 metri (colore bianco/rosso o giallo/nero). Il nastro in polipropilene è estensibile, resiste all'esterno in luoghi con difficili condizioni atmosferiche e ha un sistema di riavvolgimento lento per una maggior protezione e sicurezza. L'attacco magnetico permette il posizionamento su tutte le superfici metalliche. Il terminale per l'aggancio del nastro è da aggiungere a parte.

Il sistema è composto dai seguenti elementi:

- TSMS05**. - testina con nastro da 5 mt (in alternativa è possibile scegliere il codice TSMS10. - testina con nastro da 10 mt)
- TSMS17M** - confezione da 2 magneti per TSMS15
- TSMS16** - terminale a muro
- TSMS16M** - confezione da 3 magneti per TSMS16





Sistema modulare a nastro



I MAGNETI RENDONO I SUPPORTI ADATTI AD ESSERE FISSATI SU SUPERFICI IN METALLO!

TESTINE TENDINASTRO

Realizzate in polipropilene, resistenti all'esterno anche con difficili condizioni atmosferiche. Sistema di riavvolgimento lento, nastro tessile plastificato da 5 e 10 mt. Colori:

NY testina gialla con nastro giallo/nero

RW testina rossa con nastro bianco/rosso

1 TSMS05 - testina con nastro da 5 mt. Peso 750 gr

2 TSMS10 - testina con nastro da 10 mt. Peso 975 gr

ACCESSORI

3 TSMS15 - supporto a muro (testina esclusa)

4 TSMS16 - terminale a muro

5 TSMS17M - confezione da 2 magneti per TSMS15

6 TSMS16M - confezione da 3 magneti per TSMS16

COLONNINE MODULARI

Colonnine in acciaio verniciato Ø 70 mm. Possono essere avvitate alla base formando una colonnina da 81 oppure da 34,5 cm sulla quale aggiungere una testina a nastro, un portadépliant o altre colonnine (per una maggiore altezza). Colori: **R** rosso **Y** giallo.

7 TSMS27 - colonnina cm 81, peso 375 gr

8 TSMS28 - colonnina cm 34,5, peso 250 gr

9 TSMS29 - base quadrata per una maggiore stabilità e resistenza, con protezioni in gomma agli angoli. Dimensioni mm 380 x 380, h 18, peso 6,5 kg

10 ADATTATORE PER CONI

Adattatore in materiale plastico resistente alle intemperie, per applicare le testine a nastro o i portadocumenti su coni stradali per formare barriere e dare informazioni. Utilizzabile con le testine a nastro da 5 o da 10 metri.

TSMS51 - cono adattatore Ø mm 91 x 120 h

PORTA DOCUMENTI

Accessorio in acciaio disponibile in formato A4 e A3. Avvitabile direttamente sulle colonnine o sull'adattatore TSMS51. Si raccomanda l'utilizzo delle cartelle trasparenti in metalcristallo per riporre gli avvisi nei porta documenti A4 e A3.

11 TSMSA4V - porta avvisi formato A4 verticale

TSMSA4O - porta avvisi formato A4 orizzontale

TSMSA3V - porta avvisi formato A3 verticale

TSMSA3O - porta avvisi formato A3 orizzontale

12 TSMS41V - cartella trasparente formato A4 verticale

TSMS41O - cartella trasparente formato A4 orizzontale

TSMS31V - cartella trasparente formato A3 verticale

TSMS31O - cartella trasparente formato A3 orizzontale

Esempi di configurazione

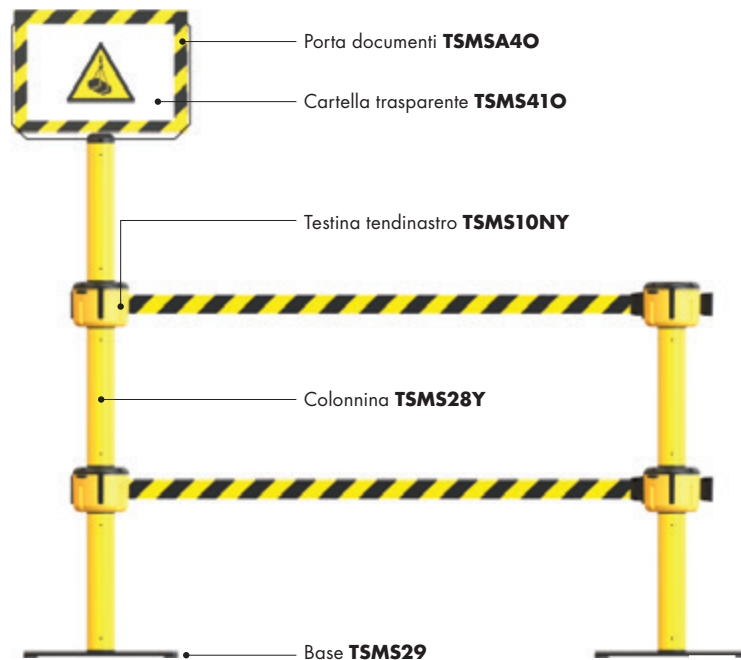
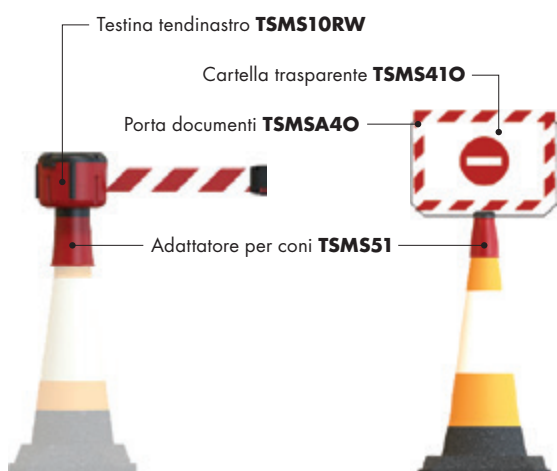



COLONNINE

Colonnine in acciaio eleganti e comode per ambienti lussuosi ed importanti. Disponibili in due finiture. Dimensioni: base Ø 33 cm x 100 h, peso 9 kg, Ø colonnina mm 50.

- 1 **TDV201** - colonnina finitura ottone
- 2 **TDV301** - colonnina finitura cromo



CORDONE LISCIO

Cordone liscio Ø mm 35, lunghezza 1,6 metri, rivestito con elegante tessuto in velluto colore rosso o nero.

- 3 **TDVC160** - cordone in velluto nero con gancio cromo
- 4 **TDVC161** - cordone in velluto rosso con gancio ottone



5 CORDONE A TRECCIA

Cordone a treccia in poliestere colorato Ø mm 28, lunghezza 2 metri. Ganci di attacco in due finiture (cromo e ottone). Colori: **N** nero (RAL 9004) **R** rosso (RAL 3020) **B** blu (RAL 5005)

- TDVC.** - cordone a treccia con attacchi cromo (abbinare lettera colore)
- TDVO.** - cordone a treccia con attacchi ottone (abbinare lettera colore)



ATTACCO A MURO

- 6 **TDVA202** - attacco a muro ottone
- 7 **TDVA302** - attacco a muro cromo

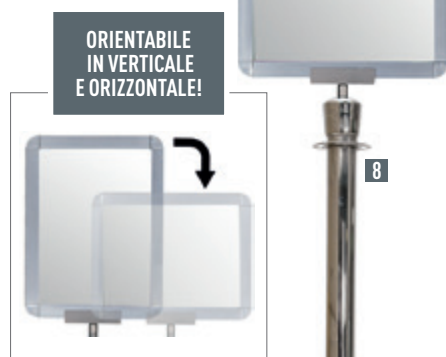
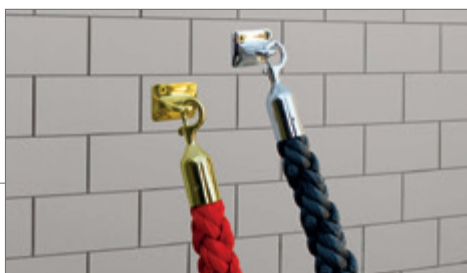

8 CORNICE IN ALLUMINIO PER COLONNINE

Cornice in alluminio con protezione frontale trasparente in PVC formato A4 orientabile (orizzontale e verticale). Si applica sulle colonnine senza l'ausilio di accessori. A richiesta fornibile anche nel formato A3 (297 x 420 mm) orientabile.

- CNV4A** - cornice portafogli A4 (210 x 297 mm), orientabile

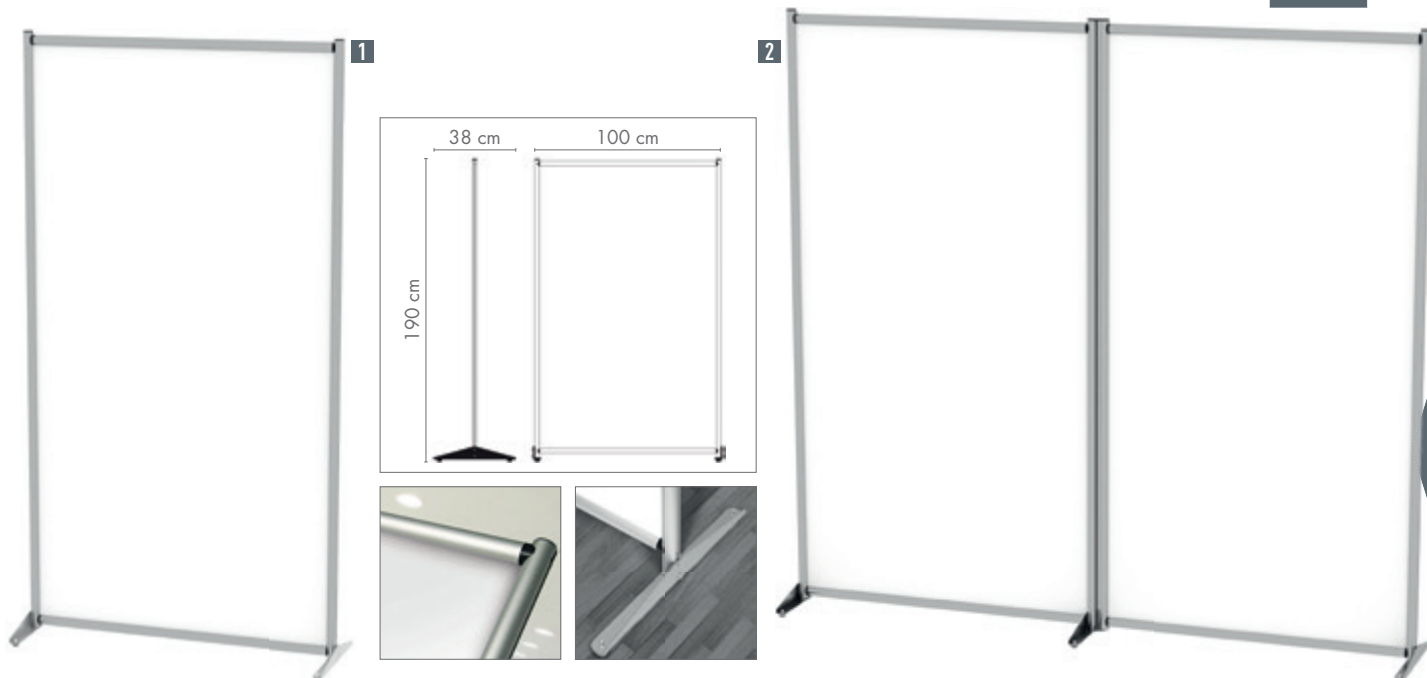

PANNELLI DIVISORI AUTOPORTANTI SINGOLI E DOPPI TRASPARENTI

Struttura in alluminio anodizzato silver Ø 30 mm con piedini fissi in metallo. Superficie in policarbonato alveolare semi-trasparente. Disponibili opzionali kit ruote con sistema frenante.

1 TSPW190 - pannello divisorio singolo in policarbonato semi-trasparente, cm 100 x 190 x 38 (l x h x p)

TSPW180KR - kit ruote per pannello singolo opzionale

2 TSPW200 - pannello divisorio doppio in policarbonato semi-trasparente, cm 204 x 190 x 38 (l x h x p)

TSPW200KR - kit ruote per pannello doppio opzionale



3 KIT BANNER PROMOZIONALE PER COLONNINE



Struttura composta da doppio aggancio in ABS nero con barra superiore e inferiore in alluminio anodizzato silver, 2 attacchi laterali regolabili in ABS nero per tensionamento banner. Banner personalizzabile in PVC non incluso (da ordinare separatamente). Applicabile a tutte le colonnine.

TSKB11 - kit banner per colonnine tendinastro (solo struttura, banner escluso)

TSKB11STM - stampa digitale monofacciale su banner 1100 x 850 mm

TSKB11STB - stampa digitale bifacciale su banner 1100 x 850 mm



4 PANNELLI DIVISORI SINGOLI



Pannelli divisori autoportanti singoli composti da struttura in alluminio anodizzato silver e forniti con piedini fissi in metallo verniciati a polveri. Superficie stampabile in forex da 6 mm bianco o nero.

TSPW180W - pannello divisorio singolo neutro bianco, mm 1000 x 1800

TSPW180KR - kit ruote carrellate per pannello singolo

TSPWST - stampa grafica digitale per pannelli divisori singoli

TSPWPS - pellicola adesiva scrivibile per **TSPW180W**

SMAT36 - confezione da 4 pennarelli cancellabili (vedi pagina 179)



SEGNALETICA D'AMBIENTE

COS'È LA SEGNALETICA D'AMBIENTE?

Ovunque vi sia la necessità di condurre il visitatore nel punto desiderato, sarà necessario predisporre un insieme di pannelli segnaletici legati da un'unica filosofia progettuale; dovremo cioè affidarci ad un impianto di segnaletica ambientale.

DOVE VIENE UTILIZZATA?

La segnaletica d'ambiente viene utilizzata nel settore civile, industriale, sanitario pubblico e privato. Forniamo segnaletica per aziende ed uffici privati, municipi, centri civici ed enti pubblici in generale, ospedali e comunità, alberghi, università e biblioteche. I nostri prodotti a catalogo, integrati dai prodotti speciali, ci consentono di coprire tutte le esigenze progettuali.

DESIGN & SYSTEM

Design & System offre una gamma completa di soluzioni per la segnaletica d'ambiente, per interni ed esterni. Realizziamo impianti innovativi e personalizzati, comunicando e orientando il visitatore secondo le specifiche esigenze di ogni ambiente e nel rispetto dello stile architettonico. La versatilità e l'eleganza dei nostri sistemi ci permettono di renderli gradevoli, raffinati ma soprattutto funzionali. Design & System è l'opportunità perfetta per comunicare l'immagine della tua azienda.



1. PROGETTO

La prima fase del lavoro comprende la scelta dei supporti, dei colori, dell'impostazione grafica, dei testi e dei simboli. Il posizionamento dei segnali nelle planimetrie ed i fotomontaggi potranno dare l'idea degli ambienti completamente allestiti.



2. PRODUZIONE

Un reparto interamente dedicato e l'esperienza delle persone che vi lavorano, assicurano da più di 50 anni un elevato livello di servizio. Il magazzino e l'organizzazione secondo gli standard ISO 9001:2000 garantiscono la qualità del sistema aziendale.



3. INSTALLAZIONE

Una volta prodotti, i segnali verranno installati presso la vostra azienda secondo le indicazioni di progetto. Il nostro personale specializzato è dotato di tutti gli strumenti (DPI) e mezzi necessari ad operare correttamente e in totale sicurezza.



4. AGGIORNAMENTO

La modularità dei sistemi, prodotti industrialmente, consente in ogni momento di aggiornare, sostituire o aggiungere nuovi elementi. Una memoria del progetto originario ci consente di rimanere fedeli alla scelta dei colori, dell'impostazione grafica, dei testi e simboli fatti precedentemente.

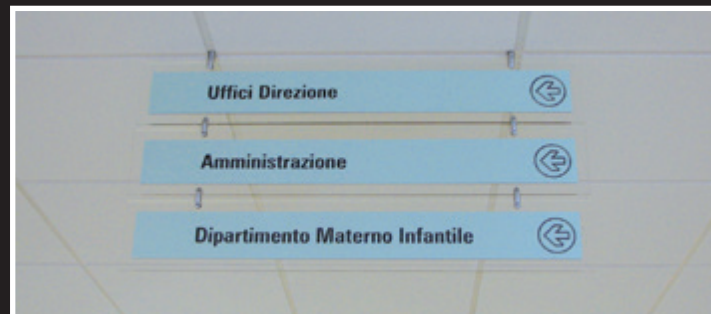
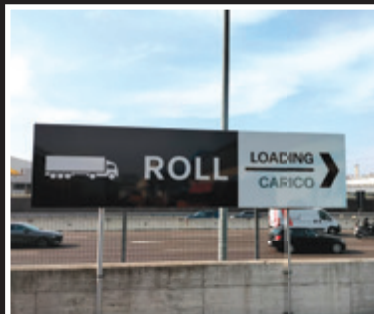
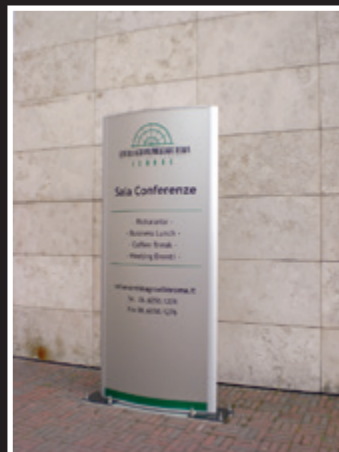
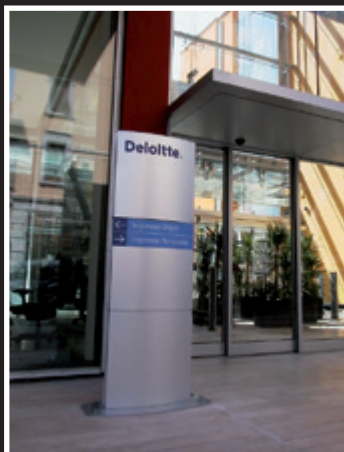



INSEGNE

Scritte ed insegne luminose scatolate realizzate sia interamente in materiale plastico tipo metacrilato che misto metacrilato e metallo come acciaio INOX o alluminio. Il tipo di illuminazione può variare da quella tradizionale a neon a quella innovativa a LED.

Le caratteristiche generali sia illuminotecniche che decorative variano e vengono concordate di volta in volta con il cliente in funzione dell'esigenza.

Ogni proposta è quindi da considerarsi come un progetto "chiavi in mano" secondo i consueti principi di eccellenza del prodotto e del servizio.

Per questo prevediamo che ogni soluzione generalmente necessiti di un sopralluogo di un nostro tecnico, sia per la valutazione e la scelta della tipologia del prodotto che dell'installazione.



ARTICOLI PER MAGAZZINI E LOGISTICHE

SEGNALETICA DA PAVIMENTO ADESIVA SAFE IN®	199-200
NASTRI SEGNALETICI.....	201-202
NASTRI ANTI-EFFRAZIONE E PER IMBALLI.....	203-204
ACCESSORI E BOLLINI IN CARTA COLORATI	204
CAVALLETTI SEGNAPERICOLO	205
ETICHETTE MAGNETICHE	206
SUPPORTI BIFACCIALI FLESSIBILI FOLD.....	207
NUMERI E LETTERE PER SCAFFALATURE	208-209
SISTEMI DI MARCATURA A VERNICE E TRACCIALINEE SAFE IN®.....	210-211
DIME IN CARTONE E IN ALLUMINIO	212-213
SEGNALI, SCRITTE E BOLLI AUTOADESIVI DA PAVIMENTO.....	214-215
PANNELLI RETTORIFLETTENTI E PROFILI RIFRANGENTI.....	215
PARACOLPI IN EVA ESPANSA SAFE IN® E IN POLIURETANO	216-217
PARACOLPI GRANDE FORMATO E PER COLONNE.....	218-219
BARRIERE IN POLIETILENE PER AREE INDUSTRIALI	220-221
SISTEMI DI PROTEZIONE PER AREE INDUSTRIALI E MACCHINARI.....	222-225
SCALE, PONTEGGI E SGABELLI	226-229
CARRELLI, BILANCE E PANNELLI PORTA ATTREZZI	230
TAVOLI DA LAVORO E CASSETTIERE	231
REGGE, TENDIREGGE E POLIETILENE A BOLLE D'ARIA	232
TRANSPALLET, SALDATRICI E SACCHETTI	233
BUSTE PER MAGAZZINI E BAULI	234
CONTENITORI MULTIUSO E CASSETTI BASCULANTI	235-236
PALLET, CARGOPALLET E CONTENITORI IN LAMIERA.....	237-238
ARTICOLI PORTAUTENSILI	239
TAGLIERINI DI SICUREZZA.....	240-241
SIGILLI DI SICUREZZA.....	242-243
MARCATORI INDUSTRIALI	244-245
TORCE E LAMPADE DA LAVORO.....	246-247
LUCI DA CANTIERE	248
VENTILATORE A TURBINA E GENERATORI DI ARIA CALDA.....	249
SISTEMI DI ILLUMINAZIONE PER AREE ESTESE.....	249
SEGNALATORI LUMINOSI E SONORI.....	250





safe in®

SOLUZIONI PER UNA LOGISTICA EFFICIENTE

Scopri la gamma di prodotti Safe In®, studiati per organizzare e gestire al meglio magazzini e logistiche.

PAG. 199



PAG. 200



PAG. 210



PAG. 212



PAG. 216



PAG. 220





1

FORNIBILI NEI SEGUENTI COLORI:

- W** BIANCO
- R** ROSSO
- Y** GIALLO
- B** BLU
- G** VERDE
- NY** NERO-GIALLO
- RW** ROSSO-BIANCO



ROTOLO GIALLO ALTEZZA 75 MM



NASTRI DA PAVIMENTO ADESIVI SAFE IN®

Nastri adesivi colorati per la marcatura di pavimenti e segnalazione di pericolo. Ideali per delimitazione di aree e corsie all'interno di aree di stoccaggio e produttive. Realizzati in PVC plastificato di alta qualità, spessore 0,16 mm. Adesivo sensibile alla pressione, a base gomma, molto tenace, eccellente resistenza meccanica, resistenza all'abrasione e all'umidità, ottima adattabilità. Resistenti a pulitura, traffico intenso e calpestio. Indicati per ambienti interni ed esterni protetti. Conformi alla Direttiva europea 2000/53 CE (privo di piombo, cromo VI, mercurio, cadmio). Si applicano su superfici pulite ed asciutte, temperatura minima di applicazione: 10°C.

- 1** **NTS50.** - rotolo adesivo, lunghezza m 33, altezza 50 mm (specificare lettera colore)
- NTS51NY** - rotolo adesivo giallo/nero, lunghezza m 33, altezza 50 mm
- NTS51WR** - rotolo adesivo bianco/rosso, lunghezza m 33, altezza 50 mm
- 2** **NTS75Y** - rotolo adesivo, lunghezza m 33, altezza 75 mm, colore giallo



NASTRI DI QUALITÀ SUPERIORE MOLTO RESISTENTE, IDEALE PER AREE INTERNE AD INTENSO TRAFFICO.

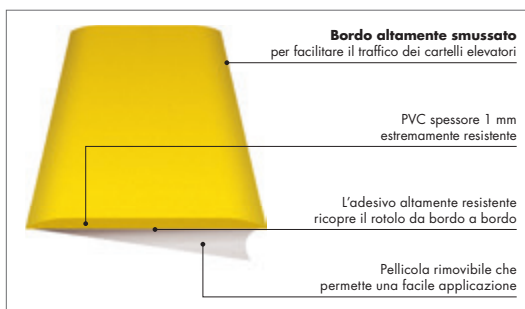

3 NASTRI DA PAVIMENTO ADESIVI SAFE IN® QUALITÀ PREMIUM

Nastri da pavimento in PVC, molto resistenti, con strato superiore gofrato e antiscivolo, ideali per magazzini e aree produttive. Lunga durata, spessore 1 mm. Materiale omogeneo, non si scolora. Adesivo permanente molto tenace. Si staccano in un solo pezzo nel caso fosse necessaria la rimozione. Bordi leggermente smussati per minimizzare l'attrito delle ruote di muletti, transpallet. Rapida applicazione. Uso interno, idonei per codifica colore e metodologie Lean o 5S. **Lunghezza rotolo 30 metri.** Si applicano su superfici pulite ed asciutte.

- DMS50.** - rotolo altezza 50 mm (specificare lettera colore)
- DMS75.** - rotolo altezza 75 mm (specificare lettera colore)
- DMS100.** - rotolo altezza 100 mm (specificare lettera colore)



FORNIBILI IN 3 ALTEZZE DIVERSE

FORNIBILI NEI SEGUENTI COLORI:

- W** BIANCO
- R** ROSSO
- Y** GIALLO
- B** BLU
- G** VERDE
- NY** NERO-GIALLO





LA SICUREZZA AL PRIMO POSTO

La segnaletica da pavimento adesiva è un elemento indispensabile per ridurre i rischi in magazzini, fabbriche e officine. Le strisce e i marcatori adesivi, consentono infatti di delimitare uno spazio (zone pedonali, spazi di stoccaggio, ecc.) e guidare la circolazione delle corsie dei magazzini. Per questo motivo è importante che la segnaletica da pavimento dei vostri spazi sia sempre visibile. Nel caso fosse rovinata, affidatevi ai prodotti Safe In®: semplici da applicare e durevoli nel tempo, sapranno garantire un ambiente sicuro ai vostri lavoratori.



MARCATORI PER PALLET, DISCHI E ORME SAFEIN®

Marcatori in PVC sovrallaminato molto resistenti. Spessore 0,8 mm, ideali per segnalare, delimitare aree pallet e per indicare camminamenti, percorsi a magazzino e in aree produttive. Lo strato protettivo superiore assicura una maggiore durata.

Colori: **R** rosso **Y** giallo **B** blu **G** verde

- 1 **DMX3**. - confezione 10 delimitatori adesivi per pallet a X, 300 x 300 mm
- 2 **DMT3**. - confezione 10 delimitatori adesivi per pallet a T, 300 x 200 mm
- 3 **DML2**. - confezione 10 delimitatori adesivi per pallet a L, 200 x 200 mm
- 4 **DMD24**. - confezione 20 orme 240 x 90 mm
- 5 **DMF10**. - confezione 20 frecce 100 x 65 mm
- 6 **DMD05**. - confezione 20 dischi adesivi diametro 50 mm
- DMD09**. - confezione 20 dischi adesivi diametro 90 mm



7 STRISCE PER REALIZZAZIONE ATTRAVERSAMENTO PEDONALE SAFEIN®

Attraversamento pedonale in PVC sovrallaminato molto resistente al calpestio. Spessore 0,8 mm. Ideale per segnalare aree di passaggio pedoni in maniera visibile, sicura e durevole. Applicazione facile e veloce su superfici pulite ed asciutte. Composto da 2 codici: uno per la striscia nera, uno per la striscia bianca.

DMP300N - striscia nera adesiva, dimensioni 300 mm x 1m

DMP300W - striscia bianca adesiva, dimensioni 300 mm x 1m



8 TASCHE PROTETTIVE PER PAVIMENTO SAFEIN®

Tasche in PVC con bordo colorato. Ideali per informazioni, istruzioni, codifica colore, assicurano la massima protezione ai vostri messaggi. Versatili e di facile applicazione.

Colori: **W** bianco **N** nero **Y** giallo **B** blu **G** verde

DMTA4. - confezione 10 tasche protettive formato A4



Segnaletica da pavimento per marcatura orizzontale

Ideale per delimitare aree, passaggi, scaffalature di magazzino, uscite e attrezzature di sicurezza. In poliestere adesivo con lamina protettiva poliestere. **Ottima resistenza all'abrasione, resiste al passaggio di muletti, transpallet senza sollevarsi o strapparsi.** La superficie, resistente alle macchie e al calpestio, si può pulire con comuni detergenti. Se necessario, possono essere facilmente rimossi in un unico pezzo senza lasciare residui di collante sul pavimento. **Spessore 0,20 mm.** Temperatura minima di applicazione: 5°C. Raccomandato per uso interno.

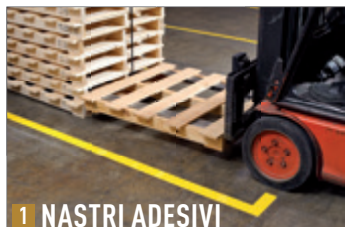

1 NASTRI ADESIVI

NBN50. - nastro adesivo da pavimento, lunghezza m 30, altezza mm 50, colori vari

NBN75. - nastro adesivo da pavimento, lunghezza m 30, altezza mm 75, colori vari

NBN100. - nastro adesivo da pavimento, lunghezza m 30, altezza mm 100, colori vari

Colori: **W** bianco **R** rosso **Y** giallo
B blu **G** verde **YN** giallo/nero
WN bianco/nero **WR** bianco/rosso



2 CERCHI ADESIVI IN ROTOLO

NBC100. - cerchi adesivi in rotolo (300 pezzi), dimensioni: Ø mm 100, colori vari
 Colori: **W** bianco **R** rosso **Y** giallo **B** blu **G** verde

3 FRECCHE ADESIVE

NBF50. - frecce adesive in confezione da 100 pezzi, dimensioni: mm 50 x 125, colori vari

NBF75. - frecce adesive in confezione da 100 pezzi, dimensioni: mm 75 x 200, colori vari

NBF100. - frecce adesive in confezione da 100 pezzi, dimensioni: mm 100 x 250, colori vari
 Colori: **W** bianco **R** rosso **Y** giallo **B** blu **G** verde

4 ANGOLI A "L" ADESIVI

In confezione da 20 pezzi.

NBK127. - angoli adesivi mm 51 x 127

NBK203. - angoli adesivi mm 76 x 203

Colori: **W** bianco **R** rosso **Y** giallo **B** blu **G** verde

5 DIVISORI A "T" ADESIVI

In confezione da 20 pezzi.

NBD127. - divisori adesivi mm 51 x 127

NBD203. - divisori adesivi mm 76 x 203

Colori: **W** bianco **R** rosso **Y** giallo **B** blu **G** verde

6 DIVISORI A "+" ADESIVI

In confezione da 20 pezzi.

NBM127. - divisori adesivi mm 51 x 127

NBM203. - divisori adesivi mm 76 x 203

Colori: **W** bianco **R** rosso **Y** giallo **B** blu **G** verde

7 ORME ADESIVE

NBP89. - orme adesive in confezione da 10 pezzi (5 destri e 5 sinistri), mm 254 x 89

Colori: **W** bianco **R** rosso **Y** giallo **B** blu **G** verde



4



5



6

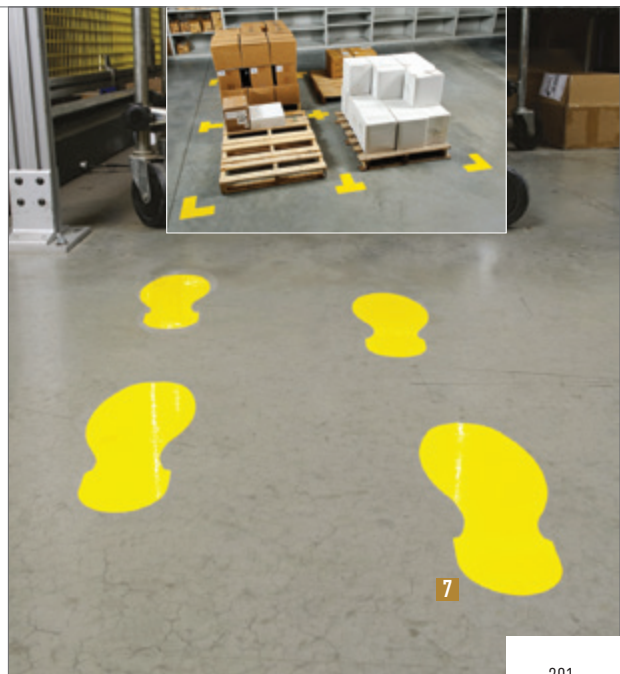

7



NASTRI SEGNALETICI PER UTILIZZI VARI



1 NASTRI AUTOADESIVI

Realizzati in gomma con supporto in PVC. Nastri da metri 60, altezza mm 50 in due colorazioni: bianco/rosso e giallo/nero in due orientamenti diversi. **Spessore 53 micron.**

- NP1701** - nastro a strisce bianco/rosso DX
- NP1702** - nastro a strisce bianco/rosso SX
- NP1711** - nastro a strisce giallo/nero DX
- NP1712** - nastro a strisce giallo/nero SX



2 NASTRI AUTOADESIVI RIFRANGENTI

Realizzati in pellicola rifrangente con tecnologia a microsferi di vetro, serigrafata a losanghe. Pellicola con adesivo permanente sensibile alla pressione adatta a superfici metalliche, lisce e/o leggermente curve. Nastri da metri 22,5, altezza mm 50. **Spessore 118 micron con tolleranza di ± 4 micron.**

- NR0501** - nastro a strisce bianco/rosso DX
- NR0502** - nastro a strisce bianco/rosso SX
- NR0511** - nastro a strisce giallo/nero DX
- NR0512** - nastro a strisce giallo/nero SX



3 NASTRI IN POLIETILENE

A strisce diagonali bianco/rosso o giallo/nero, per delimitazione aree di lavoro o zone pericolose. Confezione: scatola dispensatrice di cartone. Altezza del nastro mm 70, **spessore 30 micron.**

- NS700** - rotolo m 500, colore bianco/rosso
- NS701** - rotolo m 500, colore giallo/nero
- NS703** - rotolo m 200, colore bianco/rosso
- NS704** - rotolo m 200, colore giallo/nero



4 NASTRO RIFRANGENTE

A strisce diagonali bianco/rosso per delimitazione di aree di lavoro o zone pericolose. Visibilità notturna fino a m 200. Fattore di luminosità 15/40 candele/m². Stampato su un lato. **Spessore 50 micron.**

- NSR250** - rotolo m 250, altezza mm 75, colore bianco/rosso

5 NASTRI DA INTERRARE IN POLIETILENE

Altezza mm 100, lunghezza m 200, **spessore 40 micron.**
A richiesta in altezza mm 200.

- NS706** - nastro con testo "ATTENZIONE TUBAZIONI ACQUA"
- NS707** - nastro con testo "ATTENZIONE CAVI ELETTRICI"
- NS708** - nastro con testo "ATTENZIONE CAVO TELEFONICO"
- NS709** - nastro con testo "ATTENZIONE TUBO GAS"
- NS711** - nastro con testo "ATTENZIONE TUBO FOGNATURE"
- NS712** - nastro con testo "CAVI ELETTRICI ENEL"

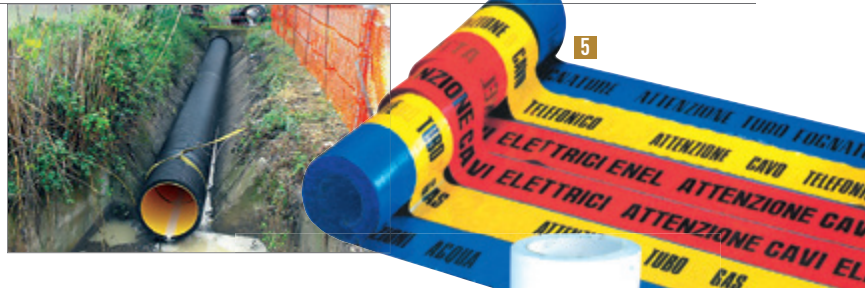

6 NASTRI RIFRANGENTI AUTOADESIVI

In rotoli di diverse altezze. Utili per segnalare, in condizioni di scarsa illuminazione, attrezzature, spigoli, scaffalature, sporgenze, ecc. Lunghezza rotoli: m 11,2 circa.

- R325.** - nastro h 25 mm. Colori: **W** bianco **R** rosso **Y** giallo **A** arancio **B** blu **G** verde
- R350.** - nastro h 50 mm. Colori: **W** bianco **R** rosso **Y** giallo **A** arancio **B** blu **G** verde
- R375.** - nastro h 75 mm. Colori: **W** bianco **R** rosso **Y** giallo
- R315.** - nastro h 150 mm. Colori: **W** bianco **R** rosso **Y** giallo
- R320.** - nastro h 200 mm. Colori: **W** bianco **R** rosso **Y** giallo





SROTOLAMENTO SILENZIOSO

1 NASTRO DA IMBALLO IN POLIPROPILENE A SROTOLAMENTO SILENZIOSO

Nastro adesivo in polipropilene a svolgimento silenzioso, da utilizzare con dispenser. Elevata resistenza e capacità adesiva. Adesivo: acrilico. Spessore 50 micron. Minimo ordinabile 36 rotoli/multipli. Colori: **W** bianco **H** avana **T** trasparente

NS50. - nastro da imballo in polipropilene a svolgimento silenzioso (specificare lettera colore), h mm 50 x m 66



SROTOLAMENTO RUMOROSO

2 NASTRO DA IMBALLO IN POLIPROPILENE A SROTOLAMENTO RUMOROSO

Nastro adesivo in polipropilene a svolgimento rumoroso, da utilizzare con dispenser. Adesivo: acrilico. Spessore 40 micron. Minimo ordinabile 36 rotoli/multipli. Colori: **H** avana **T** trasparente

NS48. - nastro da imballo in polipropilene a srotolamento rumoroso (specificare lettera colore), h mm 48 x m 66

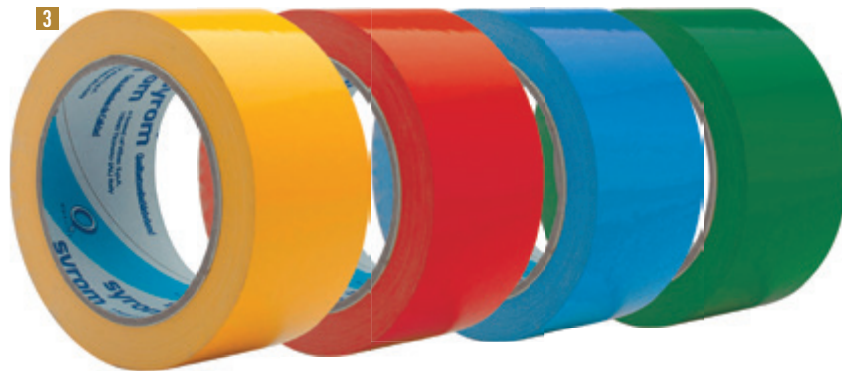

3 NASTRO ADESIVO COLORATO PER IMBALLI

Nastro adesivo colorato in polipropilene a svolgimento rumoroso da utilizzare con dispenser. Adesivo: gomma naturale. Spessore 45 micron. Minimo ordinabile 36 rotoli/multipli (dello stesso colore). Colori: **R** rosso **Y** giallo **B** azzurro **G** verde

NS238. - nastro adesivo colorato per imballi (specificare lettera colore) a svolgimento rumoroso, h mm 50 x m 66



4 NASTRO "AMERICAN TAPE"

Nastro in tela plastificata per riparazioni immediate e di uso universale. Resistente agli agenti atmosferici. Ottima conformabilità. Si taglia facilmente con le mani. Supporto: tela politenata. Minimo ordinabile 24 rotoli/multipli.

NS25 - nastro colore grigio in tela plastificata, h mm 50 x m 25



NASTRI STAMPATI IN POLIPROPILENE

Nastro adesivo in polipropilene a svolgimento silenzioso, da utilizzare con dispenser. Stampato con diciture standard "Fragile" e "Sigillo di garanzia". Elevata resistenza e capacità adesiva. Spessore 50 micron. Minimo ordinabile 36 rotoli/multipli. Nastro colore bianco con stampa colore rosso.

5 NS66F - nastro a svolgimento silenzioso con dicitura "Fragile", h mm 50 x m 66

6 NS66S - nastro a svolgimento silenzioso con dicitura "Sigillo di garanzia", h mm 50 x m 66



ETICHETTE PER IL TRASPORTO VARIE TIPOLOGIE ALLE PAGINE 332 E 333.



CONTATTACI PER UN PREVENTIVO.



7 NASTRI PERSONALIZZABILI

Nastri lunghezza 66 m, in polipropilene o PVC a svolgimento silenzioso, **personalizzabili con il logo del cliente**. Numero colori stampa: da 1 a 4. Altezze fornibili nei colori bianco, avana e trasparente: mm 9, 12, 15, 19, 25, 30, 38, 50 e 75. Altezze fornibili nei colori azzurro, giallo, rosso e verde: mm 12, 25, 50 e 75.

NSP.. - nastro a svolgimento silenzioso personalizzabile (ordine minimo per la personalizzazione: 144 rotoli)



1 NASTRO DI SICUREZZA "TAMPER EVIDENT"

Nastro anti-effrazione in poliestere siliconato rosso, spessore 23 my. Lascia un messaggio multilingue sul supporto in caso di tentata rimozione. Il messaggio di avvenuta apertura rimane ben visibile anche qualora si tentasse di richiudere il pacco. Si applica a mano o con dispenser come un comune nastro da imballo.

SGT50 - rotolo altezza mm 50, lunghezza m 50

2 DISPENSER STANDARD

Corpo in metallo e plastica, freno regolabile. Per rotoli di larghezza 50 mm.

NS250D - dispenser standard



FILM ESTENSIBILE

Trasparente in polietilene per applicazione su unità pallettizzate e per la protezione degli imballi da urti e sporcizia. Spessore 23 micron. Utilizzabili a mano o con l'apposito dispenser in plastica per film manuali con anima in cartone Ø 50 mm.

3 FITD - distributore in plastica per film estensibile FIT200, composto da **(A)**: maniglia porta bobina inferiore e superiore con manico in gomma frizionabile

4 FIT200 - confezione da 6 bobine di film estensibile, altezza mm 500 x lunghezza 200 m circa, peso a bobina 2,5 kg

5 FIT3150 - confezione da 30 minirotoli di film estensibile, altezza mm 100 x lunghezza 150 m, compreso di distributore in plastica con manico in gomma frizionabile (professionale)

6 BOLLINI COLORATI IN ROTOLO

Bollini in carta colorata con retro adesivo rimovibile. Ideali per tutte le attività ove è necessaria una codifica mediante colore (inventari, gestione dei materiali, ecc). Fornite in rotoli da 500 etichette. Diametro: 20, 35, 50 e 75 mm. A richiesta fornibili anche bollini con numeri **(B)**, mese **(C)** o anno **(D)**.

Colori: **W** bianco **R** rosso **Y** giallo **A** arancio
B blu **C** celeste **G** verde

NEB20 - bollini, rotolo da 500 etichette Ø mm 20

NEB35 - bollini, rotolo da 500 etichette Ø mm 35

NEB50 - bollini, rotolo da 500 etichette Ø mm 50

NEB75 - bollini, rotolo da 500 etichette Ø mm 75

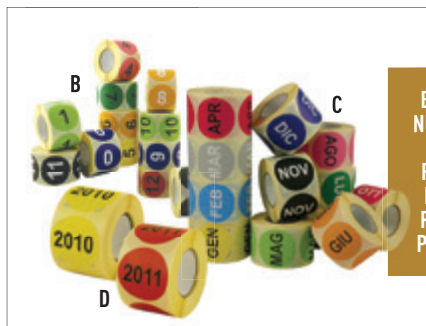

BOLLINI CON NUMERI, MESI O ANNI FORNIBILI A RICHIESTA. RICHIEDI UN PREVENTIVO.



ECAP 1807X

ALTRI SIMBOLI
E/O TESTI FORNIBILI
A RICHIESTA.

1 CARTELLI BIFACCIALI A LIBRO

Cartelli bifacciali in PVC espanso 3 mm. Da utilizzare appoggiati a terra per segnalare situazioni di pericolo. Facilmente trasportabili tramite apposita maniglia. A richiesta fornibili con altri segnali di sicurezza. Peso g 600.

ECAP....X - cartello bifacciale a libro, dimensioni mm 333 x 500 (chiuso)



ECAP 18043X



ECAP 1759X



ECAP 17147X



ECAP 1762X



ECAP 17127X



ECAP 1760X



ECAP 1779X



ECAP 17125X



ECAP 1761X



ECAP 351X



ECAP 18044X



ECAP 19161X



SEGNALI DI AVVISO

Robusti segnali in polipropilene di colore giallo, ideali sia per interni che per esterni.

2 CNP061 - segnale mm 270 x h mm 610, fornito con cartello in PVC 200 x 200 mm "Attenzione pavimento bagnato"

3 CNP610 - segnale bifacciale "Attenzione pavimento bagnato" (LATO A) "Fuori servizio" (LATO B), mm 270 x 610 h, peso kg 0,7



CARTELLI SCRIVIBILI E CANCELLABILI

4 ECAP170NX - cartello neutro bifacciale a libro in PVC espanso 3 mm, dimensioni mm 333 x 500 (chiuso)

5 SMAT36 - confezione da 4 pennarelli cancellabili (colori verde, rosso, nero e blu)



SEGNALI DI AVVISO

Colore giallo, ideali per interni ed esterni.

6 CNP8634 - segnale conico in polipropilene, h mm 930, peso kg 1,5, da abbinare alle tabelle CNP24. Foro per aggancio catene (acquistabili a parte - vedi pag. 296)

7 CNP241 - tabella "Pavimento bagnato", dimensioni mm 360 x 300

8 CNP242 - tabella "Attenzione pulizia in corso", dimensioni mm 360 x 300

9 CNP243 - tabella "Fuori servizio", dimensioni mm 360 x 300

ALTRE GRAFICHE FORNIBILI A RICHIESTA. RICHIEDI UN PREVENTIVO.



ETICHETTE MAGNETICHE

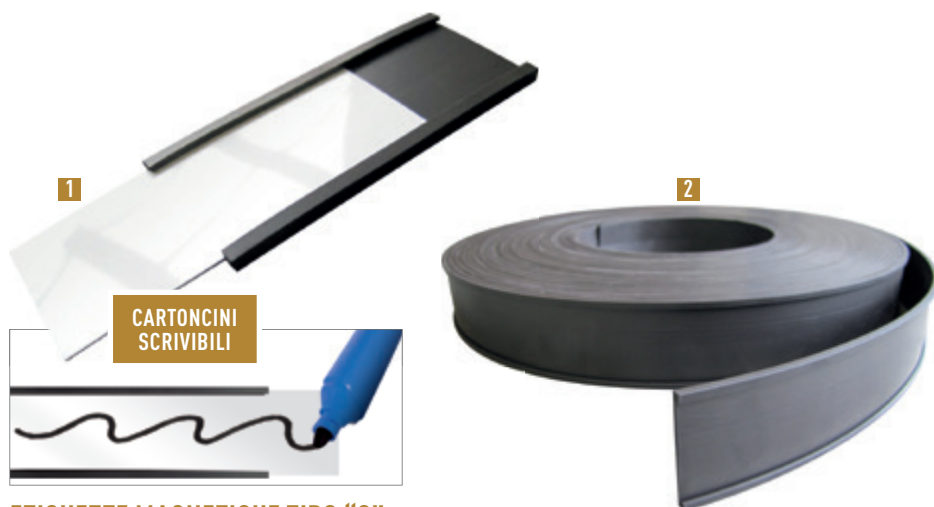

CARTONCINI SCRIVIBILI

ETICHETTE MAGNETICHE TIPO "C"

Pratiche etichette magnetiche tipo "C", realizzati in gomma magnetica. Sono un modo semplice per identificare i codici di magazzino su scaffalature, cassetti e contenitori metallici senza rovinare il supporto. Rimovibili, possono essere sostituiti e spostati con enormi risparmi di tempo. Fornite con PVC trasparente antipolvere e cartoncino bianco. Disponibili in 2 lunghezze e 3 altezze. Confezioni pretagliate da 10 pezzi.

- 1 SCS3007W** - 10 etichette pretagliate + 10 cartoncini, dimensioni 75 x 30 mm
- SCS4007W** - 10 etichette pretagliate + 10 cartoncini, dimensioni 75 x 40 mm
- SCS5007W** - 10 etichette pretagliate + 10 cartoncini, dimensioni 75 x 50 mm
- SCS3015W** - 10 etichette pretagliate + 10 cartoncini, dimensioni 150 x 30 mm
- SCS4015W** - 10 etichette pretagliate + 10 cartoncini, dimensioni 150 x 40 mm
- SCS5015W** - 10 etichette pretagliate + 10 cartoncini, dimensioni 150 x 50 mm
- 2 SCM36** - nastro magnetico h 30 mm completo di cartoncino bianco e PVC trasparente, in rotolo da 6 metri
- SCM46** - nastro magnetico h 40 mm completo di cartoncino bianco e PVC trasparente, in rotolo da 6 metri
- SCM56** - nastro magnetico h 50 mm completo di cartoncino bianco e PVC trasparente, in rotolo da 6 metri
- SCMC.** - cartoncino scrivibile per nastri magnetici m 1 (altezze fornibili mm 27, 37 e 47)



3 ETICHETTE MAGNETICHE LISCE NEUTRE

Gomma magnetica liscia spessore 1,2 mm. Convenienti per applicare, rimuovere e sostituire codici a barre e descrizione dei prodotti a scaffale. Ideali per l'applicazione di etichette adesive. Fornibili a richiesta anche rotoli lunghezza 50 metri. Disponibili in 2 lunghezze e 3 altezze. Confezioni pretagliate da 10 pezzi.

- SCL3007W** - 10 etichette neutre, dimensioni 75 x 30 mm
- SCL4007W** - 10 etichette neutre, dimensioni 75 x 40 mm
- SCL5007W** - 10 etichette neutre, dimensioni 75 x 50 mm
- SCL3015W** - 10 etichette neutre, dimensioni 150 x 30 mm
- SCL4015W** - 10 etichette neutre, dimensioni 150 x 40 mm
- SCL5015W** - 10 etichette neutre, dimensioni 150 x 50 mm

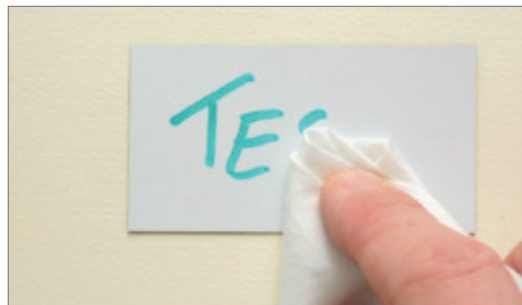

4 ETICHETTE MAGNETICHE SCRIVIBILI BIANCHE

Nastro magnetico liscio spessore 0,6 mm rivestito con uno strato di PVC bianco scrivibile e cancellabile a secco. Scrivibile con pennarelli per lavagne magnetiche e cancellabile a secco oppure con altri pennarelli, in questo caso cancellabile con alcol. Disponibili in 2 lunghezze e 3 altezze. Confezioni pretagliate da 10 pezzi.

- SCR3007W** - 10 etichette bianche, dimensioni 75 x 30 mm
- SCR4007W** - 10 etichette bianche, dimensioni 75 x 40 mm
- SCR5007W** - 10 etichette bianche, dimensioni 75 x 50 mm
- SCR3015W** - 10 etichette bianche, dimensioni 150 x 30 mm
- SCR4015W** - 10 etichette bianche, dimensioni 150 x 40 mm
- SCR5015W** - 10 etichette bianche, dimensioni 150 x 50 mm

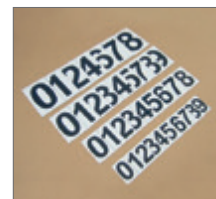
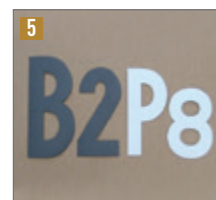

5 KIT DI LETTERE E NUMERI MAGNETICI

Utilizzati per codificare le corsie delle scaffalature metalliche. Fustellati e venduti singolarmente, disponibili nelle misure 80, 100 e 120 mm. Colori: bianco o nero. Fornibili a richiesta (richiedi un preventivo).



SEGNALETICA DI SICUREZZA BIFACCIALE FOLD A PAGINA 81.

1 SUPPORTO BIFACCIALE NEUTRO FOLD + ETICHETTE APPLICATE

Supporto bifacciale flessibile neutro in PVC 0,5 mm. Utilizzabile con etichette autoadesive (vedi tabelle).

SFL200 - solo supporto bifacciale flessibile 145 x 200 mm, utilizzabile con lettere e numeri singoli autoadesivi codici 905.. - 915.. - 925 (vedi tabella)

SFL250 - solo supporto bifacciale flessibile 175 x 250 mm, utilizzabile con lettere e numeri singoli autoadesivi codici 906.. - 916.. (vedi tabella)

TABELLA LETTERE E NUMERI SINGOLI AUTOADESIVI PER SFL200

CODICE ARTICOLO			NUMERO D'IDENTIFICAZIONE				FORMATI (mm)			Confezione da 1 foglio. 10 etichette per foglio.
Giallo nero	Bianco rosso	Blu bianco	Numeri consecutivi	Lettere consecutive	Numeri individuali	Lettere individuali	Etichette (b x h)	Foglio (b x h)	Carattere (h)	
905	915	925	..09	..AJ ..KT ..UZ	..1 ..2 ..3	..A ..B ..C	56 x 99	280 x 200	83	

i KIT LETTERE E NUMERI IN ALTRI COLORI FORNIBILI A RICHIESTA. CODICE SXDSFL200.. (10 ETICHETTE PER FOGLIO PER SUPPORTO SFL200).

TABELLA LETTERE E NUMERI SINGOLI AUTOADESIVI PER SFL250

CODICE ARTICOLO			NUMERO D'IDENTIFICAZIONE				FORMATI (mm)			Confezione da 1 foglio. 10 etichette per foglio.
Giallo nero	Bianco rosso	Blu bianco	Numeri consecutivi	Lettere consecutive	Numeri individuali	Lettere individuali	Etichette (b x h)	Foglio (b x h)	Carattere (h)	
906	916	-	..09	..AJ ..KT ..UZ	..1 ..2 ..3	..A ..B ..C	70 x 124	350 x 250	103	

i KIT LETTERE E NUMERI IN ALTRI COLORI FORNIBILI A RICHIESTA. CODICE SXDSFL250.. (10 ETICHETTE PER FOGLIO PER SUPPORTO SFL250).

i LA SEGNALETICA FLESSIBILE IN PVC, A DIFFERENZA DELL'ALLUMINIO, EVITA DANNI AL CARTELLO IN CASO DI URTI ACCIDENTALI DURANTE LA MOVIMENTAZIONE DELLE MERCI.

2 SUPPORTO BIFACCIALE NEUTRO FOLD + STAMPA DIGITALE APPLICATA

Supporto bifacciale flessibile neutro in PVC 0,5 mm. Stampa digitale applicata fronte/retro compresa nella fornitura.

SXDSFLP200.. - supporto bifacciale flessibile 145 x 200 mm + stampa digitale applicata fronte/retro

SXDSFLP250.. - supporto bifacciale flessibile 175 x 250 mm + stampa digitale applicata fronte/retro





NUMERI E LETTERE AUTOADESIVE PER IDENTIFICAZIONE

Numeri e lettere singoli

Numeri e lettere in PVC adesivo, ideali per contrassegnare ed identificare scaffalature, uscite, estintori e quadri elettrici.

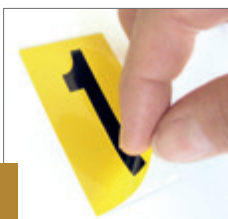

DISPONIBILI IN 8 DIVERSI FORMATI E 4 COLORAZIONI AD ALTA VISIBILITÀ!

8
6x10

R
10x15

3
16x24

4
24x34

A
34x60

M
56x99

7
70x124

2
99x175

TABELLA LETTERE E NUMERI SINGOLI AUTOADESIVI

CODICE ARTICOLO				NUMERO D'IDENTIFICAZIONE				FORMATI (mm)			CONFEZIONE E NUMERO DI FOGLI
Giallo nero	Bianco nero	Bianco rosso	Blu bianco	Numeri consecutivi	Lettere consecutive	Numeri individuali	Lettere individuali	Etichette (b x h)	Foglio (b x h)	h carattere	
900	930	910	920	..09	..AZ	..1 ..2 ..3 ecc.	..A ..B ..C ecc.	6 x 10	120 x 30	6	Confezione da 5 fogli. 60 etichette per foglio.
901	931	911	-	..09	..AZ	..1 ..2 ..3 ecc.	..A ..B ..C ecc.	10 x 15	200 x 45	11	
902	932	912	922	..09	..AZ	..1 ..2 ..3 ecc.	..A ..B ..C ecc.	16 x 24	160 x 72	17	Confezione da 5 fogli. 30 etichette per foglio.
903	933	913	923 *	..09	..AZ	..1 ..2 ..3 ecc.	..A ..B ..C ecc.	24 x 34	240 x 102	24	
904	934	914	924	..09	..AJ ..KT ..UZ	..1 ..2 ..3 ecc.	..A ..B ..C ecc.	34 x 60	340 x 60	50	Confezione da 5 fogli. 10 etichette per foglio.
905	935	915	925	..09	..AJ ..KT ..UZ	..1 ..2 ..3 ecc.	..A ..B ..C ecc.	56 x 99	280 x 200	83	Confezione da 1 foglio. 10 etichette per foglio.
906	936	916	-	..09	..AJ ..KT ..UZ	..1 ..2 ..3 ecc.	..A ..B ..C ecc.	70 x 124	350 x 250	103	
907	937	917	-	-	-	..1 ..2 ..3 ecc.	..A ..B ..C ecc.	99 x 175	99 x 175	134	Confezione da 1 foglio. 1 etichetta per foglio.

* A richiesta fogli individuali (lettere e numeri)

CODICE 912.3
CIFRE UGUALI,
16 X 24 MM



CODICE 901.3
CIFRE UGUALI,
10 X 15 MM



CODICE 920.09
CIFRE DA 0 A 9,
6 X 10 MM



CODICE 905.AJ
LETTERE A-J,
56 X 99 MM



CODICE 934.KT
LETTERE K-T,
34 X 60 MM





SEQUENZE DI CIFRE CONSECUTIVE NERE SU FONDO GIALLO

Pratiche sequenze di numeri in confezione da 100 o 500 etichette. Consentono di risparmiare tempo e denaro in caso di numerazioni in sequenza.



TABELLA CIFRE NERE SU FONDO GIALLO (mm)

CODICE ARTICOLO	NUMERAZIONE CONSECUTIVA DA N° A N°	ETICHETTE PER FOGLIO	FOGLI PER CONFEZIONE	ETICHETTE PER CONFEZIONE	ETICHETTE (b x h)	FOGLIO (b x h)	CARATTERE (altezza)
908.25	da 001 a 500	10	50	500	42 x 24	97 x 156	17
908.29	da 501 a 999	10	10	100	44 x 34	98 x 200	24



CIFRE CONSECUTIVE DA 01 A 99

908.31

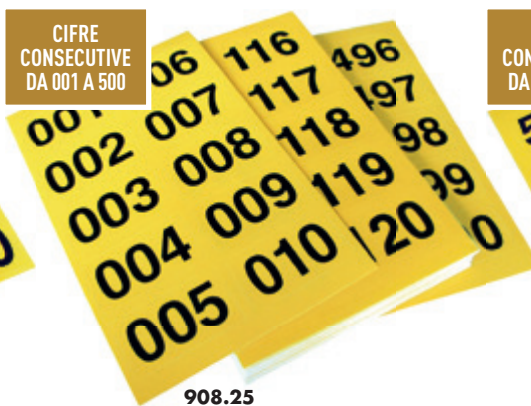

CIFRE CONSECUTIVE DA 001 A 500

908.25



CIFRE CONSECUTIVE DA 501 A 999

908.29

NUMERI E LETTERE PER CONTRASSEGNARE CAPANNONI, SCAFFALATURE, USCITE, REPARTI ECC...

LE PRIME DUE CIFRE DEL CODICE IDENTIFICANO IL FORMATO

CODICE	COLORE	FORMATO (mm)	MATERIALE	DISTANZA DI LETTURA
86...	Fondo blu - testo bianco	250 x 400	Alluminio spessore 0,7	m 20 ÷ 25
89...	Fondo blu - testo bianco	333 x 600	Alluminio spessore 0,7	m 40 ÷ 50
86...BN	Fondo bianco - testo nero	250 x 400	Alluminio spessore 0,7	m 20 ÷ 25
89...BN	Fondo bianco - testo nero	333 x 600	Alluminio spessore 0,7	m 40 ÷ 50

1	2	3	4	5	6	7	8	9
8651 8901	8652 8902	8653 8903	8654 8904	8655 8905	8656 8906	8657 8907	8658 8908	8656 8906
0	A	B	C	D	E	F	G	H
8650 8900	8661 8911	8662 8912	8663 8913	8664 8914	8665 8915	8666 8916	8667 8917	8668 8918
I	J	K	L	M	N	P	Q	R
8669 8919	8681 8931	8682 8932	8670 8920	8671 8921	8672 8922	8673 8923	8674 8924	8675 8925
S	T	U	V	W	X	Y	Z	
8676 8926	8677 8927	8678 8928	8679 8929	8683 8933	8684 8934	8685 8935	8680 8930	





1

1 VERNICE TRACCIALINEE SAFE IN®

Ideale per aree di stoccaggio, magazzini, parcheggi, aree produttive, piste ciclabili, campi sportivi, ecc. Per delimitare le superfici e ottimizzare la circolazione in interno o esterno. Permette di tracciare linee da 5 a 10 cm di larghezza. Resistente all'usura e alle intemperie, eccellente aderenza a tutte le superfici. Asciugatura rapida: 15-20 minuti. Linee nette. Temperatura di utilizzo da +50°C a -50°C. La bombola contiene ml 500 di vernice e consente di tracciare circa 50 m lineari di striscia. Fornita con due diversi ugelli. Confezioni da 12 bombole per cartone. Minimo ordinabile 12 bombole/multipli.

Colori: **W** bianco **N** nero **R** rosso **Y** giallo **B** blu **G** verde

NS1011S - bombola da 500 ml di vernice Safe In®

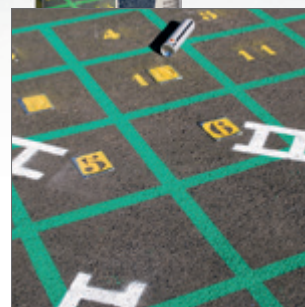

CONDIZIONI GENERALI DI IMPIEGO

Le seguenti raccomandazioni devono essere rispettate per una buona applicazione della vernice Safe In®, indipendentemente dal tipo di terreno. Pulire bene per eliminare polvere, sporco, grasso... Il tasso igrometrico deve essere compreso tra il 10 ed il 50%. La temperatura di applicazione non deve essere inferiore a 5°C. Per una buona qualità di tracciatura si consiglia di effettuare il primo passaggio velocemente, i passaggi successivi più lentamente fino a raggiungere la copertura desiderata. Raccomandazioni a seconda del tipo di terreno:

- Calcestruzzo nuovo: attendere da 3 a 4 settimane per l'asciugatura del calcestruzzo e l'eliminazione dell'acidità prima di applicare la vernice.
- Asfalto nuovo: è consigliato attendere almeno 15 giorni prima dell'applicazione.
- Pavimentazioni sintetiche (plastica, PVC) e pavimentazioni verniciate (vernice epossidica, poliuretana), è consigliabile fare un test preventivo per verificare l'aderenza della vernice alla pavimentazione.

Prima dell'utilizzo agitare a lungo l'aerosol a testa in giù.



2

2 CARRELLO TRACCIALINEE

Carrello traccialinee specificamente concepito per la gamma di vernici Safe In®. Maneggevole, preciso, stabile, si adatta a molteplici superfici ed applicazioni. Permette di tracciare linee diritte e curve. Impugnatura adattabile destra o sinistra. Tracciatura simultanea possibile con 2 spray contemporaneamente.

NS1001KS - carrello traccialinee Safe In®





1



1 VERNICE TRACCIALINEE FLUORESCENTE DA CANTIERE SAFE IN®

Ideale per marcare su terra, sterrato, tubature, costruzioni, installazioni elettriche. Essiccazione rapida. Buona durata alle intemperie. Cappuccio girevole che impedisce la vaporizzazione accidentale. Non cola durante l'utilizzo grazie al contenitore di sicurezza brevettato. Applicazione manuale o tramite i nostri accessori (asta e pistola di marcaggio). Ampia gamma di colori per tutte le esigenze di marcatura. Minimo ordinabile 1 bombole/multipli.

Colori: **W** bianco **A** arancio fluo **R** rosso fluo **Y** giallo fluo **B** blu fluo **G** verde fluo **P** rosa fluo

NS400S - bombola da 500 ml di vernice fluo da cantiere Safe In®



STOCCAGGIO E MANUTENZIONE: CONSERVARE LE BOMBOLETTE TRA I 15 E I 25°C E TRA IL 50 E 60% DI UMIDITÀ RELATIVA. NON ESPORRE A UNA TEMPERATURA SUPERIORE A 50°C. TENERE LONTANO DA TUTTE LE FONTI DI CALORE.

CARATTERISTICHE

- Utilizzabile su diverse superfici: calcestruzzi, bitumi, erba, ghiaie, sabbie, minerali, legno, asciugatura rapida (circa 10 min.)
- Contenitore di sicurezza molto resistente.
- Buona autonomia e copertura: 1 bomboletta è sufficiente per coprire (permanentemente) una linea di 55 m (larghezza 2 cm) con il carrello traccialinee.
- Buona durata della marcatura anche su superfici bagnate: fino a 6 mesi in base alla superficie, le condizioni di applicazioni e l'esposizione ai raggi UV.
- Temperature d'utilizzo: da -20°C a +50°C.
- Composizione: acrilico - pigmenti: minerali e organici. Senza piombo e cadmio
- Solventi: miscela complessa esente da solvente clorurati e da composti aromatici (toluene, xilene ...).
- Gas propellente: miscela specifica di isobutano e propano.



RACCOMANDATA
CON VERNICI
TRACCIALINEE DA
CANTIERE SAFE IN®.

2

2 ASTA DI MARCAGGIO SAFE IN®

Asta traccialinee leggera ed ergonomica, grazie alla scelta dei materiali che la compongono e a un design studiato per il comfort dell'utilizzatore. Flessibile e indispensabile, si adatta a tutte le bombolette Safe In®.

NS401KS - asta porta traccialinee Safe In®



RACCOMANDATA
CON VERNICI
TRACCIALINEE DA
CANTIERE SAFE IN®.

3

3 PISTOLA DI MARCAGGIO SAFE IN®

Leggera e professionale, consente la tracciatura anche su superfici irregolari. Indispensabile per la marcatura con le dime.

NS405KS - pistola di marcaggio Safe In®



DIME IN CARTONE AD ALTA DENSITÀ

Dime in cartone mm 800 x 800



NC800



NC801



NC802



NC803



NC804



NC805



NC806



NC807



NC808



NC809



NC810



NC811



NC812



NC813



NC814



NC815



NC816



NC817



NC818



NC819



NC820



NC821



Dime in cartone mm 800 x 400



NC403



NC404



NC405



NC406



NC407

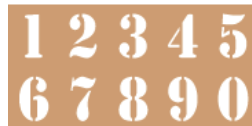

NC408



NC409



NC410



NC411



NC401



NC402

Dime in cartone mm 800 x 250



NC251



NC252

ALTRI SIMBOLI E SCRITTE FORNIBILI A RICHIESTA (RICHIEDERE PREVENTIVO).

Dime in cartone mm 1150 x 250

Fornite in due pezzi distinti.



NC1151



NC1152



NC1153



NC1154



NC1155



NC1156



NC1157



DIME IN CARTONE E IN ALLUMINIO SPECIALI

PERSONALIZZABILI

Le dime sono uno strumento necessaria per tracciare diciture e prescrizioni, sia su asfalto che su imballaggi. Rispetto alle tradizionali dime in cartone, le dime in alluminio consentono la realizzazione di simboli estremamente precisi, sono molto più resistenti e durature e possono essere riutilizzate all'infinito. In fase di applicazione del pittogramma o della scritta, si consigliano le apposite vernici traccialinee Safe In® alle pagine 210 e 211. Possiamo fornirti dime in qualsiasi formato e con le immagini/testi che vuoi! Se non trovi ciò che cerchi in queste pagine, richiedi un preventivo!

RALENTARE
RICARICA
MULETTI



RICHIEDI UN PREVENTIVO!

Dime in alluminio mm 800 x 800

NC8...A - dime in alluminio 20/10

ALTRE TIPOLOGIE DISPONIBILI.



NC802 A



NC803 A



NC805 A



NC806 A



NC807 A



NC811 A



NC801 A

Dime in alluminio mm 1150 x 250

NC11..A - dime in alluminio 20/10, fornita in due pezzi distinti



NC1152 A



NC1153 A



NC1154 A

Dime in alluminio mm 800 x 400

NC4...A - dime in alluminio 20/10



NC401 A



NC402 A

ALTRE TIPOLOGIE DISPONIBILI.

Dime varie in alluminio 30/10

In base alle dimensioni, le dime in alluminio vengono fornite in pezzo singolo o più pezzi componibili per agevolare il trasporto.



NC310 A
alluminio 30/10,
840 x 1170 mm



NC311 A
alluminio 30/10,
832 x 890 mm



NC312 A
alluminio 30/10,
880 x 800 mm



NC313 A
alluminio 30/10,
1000 x 800 mm

ALTRE TIPOLOGIE DISPONIBILI.

Stencil in alluminio per imballaggi

Stencil di marcatura in alluminio 10/10. Angolo di appoggio 20 mm per agevolare il posizionamento e l'impugnatura. Ideali per contrassegnare casse, scatole e qualsiasi altro tipo di contenitore necessari di numerazioni o scritte. Disponibili set di numeri, lettere e simboli formato A5 (210 x 148 mm). Altezza indicativa numeri 144 mm, altezza indicativa lettere 137 mm.



NC700 A
Kit numeri 0-9

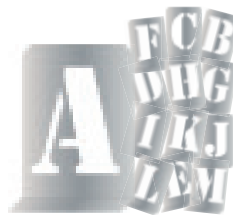

NC701 A
Kit lettere A-M (alfabeto inglese)



NC702 A
Kit lettere N-Z (alfabeto inglese)



9464 AA
Teme l'umidità



9465 AA
Alto



9466 AA
Da maneggiare con precauzione



9467 AA
Non utilizzare ganci



9468 AA
Teme il calore

A RICHIESTA, FORNIBILE DIME CON QUALSIASI SIMBOLI E TESTO (RICHIEDI UN PREVENTIVO).



SEGNALI, SCRITTE E BOLLI AUTOADESIVI DA PAVIMENTO

Pittogrammi da pavimento autoadesivi

Pittogrammi ISO 7010, scritte e bolli da pavimento per uso interno, realizzati in PVC spessore 95 micron accoppiato con film protettivo antiscivolo di spessore non inferiore a 125 micron. Resistenti all'abrasione e al traffico pedonale. Temperatura di applicazione: da +5°C a +50°C. Temperatura di servizio: da -20°C a +60°C.



PP1301
Ø 435 mm



PP1304
Ø 435 mm



PP1305
Ø 435 mm



PP1312
Ø 435 mm



PP1321
Ø 435 mm



PP1335
Ø 435 mm



PP1348
Ø 435 mm



PP1351
Ø 435 mm



PP1352
Ø 435 mm



PP1355
Ø 435 mm



PP1356
Ø 435 mm



PP1358
Ø 435 mm



PP1381
Ø 435 mm



PP1389
Ø 435 mm



PP1101
560 x 560 mm



PP1107
560 x 560 mm



PP1108
560 x 560 mm



PP1109
560 x 560 mm



PP1114
560 x 560 mm



PP1137
560 x 560 mm



PP15107 *
435 x 435 mm



PP15180 *
435 x 435 mm



PP715101 *
480 x 250 mm



PP715102 *
480 x 250 mm



PP037
435 x 435 mm



PP037D
175 x 305 mm



PP037S
175 x 305 mm



PP047
Ø 435 mm



PP080
Ø 435 mm

* Fornibili a richiesta in versione fotoluminescente aggiungendo la lettera "L" dopo PP... (esempio: PPL15107). Richiedere preventivo.

PER FAVORE
ATTENDI QUI
IL TUO TURNO

A RICHIESTA, FORNITI SU
SUPPORTO IN METALLO PER
PAVIMENTAZIONI IRREGOLARI.
RICHIEDI UN PREVENTIVO.



ALTRI
PITTOGRAMMI
FORNIBILI A
RICHIESTA.

Scritte da pavimento autoadesive

ATTENZIONE NON ENTRARE - SOLO PERSONALE AUTORIZZATO

PP150 - 1200 x 150 mm

SI PREGA DI ATTENDERE DIETRO LA LINEA

PP151 - 1200 x 150 mm

ATTENZIONE

PP152 - 400 x 150 mm

**ATTENZIONE
AL GRADINO**

PP153 - 400 x 150 mm



SCRITTE E BOLLI DA PAVIMENTO
FORNIBILI A RICHIESTA IN ALTRE
DIMENSIONI/COLORI.

Bolli da pavimento autoadesivi

Fondo giallo, scritta nera, Ø mm 300. In fase d'ordine specificare le lettere o i numeri desiderati.

ESEMPI DI CODIFICA



PP300YN.A
Ø 300 mm



PP300YN.B
Ø 300 mm



PP300YN.1
Ø 300 mm



Segnali da pavimento autoadesivi "a mezzaluna"

Fornibili in due versioni, dimensioni 700 x 350 mm:

PPS... - **qualità standard**: stampa serigrafica su PVC adesivo con sovrastampa di protezione antiscivolo, minimo ordinabile: 10 pezzi / multipli. Buona resistenza all'abrasione e al traffico pedonale

PP... - **qualità Premium**: stampa digitale su PVC adesivo spessore 95 micron, rivestimento con film protettivo antiscivolo spessore 125 micron. Minimo ordinabile: 1 pezzo (disponibilità immediata). Elevata resistenza all'abrasione e al traffico pedonale



PP705



PP707

PPS707



PP708

PPS708



PP709

PPS709



PP710

PPS710



PP711

PPS711



5

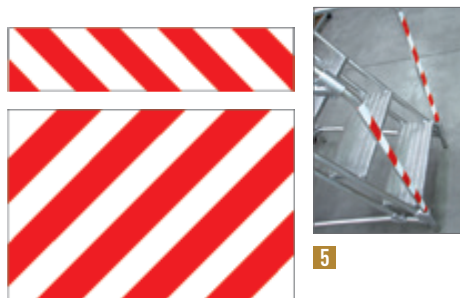

5

5 PANNELLI AUTOADESIVI

A strisce diagonali giallo/nero e bianco/rosso in esecuzione normale e rifrangente. Le strisce hanno due orientamenti che permettono di ottenere un segnale a spina di pesce, affiancando due pannelli.

DIMENSIONI DEI PANNELLI AUTOADESIVI

IMMAGINE/CODICE ARTICOLO				DIMENSIONI
				450 x 450 mm
9411	9411	9401	9401	450 x 300 mm
9417	9412	9407	9402	450 x 150 mm
9418	9413	9408	9403	450 x 100 mm
9419	9414	9409	9404	450 x 50 mm
9420	9415	9410	9405	

94...P = pellicola autoadesiva normale.

R94... = pellicola autoadesiva rifrangente.

6 PROFILI RIFRANGENTI

Su supporto di alluminio spessore mm 1, completo di 6 fori, pellicola rifrangente E.G. Riferimento normativo: D. Lgs. 81 del 09/04/08 Titolo V. Dimensioni: mm 1000 x 80.

CT15 - strisce bianco/rosso da destra a sinistra

CT05 - strisce bianco/rosso da sinistra a destra

CT04 - strisce giallo/nero da sinistra a destra

CT14 - strisce giallo/nero da destra a sinistra



6



AUTOADESIVI RETRORIFLETTENTI

Per la segnalazione di cassonetti stradali portarifiuti conformi art. 68 D.P.R. 495 del 16/12/92 (Reg. C.d.S.). Realizzati su due tipi di pellicola rifrangente (cl. 1/cl. 2 alta intensità), con speciale adesivo adatto all'applicazione sui diversi tipi di cassonetti (lamiera zincata, vetroresina, alluminio, polietilene).

7 NR33H - dimensioni: mm 400 x 100 - rifr. cl. 2

NR33E - dimensioni: mm 400 x 100 - rifr. cl. 1

8 NR34H - dimensioni: mm 400 x 100 - rifr. cl. 2

NR34E - dimensioni: mm 400 x 100 - rifr. cl. 1

9 NR35H - dimensioni: mm 400 x 200 - rifr. cl. 2

NR35E - dimensioni: mm 400 x 200 - rifr. cl. 1

10 NR36H - dimensioni: mm 200 x 200 - rifr. cl. 2

NR36E - dimensioni: mm 200 x 200 - rifr. cl. 1





Paracolpi in EVA espansa Safe In®

- Paracolpi realizzati in Eva espansa.
- Per interni ed esterni, ideali in magazzini, aree produttive e industriali in genere, scuole, ospedali, palestre.
- Utili come salvaspigoli nei passaggi, zone di transito, sia pedonali che con mezzi in movimento, ove gli spazi sono particolarmente ristretti e angusti (scale, sottoscale ecc).
- Flessibili, si applicano anche su superfici non lineari.
- Resistenti a vari tipi di oli, benzine, solventi e prodotti per le pulizie.
- Resistenti alle intemperie, ai raggi UV, alla salsedine e a temperature tra -15°C e +55°C.
- Forniti con o senza biadesivo in base ai modelli. In assenza di biadesivo possono essere utilizzate colle siliconiche e/o poliuretatiche.
- Tutti i dati dimensionali hanno una tolleranza del 3,5%.

EVA ESPANSA

È UN MATERIALE LEGGERO, ATOSSICO E ANALLERGICO, CON UNA FORTE STABILITÀ DIMENSIONALE. INATTACCABILE DA BATTERI E FUNGHI, È INOLTRE IMPERMEABILE, LAVABILE, RESISTENTE AI PRODOTTI CHIMICI E NON ASSORBE I CATTIVI ODORI.

VERSIONE CON SUPPORTO MAGNETICO!

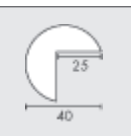

1

1 PGE425S - paracolpi lunghezza 780 mm x Ø 40 mm, peso 135 gr con biadesivo
PGE425SM - come sopra ma magnetico

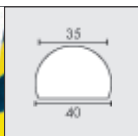

2

2 PGE430S - paracolpi lunghezza 780 mm x larghezza 35 mm, peso 135 gr con biadesivo
PGE430SM - come sopra ma magnetico

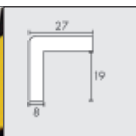
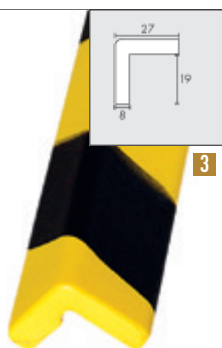

3

3 PGE320S - paracolpi lunghezza 780 mm x larghezza 27 mm, peso 135 gr con biadesivo
PGE320SM - come sopra ma magnetico

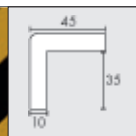

4

4 PGE322S - paracolpi lunghezza 780 mm x 45 mm, peso 135 gr con biadesivo, colore giallo/nero
PGE322SM - come sopra ma magnetico

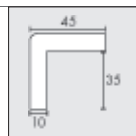
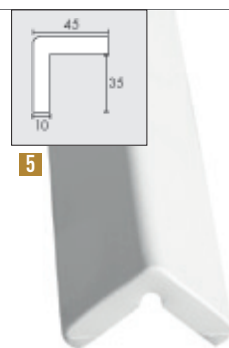

5

5 PGE320SW - paracolpi lunghezza 780 mm x 45 mm, peso 135 gr con biadesivo, colore bianco
PGE320SWM - come sopra ma magnetico

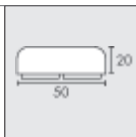
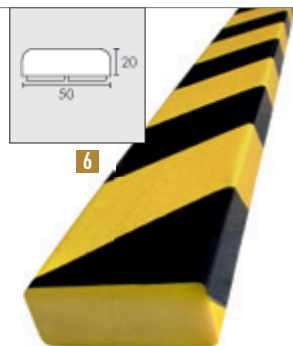

6

6 PGE520S - paracolpi lunghezza 780 mm x 50 x 20 h, peso 200 gr, con biadesivo
PGE520SM - come sopra ma magnetico

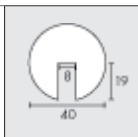
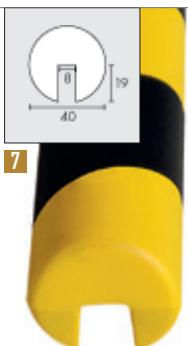

7

7 PGE420S - paracolpi lunghezza 780 mm x Ø 40 mm, peso 200 gr senza biadesivo

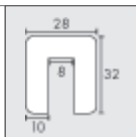

8

8 PGE230S - paracolpi lunghezza 780 mm x larghezza 28 mm, peso 135 gr senza biadesivo

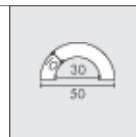
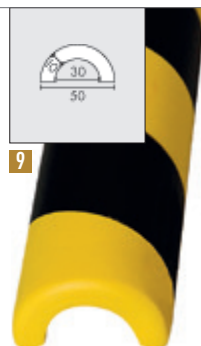

9

9 PGE435S - paracolpi lunghezza 780 mm x altezza 30 mm, peso 135 gr con biadesivo

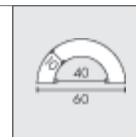

10

10 PGE735S - paracolpi lunghezza 780 mm x altezza 40 mm, peso 200 gr con biadesivo

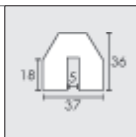

11

11 PGE121S - paracolpi lunghezza 780 mm x altezza 36 mm, peso 200 gr senza biadesivo

Paracolpi rigati

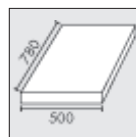
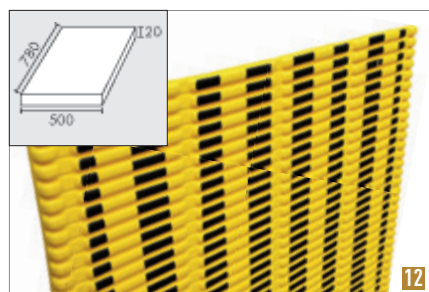

12

12 PGE902S - paracolpi piano rigato mm 780 x 570 x h 20 colore giallo/nero, spessore 20 mm, peso kg 1,9, senza biadesivo

13 PGE801S - paracolpi cavo rigato giallo/nero, senza biadesivo. Protegge colonne tonde e pali, utilizzabile come salva colonne in parcheggi e garage. Ø minimo 20 mm, Ø max 200 mm. Altezza 780 mm, spessore 20 mm, peso kg 1,2



13



Angolari

Prodotto in poliuretano colore nero, fornito completo di biadesivo, posizionabile su angoli. Utilizzabile in magazzini, ideali per scaffalature.

14 PGE402 - angolare a 2 vie

15 PGE403 - angolare a 3 vie



14



15

FORNIBILI A RICHIESTA LASTRE PIANE COLORE GIALLO/NERO, SPESSORE DA 20 A 35 MM, DIMENSIONE MASSIMA 100 X 200 CM.



Paracolpi in poliuretano

- Paracolpi riciclabili, realizzati in schiuma di poliuretano.
- Autoadesivi, ideali per superfici di metallo e legno, applicabili a muro.
- Posizionabili su angoli o superfici piane.
- Flessibili, si applicano anche su superfici non lineari.
- Per interni ed esterni, ideali ovunque si necessiti di protezione contro gli urti (magazzini, aree produttive e industriali in genere, scuole, ospedali, palestre).
- Resistono a temperature tra -40°C e +100°C.
- Tutti i dati dimensionali hanno una tolleranza del 3,5%.
- A richiesta è fornibile la versione con piastra di fissaggio.
- Fire classification: a norma DIN EN 13501-1 / classe E.

POLIURETANO

È UN MATERIALE CHE NON SI SFALDA, NON INVECCHIA E NON DECOLORA. RESISTE A QUALSIASI CONDIZIONE AMBIENTALE, QUINDI PUÒ ESSERE APPLICATO ANCHE IN AMBIENTI CON SALSDINE E UMIDITÀ. INERTE, NON MARCISCE ED È IMPERMEABILE.

FORNIBILE A RICHIESTA VERSIONE CON PIASTRA DI FISSAGGIO.

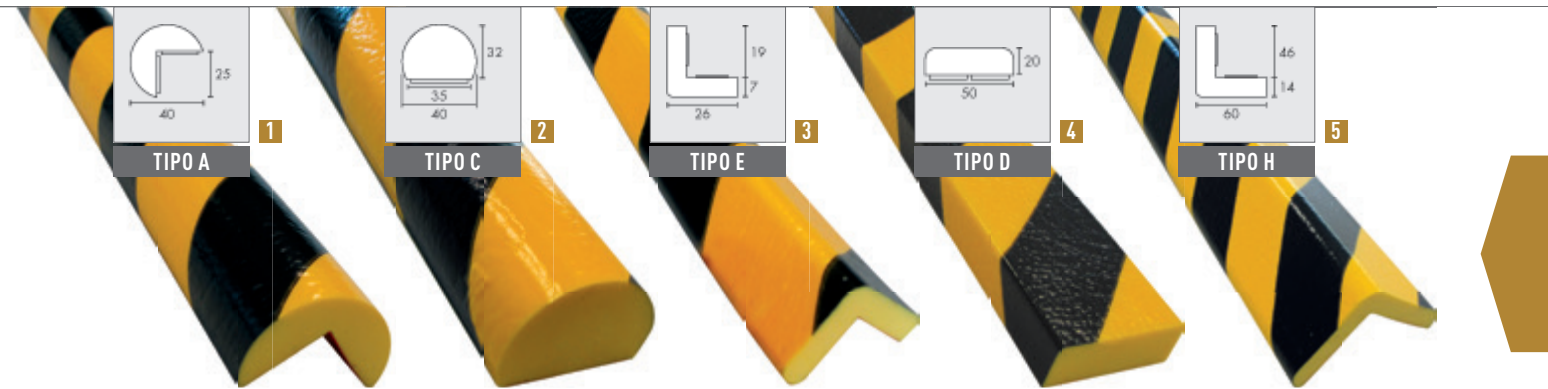

1 PGE425 - paracolpi tipo A per angoli, lunghezza 1 m, Ø 40 mm

2 PGE430 - paracolpi tipo C, lunghezza 1 m, larghezza 35 mm

3 PGE320 - paracolpi tipo E, lunghezza 1 m x 26
PGE320/5 - paracolpi tipo E in spezzone unico da 5 m

4 PGE520 - paracolpi tipo D, lunghezza 1 m, larghezza mm 50 x 20 h

5 PGE322 - paracolpi tipo H+, lunghezza 1 m, larghezza 60 mm

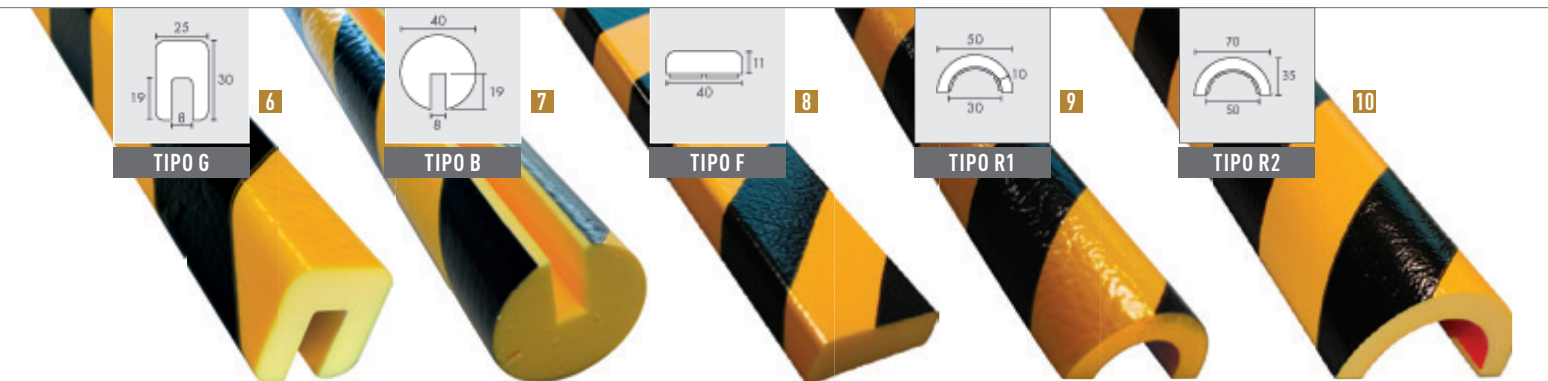

6 PGE230 - paracolpi tipo G, lunghezza 1 m, larghezza mm 30 x 25 h

7 PGE420 - paracolpi tipo B (senza biadesivo), lunghezza 1 m, Ø 40 mm

8 PGE410 - paracolpi tipo F piatto
PGE410/5 - paracolpi tipo F, in spezzone unico da 5 m

9 PGE435 - paracolpi tipo R1 per tubature

10 PGE735 - paracolpi tipo R2 per tubature

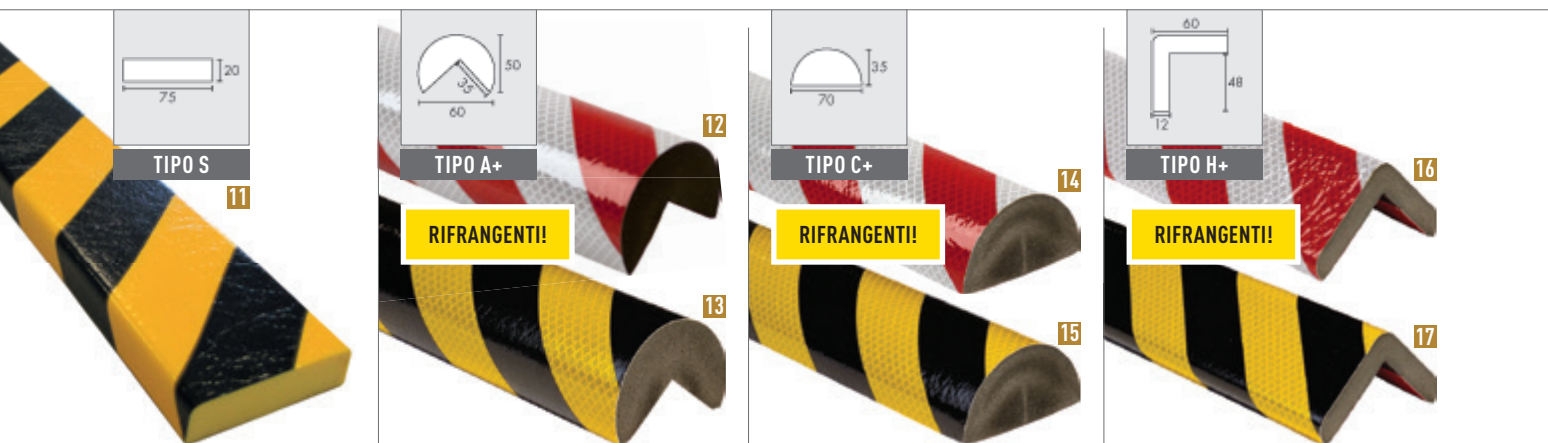

11 PGE399 - paracolpi tipo S, lunghezza 1 m, larghezza mm 75 x 20 h

12 PGE720RW - paracolpi rifrangente lunghezza 1 m Ø 60 mm

13 PGE720YN - paracolpi rifrangente lunghezza 1 m Ø 60 mm

14 PGE722RW - paracolpi rifrangente lunghezza 1 m x 70 mm

15 PGE722YN - paracolpi rifrangente lunghezza 1 m x 70 mm

16 PGE727YN - paracolpi rifrangente lunghezza 1 m x 60 mm

17 PGE727RW - paracolpi rifrangente lunghezza 1 m x 60 mm



PARACOLPI GRANDE FORMATO

Paracolpi grande formato

In gomma nitrile butadiene (**NBR**) o etilene vinil-acetato (**EVA**). Resistenti agli oli, grassi, derivati del petrolio e acidi. Di dimensioni maggiorate, estremamente visibili, di facile applicazione, forniti con biadesivo. Proteggono da urti e graffi.

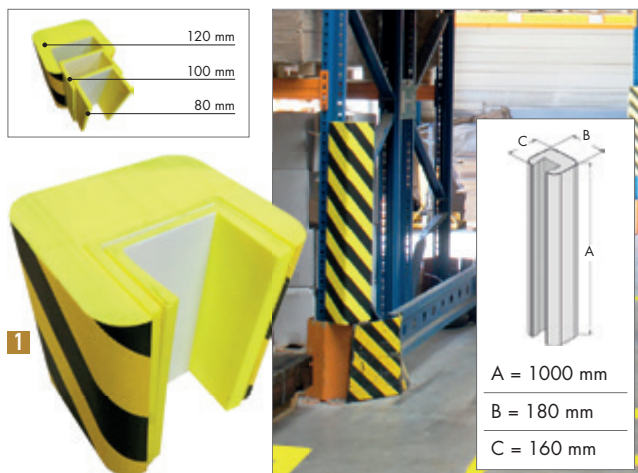

1 PARACOLPI PER SCAFFALATURE INDUSTRIALI

PGV400 - paracolpi in acetato (EVA), fornito con biadesivo, peso 1450 g

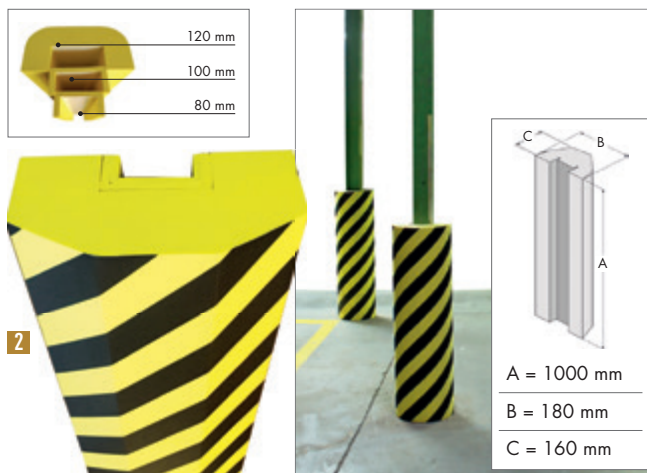

2 PARACOLPI PER COLONNE E SOSTEGNI INDUSTRIALI

PGV1001 - paracolpi in acetato (EVA), fornito con biadesivo, peso 1650 g



3 PARACOLPI ANGOLARE

PGV15025 - paracolpi in acetato (EVA), fornito con biadesivo, peso 500 g

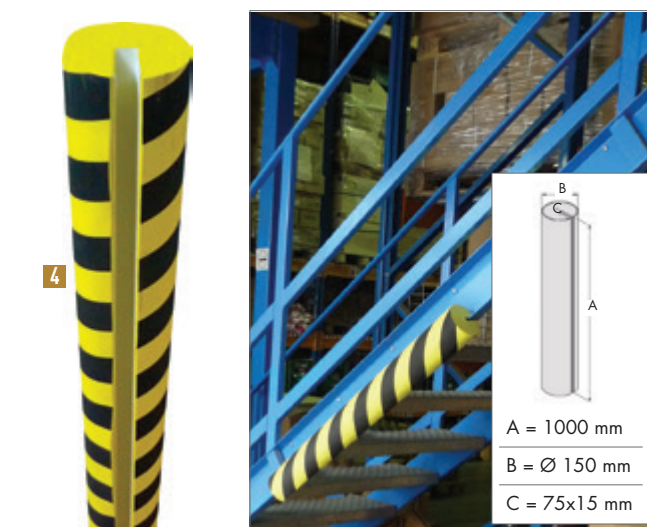

4 PARACOLPI ANGOLARE MULTIUSO

PGV702 - paracolpi in acetato (EVA), fornito senza biadesivo, peso 600 g

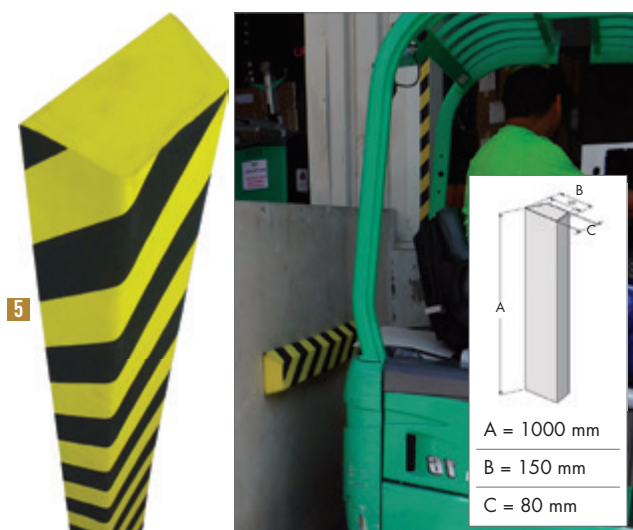

5 PARACOLPI TIPO PIATTO

PGV15080 - paracolpi in acetato (EVA), fornito con biadesivo, peso 300 g



6 PARACOLPI ANGOLARE LARGO

PGV7325 - paracolpi in gomma (NBR), fornito con biadesivo, peso 270 g

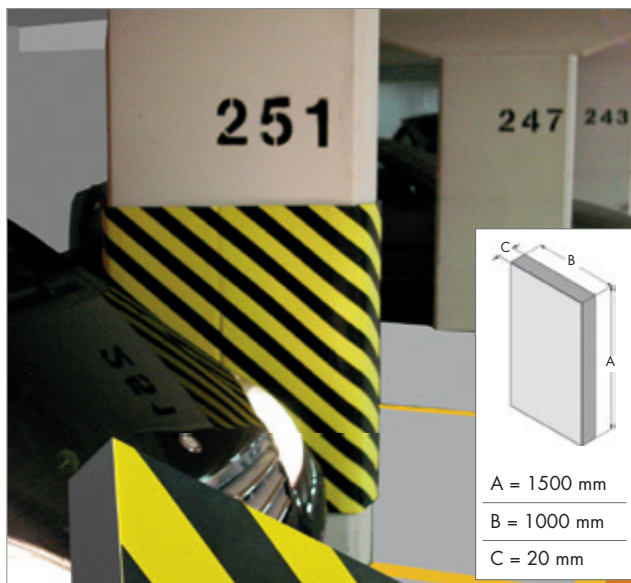
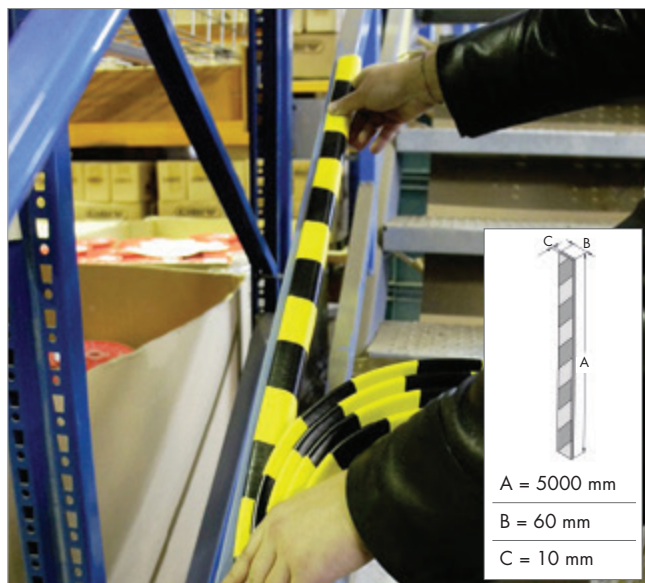

1 PARACOLPI IN ROTOLO DA 5 METRI

PGV500 - paracolpi in gomma (NBR), fornito con biadesivo, peso 840 g



2 PARACOLPI IN FOGLI

PGV1502 - paracolpi in gomma (NBR), fornito con biadesivo, peso 1350 g

RIFERIMENTO NORMATIVO (DECRETO LEGISLATIVO 81 DEL 09/04/08 TITOLO V)

- 1.1) Per segnalare i rischi di urto contro ostacoli, di cadute di oggetti e di caduta da parte delle persone entro il perimetro delle aree edificate dell'impresa cui i lavoratori hanno accesso nel corso del lavoro, si usa il giallo alternato al nero ovvero il rosso alternato al bianco.
- 1.2) Le dimensioni della segnalazione andranno commisurate alle dimensioni dell'ostacolo o del punto pericoloso che s'intende segnalare.
- 1.3) Le sbarre gialle e nere ovvero rosse e bianche dovranno avere un'inclinazione di circa 45° e dimensioni più o meno uguali fra loro.



3 PARACOLPI PER COLONNE

Per aree produttive e logistiche, assorbono e minimizzano danni e infortuni a persone e mezzi. Testate per resistere a colpi inferti da muletti (kg 3.855 a 8 km/h). Realizzate in polietilene ad alta densità, resistenti a sostanze chimiche. Disponibili per colonne tonde o quadrate (varie misure), si installano senza attrezzi, montaggio semplice. Fornite con due cinghie di tenuta con velcro.

PGJ1706 - paracolpi dimensioni cm 61 x 61 x 106,7 h per colonne Ø 15 cm, peso kg 18,2

PGJ1708 - paracolpi dimensioni cm 61 x 61 x 106,7 h per colonne Ø 20 cm, peso kg 18,2

PGJ1710 - paracolpi dimensioni cm 61 x 61 x 106,7 h per colonne Ø 25 cm, peso kg 18,2





BARRIERE IN POLIETILENE PER AREE INDUSTRIALI

d-flexx

safe

Caratteristiche

- Realizzate in polietilene flessibile, ritornano alla loro forma originale dopo una collisione.
- Riducono notevolmente i costi di riparazione e manutenzione.
- Ideali in magazzino, nei reparti produttivi e logistici.
- In polietilene 100% riciclabile.
- Adatti per uso esterno e interno.
- Facile installazione - fissaggi inclusi.
- Possibilità di realizzazioni su misura per le diverse esigenze dei clienti.

SICUREZZA DANESE!
TUTTI I PRODOTTI
D-FLEXX SONO
TESTATI. CONTATTACI
PER MAGGIORI
INFORMAZIONI,
SAREMO LIETI
DI AIUTARTI!



GUARDA
IL VIDEO!



SICUREZZA

A differenza delle barriere antiurto realizzate in metallo, gli innovativi prodotti antiurto d-flexx forniscono numerosi vantaggi.



FLESSIBILITÀ

Il polietilene assorbe in modo affidabile l'energia d'impatto di carrelli elevatori e autocarri industriali, rilasciandola quando il veicolo si allontana dal luogo dell'impatto.



DURATA

A differenza dell'acciaio, il polietilene non arrugginisce ed è quindi molto più durevole.



EFFICIENZA

Dopo una collisione, l'ambiente e i veicoli non rimangono danneggiati, riducendo i costi di manutenzione in modo duraturo nel tempo.

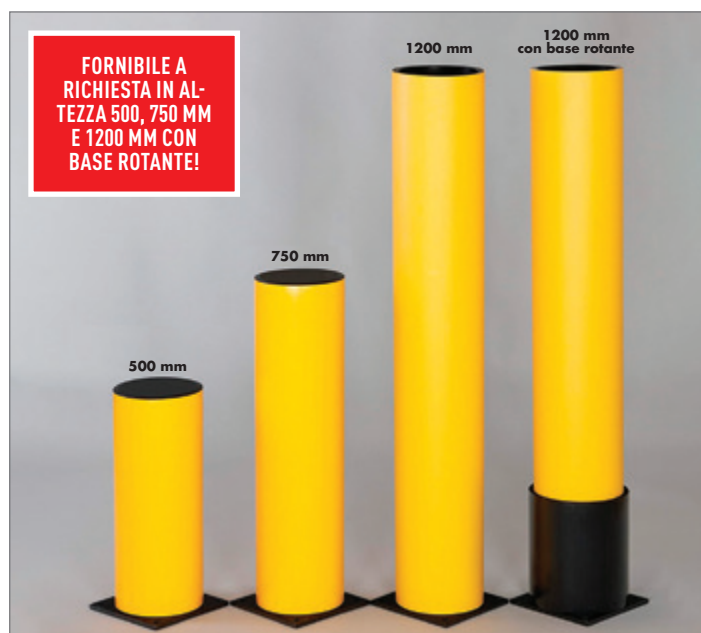

PALETTI DI PROTEZIONE IN POLIETILENE FLESSIBILE

Permettono di attutire gli impatti di muletti o eventuali altri danni, ritornando sempre alla loro forma originale. Antiruggine e resistenti agli agenti chimici, proteggono macchinari e attrezzature. Forniti con piastra di fissaggio da ancorare a terra.

- 1 DANB110** - paletto flessibile colore nero con bande rifrangenti applicate classe 2 colore giallo, dimensioni Ø mm 110 x 1200 h, peso 8,7 kg
- 2 DAN0510** - paletto flessibile, dimensioni Ø mm 200 x 1200 h, peso 16 kg. A richiesta fornibile in altezza 500 o 750 mm

I prodotti d-flexx sono distribuiti in Italia da:





PROGETTIAMO I TUOI SPAZI!

CON IL NOSTRO CONFIGURATORE
SAPREMO OFFRIRTI UN PROGETTO
COMPLETO E ADATTO ALLE TUE ESIGENZE.
RICHIEDI UN PREVENTIVO!

Perchè scegliere le barriere d-flexx?

1. Materiale polimerico flessibile

Le barriere antiurto flessibili d-flexx sono realizzate con uno speciale materiale polimerico flessibile, che assorbe la notevole energia rilasciata in caso di urto. Dopo una collisione, la barriera ritorna istantaneamente alla sua forma originale!

2. Elevato assorbimento di energia

I prodotti della gamma d-flexx assorbono gli impatti grazie al materiale polimerico flessibile. Nessuna energia viene diretta verso il pavimento: per questo motivo, le nostre barriere non si staccano dal suolo, evitando costose riparazioni del pavimento e tempi di fermo macchina.

3. Nessun danno su carrelli elevatori e transpallet

Niente più danni e graffi sui tuoi carrelli elevatori e transpallet. Grazie al materiale polimerico flessibile e alle forme arrotondate, in caso di collisione nessun veicolo verrà più danneggiato e gli urti saranno prevenuti efficacemente.

4. Notevole risparmio

Risparmia denaro con d-flexx. Nessun costo di sostituzione per danni da collisione, nessun danno al pavimento dovuto a strappi, nessuna riparazione, nessun fermo macchina.

5. Di addio alla ruggine e alle sorprese indesiderate!

Le nostre barriere non sono rivestite e/o laccate. Il materiale polimerico delle nostre barriere flessibili d-flexx viene colorato nelle prime fasi produttive. In questo modo non avrai mai più problemi con protezioni antiurto arrugginite e particelle volatili indesiderate!

6. Resistente agli agenti chimici

In ambienti di lavoro aggressivi, ad esempio nell'industria chimica o alimentare, dove è necessario soddisfare elevati requisiti di resistenza chimica e alla corrosione delle protezioni antiurto, l'acciaio è la scelta sbagliata. Con il suo materiale polimerico, d-flexx è completamente antiruggine ed estremamente resistente. La barriera è completamente chiusa, per impedire contaminazioni con particelle e parassiti indesiderati.

7. Alta visibilità

Di colore nero e giallo, le nostre barriere sono molto visibili anche da lontano. Presentare ai visitatori le tue macchine, i vialetti interni e gli scaffali perfettamente protetti, darà a loro un'ottima impressione della tua azienda.

8. Altamente modulare

d-flexx è modulare e può essere montato su qualsiasi superficie: inoltre c'è la possibilità di integrare angoli e porte, oltre a poter richiedere lunghezze personalizzate!





i IL POLIURETANO CONFERISCE A PALETTI E BARRIERE UNA GRANDE FLESSIBILITÀ E RESISTENZA ALL'IMPATTO, SENZA LIMITI DI DURATA NEL TEMPO. SONO UTILIZZABILI IN AREE INTERNE ED ESTERNE, DI COLORE GIALLO/NERO AD ALTA VISIBILITÀ.

ESTREMAMENTE FLESSIBILI E RESISTENTI!



1 BARRIERA DI DELIMITAZIONE FLESSIBILE IN POLIURETANO

Barriera antiurto Ø 80 mm, base rinforzata con piastrina d'acciaio, 4 punti di fissaggio, resistente a temperature da -0°C a +50°C. Offre un'eccellente protezione dai carrelli elevatori ad attrezzature e macchinari.

BARVP70 - barriera flessibile, dimensioni mm 800 x 150 x 120 h, peso 2,4 kg

BARVP71 - barriera flessibile, dimensioni mm 1180 x 150 x 120 h, peso 4,3 kg

BARVP72 - barriera flessibile, dimensioni mm 1980 x 150 x 120 h, peso 7,2 kg

PGRV13 - tasselli di fissaggio per cemento per BARVP70 e BARVP71 (necessari 8 pezzi) e per BARVP72 (necessari 12 pezzi)



ESTREMAMENTE FLESSIBILI E RESISTENTI!

2 BARRIERA DI PROTEZIONE IN POLIURETANO

Barriera di protezione Ø 80 mm in poliuretano flessibile, resistente agli urti e alla corrosione. Permette di proteggere macchinari, attrezzature, di attutire gli occasionali impatti di muletti o eventuali altri danni. Base rinforzata con piastre di fissaggio da ancorare a terra.

BARVP79 - barriera flessibile, dimensioni mm 1200 x 350 h, peso 8,5 kg

BARVP76 - barriera flessibile, dimensioni mm 1200 x 750 h, peso 10,2 kg

BARVP78 - barriera flessibile, dimensioni mm 1200 x 1000 h, peso 11,8 kg

PGRV13 - tasselli di fissaggio per cemento per BARVP76, BARVP78 e BARVP79 (necessari 8 pezzi)



ESTREMAMENTE FLESSIBILI E RESISTENTI!



BOCCOLA PER RENDERE LA COLONNINA ESTRAIBILE

COLONNINA ESTRAIBILE IN POLIURETANO

Colonnina di protezione industriale, altezza totale mm 1130, di cui 930 fuori terra, estraibile, in poliuretano, di colore giallo con due bande nere (h mm 120).

3 BARVP80 - colonnina industriale estraibile, dimensioni Ø mm 100 x 1130 h, peso 3,5 kg

4 BARVPB - boccola per colonnina industriale estraibile in poliuretano, peso 3 kg



ESTREMAMENTE FLESSIBILI E RESISTENTI!



5 PALETTI DI PROTEZIONE FLESSIBILE IN POLIURETANO

Paletto di protezione flessibile in poliuretano, resistente agli urti e alla corrosione. Permette di proteggere macchinari, attrezzature, di attutire gli occasionali impatti di muletti o eventuali altri danni. Con piastra di fissaggio da ancorare a terra.

BARVP73 - paletto flessibile, dimensioni Ø mm 140 x 700 h, peso 7 kg

BARVP75 - paletto flessibile, dimensioni Ø mm 160 x 1000 h, peso 7 kg

BARVP74 - paletto flessibile, dimensioni Ø mm 270 x 1000 h, peso 10,5 kg

PGRV13 - tasselli di fissaggio per cemento per BARVP73 (necessari 4 pezzi), BARVP74 e BARVP75 (necessari 8 pezzi)



PROTEZIONI PER MACCHINARI E AREE INDUSTRIALI IN ACCIAIO

Protezioni in acciaio Ø 76 spessore mm 3 con piastra di fissaggio (mm 160 x 140 x 10), verniciati colore giallo con bande nere. Tasselli per il fissaggio esclusi.

- 1 BARV6066** - barriera angolare mm 600 x 600 x 600 h, peso kg 15,5, colore giallo, con 5 bande colore nero
- 2 BARV6010** - barriera lineare mm 1000 x 600 h, peso kg 11,5, colore giallo, con 4 bande di colore nero

PGRV27 - tasselli di fissaggio per cemento per BARV6066 (necessari 12 pezzi) e per BARV6010 (necessari 8 pezzi)



3 BARRIERE IN ACCIAIO CON PIASTRA ANTINFORCAMENTO

Archetti con piastra protettiva incorporata, previene l'inforcamento dei muletti in corrispondenza di scaffalature o impianti di magazzino. Acciaio spessore mm 3, Ø mm 76, alta resistenza e qualità. Piastre di fissaggio alle basi mm 160 x 140. Tasselli per il fissaggio esclusi.

- BARV35** - archetto mm 1000 x 350 h, peso 11 kg
 - BARV36** - archetto mm 750 x 600 h, peso 13 kg
 - BARV37** - archetto mm 1000 x 600 h, peso 15,5 kg
- PGRV27** - tasselli di fissaggio x cemento per BARV35, BARV36 e BARV37 (necessari 8 pezzi)

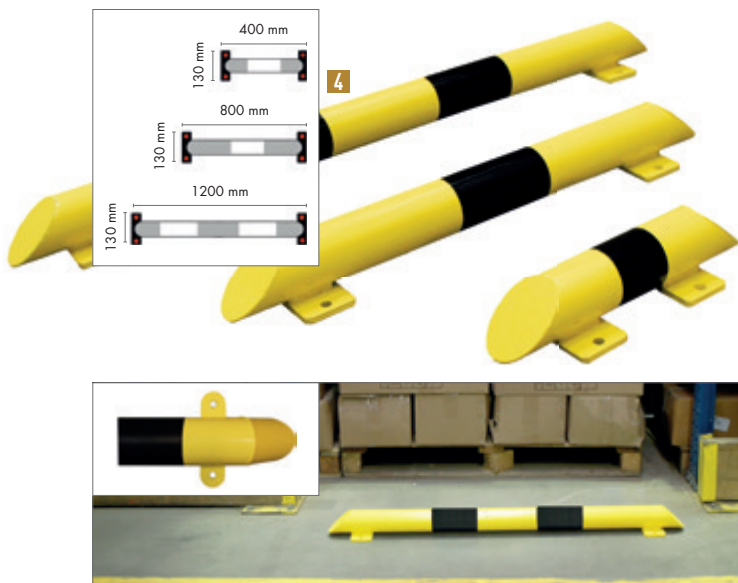

4 BARRIERE DI PROTEZIONE IN ACCIAIO

Barriere di protezione da fissare a pavimento. Idonee per delimitare le zone di passaggio e proteggere la parte bassa di installazioni, attrezzature. Estremità troncate a 45° per ridurre i rischi in caso di caduta. Realizzate in acciaio, Ø tubo mm 76. Tasselli per il fissaggio esclusi.

- BARV40** - barriera di protezione, dimensioni: mm 400 x 86 h, peso kg 3,5
 - BARV41** - barriera di protezione, dimensioni: mm 800 x 86 h, peso kg 4,5
 - BARV42** - barriera di protezione, dimensioni: mm 1200 x 86 h, peso kg 6,8
- PGRV27** - tasselli di fissaggio x cemento per BARV40, BARV41 e BARV42 (necessari 4 pezzi)



5 PALETTI DI PROTEZIONE IN ACCIAIO

Paletti di protezione in acciaio spessore mm 4 da fissare a pavimento. Robusti e resistenti, ideali per la protezione di scaffalature, attrezzature, angoli etc. Tasselli per il fissaggio esclusi.

- BARV90** - paletto di protezione Ø 90 mm, altezza 1200 mm, peso kg 10
 - BARV91** - paletto di protezione Ø 159 mm, altezza 1200 mm, peso kg 21
 - BARV92** - paletto di protezione Ø 273 mm, altezza 1200 mm, peso kg 48
- PGRV27** - tasselli di fissaggio x cemento per BARV90 (necessari 4 pezzi) e per BARV91 e BARV92 (necessari 6 pezzi)



SISTEMI DI PROTEZIONE IN ACCIAIO PER AREE INDUSTRIALI

1 BARRIERE DI SICUREZZA PER AMBIENTI INDUSTRIALI CON PIASTRA DI FISSAGGIO

Barriere in acciaio fornibili in 4 diverse colorazioni e 2 diametri:

- Ø 60 mm con **piastre di fissaggio** alla base (mm 1000 x 1000 h, base mm 150 x 150)
- Ø 40 mm con **piastre di fissaggio** alla base (mm 1000 x 1000 h, base mm 150 x 150)

Tasselli per il fissaggio da ordinare separatamente. A richiesta, tutte le barriere sono fornibili in lunghezze diverse: 1500 e 2000 mm

BARV600NY - barriera di sicurezza per ambienti industriali Ø 60 mm colore giallo/nero, peso 9,70 kg

BARV600RB - barriera di sicurezza per ambienti industriali Ø 60 mm colore bianco/rosso, peso 9,70 kg

BARV600Y - barriera di sicurezza per ambienti industriali Ø 60 mm colore giallo senza bande colorate, peso 9,70 kg

BARV600S - barriera di sicurezza per ambienti industriali Ø 60 mm in acciaio senza bande colorate, peso 9,70 kg

BARV402RB - barriera di sicurezza per ambienti industriali Ø 40 mm colore bianco/rosso, peso 6,80 kg

BARV402NY - barriera di sicurezza per ambienti industriali Ø 40 mm colore giallo/nero, peso 6,80 kg

BARV402Y - barriera di sicurezza per ambienti industriali Ø 40 mm colore giallo senza bande colorate, peso 6,80 kg

BARV402S - barriera di sicurezza per ambienti industriali Ø 40 mm in acciaio senza bande colorate, peso 6,80 kg

SISTEMI DI FISSAGGIO PER BARRIERE

PGRV25 - tasselli di fissaggio per asfalto 300 mm x Ø 12 mm (necessari 8 pezzi)

PGRV27 - tasselli di fissaggio per cemento 80 mm x Ø 12 mm (necessari 8 pezzi)



FORNIBILI IN 4 DIVERSE COLORAZIONI

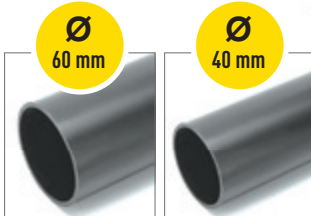

FORNIBILI IN 2 DIAMETRI DIVERSI

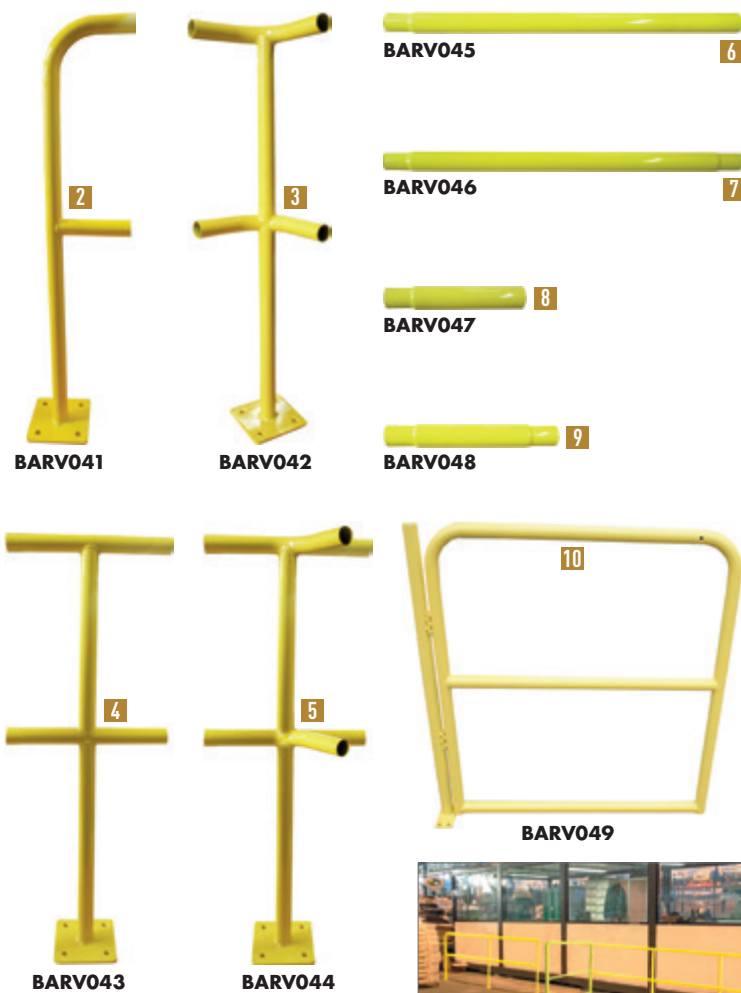

ELEMENTI DEL SISTEMA DI BARRIERE MODULARI

CODICE	DESCRIZIONE	DIMENSIONI (mm)	PESO (kg)
2 BARV041	Elemento iniziale	200	2,54
3 BARV042	Elemento angolare	200 x 200	3,06
4 BARV043	Elemento a 2 vie	380	3,11
5 BARV044	Elemento a 3 vie	380 x 200	3,51
6 BARV045	Estensione maschio/femmina	600 x 50	0,8
7 BARV046	Estensione maschio/maschio	600 x 50 x 50	0,8
8 BARV047	Estensione maschio/femmina	250 x 50	0,25
9 BARV048	Estensione maschio/maschio	250 x 50 x 50	0,25
10 BARV049	Porta con apertura in 2 direzioni	60 x 800 x 860	-

SISTEMA DI BARRIERA MODULARE

Ideale per proteggere le aree di lavoro (macchinari ed altre installazioni). Gli elementi sono realizzati in acciaio Ø 40 mm - altezza 1 mt e permettono di comporre barriere di sicurezza a seconda dei diversi ambienti industriali.

PGRV27 Tasselli di fissaggio per cemento 80 mm x Ø 12 mm (necessari 4 pezzi a base) 0,07

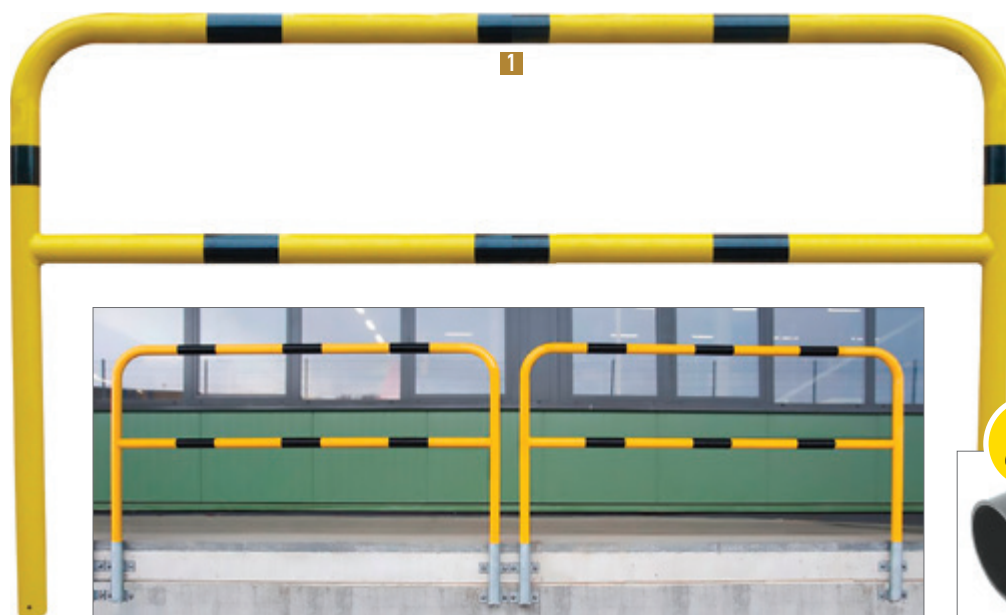

FORNIBILI
IN 3 DIVERSE
COLORAZIONI

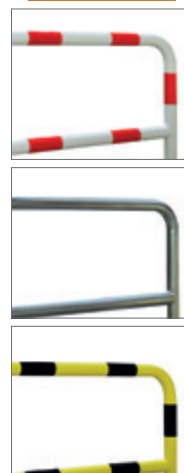

Ø
60 mm

1 BARRIERE DI SICUREZZA DA INTERRARE - LARGHEZZA 2 METRI

Barriere per ambienti industriali da interrare, larghezza 2 metri.

BARV702RB - barriera Ø 60 mm colore bianco/rosso, dimensioni mm 2000 x 1200 h, peso 12,7 kg

BARV702NY - barriera Ø 60 mm colore giallo/nero, dimensioni mm 2000 x 1200 h, peso 12,7 kg

BARV702S - barriera Ø 60 mm acciaio senza bande colorate, dimensioni mm 2000 x 1200 h, peso 12,7 kg

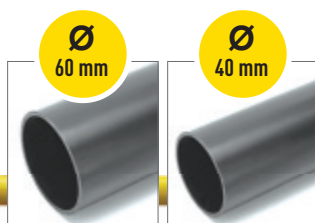

FORNIBILI IN 2 DIAMETRI DIVERSI

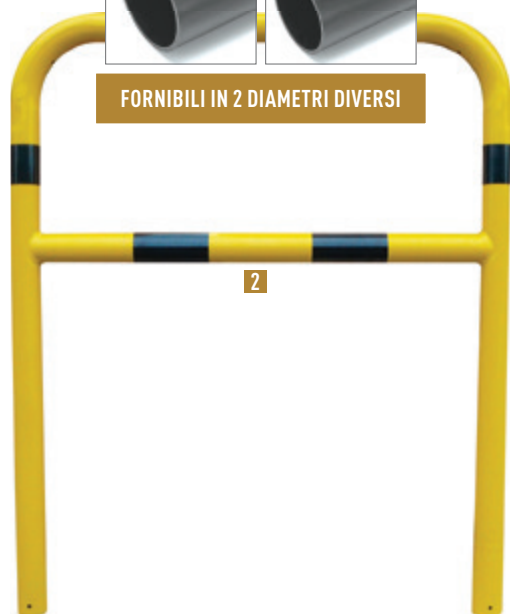

FORNIBILI
IN 3 DIVERSE
COLORAZIONI

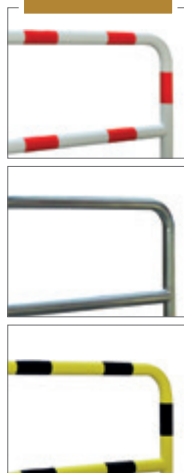

2 BARRIERE DI SICUREZZA DA INTERRARE - LARGHEZZA 1 METRO

Barriere per ambienti industriali da interrare, larghezza 1 metro.

BARV700RB - barriera di sicurezza da interrare Ø 60 mm colore bianco/rosso, dimensioni mm 1000 x 1200 h, peso 8,5 kg

BARV700NY - barriera di sicurezza da interrare Ø 60 mm colore giallo/nero, dimensioni mm 1000 x 1200 h, peso 8,5 kg

BARV700S - barriera di sicurezza da interrare Ø 60 mm acciaio senza bande colorate, dimensioni mm 1000 x 1200 h, peso 8,5 kg

BARV403NY - barriera di sicurezza da interrare Ø 40 mm colore giallo/nero, dimensioni mm 1000 x 1200 h, peso 5 kg

BARV403S - barriera di sicurezza da interrare Ø 40 mm acciaio senza bande colorate, dimensioni mm 1000 x 1200 h, peso 5,1 kg



BUSSOLE DI FISSAGGIO PER BARRIERE Ø 60 MM

3 **BARV73SB** - bussola per bordi singola, peso 4,5 kg

4 **BARV73DB** - bussola per bordi doppia, peso 7 kg

5 **BARV73DP** - bussola doppia, peso 4,8 kg

6 **BARV73SP** - bussola singola, peso 3,3 kg



BUSSOLE DI FISSAGGIO PER BARRIERE Ø 40 MM

7 **BARV43DB** - bussola per bordi doppia, peso 3,6 kg

8 **BARV43SB** - bussola per bordi singola, peso 1,8 kg

9 **BARV43DP** - bussola doppia, peso 3 kg

10 **BARV43SP** - bussola singola, peso 1,3 kg





D.M. 23/03/2000 - RICONOSCIMENTO DI CONFORMITÀ ALLE VIGENTI NORME DI MEZZI E SISTEMI DI SICUREZZA RELATIVI ALLA COSTRUZIONE E ALL'IMPIEGO DI SCALE PORTATILI POI MEGLIO DEFINITA ED INTEGRATA DA CIRCOLARE MINISTERIALE DEL 2004.

Regolamenta e riconosce la conformità alle vigenti norme delle scale portatili - D.Lgs 81/08 - a condizione che le scale portatili siano costruite conformemente all'Articolo 113 e in alternativa alla Norma Tecnica UNI EN131. Il costruttore che decide di realizzare le scale in accordo con la norma deve sottoporre la scala alle prove di certificazione presso un laboratorio ufficiale. Il "marchio ACAL EN 131" quindi garantisce il rispetto delle norme costruttive Europee del prodotto testato dal "Politecnico di Milano" quale organo di terza parte autorizzato.



1 PONTEGGI IN ALLUMINIO

Montanti in tubo tondo di alluminio Ø mm 42, gradino antisdrucchiolo in tubo tondo di alluminio Ø mm 42, ruote girevoli con freno Ø mm 125. Dimensione base mm 1820 x 1000. Dimensione base (con staffoni laterali) mm 2900 x 1750. Altezza base mm 1950. Altezza campata da mm 1200 e da mm 1800. Piano di lavoro con sistema antifvento da mm 1500 x 620. Portata (comprese due persone) max kg 200. **Costruito in conformità alla norma europea UNI EN 1004: uso previsto senza ancoraggio all'interno fino a 12 m, all'esterno fino a 8 m.**

HSP320 - ponteggio, altezza totale m 1,95, altezza al piano m 1, altezza di lavoro m 3, 2 elementi base con ruote, 1 snodo e 1 piano di lavoro

HSP321 - ponteggio, altezza totale m 3,75, altezza al piano m 2,75, altezza di lavoro m 4,75, 2 elementi base con ruote, 1 snodo, 1 piano di lavoro, 2 ringhiere, 1 traversa base, 2 diagonali, 2 elementi prolunga da m 1,80, 1 fermapiedi, 4 staffoni

HSP322 - ponteggio altezza totale m 4,95, altezza al piano m 3,75, altezza di lavoro m 5,75, 2 elementi base con ruote, 1 snodo, 1 piano di lavoro, 2 ringhiere, 1 traversa base, 2 elementi prolunga da m 1,20, 4 diagonali, 2 elementi prolunga da m 1,80, 1 fermapiedi, 4 staffoni

A RICHIESTA SI FORNISCONO DIVERSE TIPOLOGIE DI PONTEGGI E SCALE, PER SODDISFARE LE MOLTEPLICI ESIGENZE LAVORATIVE.



APERTURA 50 MM

SCALA IN CORDA

Scala in corda costruita con montanti in fune di nylon e gradini in alluminio antisdrucchiolo. Montanti in fune di nylon diametro mm 16; gradini in alluminio antisdrucchiolo pioli diametro mm 25; ganci in alluminio a norma EN362; larghezza esterna diametro mm 350. Carico massimo kg 100. **Conforme alla normativa italiana D.Lgs 81/2008 Articolo 113.**

2 HSP15 - solo scala in corda (specificare i metri necessari). Ganci e moschettoni non inclusi (da ordinare separatamente)

3 HSPG - coppia di ganci e moschettoni in alluminio a norma EN362

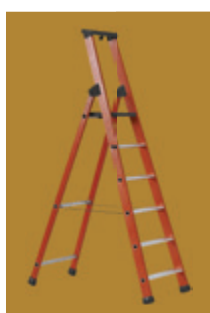

A RICHIESTA FORNIBILI SCALE IN VETRORESINA, ISOLAMENTO ELETTRICO 20.000 VOLT/CM², CONFORMI ALLA NORMA EUROPEA UNI EN131.

1 SCALA APRIBILE IN ALLUMINIO

Con piattaforma da 270 x 250 mm in polipropilene. Gradini piani da 80 mm fissati ai montanti con risbordatura triangolare. Dotata di vaschetta portaoggetti in polipropilene, tappi antisdrucchiolanti alla base da 70 x 20 mm e cinghie antiapertura. Per applicazioni industriali e pulizie. Carico max kg 150. **Conforme alla norma europea UNI EN131.** A richiesta fornibili in altre esecuzioni.

HSP070 - 2 gradini + piattaforma; altezza piattaforma cm 68; altezza chiusa cm 136; peso kg 4,9

HSP200 - scala a 4 gradini + piattaforma; altezza piattaforma cm 114; altezza chiusa cm 186; peso kg 6,6

HSP141 - scala a 5 gradini + piattaforma; altezza piattaforma cm 137; altezza chiusa cm 211; peso kg 7,6

HSP250 - scala a 6 gradini + piattaforma; altezza piattaforma cm 160; altezza chiusa cm 236; peso kg 8,5

HSP350 - scala a 10 gradini + piattaforma; altezza piattaforma cm 253; altezza chiusa cm 336; peso kg 13,5



SPESE DI TRASPORTO DA CONCORDARE

PIANETTO DI LAVORO OPZIONALE (COD. HSP66P)



SCALA MOBILE A PALCHETTO

Completamente smontabile ideale per la manutenzione di ampie superfici in quota. Estremamente versatile ha la possibilità di avere l'uscita frontale, laterale destra/sinistra e, possibilità di aumentare l'altezza del parapetto e di inserire un secondo piano di lavoro intermedio innalzandone l'altezza. **Conforme al D.Lgs 81/2008.** Carico massimo kg 150. Fornita smontata. Secondo pianetto di lavoro con ulteriore ringhiera fornibile a richiesta.

- 1 **HSP660** - piattaforma, dimensioni (l x l x h) 600 cm x 1 m x 2 m
- HSP661** - piattaforma, dimensioni (l x l x h) 600 cm x 1 m x 2,25 m
- HSP662** - piattaforma, dimensioni (l x l x h) 600 cm x 1 m x 2,50 m
- HSP681** - piattaforma, dimensioni (l x l x h) 800 cm x 1 m x 2 m
- HSP682** - piattaforma, dimensioni (l x l x h) 800 cm x 1 m x 2,25 m
- HSP683** - piattaforma, dimensioni (l x l x h) 800 cm x 1 m x 2,50 m
- 2 **HSP66P** - secondo pianetto di lavoro (opzionale) lunghezza 500 cm per piattaforma da 1 m di lunghezza

A RICHIESTA FORNIBILI PIATTAFORME DI LUNGHEZZA FINO A 3 E 4 METRI DI ALTEZZA.



SPESE DI TRASPORTO DA CONCORDARE



4 SCALA A CASTELLO IN ALLUMINIO

Scala in alluminio pieghevole con un **ingombro ridotto per il trasporto e lo stoccaggio**. Caratteristiche tecniche: montanti rettangolari da mm 84 x 25; montante strutturale parte posteriore mm 67 x 25; gradini piani con superficie antiscivolo da mm 130; alzata mm 250; allargatori telescopici nella parte posteriore; barra stabilizzatrice smontabile con 2 ruote da mm 150 per agevolare gli spostamenti; piano di calpestio in lamiera mandorlata da mm 600 x 465; parapetto di protezione da m 1; fermapiè da mm 150; vaschetta porta oggetti in ABS da mm 480 x 190. **Conforme alla normativa italiana D.Lgs 81/2008 Art. 113.**

HSP140 - scala castello n° gradini 8 (compresa piattaforma), altezza totale m 3, altezza piattaforma m 2, altezza lavoro m 4,0

HSP139 - scala castello n° gradini 10 (compresa piattaforma), altezza totale m 3,50; altezza piattaforma m 2,50, altezza lavoro m 4,50



3



3 SCALA A CASTELLO IN ALLUMINIO EN131

Realizzata con sistemi diversi di stabilizzazione a seconda dell'altezza. Per scale a 3 e 4 gradini allargatore posteriore integrato; per scale da 5 a 9 gradini stabilizzatori telescopici diagonali oltre ad allargatore posteriore integrato; per scale da 10 a 15 gradini sistema di stabilizzatori laterali oltre ad allargatore posteriore integrato. **Scala fornita smontata e piegata** per ridurre le spese di trasporto. Profilo montante anteriore mm 84 x 25; profilo montante posteriore mm 67 x 25; gradino mm 130 di profondità innestato, espanso e ribordato nei montanti; larghezza gradino mm 600; 2 ruote Ø mm 150; vaschetta porta oggetti da mm 600 x 180; piano di calpestio in lamiera mandorlata da mm 600 x 450.

HSP131 - scala castello **EN131**, n° gradini 7 (compresa piattaforma), altezza totale m 2,75, altezza piattaforma m 1,75, altezza lavoro m 3,75, peso kg 32

HSP132 - scala castello **EN131** n° gradini 9 (compresa piattaforma), altezza totale m 3,25, altezza piattaforma m 2,25, altezza lavoro m 4,25, peso kg 38



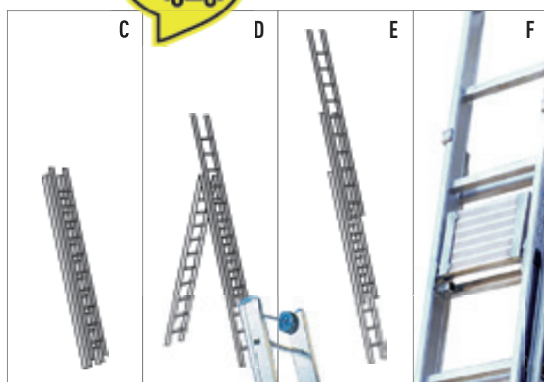

CORRIMANO
FORNIBILE A
RICHIESTA.



1 SCALA TELESCOPICA

Dimensioni compatte per un miglior trasporto e stoccaggio. Particolarmente maneggevole e resistente, **fornita con allargatore (A) obbligatorio in base alla normativa europea UNI EN131 a partire da cm 300 h.** Può essere utilizzata anche come scala aperta, "zoppa" (B) (presenza di dislivello fra i due tronchi) o d'appoggio. Ideale per squadre di manutenzione con mezzi di trasporto. Carico massimo kg 150. **Conforme alla normativa europea UNI EN131.**

HSC127A - scala telescopica a gradini: 4 x 2 interni e 4 x 2 esterni; h chiusa cm 127; h aperta cm 203; h a sfilo cm 425; larghezza cm 55; peso kg 11,5

HSC157A - scala telescopica a gradini: 5 x 2 interni e 5 x 2 esterni; h chiusa cm 157; h aperta cm 260; h a sfilo cm 546; larghezza cm 61; peso kg 14,6

2 SCALA COMPONENTE

Versatile, utilizzabile chiusa (C), aperta (D) e a sfilo (E). **Fornita con pianetto (F)** a garanzia di migliore equilibrio per l'utilizzatore. Gradini antiscivolo e montanti progettati secondo EN131 (100 mm per altezza comprese tra 3,5 e 4,5 m - 84 mm per 3 m - 67 mm tra 2 e 2,5 m). Con dispositivo antiribaltamento laterale, gancio antisfilo accidentale ed dispositivo antiapertura/antichiusura. Carico massimo kg 150. **Conforme alla normativa europea UNI EN131.**

HSS250G - scala componibile in 3 tronchi da 8 gradini ciascuno; h chiusa cm 257; h aperta cm 248; h a sfilo cm 560; larghezza cm 46; peso kg 19

HSS300G - scala componibile in 3 tronchi da 10 gradini ciascuno; h chiusa cm 317; h aperta cm 308; h a sfilo cm 740; larghezza cm 46; peso kg 25

SCALA D'APPOGGIO

Montanti in lega leggera e gradino fissato al montante con il sistema della risbordatura. La sua caratteristica principale è la robustezza, ideale per uso professionale. A richiesta zoccolini antiscivolevoli snodati alla base (mm 120 x 60). Per applicazioni di edilizia e agricoltura. Carico massimo kg 150.

3 HSC300 - scala d'appoggio con 9 gradini; h cm 300; larghezza cm 41; peso kg 6,6. **Conforme alla normativa italiana D.Lgs 81/2008 Art. 113.**

HSC400 - scala d'appoggio con 13 gradini; h cm 400; larghezza cm 41; peso kg 8,8. **Conforme alla normativa italiana D.Lgs 81/2008 Art. 113.**

4 HSC350 - scala d'appoggio con 11 gradini; h cm 350; larghezza cm 41; peso kg 7,6. **Conforme alla normativa europea UNI EN131.**

! LE SCALE NELLE IMMAGINI RAFFIGURANO IL MODELLO E POSSONO DIFFERIRE IN ALCUNE CARATTERISTICHE PRESENTI NEI TESTI (ES. NUMERO DEI GRADINI).



SCALA DI PARTENZA

MODULO INTERMEDIO

MODULO DI SBARCO



A RICHIESTA REALIZZIAMO PREVENTIVI PER SCALE A GABBIA PER QUALSIASI TIPO DI EDIFICIO.



A RICHIESTA FORNITA SMONTATA PER RIDURRE I COSTI DI SPEDIZIONE (COMPLETA DI LIBRETTO ISTRUZIONI ASSEMBLAGGIO).



6 SGABELLO A GRADINI

Realizzato in resina sintetica multibase, l'garantisce elevata resistenza meccanica e ottima resistenza agli urti e alle deformazioni sotto carico. Forte resistenza allo schiacciamento, e tappetini antiscivolo molto resistenti. Stabile, conveniente e sicuro, il prodotto si presenta suddiviso in due parti e il montaggio avviene per semplice pressione sulla parte superiore.

NVP901 - sgabello a gradini, carico massimo 150 kg



SCALE A GABBIA MODULARI PER LAVORI IN QUOTA

Fornite smontate (con libretto di istruzioni per il montaggio) e di semplice assemblaggio. Composte da elementi modulari indipendenti di lunghezze variabili, ancorati tra loro con sistema a baionetta fissata con gradino passante che la rende un corpo unico con il montante, garantendo solidità e sicurezza di collegamento. Apposite staffe fissano le scale a muro, fissando una distanza di cm 15 dalla superficie di risalita. Le gabbie modulari sono realizzate con elementi circolari Ø mm 600, collegabili alla scala tramite inserti in nylon ad espansione e piatti di giunzione forati. La partenza della gabbia è sempre tra i 2 e i 2,5 metri. **Le scale possono essere fornite a tronco singolo fino a m 8,00 come consigliato dalla normativa italiana D.Lgs.81/2008 o (se superiori) a più tronchi con appositi moduli di sdoppiamento e piattaforme di riposo.** Fornibili a richiesta scale fino a 18 mt di altezza totale. Le scale a gabbia vengono fornite complete di: scala fissa di partenza (A), moduli intermedi (B), modulo sbarco (C) e accessori (cerchi e piatti), **staffe escluse da ordinare separatamente.**

1 HSP508 - scala a gabbia completa, altezza allo sbarco m 8, h totale m 9,16 (staffe escluse, necessarie 4 coppie)

HSP506 - scala a gabbia completa, altezza allo sbarco m 6, h totale m 7,16 (staffe escluse, necessarie 3 coppie)

2 HSPST1 - coppie staffe (necessaria 1 coppia ogni 2 mt)

Accessori:

3 HSPST2 - coppie di staffe telescopiche (necessarie se presenti impedimenti sulle superfici di risalita) da abbinarsi a un gradino d'uscita **HSPGR1**

4 HSPB01 - botola antintrusione, predisposta per chiusura con lucchetto ad arco lungo per inglobare le due estremità (non fornito)

5 HSPGR1 - gradino d'uscita in alluminio da mm 150, permette di sbarcare in sicurezza per non avere il vuoto tra scala e muro

i RICHIEDERE UN PREVENTIVO PER SCALE CON ALTEZZE DIVERSE DA QUELLE INDICATE.

SCALE SGABELLO

Leggerissime e molto maneggevoli con una struttura completamente in alluminio. Ampi gradini con rigatura antiscivolo a scomparsa.

7 HSP02 - 2 gradini profondi cm 20; altezza piattaforma cm 49,5; peso kg 4,6; ingombro chiuso cm 80 x 51,5 x 8. Carico massimo kg 150, **conforme al D.Lgs 81/2008 e alla normativa europea UNI EN 14183**

8 HSP03 - 3 gradini profondi cm 20; altezza piattaforma cm 73,5; peso kg 6,5; ingombro chiuso cm 112 x 53 x 8. Carico massimo kg 150, **conforme al D.Lgs 81/2008 e alla normativa europea UNI EN 14183**

9 HSP04 - 4 gradini profondi cm 20; altezza piattaforma cm 99; peso kg 8,7; ingombro chiuso cm 144 x 54 x 8. Carico massimo kg 100, **conforme al D.Lgs 81/2008 e alla normativa europea UNI EN 14183**

10 HSP05 - modello con parapetto, 3 gradini profondi cm 20; altezza piattaforma cm 75; peso kg 7,9; ingombro chiuso cm 165 x 52 x 7. Carico massimo kg 150, **conforme al D.Lgs 81/2008 e alla normativa europea UNI EN 14183**

11 HSP06 - modello 3 gradini con piano di calpestio cm 42 x 60, 2 ruote da cm 15, altezza totale cm 75, peso kg 11. Carico massimo kg 100, **conforme al D.Lgs 81/2008**



CARRELLI, BILANCE E PANNELLI PORTA ATTREZZI PER MAGAZZINO



1



2

CARRELLI

Struttura in profili angolari in lamiera d'acciaio sezione mm 40 x 40, spessore 15/10, ripiani in lamiera spessore 12/10 piegata, saldata e provvista di rinforzo nella parte inferiore. Maniglione di spinta in tubolare ricoperto in gomma. 2 ruote Ø mm 100 con staffe girevoli e 2 ruote Ø mm 100 con staffa fissa. Portata kg 200. Colore blu RAL 5015.

1 ARBC71 - carrello, dimensioni cm 90 x 50 x 87 h, con 2 ripiani. Peso kg 17

2 ARBC73 - carrello, dimensioni cm 90 x 50 x 87 h, con 3 ripiani. Peso kg 21



3

4

5

CARRELLO A PIANALE

In lamiera d'acciaio di prima scelta con spessore 12/10 rinforzata. Sponda in tubolare d'acciaio. 2 ruote fisse e 2 ruote girevoli da Ø mm 125, ricoperte in gomma. Portata kg 300. Colore blu RAL 5015.

3 ARBC27 - carrello, dimensioni cm 140 x 70 x 97 h. Peso kg 32

4 ARBC28 - carrello, dimensioni cm 120 x 70 x 97 h. Peso kg 29

5 ARBC29 - carrello, dimensioni cm 100 x 70 x 97 h. Peso kg 24,5



6

6 BILANCIA CONTAPEZZI

Bilancia conta pezzi, compatta, ideale per inventari. Display multiplo a 3 display LCD retro illuminato per la visualizzazione di peso, peso medio unitario e numero pezzi. Tastiera impermeabile. Funzioni: conteggio pezzi, inserimento libero di pezzi di campionamento, inserimento peso medio unitario, memoria per 7 PMU richiamabili. Piatto in acciaio inox. Piedini regolabili e bolla di livello. Alimentazione: con batteria interna ricaricabile (autonomia 100 h circa) e con alimentatore di rete a 230 Volt in dotazione. Portata massima: 6 kg. Divisione: 0,2 gr. Peso medio unitario prodotto da contare: 0,1 gr raccomandato. Dimensione piatto: 235 x 335 mm. Peso 4 kg.

MGG890 - bilancia contapezzi



7

8

9

CARRELLI IN ALLUMINIO

7 HSC522 - carrello portacasse e scatole **fino a kg 120**, 1130 x 580 x 450 mm; pedana 305 x 190 mm, ruote pneumatiche Ø 260 x 85 mm, peso kg 6

8 HSC523 - carrello portacasse e scatole **fino a kg 200**, 1190 x 610 x 450 mm; pedana 450 x 180 mm, ruote pneumatiche Ø 260 x 85 mm, peso kg 7,5

9 HSC524 - carrello portasacchi, bidoni e bombole **fino a kg 200**, 1300 x 500 x 600 mm; pedana 290 x 395 mm, ruote pneumatiche Ø 260 x 85 mm, peso kg 9,2

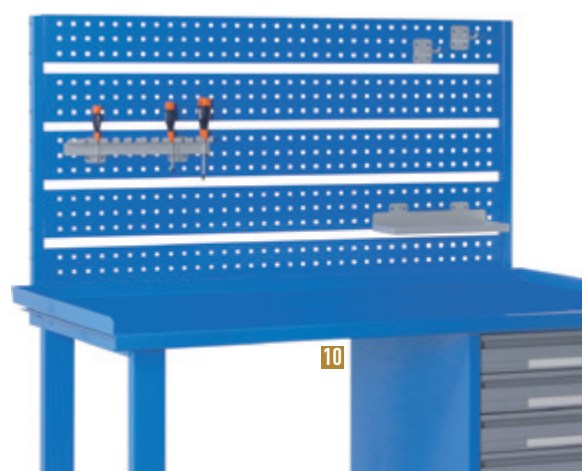

10

10 PANNELLI PORTA ATTREZZI

Pannelli amovibili in lamiera spessore 15/10 con fori a sezione quadrata mm 10 x 10 e passo mm 38. Montanti portanti in tubolare d'acciaio sezione mm 30 x 30 x 1,5. Per tutti i modelli di tavolo. Colore blu RAL 5015. I gancetti e le mensole raffigurate sono esclusi dalla fornitura e sono fornibili a richiesta.

ARBP10 - pannello porta attrezzi cm 100 x 80 h

ARBP15 - pannello porta attrezzi cm 150 x 80 h

ARBP20 - pannello porta attrezzi cm 200 x 80 h



Tavoli da lavoro

Struttura monolitica in tubolare d'acciaio sezione 80 x 40 mm, spessore 20/10 e lamiera presso piegata spessore 15/10. Il piano inferiore con cornice perimetrale, qualora previsto, è in tubolare sagomato e coperto con pannello in lamiera zincata. Forniti montati.



1 TAVOLI CON BORDO DI CONTENIMENTO SUI 3 LATI

Piano di lavoro in lamiera spessore 25/10 pressopiegata. Bordo di contenimento sui 3 lati.

ARBT11 - tavolo, dimensioni cm 100 x 75 x 88 h. Colore blu RAL 5015

ARBT12 - tavolo, dimensioni cm 150 x 75 x 88 h. Colore blu RAL 5015

ARBT13 - tavolo, dimensioni cm 200 x 75 x 88 h. Colore blu RAL 5015

2 TAVOLI SENZA BORDO DI CONTENIMENTO

Piano di lavoro in lamiera spessore 25/10 pressopiegata. Superficie totalmente piana.

ARBT21 - tavolo, dimensioni cm 100 x 75 x 88 h. Colore blu RAL 5015

ARBT22 - tavolo, dimensioni cm 150 x 75 x 88 h. Colore blu RAL 5015

ARBT23 - tavolo, dimensioni cm 200 x 75 x 88 h. Colore blu RAL 5015

TAVOLI CON PIANO IN MULTISTRATO DI FAGGIO

Piano di lavoro in legno multistrato di faggio, spessore 40 mm. Colore blu RAL 5015 e faggio naturale.

3 Con piano inferiore:

ARBT31 - tavolo, dimensioni cm 100 x 75 x 88 h

ARBT32 - tavolo, dimensioni cm 150 x 75 x 88 h

ARBT33 - tavolo, dimensioni cm 200 x 75 x 88 h

4 Senza piano inferiore:

ARBT41 - tavolo, dimensioni cm 100 x 75 x 88 h

ARBT42 - tavolo, dimensioni cm 150 x 75 x 88 h

ARBT43 - tavolo, dimensioni cm 200 x 75 x 88 h

Cassettiere

In lamiera d'acciaio spessore 8/10 piegata e saldata, colore grigio RAL 7001. Cassetti scorrevoli su guide telescopiche a ricircolo di sfere, con portata di kg 35 per i cassetti h cm 10 e kg 45 per i cassetti h cm 15. Portacartellino a tutta lunghezza. Con serratura tipo Yale a 2 chiavi. Le cassettiere si possono posizionare a scelta lateralmente o centralmente (sistemi di fissaggio inclusi nella fornitura).



CASSETTIERE

5 ARBC54 - cassettiere da appoggio, cm 50 x 66 x 66 h con 4 cassetti h cm 15. Peso kg 40 circa

6 ARBC52 - cassettiere da appoggio, cm 50 x 66 x 66 h con 2 cassetti h cm 15 + 3 cassetti h cm 10. Peso kg 40 circa

7 ARBC62 - cassettiere pensile cm 50 x 60 x 36 h con 2 cassetti h cm 15. Peso kg 17 circa

8 ARBC63 - cassettiere pensile cm 50 x 66 x 36 h con 3 cassetti h cm 10. Peso kg 17 circa



1

1 POLIETILENE A BOLLE D'ARIA

Formato da migliaia di bolle d'aria imprigionate fra due fogli di politene saldati, garantisce un imballo sicuro. Morbido e leggero, avvolge e protegge oggetti di qualsiasi forma e dimensione. **Antiurto** - assorbe ogni urto o vibrazione, **resistente** - non si deforma sotto l'azione di urti anche se ripetuti e resiste alla lacerazione, **impermeabile** - protegge perfettamente i vostri prodotti da umidità e polvere. Termosaldabile, inodore, chimicamente neutro, atossico e impermeabile. Bolla d'aria standard Ø 10 mm, spessore 4 mm.

MGG100 - rotolo da 20 kg circa, 115 gr/m², altezza 100 cm



2

3

2 TENDIREGGA A BATTERIA RICARICABILE

Un apparecchio ideale per reggiature normali, verticali e orizzontali, necessarie in tutte le industrie. Il tendiregga elettrico è idoneo per reggiare su colli piani. Alta affidabilità della giunzione. Per reggette da 15 - 16 mm, spessore reggette 0,5 - 0,8 mm. Caricabatteria a ricarica rapida 230V 50 Hz. Batteria al litio 14,4 VCD 2,6 Ah (Long life, 3000 ricariche). Peso 4,5 kg.

2 MGG016 - tendiregga a batteria corredato di batteria e caricabatteria

3 MGG160 - confezione da 3000 sigilli in acciaio lucido bulinato per reggette in plastica



4

4 PORTAROTOLI PER REGGETTE IN PLASTICA

I carrelli portarotolo sono studiati per il trasporto e un più agevole svolgimento delle bobine di reggetta in plastica e poliestere. Struttura in lamiera verniciata, cassetto porta tendiregga e sigilli. Adatti per rotoli di reggette in plastica e poliestere con Ø interno mm 400.

MGG400 - portarotoli per reggette



5

5 TENDIREGGA A LEVE LUNGHE

Tendiregga manuale per reggetta in plastica o polipropilene con larghezza mm 15, modello con leve lunghe in acciaio stampato con comode manopole per sforzi di chiusura ridotti, robusta base di appoggio, cricchetto tenditore, dopo la chiusura del sigillo le leve hanno anche la funzione di taglio della reggetta.

MGG316 - tendiregga a leve lunghe per reggette in plastica MGG508



6

6 REGGE IN PLASTICA

Regge in polipropilene con superficie gofrata per impieghi manuali. Spessore 0,8 mm. Carico di rottura 28 - 32 kg/mm². Allungamento 15 - 25%. Recupero elastico 90 - 95%. Ø interno anima in cartone mm 400.

MGG508 - rotolo lunghezza 1500 mt di reggia nera manuale in polipropilene 15 x 8 mm per MGG316

MGG509 - rotolo lunghezza 1500 mt di reggia nera automatica in polipropilene 15 x 8 mm per MGG316



1



1 TRANSPALLET PORTATA KG 2500

Transpallet in acciaio elettrosaldato, pompa idraulica con valvola di sicurezza per evitare i sovraccarichi. Timone con leva a tre posizioni: salita, discesa e neutro. Dimensioni forche: larghezza 540 x lunghezza: 1150 mm, altezza abbassate 85 mm, altezza alzate 200 mm. Ruote in poliuretano Ø 200 mm, rulli doppi in poliuretano Ø 80 x 70 mm.

MGG611 - transpallet portata kg 2500



2



2 TRANSPALLET CON BILANCIA

Telaio in acciaio elettrosaldato verniciato a forno. Timone con leva a 3 posizioni: salita/discesa/neutro, ruote e doppi rulli in poliuretano. Pesatura elettronica con 4 celle di carico e precisione +/- 0,2% della portata. Spegnimento automatico programmabile. Funzioni: netto/lordo, totalizzazione pesi, controllo +/-, pesata percentuale, conteggi. Indicatore di peso con display LCD retroilluminato a 6 cifre da 25 mm. Alimentazione 4 batterie AA, con cassetto estraibile, anche ricaricabili. Autonomia fino a circa 40 ore di funzionamento continuo oppure 3 mesi per uso tipico non continuativo, grazie alla funzione di auto spegnimento. Divisione kg 1 fino a kg 2000. Altezza forche abbassate 85 mm, altezza forche alzate 200 mm.

MGG610 - transpallet con bilancia, larghezza forche 550 mm, lunghezza forche 1170 mm



3

3 SALDATRICI PER SACCHETTI IN POLIETILENE

Saldatrici a impulsi temporizzati che saldano e sigillano ermeticamente buste e sacchetti con spessore fino a 150 my e larghezza massima di 200, 300 mm. Posizionato il sacchetto, l'operatore dovrà abbassare solamente la barra saldante e attendere alcuni secondi (1- 4), fino a quando la spia luminosa indicherà che la saldatura è stata effettuata. Tempo di saldatura regolabile in funzione del tipo e dello spessore del sacchetto. Imballo in scatola completo di istruzioni e due lame saldanti di ricambio.

MGG200 - saldatrice a leva mm 200

MGG201 - saldatrice a leva mm 300



4

4 SACCHETTI IN POLIETILENE CON CHIUSURA A PRESSIONE SEALGRIP

In polietilene bassa densità con chiusura a pressione. Mantengono inalterata l'efficacia di chiusura anche dopo innumerevoli chiusure e riaperture. Speciale profilo di chiusura a incastro che garantisce un'efficace e resistente sigillatura del sacchetto. Confezione da 100 sacchetti. Ordine minimo 20 confezioni.

MGGT10 - confezione da 100 sacchetti Sealgrip cm 7 x 10

MGGT12 - confezione da 100 sacchetti Sealgrip cm 8 x 12

MGGT23 - confezione da 100 sacchetti Sealgrip cm 16 x 23



5

5 SACCHETTI IN POLIETILENE

Sacchetti in polietilene economici, robusti, trasparenti, ideali per uso alimentare. Polietilene 100% riciclabile. Spessore 40 my. Realizzati da film tubolare con saldature sul fondo. Venduti in confezione da 50 pezzi. Ordine minimo 10 confezioni.

MGG515 - 50 sacchetti cm 10 x 15

MGG525 - 50 sacchetti cm 15 x 25

MGG530 - 50 sacchetti cm 20 x 30



BUSTE PER MAGAZZINI E BAULI



1 BUSTE MAGNETICHE PER DOCUMENTI

Buste realizzate in PVC trasparente indicate per contenere documenti. Magnete ad alto aggrappaggio e barra di irrigidimento colore blu. **Minimo ordinabile 5 pezzi/multipli.**

DIMENSIONI DELLE BUSTE MAGNETICHE

CODICE	DIMENSIONI (l x h)
BUSTA4VB	210 x 297 mm (formato A4 verticale)
BUSTA4OB	297 x 210 mm (formato A4 orizzontale)
BUSTA5OB	210 x 150 mm (formato A5 orizzontale)
BUSTA6B	105 x 150 mm (formato A6 verticale)
BUSTA7B	105 x 75 mm (formato A7 orizzontale)



2 PINZA MAGNETICA

Pinza portadocumenti in metallo, adatta per documenti di vari formati. Dimensione Ø mm 20, larghezza pinza mm 40.

PINZ20 - pinza magnetica portadocumenti



3 BUSTE ADESIVE PORTADOCUMENTI

Buste idonee a proteggere i documenti che accompagnano le spedizioni (bolle, fatture, istruzioni, ecc). Realizzate in polietilene 60 micron. Buona adesione su cartone, plastica, vetro e metallo.

BUS125 - confezione da 1000 buste portadocumenti mm 235 x 125

BUS175 - confezione da 1000 buste portadocumenti mm 235 x 175



BUSTE PORTADOCUMENTI CON MOSCHETTONE O CLIP

In PVC trasparente. Versione con moschettone in acciaio o con molle di fissaggio. **Minimo ordinabile 5 pezzi/multipli.**

4 BUSTA5MOB - busta portadocumenti con moschettone formato A5 orizzontale - mm 120 x 230 (h x l)

5 BUSTA5FOB - busta portadocumenti con molle di fissaggio formato A5 orizzontale - mm 120 x 230 (h x l)



BAULI IN ALLUMINIO

Costruiti in lamiera mandorlata di alluminio da mm 2 più mandorla, sono leggeri impermeabili, resistenti all'urto e accatastabili. Ideale per contenere gli attrezzi di lavoro su mezzi di trasporto o in ambienti lavorativi. Dotate di 2 maniglie e di 2 serrature (2 chiavi incluse nella fornitura). A richiesta kit ruote portata kg 150.

6 HSB50 - baule in lamiera mandorlata di alluminio, dimensioni mm 1420 x 530 x 500 (l x h x p), peso kg 24

7 HSB30 - baule in lamiera mandorlata di alluminio, dimensioni mm 820 x 330 x 300 (l x h x p), peso kg 8,70

8 HSB40 - baule in lamiera mandorlata di alluminio, dimensioni mm 1220 x 430 x 400 (l x h x p), peso kg 15,40

9 HSBR - ruota Ø 100 mm fornita con vite M12 opzionale (necessari 4 pezzi per portata kg 90)



10 BUSTE DI SICUREZZA IN POLIETILENE

In polietilene coestruso. Coupon di controllo con funzione di ricevuta, codice a barre per la lettura a mezzo scanner. Striscia VOID per una maggior sicurezza antimanomissione. Indicate **per contenere valori, assegni, contante, documenti, buoni pasto e altro materiale che si vuole proteggere.** Colore bianco, interno opaco (contenuto non visibile). **Minimo ordinabile 500 pezzi.**

BUS1110 - buste di sicurezza numerate mm 120 x 195

BUS1120 - buste di sicurezza numerate mm 200 x 290

BUS1130 - buste di sicurezza numerate mm 270 x 420



11 BAULE PORTA ATTREZZI

Baule porta attrezzi professionale in polipropilene. Chiusura di sicurezza con chiave. Maniglie in metallo zincato. Tenuta d'acqua.

TPU100 - baule 100 x 52 x 51 cm, peso 10,3 kg

TPU080 - baule 80 x 50 x 47 cm, peso 8 kg

TPU080R - baule con ruote e maniglia 81 x 50 x 51 cm, peso 10 kg



Contenitori multiuso sovrapponibili

Contenitori in polipropilene, ultra robusti, in materiale antiurto **inattaccabile da acidi e solventi**, pareti piene, maniglie chiuse. Adatti per gli alimenti, **certificati "MOCA" (materiali/oggetti destinati al contatto con gli alimenti e con l'acqua)**, riciclabili, dimensioni unificate europee. Colore grigio. Altre dimensioni fornibili a richiesta. Coperchi a slitta x contenitori mm 300 x 200 e a slitta o con cerniere integrate x contenitori mm 600 x 400 e 400 x 300, fornibili a richiesta.

- 1 CPLC260** - contenitore, dimensioni esterne mm 300 x 200 x 140 h, *fondo pieno*
- 2 CPLC261** - contenitore, dimensioni esterne mm 300 x 200 x 90 h, *fondo pieno*
- 3 CPLC262** - contenitore, dimensioni esterne mm 400 x 300 x 70 h, *fondo pieno*
- 4 CPLC263** - contenitore, dimensioni esterne mm 400 x 300 x 220 h, *fondo alveolare*
- 5 CPLC264** - contenitore, dimensioni esterne mm 600 x 400 x 170 h, *fondo alveolare*
- 6 CPLC265** - contenitore, dimensioni esterne mm 600 x 400 x 220 h, *fondo alveolare*



FONDO ALVEOLARE (NON È FORATO): CARATTERISTICA COSTRUTTIVA CHE RENDE IL FONDO E QUINDI IL CONTENITORE INDEFORMABILE E RESISTENTE.

FONDO PIENO: ADATTO PER I MODELLI PIÙ PICCOLI

7 CARRELLO ACCESSORIO PER CONTENITORI MULTIUSO

CPLC268 - carrello 4 ruote, dimensioni 620 x 420 x 170 mm. Utilizzabile con 4 contenitori 300 x 200 mm, 2 contenitori 400 x 300 mm o 1 contenitore 600 x 400 mm.

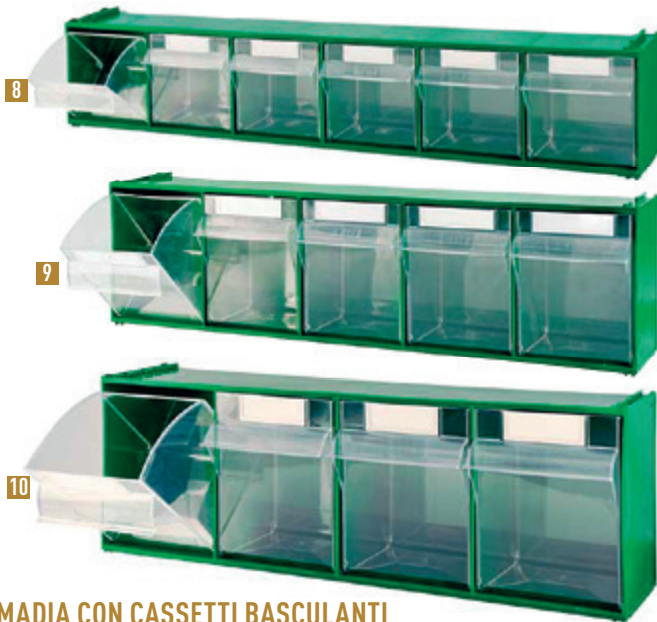

MADIA CON CASSETTI BASCULANTI

Realizzati in materiale riciclabile PST, struttura colore verde cassetti basculanti trasparenti. Fornibili in 3 modelli (con 6, 5 o 4 cassette).

DIMENSIONI MADIE CON CASSETTI BASCULANTI (mm)

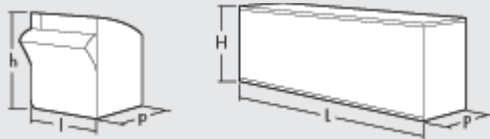

CODICE	l	h	p	L	H	P	N° CASSETTI
8 CPLC600	88	98/70	65	600	112	96	6
9 CPLC601	108	148/107	98	600	168	140	5
10 CPLC602	138	190/134	127	600	206	178	4



TELAJ PER CASSETTI BASCULANTI

Pratiche e robuste strutture realizzate in lamiera elettrosaldata e verniciate a forno con polvere epossidica, ideate per l'utilizzo con madie da 6, 5 o 4 cassette che si incastrano all'interno della struttura stessa. Disponibili in 3 formati per diversi utilizzi.

- 11 CPLC195** - modello a pavimento con base, 600 x 205 x 1950 mm (l x p x h) (utile 1850), fornito smontato con viteria per assemblaggio
- 12 CPLC196** - modello a parete, 600 x 40 x 1000 mm (l x p x h)
- 13 CPLC197** - modello da banco, 610 x 150 x 500 mm (l x p x h)



PALLET E CONTENITORI MULTIUSO



PALLET

Realizzati in polietilene, impilabili, riciclabili, con tara costante e superficie antisdruciuolo. Dimensioni unificate Europee. Forniti in diversi modelli impilabili o con travette, in funzione del carico che devono trasportare. Colore nero.

- 1 **CPLP610** - pallet impilabili 800 x 1200 x 135 h, **capacità statica 1500 kg**, capacità dinamica 600 kg
- 2 **CPLP611** - pallet con travette 800 x 1200 x 160 h, **capacità statica 1500 kg**, capacità dinamica 600 kg
- 3 **CPLP612** - pallet impilabili 600 x 800 x 140 h, **capacità statica 3000 kg**, capacità dinamica 600 kg
- 4 **CPLP613** - pallet impilabili 800 x 1200 x 140 h, **capacità statica 4000 kg**, capacità dinamica 1200 kg
- 5 **CPLP614** - pallet con travette 800 x 1200 x 150 h, **capacità statica 4000 kg**, capacità dinamica 1000 kg



CONTENITORI MULTIUSO A BOCCA DI LUPO

Contenitori multicomponibili autoportanti, in polipropilene, riciclabili a bocca di lupo, ideali per il prelievo manuale del contenuto nei magazzini e nelle catene di montaggio.

- 5 **CPLC240G** - contenitore colore verde, dimensioni esterne 144 x 235 x 116 h, adatto per gli alimenti
- 6 **CPLC241S** - contenitore colore grigio, dimensioni esterne 307 x 480 x 185 h
- 7 **CPLC242S** - contenitore colore grigio, due scomparti, dimensioni esterne 307 x 480 x 185 h
- 8 **CPLC243S** - contenitore colore grigio, dimensioni esterne 437 x 570 x 247 h

FORNIBILI
A RICHIESTA
DIMENSIONI E
COLORAZIONI
DIVERSE!



CONTENITORI MULTIUSO SOVRAPPONIBILI E IMPILABILI

Adatti alla movimentazione e allo stoccaggio. Resistenti a temperature tra -10°C e 100°C. Fornibili in due versioni: con alette e senza. Le alette consentono di sovrapporre o impilare a seconda di come vengono utilizzate. Coperchi e sistemi di chiusura fornibili a richiesta. Colore grigio.

- 9 **CPLC270** - contenitore, dimensioni 600 x 400 x 410 h, senza alette
- 10 **CPLC271** - contenitore, dimensioni 600 x 400 x 410 h, con alette
- 11 **CPLC272** - contenitore, dimensioni 800 x 400 x 410 h, senza alette
- 12 **CPLC273** - contenitore, dimensioni 800 x 400 x 410 h, con alette

13 CARRELLO ACCESSORIO PER CONTENITORI

- CPLC278** - carrello 4 ruote per contenitori multiuso, dimensioni 600 x 400 mm
- CPLC279** - carrello 4 ruote per contenitori multiuso, dimensioni 800 x 400 mm





Cargopallet

Resistenti, indeformabili, progettati per carichi rilevanti, hanno colonne di rinforzo, fondo nervato e sono inerti a contatto di acidi, idrocarburi e solventi. Realizzati in polietilene alta densità e polipropilene riciclato, hanno dimensioni unificate europee, sono impilabili e forniti in diverse tipologie e dimensioni. Colore grigio.



1



1

MODELLO
CON TRAVETTE
ANTIRIBALTAMENTO

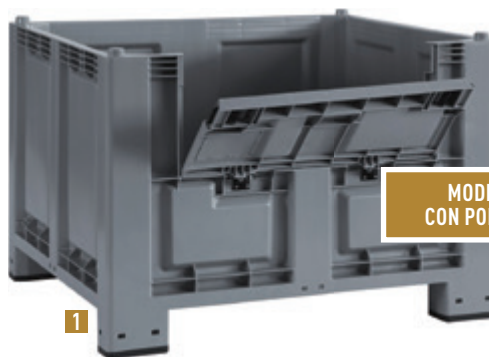

1

MODELLO
CON PORTELLO



2



3



A



B

1 CARGOPALLET MODELLO 600

Dimensioni esterne 1200 x 800 x 850 h, capacità 550 dm³, portata 500 kg.

- CPL4551** - cargopallet modello 600 con 4 **piedi (A)**
- CPL4552** - cargopallet modello 600 con **portello**, 4 **piedi (A)**
- CPL4553** - cargopallet modello 600 con **portello, foro** e 4 **piedi (A)**
- CPL4554** - cargopallet modello 600 con **portello**, con **ruote (B)**
- CPL4555** - cargopallet modello 600 con **portello, ruote, foro**, 4 **piedi (A)**
- CPL4637** - coperchio per cargopallet modello 600

ACCESSORI PER CARGOPALLET

- 2 CPL6001** - rubinetto a sfera per modelli con foro
- 3 CPL6002** - tappo a vite in resina per modelli con foro

1 CARGOPALLET MODELLO 300

Dimensioni esterne 1000 x 700 x 650 h, capacità 297 dm³, portata 300 kg.

- CPL4180** - cargopallet modello 300 con 4 **piedi (A)**
- CPL4181** - cargopallet modello 300 con 4 **piedi (A)** più 2 **travette anti-ribaltamento**

1 CARGOPALLET MODELLO 700

Dimensioni esterne 1200 x 1000 x 830 h, capacità 680 dm³, portata 600 kg.

- CPL4821** - cargopallet modello 700 con 4 **piedi (A)**
- CPL4822** - cargopallet modello 700 con 4 **piedi (A)** più 2 **travette anti-ribaltamento**
- CPL4831** - cargopallet modello 700 con portello, 4 **piedi (A)**

Cargopallet omologato per prodotti pericolosi solidi

Versione omologata per il trasporto terrestre e ferroviario e per lo stoccaggio di prodotti pericolosi solidi appartenenti al gruppo d'imballaggio III (UN 3077) della normativa ADR. Costruito in HDPE inattaccabile da acidi, grassi e solventi. Colore grigio RAL 7001. Dotato di etichetta identificativa riportante le 4 normative UNI riferite alla tipologia di batterie che possono essere stoccate: UN2794, UN2795, UN2800, UN3028. Munito di 2 travette sul lato lungo, è versatile e robusto, ha un'ottima rigidità strutturale e resiste alle deformazioni. Stoccabile all'aperto sovrapponibile ed inforcabile. L'omologazione è valida se il contenitore durante il trasporto è munito di coperchio e reggiato.

4 CARGOPALLET MODELLO 300

Dimensioni esterne 1000 x 700 x 650 h, capacità 297 dm³.

- CPST162** - cargopallet con 4 **piedi** più 2 **travette anti-ribaltamento** per prodotti pericolosi solidi, portata 300 kg
- CPST163** - coperchio per cargopallet modello 300

4 CARGOPALLET MODELLO 600

Dimensioni esterne 1200 x 800 x 850 h, capacità 550 dm³.

- CPST743** - cargopallet con 4 **piedi** più 2 **travette anti-ribaltamento** per prodotti pericolosi solidi, portata 500 kg
- CPST744** - coperchio per cargopallet modello 600



4



Contenitori in lamiera per magazzini

Gestiscono in modo razionale la movimentazione e lo stoccaggio di grandi volumi di merci. Disponibili in diversi modelli per tutte le necessità.

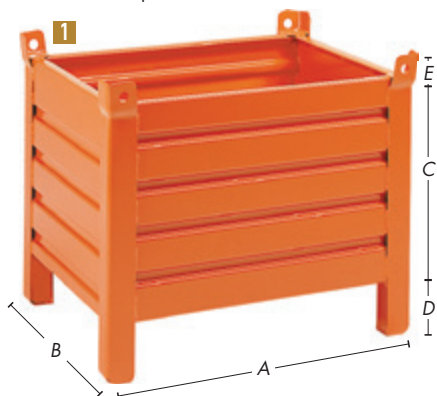

1 IN LAMIERA CON PIEDE SCATOLATO

- CPLS10A** - contenitore portata 600 kg
- CPLS11A** - contenitore portata 800 kg
- CPLS12A** - contenitore portata 800 kg

DIMENSIONI (mm)

	A	B	C	D	E
CPLS10A	800	600	410	130	65
CPLS11A	1000	800	650	130	65
CPLS12A	1200	800	650	130	65

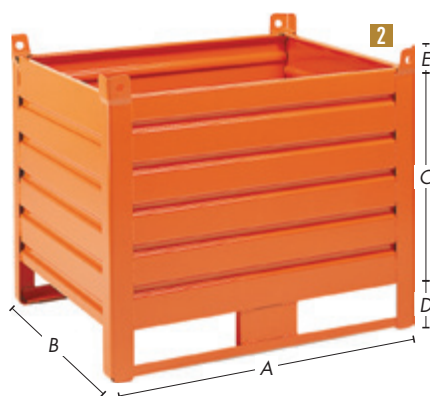

2 IN LAMIERA CON SLITTA

- CPLS20A** - contenitore portata 1000 kg
- CPLS21A** - contenitore portata 1000 kg
- CPLS22A** - contenitore portata 2000 kg

DIMENSIONI (mm)

	A	B	C	D	E
CPLS20A	1000	800	650	130	65
CPLS21A	1200	800	650	130	65
CPLS22A	1000	800	650	150	110



3 CONTAINER STANDARD IN RETE

Contenitore in acciaio a rete per magazzini con 4 pareti e 4 ruote per una facile movimentazione. Dimensioni esterne mm 715 x 805 x 1600 h, dimensioni interne mm 655 x 745 x 1440 h. Finitura: zincatura elettrolitica brillante. Portata kg 31,5. Maglia della base mm 44 x 180. Maglia delle pareti mm 106 x 405.

CPLS60 - container standard a rete in acciaio con ruote

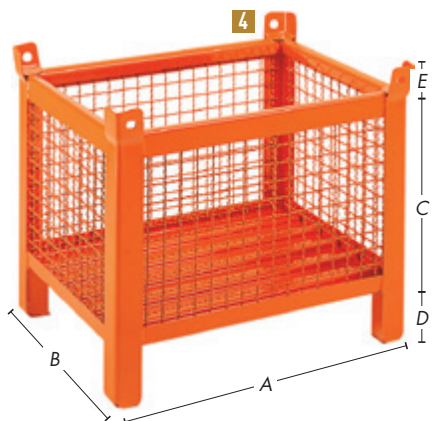

4 IN RETE CON PIEDE SCATOLATO

- CPLS30A** - contenitore portata 500 kg
- CPLS31A** - contenitore portata 800 kg

DIMENSIONI (mm)

	A	B	C	D	E
CPLS30A	800	500	500	130	65
CPLS31A	1000	800	650	130	65

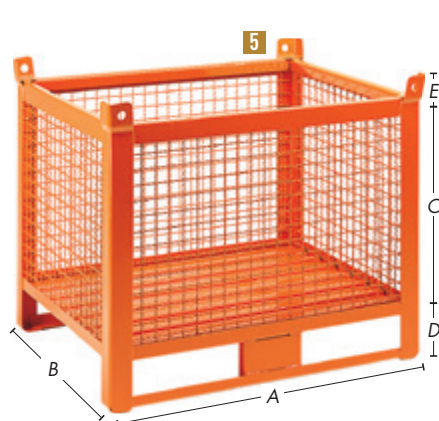

5 IN RETE CON SLITTA

- CPLS40A** - contenitore portata 1000 kg
- CPLS41A** - contenitore portata 1000 kg

DIMENSIONI (mm)

	A	B	C	D	E
CPLS40A	1000	800	650	130	65
CPLS41A	1200	800	650	130	65



6 IN RETE CON SLITTA E PORTA

- CPLS50A** - contenitore portata 1000 kg
- CPLS51A** - contenitore portata 1000 kg

DIMENSIONI (mm)

	A	B	C	D	E
CPLS50A	1000	800	650	130	65
CPLS51A	1200	800	650	130	65

FORNIBILI A RICHIESTA SOLUZIONI DIVERSE (COLORI, MISURE, PORTATA, ACCESSORI A CORREDO). RICHIEDI UN PREVENTIVO!



ALTRE TIPOLOGIE DI CONTENITORI A PAGINA 497.



1 FONDINA PER TRAPANI A BATTERIA

Con asola per cintura TPU530 in tessuto speciale rinforzato.

TPU531 - fondina per trapani, dimensioni 17 x 21 x 33,5 cm



2 TASCA PORTA PINZA

In tessuto speciale rinforzato, con clip metallica, adatta ad ogni cintura.

TPU524 - tasca porta pinza, dimensioni 11,5 x 23 x 28 cm



3 PORTA TELEFONO

In tessuto speciale imbottito, con clip metallica.

TPU539 - porta telefono, dimensioni esterne 8 x 4 x 15 cm



4 TASCA PORTASMARTPHONE

Tasca porta smartphone (Galaxy S4/S5 o dimensioni simili) con clip metallica. Resistente all'acqua.

TPU549 - tasca porta smartphone, dimensioni esterne 16 x 10 x 3 cm

CON CLIP METALLICA!



5 MARSUPIO PORTAUTENSILI

Marsupio con cintura regolabile. Apertura a ribalta con tasca.

TPU545 - marsupio portautensili, dimensioni 34 x 31 x 33 cm



6 ASTUCCIO PORTAUTENSILI

Astuccio portautensili con tasca interna, appendibile a muro.

TPU558 - astuccio portautensili, dimensioni 21,5 x 26 x 37 cm



7 TASCA PORTAUTENSILI

In tessuto speciale rinforzato, tasca interna imbottita, 2 tasche con cerniera, maniglia e tracolla.

TPU556 - tasca portautensili, dimensioni 20,5 x 17,5 x 25 cm



8 CINTURA DA CARPENTIERE

In tessuto speciale rinforzato, tasca frontale per chiodi, porta martello e porta metro in metallo. Chiusure in metallo.

TPU546 - cintura da carpentiere, dimensioni 36 x 18 x 26,5 cm



9 TASCA PORTAUTENSILI

In tessuto speciale rinforzato, con moschettone in plastica per aggancio a cintura.

TPU534 - tasca portautensili, dimensioni 31 x 28 x 35 cm



10 TASCA PER ELETTRICISTI

In tessuto speciale rinforzato, con tasche, asola elastica e catena porta nastro adesivo.

TPU535 - tasca per elettricisti, dimensioni 21 x 25 x 29,5 cm



11 ZAINO IMBOTTITO

Imbottito, rinforzato posteriormente, con cinghie regolabili e doppio fondo.

TPU542 - zaino, dimensioni 36 x 37,5 x 42 cm



12 CINTURA PORTA UTENSILI

In tessuto rinforzato, regolabile da 90 a 120 cm.

TPU530 - cintura a sganciamento rapido



IMBRACATURA E CORDINO PER SCANNER

Prevedono le cadute accidentali dello scanner. Il collegamento avviene tramite piccoli fori presenti nello scanner. Adatti alla maggior parte degli scanner standard attualmente in commercio. Cinghie e fibbie facilmente regolabili per adattarsi alle diverse corporature dei lavoratori.

13 EDS3132. - imbracatura per scanner, taglia S o L

14 EDS3134 - cordino per imbracatura, taglia unica



LIVELLO DI SICUREZZA MASSIMO

> TAGLIERINI CON LAMA NASCOSTA PER MASSIMO GRADO DI SICUREZZA E PROTEZIONE DEI BENI IMBALLATI.



LIVELLO DI SICUREZZA ELEVATO

> TAGLIERINI CON LAMA RETRATTILE AUTOMATICAMENTE. LA LAMA RIENTRA NON APPENA PERDE IL CONTATTO CON IL MATERIALE ANCHE SE SI TIENE PREMUTO IL NOTTOLINO.



LIVELLO DI SICUREZZA BASE

> TAGLIERINI CON LAMA RETRATTILE AUTOMATICAMENTE. LA LAMA RIENTRA NON APPENA PERDE IL CONTATTO CON IL MATERIALE SOLO SE NON SI TIENE PREMUTO IL NOTTOLINO.

1 SECUMAX 320



Corpo in vetroresina, per uso destrorso e sinistrorso. **Adatto per tagliare pellicole avvolgibili, estensibili e termoretraibili, fogli di pellicola e carta, reggette di plastica, cartone fino a 1 strato, nastri adesivi, merce in sacchi, tessuto, feltro, cinture di sicurezza, cuoio, pellicole rivestite di stagnola e laminate.** Incisore regolabile a 2 profondità di taglio (5 e 3,5 mm).

MTS3200 - Secumax 320, profondità di taglio 5 - 3,5 mm, lunghezza totale 158 mm

MTS2043 - confezione 10 lame di ricambio



2 SECUMAX 350



Corpo in plastica, leggerissimo (solo 37 g). Per uso destrorso e sinistrorso. Lama con due bordi arrotondati per incidere nastri di imballaggi. **Adatto per tagliare cartone fino a 2 strati, pellicole, nastri adesivi e reggette di plastica.** Fornito con lama supplementare di ricambio.

MTS7081 - profondità di taglio 6 mm, lunghezza totale 154 mm

MTS7082 - confezione 10 lame di ricambio



3 SECUMAX EASYSAFE



Corpo in plastica, per uso destrorso e sinistrorso. **Adatto per il taglio di pellicole, reggette di plastica, sacchi e rotoli di carta.** Piastrina metallica per taglio nastri adesivi, guida in plastica per tagliare singolarmente fogli di carta. Possibilità di bloccare il taglierino per impedire accessi non autorizzati (es. cambio lama) con utensile fornito a richiesta.

MTS5329 - profondità di taglio 7 mm, lunghezza totale 205 mm

MTS4560 - confezione 10 lame di ricambio



4 SECUMAX 150



Corpo in plastica leggero (solo 24 g), per uso destrorso e sinistrorso. **Adatto per tagliare, raschiare e dividere cartoni a onda doppia, pellicole, nastri adesivi, prodotti insaccati, rotoli di carta e stagnola.** La parte superiore della lama ne consente l'utilizzo come raschietto, larghezza lama 21 mm. Modello a lama fissa non sostituibile.

MTS7071 - Secumax 150, lunghezza totale 150 mm



5 SECUMAX 564



Realizzate in acciaio inox con impugnatura in vetroresina, ergonomiche, presa morbida. Le lame levigate perpendicolarmente rendono queste forbici estremamente taglienti ma assolutamente innocue per chi le utilizza. Per uso destrorso e sinistrorso. **Adatte per tagliare cartone fino a 2 strati, reggette di plastica, pellicola termoretraibile, tessuti, filati e PVC.**

MTS5641 - forbici, lunghezza taglio 80 mm, lunghezza forbici 218 mm, peso 93 g

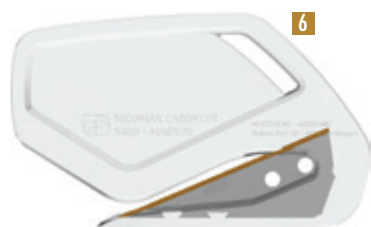

6 CARDY CUT 5469



Corpo in plastica trasparente, per uso destrorso e sinistrorso. **Ideale per tagli curvi e in spazi particolarmente stretti.** Lama in acciaio inossidabile nascosta a persone e oggetti per prevenire incidenti e danni ai prodotti. Profondità di taglio della lama: 2 mm.

MTS5469 - Secumax Cardycut, lunghezza totale 71 mm



7 MARSUPI

Sviluppati per i taglierini ma non solo; in base alla dimensione si possono combinare: coltello/penna, coltello/forbici, ecc. In nylon, resistenti e lavabili, cuciture doppie, con clip e velcro per fissaggio a cintura o tasche pantaloni.

MTS9920 - marsupio mm 215 x 53 x 23 per 1 taglierino

MTS9922 - marsupio mm 215 x 68 x 40 per 2/3 taglierini



1 SECUPRO MAXISAFE

TESTED FOR SAFETY

Corpo in vetroresina rinforzato in plastica. Parte frontale in metallo che riduce attriti e resiste a forti sollecitazioni. Per uso destrorso e sinistrorso. **Adatto per tagliare cartone fino a 3 strati, reggette di plastica, nastri adesivi, carta, pellicole avvolgibili, estensibili e termoretraibili, filato, cordone, feltro, tessuto non tessuto, merce in sacchi, tessuto.**

MTS9910 - profondità di taglio 17,2 mm, lunghezza totale 148 mm
MTS9950 - confezione 10 lame di ricambio



2 SECUPRO MERAK

TESTED FOR SAFETY

Corpo in plastica, con leva, per uso destrorso e sinistrorso. Dispositivo di blocco della lama che impedisce fuoriuscite accidentali. **Adatto per tagliare cartone fino a 2 strati, reggette di plastica, nastri adesivi ed estrarre materiali imballati in rotoli.**

MTS7025 - profondità di taglio 9 mm, lunghezza totale 128 mm
MTS7021 - confezione 10 lame di ricambio



3 SECUPRO 625

TESTED FOR SAFETY

Corpo in alluminio, per uso destrorso e sinistrorso. **Adatto per tagliare cartoni ad onda tripla, reggette di plastica, sacchi, gomma, pvc, cuoio, tappeti, tessuti, nastri adesivi, feltro.** Fuoriuscita lama 24 mm.

MTS7072 - profondità di taglio 21 mm, lunghezza totale 154 mm
MTS7075 - confezione 10 lame di ricambio

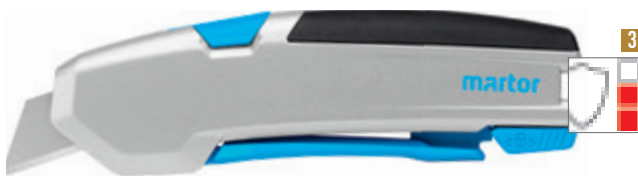

4 SECUNORM 500

TESTED FOR SAFETY

Corpo in alluminio, cambio lama sicuro (grazie al magnete), resistenza massima all'abrasione. Per uso destrorso e sinistrorso, estremamente ergonomico garantisce una migliore maneggevolezza. Nuova slitta può essere utilizzata in modo flessibile da entrambi i lati. **Per tagliare cartone fino a 3 strati, pellicole avvolgibili, estensibili e termoretraibili, reggette di plastica, nastri adesivi, merce in sacchi, carta, filato, cordone, tessuto, feltro, tessuto non tessuto.**

MTS0110 - profondità di taglio 17 mm, lunghezza totale 143 mm
MTS6523 - confezione 10 lame di ricambio



5 SECUNORM MIZAR

TESTED FOR SAFETY

Corpo in resina sintetica, per uso destrorso e sinistrorso. Con cursore "3 in 1" per sbloccare la lama per il taglio, riporta all'interno del corpo durante gli spostamenti e consentirne la sostituzione. **Adatto per tagliare cartoni a onda tripla, pellicole, nastri adesivi e reggette di plastica.** Fuoriuscita lama 22 mm.

MTS7017 - profondità di taglio 15 mm, lunghezza totale 140 mm
MTS5232 - confezione 10 lame di ricambio



6 SECUNORM 540

TESTED FOR SAFETY

Corpo in alluminio. Per uso destrorso e sinistrorso. **Adatto per tagliare materiale espanso, polistirolo, nastri di carta e sacchi.**

MTS0540 - profondità di taglio 36 mm, lunghezza totale 143 mm
MTS7940 - confezione 10 lame di ricambio



7 SECUNORM 380

TESTED FOR SAFETY

Per uso destrorso e sinistrorso. Lama flessibile per effettuare tagli con estrema sicurezza. Adatto per tagliare cartoni fino a 4 strati e blocchi di schiuma spessa, aprire sacchi, dividere fogli di carta, pellicole, nastri adesivi, reggette di plastica, PVC, ecc.

MTS7023 - profondità di taglio 73 mm, lunghezza totale 171 mm
MTS7024 - confezione 10 lame di ricambio



8 SECUNORM SMARTCUT

TESTED FOR SAFETY

Corpo in plastica. Per uso destrorso e sinistrorso. **Adatto per tagliare cartoni a onda doppia, pellicole, fogli di carta.** Fuoriuscita lama 14 mm (non sostituibile).

MTS2110 - profondità di taglio 12 mm, lunghezza totale 110 mm



9 SECUNORM 175

TESTED FOR SAFETY

Corpo in vetroresina, modello ergonomico ed economico. Cambio lama semplice, per uso destrorso e sinistrorso. **Adatto per tagliare cartone fino a 2 strati, reggette di plastica, pellicola termoretraibile, nastro adesivo, filato e cordone.**

MTS0175 - profondità di taglio 10 mm, lunghezza totale 110 mm
MTS4560 - confezione 10 lame di ricambio





SIGILLI DI SICUREZZA



SIGILLI DI SICUREZZA IN PLASTICA CON BLOCCAGGIO METALLICO A CODA ROTONDA

Sigilli di sicurezza in polipropilene regolabili. Applicazione veloce e sicura, meccanismo di chiusura con bloccaggio metallico. Il sigillo viene prodotto in strip uniti da 10 pezzi numerati progressivamente. Adatti per molteplici applicazioni, come la chiusura di qualsiasi mezzo di trasporto, telonati, cisterne e container. Personalizzabili con numerazione consequenziale fino a 15 cifre e codice a barre (minimo ordinabile 5000 pezzi oppure 1000 con un contributo spese).

- 1 **SGE1130**. - confezione 1000 sigilli Ø 2 mm, lunghezza totale mm 315, etichetta mm 22x50. **Colori:** W bianco B blu Y giallo G verde R rosso
- 2 **SGE1128**. - confezione 1000 sigilli Ø 3,3 mm, lunghezza totale mm 425, etichetta mm 22x50. **Colori:** W bianco B blu Y giallo G verde R rosso
- 3 **SGE1131**. - confezione 1000 sigilli Ø 2 mm, lunghezza utile mm 375, lunghezza totale mm 425. **Colori:** W bianco Y giallo

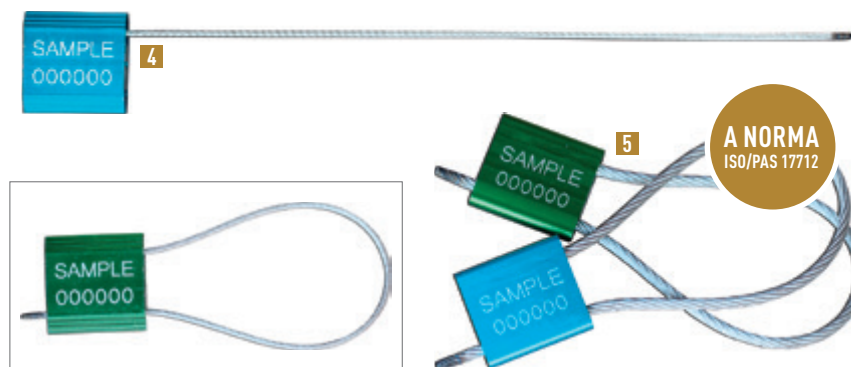

A NORMA
ISO/PAS 17712

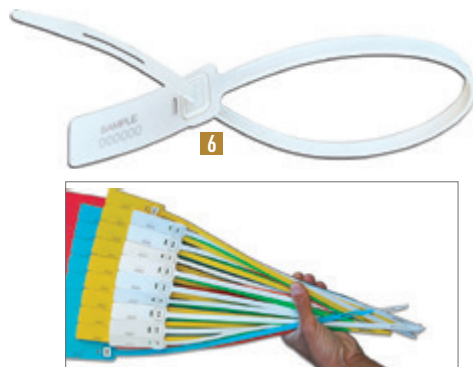

SIGILLI DI SICUREZZA CON CAVO IN ACCIAIO

Sigilli a cavo di alta sicurezza versatili e regolabili. Il sigillo a cavo da 3,5 mm e 1,5 mm di diametro ha il corpo in alluminio anodizzato da cui fuoriesce il cavo in acciaio. Una volta inserita l'estremità libera del cavo nell'apposito foro sul corpo del sigillo, non vi sarà più modo di aprirlo se non tagliandolo con una tronchese. Forniti con numerazione progressiva e personalizzabili a 15 cifre, logo e codice a barre con un contributo spese.

Colori: C celeste G verde

- 4 **SGE2204**. - confezione da 500 sigilli, Ø mm 1,5, lunghezza mm 300
- 5 **SGE2203**. - confezione da 500 sigilli, Ø mm 3,5, lunghezza mm 250. **Certificati ISO 17712:2013**

6 SIGILLI DI SICUREZZA PIATTI IN PLASTICA CON BLOCCAGGIO METALLICO A CODA PIATTA

Robusti, realizzati in polipropilene copolimero, meccanismo di chiusura con bloccaggio metallico. Il sigillo si presenta in strip uniti da 10 pezzi numerati progressivamente. Questi sigilli possono essere usati per sigillare qualsiasi mezzo di trasporto o per chiudere sacchi e big bag. Personalizzabili con numerazione consequenziale fino a 15 cifre o codice a barre (minimo ordinabile 5000 pezzi oppure 1000 con un contributo spese).

Colori: W bianco C celeste Y giallo R rosso

- SGE1122**. - confezione da 1000 sigilli, larghezza 7,5 mm, lunghezza totale mm 430, etichetta mm 30 x 83

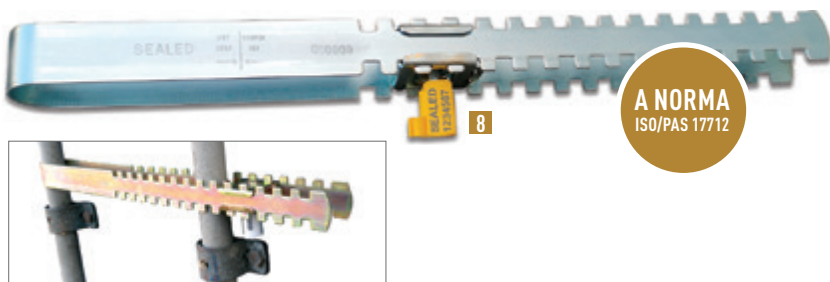
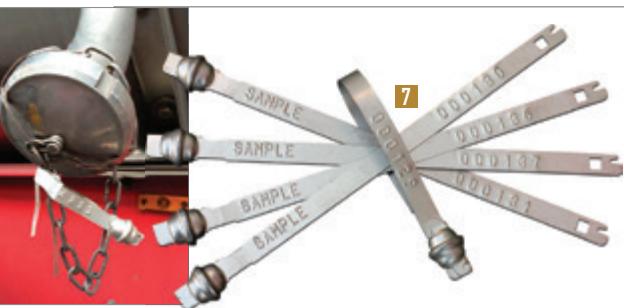

A NORMA
ISO/PAS 17712

7 SIGILLI DI SICUREZZA A FASCETTA IN METALLO

Sigilli di sicurezza a fascetta in metallo, autobloccanti. Chiusura automatica con doppia molla nella testa del sigillo, una volta scattata non vi è più possibilità di apertura. Particolarmente indicati per i trasporti in genere, su camion e su container. Realizzati in acciaio stagnato vengono forniti con numerazione progressiva.

- SGE2302** - confezione da 1000 sigilli in metallo, lunghezza mm 215, larghezza mm 9,5

8 SIGILLI DI ALTA SICUREZZA A BARRA PER CONTAINER

Sigilli di alta sicurezza a barra per container certificati ISO 17712:2013. Adatti per evitare aperture anche minime della porta dei container, è opportuno bloccare le due barre centrali quanto più strette possibile. Sia forcilla che sigillo sono in acciaio galvanizzato ed hanno la stessa numerazione e personalizzazione, rendendo impossibile la contraffazione.

- SGE2100** - confezione da 25 sigilli, larghezza mm 35 lunghezza mm 480

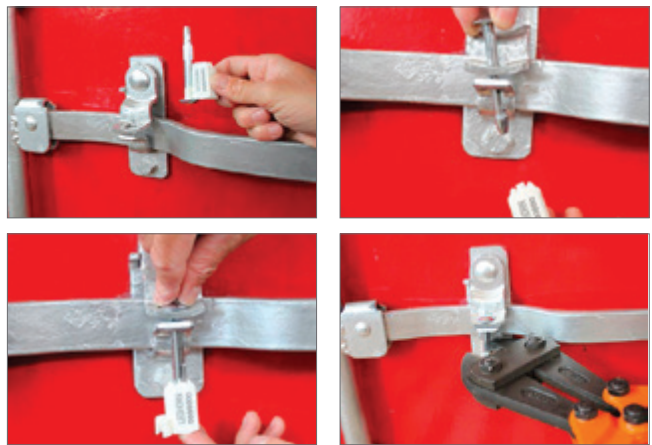

1 SIGILLI DI ALTA SICUREZZA A CHIUDO PER CONTAINER

Sigilli di alta sicurezza a chiodo colore giallo per container certificati ISO 17712:2013. Adatti per tutti i tipi di container marittimi, inclusi quelli con la chiusura al piede del container. Impossibile la manomissione attraverso la rotazione velocissima del barilotto. Per aprire il sigillo munirsi di apposite tronchesi a braccio lungo. Chiodo e barilotto hanno la stessa numerazione e possono essere personalizzati con codice a barre o Data Matrix (con contributo spese).

SGE3103Y - sigilli a chiodo per container (minimo ordinabile 50 pezzi/multipli)



2 SIGILLI DI SICUREZZA IN PLASTICA A FILO

Sigilli di sicurezza in plastica con cavetto incorporato. Parte esterna prodotta in policarbonato trasparente per controllo meccanismo di chiusura. Particolarmente adatti per le chiusure difficili e dove il foro di chiusura ha dimensioni molto ridotte anche inferiori a 2 mm, come contatori acqua, luce, gas e bottiglie per campionamento. Una volta chiusi questi sigilli non si possono manomettere. Forniti con numerazione consecutiva.

SGE3301 - confezione da 1000 sigilli colore rosso



3 ETICHETTE DI SICUREZZA BAG SAFE PLUS

Le etichette di sicurezza proteggono contro la rimozione non autorizzata. Possono essere applicate su superfici lisce e ruvide. Speciale caratteristica tecnica di rilascio permanente del messaggio "VOID" sul retro dell'etichetta qualora si effettui il tentativo di rimuoverla dalla superficie a cui è stata applicata. Inoltre l'etichetta include un chip ed un'antenna RFID UHF, consentendo così anche funzioni di identificazione automatica univoca (per letture senza contatto e non in linea di vista). Fornite con numerazione progressiva e ampia possibilità di personalizzazione (minimo 1000 pezzi).

SGE1221C - confezione da 1000 etichette colore celeste, dimensioni mm 90 x 35



4 BUSTE DI SICUREZZA PER DOCUMENTI

PAC SAFE PLUS (VOID): Buste di sicurezza con numerazione e nastro Void. Prodotte in polietilene coestruso, con numerazione unica e irripetibile, sono munite di coupon staccabile con funzione di ricevuta e codice a barre per lettura a mezzo scanner. La banda adesiva Void garantisce la massima sicurezza antimanomissione. Adatte per contenere valori, contanti, assegni, documenti o altro materiale che si vuole proteggere. **Minimo ordinabile 1.000 buste**. Colore bianco, spessore 70 micron.

BUS1111 - busta dimensioni mm 125 x 195

BUS1120 - busta dimensioni mm 200 x 290

BUS1131 - busta dimensioni mm 270 x 420



SIGILLI IN PIOMBO, PINZA, SPIRALINA E SIGILLI A CLIP

I sigilli in piombo si applicano sulla spirulina e si chiudono con la pinza. **I sigilli a clip** sono in alluminio (a richiesta metallo lucido), autobloccanti, da utilizzare con spiruline di ogni tipo, cavetti d'acciaio, fili di nylon, spago. Si chiudono con semplice pressione delle dita. Incisione a rilievo e numerazione consequenziale fino a 6 cifre. Per ordini speciali: personalizzazione fino a 10 caratteri su una riga e con proprio logo. La spirulina è indicata per chiudere i contatori con fori inferiori a mm 2.

5 SGE1602 - confezione da 10 kg di sigilli in piombo Ø mm 11 (misura doganale)

6 SGE2502 - confezione da 10.000 sigilli a clip mm 57 x 33 x 30, peso 7 kg

7 SGE4304 - spirulina zincata rotolo da 400 metri, peso 1 kg

8 SGE1698 - pinza in lamiera di ferro con punzone personalizzabile a caratteri (compreso) su un lato, manici in plastica, per sigilli fino a Ø mm 12



1 PAINT-RITER® VALVE ACTION PAINT MARKER

Pennarello a vernice permanente, misura marcatura 2-4 mm. Marca su qualsiasi superficie pulita (metallo, ceramica, vetro, legno ecc). Vernice opaca, coprente, visibile, resistente all'acqua e agli UV, ideale nel controllo qualità industria automobilistica. Resiste a temperature superiori a 70°C. Temperatura di applicazione: -46°C + 66°C. Minimo ordinabile 12 pezzi/multipli. Colori: **W** bianco **Y** giallo **R** rosso **N** nero

MAK240. - pennarello a vernice permanente Valve Action®



1



2 PAINT-RITER®+ OILY SURFACE

Pennarello a vernice permanente a forte aderenza, misura marcatura 2-4 mm. Marca su qualsiasi tipo di superficie pulita (metallo, ceramica, vetro, legno ecc) oppure grasse ed oleose, resistente all'acqua e agli UV. Resiste a temperature superiori a 70°C. Temperatura di applicazione: -46°C + 66°C. Minimo ordinabile 12 pezzi/multipli.

Colori: **W** bianco **N** nero **Y** giallo **R** rosso.

MAK969. - pennarello a vernice permanente Paint-Riter®+ Oily Surface



2



DURA INK® FINE, CHISEL E BULLET

Indelebile, con punta extra solida che evita le sbavature. Inchiostro resistente all'acqua ad asciugatura rapida, formulato per uso industriale. Idoneo su cartone, ceramica, stoffa, legno, carta, gomma e acciaio. Minimo ordinabile 12 pezzi/multipli. Colori: **R** rosso **N** nero.

3 MAK960. - punta fine mm 2

4 MAK965. - punta a scalpello mm 2-5

5 MAK966. - punta tonda mm 4



3

4

5



6 DURA INK® RETRACTABLE 20

Indelebile senza tappo, fuoriuscita della punta con pulsante a scatto. Resiste all'acqua, si asciuga rapidamente. Inchiostro formulato per uso industriale, idoneo per marcatura su cartone, ceramica e vetro. Minimo ordinabile 12 pezzi/multipli. Colori: **R** rosso **N** nero

MAK222. - pennarello a punta tonda mm 4



6



PAINT-RITER® FINE E JUMBO

Pennarello a vernice indelebile. Marca su qualsiasi tipo di superficie pulita (metallo, ceramica, vetro, legno ecc). Perfettamente visibile e opaca, senza solventi nocivi. Resistente all'acqua e agli UV. Resiste a temperature superiori a 100°C. Temperatura di applicazione: -18°C + 66°C.

Colori: **W** bianco **Y** giallo **R** rosso **N** nero.

7 MAK968. - pennarello a punta fine mm 1-2. Minimo ordinabile 12 pezzi/multipli

8 MAK909. - pennarello a punta grossa mm 5-18 mm. Minimo ordinabile 6 pezzi/multipli



7

8



9 QUIK STIK® ALL PURPOSE

Bastoncino di vernice morbida contenuta in tubetto di plastica con rotella, punta Ø mm13. Marcatura morbida, asciuga rapidamente, resistente per tutti i tipi di superfici. Resiste a temperature superiori a 60°C. Temperatura di applicazione: -18°C + 200°C. Minimo ordinabile 12 pezzi/multipli.

Colori: **W** bianco **Y** giallo **R** rosso

MAK610. - stik di vernice in tubetto



9



1 TUBETTO DI VERNICE DI SICUREZZA PER VITI SECURITY CHECK ORIGINAL

Per controlli visivi rapidi su assemblaggi, dadi e bulloni svitati accidentalmente. Una volta asciugata, la vernice si solidifica, il suo colore ad alta visibilità diventa una marcatura molto evidente e una piombatura che si rompe facilmente nel momento del disserraggio. Se applicata su un bullone già stretto, consente di avere un segno di riferimento per ritrovare il punto esatto di serraggio, una volta svitato. Aderisce perfettamente sui metalli e non crea danni alla salute dell'utilizzatore. minimo ordinabile 6 pezzi/multipli.

Colori: **W** bianco **Y** giallo **R** rosso **B** blu **G** verde
MAK668. - tubetto di vernice Security Check Paint



MARCATURA DURABILE SU TUTTE LE BULLONERIE.

ASSICURA CHE I TUOI BULLONI NON SI SPOSTINO O SI SVITINO.

FACILMENTE RIMOVIBILE, IDEALE PER IL CONTROLLO QUALITÀ.



2 TUBETTO VERNICE STYLMARK® ORIGINAL

Vernice opaca, molto visibile. Marca su tutti i tipi di superficie, comprese quelle grasse e rugose, grazie alla punta con sfera in acciaio. Alta resistenza all'acqua e ai raggi UV. Resiste a temperature superiori a 200°C. Temperatura di applicazione: -20°C + 70°C. Minimo ordinabile 12 pezzi/multipli. Colori: **W** bianco **N** nero **Y** giallo **R** rosso

MAK130. - marcatore in tubetto Stylmark®. Misura marcatura mm 3



3 PENNARELLI PERMANENTI DURA-INK® NEEDLE NOSE 5

Pennarello con punta estesa per marcature di precisione attraverso fori, staffe di montaggio etc. Fuoriuscita della punta mm 20. Resiste all'acqua, si asciuga rapidamente. Inchiostro formulato per uso industriale. Minimo ordinabile 6 pezzi/multipli. Colore nero.

MAK520N - pennarello a punta fine mm 1



4 GESSI DI MARCATURA A CERA

Scriva su superfici rugose come acciaio, legno, cartone, mattone, asfalto, resiste alle intemperie e ai raggi UV. Difficilmente cancellabile, misura marcatura Ø mm 11. Temperatura di applicazione: -20°C + 50°C. Minimo ordinabile 12 pezzi/multipli, colori: **W** bianco **Y** giallo

MAK440. - marcatore industriale a cera

MAK441 - porta marcatore industriale, corpo in plastica, molla interna e puntale in alluminio. In confezione singola



5 PAINTSTIK® ORIGINAL B

Stik di vernice indelebile idoneo per la marcatura su qualsiasi tipo di superficie, punta Ø mm 17. Ottima marcatura su superfici **bagnate, oleose, gelate, sporche, grasse, arrugginite**, legno, asfalto. Resiste all'acqua, raggi UV e a temperature superiori a 66°C. Temperatura di applicazione: -46°C + 66°C. Minimo ordinabile 12 pezzi/multipli. Colori: **W** bianco **Y** giallo.

MAK802. - stik di vernice indelebile Paint stik B®





TORCE, FARI E LAMPADE DA LAVORO



1 LAMPADA A LED TUBOLARE

Lampada da lavoro LED tubolare, con gancio girevole e cavo lunghezza 5 mt. Super luminosa (400 lumen) è particolarmente indicata in officina. Emuna una luce diffusa a 360°. Struttura in policarbonato iper resistente. Portata 5 metri. Grado di protezione: IP20. Peso 370 gr. **400 lumen**.

LR540 - dimensioni 460 x 37 x 37 mm

2 TORCIA IN ALLUMINIO

Torcia con corpo in alluminio, robusto e resistente all'acqua. Illuminazione potente e precisa (luminosità pari a 350 Lumen reali x 10W) con possibilità di regolare il fascio di luce. Portata: 300 metri. Funziona con 3 pile AAA (non incluse). Autonomia: 24 ore. Grado di protezione: IP54. Peso 150 gr. **350 Lumen**.

LR247 - dimensioni 137 x 40 x 40 mm



3 TORCIA DA LAVORO CON GANCIO CALAMITATO

Doppia funzione: luce (200 Lumen) o torcia da lavoro con luce focalizzata (30 lumen). Funzionamento: 3 pile AA (non incluse). Peso 170 gr. **200 Lumen**.

LR404 - dimensioni 230 x 60 x 50 mm



4 FARO DA LAVORO LED 1W A BATTERIE

Faro led 1W con comoda maniglia, supporto orientabile, cinghia per il trasporto e adattatore per 4 pile LR20 inclusi. Alimentazione: 1 pila 4R25 o in alternativa con 4 pile LR20 (non incluse). Autonomia: 40 ore. Portata: 150 metri. Grado di protezione: IP44. Peso 700 g. **100 Lumen**.

LR999 - dimensioni 208 x 144 x 162 mm



5 FARO TORCIA RICARICABILE LED 10W + POWERBANK

Faro led 10W. Può essere utilizzato sia come torcia led che come lanterna, grazie alle due lanterne led laterali. Batteria al litio 3,7V, tempo di ricarica: 6 ore circa. Portata: 1000 metri. Autonomia: da 1 a 5 ore a seconda dell'intensità. Peso 900 g. **735 Lumen**.

LR999W - dimensioni 208 x 144 x 162 mm



6 FARETTO RICARICABILE CON POWERBANK

In plastica ultra-spessa ed alluminio in pressofusione, ricaricabile a led con supporto orientabile e funzione powerbank. 3 modalità d'illuminazione: luce intensa, luce normale, luce rossa lampeggiante. Batteria Li-Ion ricaricabile. Autonomia: 3 ore (luce 100%). Grado di protezione IP65. Peso 550 g. **1200 Lumen**.

LR827 - dimensioni 172 x 132 x 42 mm



7 TORCIA A LED IN GOMMA

Torcia tascabile in gomma con 3 superled (durata 50.000 ore), batterie 2D (non incluse). Resistente agli urti e alle intemperie. Focus fino a 30 m. Autonomia 30 ore. Grado di protezione IP X4. peso 185 g (senza batterie). **12 Lumen**.

LR202 - dimensioni 205 x Ø 73 mm



8 TORCIA A LED SUBACQUEA

Torcia leggerissima (181 g) e ultrapotente. Impugnatura in gomma, colore nero/giallo fluo. **Impermeabile fino a 100 m**. 1 led ad alta efficienza, 4 batterie AA (incluse). Portata 66 metri. Autonomia: 5 ore circa. Peso g 181. **28 Lumen**.

OSC155 - dimensioni 160 x 38 x 38 mm



9 TORCIA A LED IN ALLUMINIO

Torcia con funzione zoom (luce regolabile a lunga o breve distanza). Led 3W CREE XPE R3. 2 batterie LR6 (non incluse). Clip per taschino. Batterie 2 x AA (non incluse). Focus fino a 120 m. Autonomia 12 ore. Grado di protezione IP X5. Peso g 70. **140 Lumen**.

LR042 - dimensioni 156 x Ø 28 mm

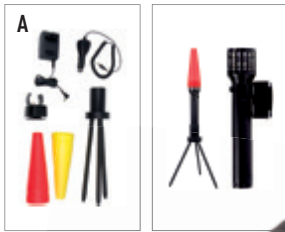

1 TORCIA A LED RICARICABILE



In alluminio, intensità luminosa 20.000 cd. **Comprende (A):** torcia, caricatore 220V 12 V, supporto a muro, 2 coni (1 rosso - 1 giallo), supporto treppiedi h cm 32 (in posizione da lavoro). Batteria ricaricabile Ni-Cd 4,8V 2,2 Ah (tempo di ricarica 8 ore). Autonomia: piena potenza 3 ore, potenza ridotta 9 ore, temperatura operativa -10 ÷ 55 °C. Peso 650 g.

LRD43090 - dimensioni 265 x Ø 55 mm



2



2 TORCIA RICARICABILE

Torcia da lavoro ricaricabile, corpo in ABS finitura gomma. Doppia funzione: luce da ispezione e lampada da lavoro. Fornita con base di ricarica, trasformatore 220V e adattatore 12V. Batterie Li-ion 3,7V 2,2 Ah ricaricabili. Autonomia: 8 ore (luce 50%); 4 ore (luce 100%). Peso 250 g. **300 Lumen.**

LR475 - dimensioni: mm 58 x 40 x 240

3

TORCIA

LUCE
DIFFUSA

3 LAMPADA DA LAVORO RICARICABILE ANTI-BLACK OUT

2 modalità di luce: forte e media. Si accende automaticamente in caso di mancanza di corrente. Trasformatore esterno per utilizzare la lampada senza fili. Autonomia: fino a 5 ore (luce 50%), 2 ore (luce 100%). Batteria Li-Ion 2Ah (tempo di ricarica 5/7 ore). **320 lumen.** Peso 500 g. Grado di protezione IP 20.

LR170 - dimensioni 164 x 104 x 286 mm

NEW



VEDI PAG. 474

LA LUCE CHE PUÒ SALVARTI LA VITA

TORCE PER AREE A RISCHIO ESPLOSIONE

Le torce Nightstick per zone a rischio esplosione (Atex) sono realizzate con materiali di prima qualità, riflettori precisi ed elettronica all'avanguardia. I valori di lumen sono superiori alla maggior parte dei prodotti della concorrenza: tutto questo senza tralasciare il design, semplice e funzionale.

DUAL
LIGHT®
TECHNOLOGY



FARETTI LED 30W

Scocca in policarbonato con rinforzi in PVC. Led 30W (durata media 30.000 ore). Batteria 7,4V 6Ah Li-Ion (tempo di ricarica 3,5 ore). Autonomia 3 ore. Accessori inclusi: adattatore per casa e auto. Funzioni: AC/DC (può essere messo in carica mentre è in funzione), Powerbank (batteria esterna ricaricabile) anti-abbagliamento. **Grado di protezione IP65.**

- 1 **LR223** - faretto ricaricabile, dimensioni 220 x 80 x 191 mm, peso 1,4 kg, **2400 Lumen**
- 2 **LR30S** - faretto con cavo da 3 metri, dimensioni 220 x 75 x 190 mm, peso 1,16 kg, **3000 Lumen**



30W IP65



30W IP65



30W IP54

3 FARETTO LED 30W RICARICABILE CON ALTOPARLANTI BLUETOOTH

Corpo in policarbonato con led 30W. Batteria 7,4V 5 Ah Li-Ion (tempo di ricarica 4,5 ore). 3 livelli di intensità disponibili: 100% (3 ore batteria), 50% (6 ore batteria), 10% (15 ore batteria). Funzione Powerbank: puoi ricaricare il tuo smartphone collegandolo alla lampada tramite cavo USB. Altoparlanti Bluetooth integrati (2 x 5W). Caricatore 220V e da 12V per la macchina inclusi. Grado di protezione IP54. **3000 Lumen.**

LR224 - dimensioni 260 x 100 x 265 mm, peso 1,9 kg



4 TORCIA LED RICARICABILE

Torcia LED 2 in 1 (luce da lavoro - torcia focalizzata). Led High Power 2W. Batteria Li-Ion 3.7V ricaricabile tramite USB. Autonomia: 5 ore (luce da lavoro), 9 ore (torcia). Con gancio e calamita. Portata 30 metri. Caricatore 220V e caricatore auto 12V inclusi. Grado di protezione IP54. **300 Lumen.**

LR409 - dimensioni 180 x 35 x 32 mm, peso 215 g



2W RICARICABILE

3W RICARICABILE

5 TORCIA LED RICARICABILE

Torcia LED 2 in 1 (luce da lavoro - torcia focalizzata) in ABS, ricoperta di superficie gommata. Batteria Li-Ion, ricaricabile tramite USB. Autonomia: 3 ore (luce da lavoro), 8 ore (torcia). 2 ganci e calamita. Portata 10 metri. Cavo USB 1 m, gancio e laccetto inclusi. Grado di protezione IP20. **350 Lumen.**

LR742 - dimensioni 270 x 40 x 45 mm, peso 350 g



50W CAVO 3 MT IP65

SUPPORTO PIEGHEVOLE

6 FARETTO LED 50W

Faretto led 50W a risparmio energetico in alluminio e plastica, resistente e impermeabile. Pieghevole, staffa in metallo orientabile con maniglia imbottita e base larga per una miglior stabilità. Cavo di alimentazione lunghezza 3 mt con presa Schuko. Grado di protezione IP65. **4000 Lumen.**

LR766 - dimensioni 310 x 120 x 340 mm, peso 2,07 kg



10W BATTERIA ALL'USO IP65

FACILE DA TRASPORTARE

7 FARETTO LED 10W RICARICABILE

Faretto led 10W in alluminio e plastica, resistente e impermeabile. Staffa totalmente pieghevole per un ingombro minimo. Semplice da tenere in mano o appendere. Ricaricabile, con batteria Li-Ion 3,7V, autonomia 2 ore. Caricatore USB incluso. Grado di protezione IP65. **600 Lumen.**

LR882 - dimensioni 205 x 63 x 225 mm, peso 780 g



1 LANTERNA DA CANTIERE 30W

In alluminio e policarbonato. Led 30W (durata 30.000 ore), cavo di alimentazione da 5 m con presa Schuko. Maniglia con gancio. Possibilità di collegamento seriale. Fascio di luce diffusa 360°. Installabile su treppiede (non incluso). Peso kg 2,07. Grado di protezione IP54. **2800 Lumen.**

LR188 - lanterna, dimensioni Ø 19 cm x 235 h

2 LAMPADA DA CANTIERE 120W

In policarbonato (non teme le cadute), fascio di luce diffusa 360°. Led 120W (durata 30.000 ore), cavo di alimentazione da 5 m con presa Schuko. Maniglia con gancio. 3 prese Shuko (max 2000W) incluse. Installabile su treppiede (non incluso). Peso kg 3,9. Grado di protezione IP54. **8400 Lumen.**

LR840 - lampada da cantiere, dimensioni 35,5 x 35,5 x 44 cm



3 VENTILATORE A TURBINA

Piedistallo d'appoggio stabile e con ruote. Rotazione silenziosa. Potenza 124 W, 3 livelli di velocità, testa rotabile con angolo di inclinazione fino a 100°. Diametro pale 60 cm.

LRM60 - dimensioni 740 x 780 x 190 mm, peso 11,1 kg

4 GENERATORE DI ARIA CALDA

Forma a cannone per una migliore direzione del flusso d'aria. Ottimo per il riscaldamento immediato di una stanza (utile per asciugare gli intonaci). Lunghezza cavo 140 cm.

LR2000W - generatore potenza 2000W (riscalda 40m³)

LR3000W - generatore potenza 3000W (riscalda 60m³)

LR5000W - generatore potenza 5000W (riscalda 100m³)

PROLUNGA ELETTRICA CON AVVOLGICAVO

Prolunga con 4 prese polivalenti (Schuko 10/16A) e spina grande 16A. Con protezione di sicurezza (in caso di surriscaldamento) e protezione bambini.

5 LR10IT - avvolgicavo, lunghezza 10 metri

6 LR15IT - prolunga con avvolgicavo, lunghezza 15 metri

LR50IT - prolunga con avvolgicavo, lunghezza 50 metri

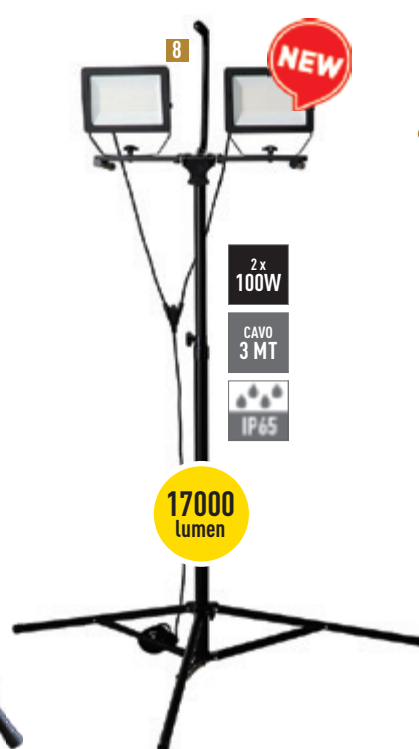

7 LUCE LED 36W RICARICABILE

Corpo in policarbonato (non teme le cadute), con fascio di luce diffusa 360°. Comodo interruttore ON/OFF. LED 36W (durata 30.000 ore). Batteria Li-Ion 7.4V 15Ah, tempo di ricarica 6 ore. Autonomia media: 5 ore. Adattatore AC/DC e tracolla inclusi. Grado di protezione IP54. **3600 Lumen.**

LR090 - dimensioni Ø 82 x 128 cm, peso kg 3,9

8 PROIETTORE LED 200W



2 fari LED 100W in alluminio su treppiede estensibile fino a 200 cm. Potenza 200W. Per l'impiego in condizioni difficili (industrie/cantieri), perfetto per essere utilizzato all'esterno. Cavo di alimentazione lunghezza 3 m con presa Schuko. Grado di protezione IP65. **17000 lumen.**

LR755 - dimensioni 110 x 20 x 12 cm, peso kg 6,8

9 PROIETTORE LED 50W

Faro LED 50W in alluminio, con griglia di protezione, su treppiede estensibile fino a 184 cm. Base larga per una maggiore stabilità. Per l'impiego professionale in condizioni difficili (industrie/cantieri), perfetto per essere utilizzato all'esterno. Fascio di luce: 100°. Cavo di alimentazione lunghezza 3 m con presa Schuko. Grado di protezione IP65. **4000 lumen.**

LR746 - dimensioni 184 x 94 x 94 cm, peso kg 3,4

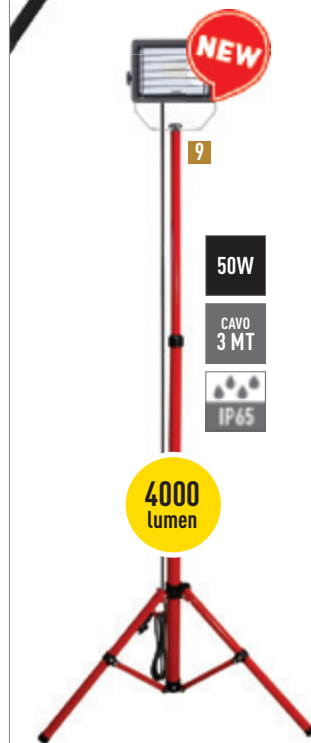



SEGNALATORI LUMINOSI E SONORI



STANDARD ROT

Segnalatori luminosi con parabola girevole disponibili in due modelli (con base piana o base magnetica). A richiesta fornibili cupole di ricambio.

Colori cupole: **A** arancione **B** blu

1 Standard Rot con base piana - dimensioni: Ø mm 150 x 200 h.

LPR12. - luce rotante, 12Vcc. lamp. 45W, omologato per macchine operatrici (giri/min. 180±5)

LPR230. - 240Vca. lampada alogena 42W (giri/min. 180±5)

LPRJ12. - 12 Vcc. lampada Jodio 55W app. europea: (giri/min. 180±5)

LPRJ24. - 24 Vcc. lampada Jodio 70W app. europea: (giri/min. 180±5)

2 Standard Rot con base magnetica - Ø mm 150 x 180 h + magneti. Omologato per macchine operatrici.

LPRB12. - luce rotante 12Vcc. + base magnetica + cavo accendino, lamp. 45W

LPRB24. - luce rotante 24Vcc. + base magnetica + cavo accendino, lamp. 45W

STANDARD - MICRO - SMALL

Segnalatori luminosi lampeggianti con intermittenza elettronica o a luce fissa. A richiesta fornibili cupole di ricambio.

Colori cupole: **R** rosso **Y** giallo **A** arancione **B** blu

3 Standard - base Ø mm 150 x 200 h (80 lampeggi/minuto ±5).

LPL12. - luce lamp. 12Vcc./ca. lamp. 45W omol. per macchine operatrici

LPL24. - 24Vcc./ca. lampada 45W, omologato per macchine operatrici

4 Micro - base Ø mm 85 x 106 h.

LPM12. - luce fissa, 12Vcc./ca., lampada 21W

LPM24. - 24Vcc./ca. lampada 21W

LPM230. - 230 Vca. lampada 15W

5 Small - base Ø mm 125 x 150 h (80 lampeggi/minuto ±5).

LPS12. - luce lampeggiante, 12Vcc./ca., lamp. 21W

LPS24. - 24Vcc./ca. lampada 21 W, omologato per macchine operatrici

ACCESSORI PER LAMPEGGIANTI STANDARD

6 LPCA - cavo estensibile m 2,5 con presa per accendino

LPCD - cavo estensibile m 2,5 con presa e spina, per collegamenti in mancanza di presa accendino

7 LPAM - serie di 3 calamite adatte per LPL



8 LAMPALLARM MT

Segnalatore lampeggiante a base piana (110 lampeggi/minuto ±20). **Grado di protezione IP54.** Dimensioni: base Ø mm 167 x 208 h, peso kg 0,5.

LA012. - Lampallarm 12Vcc. solo corrente continua

LA024. - Lampallarm 24Vcc. solo corrente continua

LA240. - Lampallarm 240Vca. solo corrente alternata

Colori cupole: **R** rosso **Y** giallo

A arancione

9 ROTALLARM

Segnalatore Rotallarm BA 15s 45W a base piana (160 giri al minuto ± 30). **Grado di protezione IP65.** Dimensioni: base Ø mm 167 x 208 h, peso kg 1.

RA12. - Rotallarm 12Vcc. (a richiesta fornibile versione a corrente alternata)

RA24. - Rotallarm 24Vcc. (a richiesta fornibile versione a corrente alternata)

RA230. - Rotallarm 240Vca. (a richiesta fornibili le versioni 48 o 110Vca)

Colori cupole: **R** rosso **Y** giallo

A arancione **B** blu

10 MICROSAL AVVISATORE ACUSTICO

Avvisatore acustico elettromeccanico progettato per applicazioni industriali, sviluppato con capsula acustica elettromagnetica a membrana vibrante. Ideale per brevi segnalazioni di chiamata o di allarme. Caratteristiche: 95dB (A) 1 m, 300±350 Hz. **Grado di protezione IP65.** Dimensioni: base Ø mm 139,5 x 63,5 h.

MSN24 - avvisatore acustico 24Vca., solo corrente alternata

MSN230 - avvisatore acustico 240Vca., solo corrente alternata

11 ACCESSORI E RICAMBI

BM3 - base a tre magneti oscillanti munita di cavo lungo m 3 con spina accendisigari. Adatta per segnalatori modelli LAMPALLARM e ROTALLARM

CR. - cupole di ricambio adatte solo per i lampeggiatori LAMPALLARM MT **10** e ROTALLARM **11** (alla sigla CR far seguire la sigla del lampeggiatore e quella del colore)

i LAMPALLARM E ROTALLARM DISPONIBILI, A RICHIESTA, IN VERSIONE ANTIDEFLAGRANTE PER ATMOSFERE ESPLOSIVE CLASSIFICAZIONE II B.



SISTEMI PER LA PREVENZIONE DEI RISCHI

NASTRI E STRISCE ANTISCIVOLO STANDARD SAFE IN®	252-253
NASTRI ANTISCIVOLO VARI E FOTOLUMINESCENTI SAFE IN®	254
PRODOTTI ANTISCIVOLO E FOTOLUMINESCENTI.....	255-256
SISTEMI DI PROTEZIONE PER INDUSTRIE	257
SISTEMI DI PROTEZIONE PERIMETRALI PER AREE INDUSTRIALI	258-259
SISTEMI DI PROTEZIONE PER MACCHINE UTENSILI	260
GRIGLIATI COMPONENTI E PANNELLI DI LAMINATO IN VETRORESINA.....	261
PEDANE E TAPPETI DEFATICANTI	262-265
TAPPETO ANTIPOLVERE E PER PROTEZIONE GINOCCHIA	265
PEDANA RISCALDANTE E TAPPETI PER IL TRAFFICO PEDONALE.....	266
TAPPETI SANIFICANTI E PERSONALIZZABILI	267
PROTEZIONI ERGONOMICHE, SUPPPORTI LOMBARI ED ESOSCHELETRO... ..	268-269
ETICHETTE E TARGHETTE DI IDENTIFICAZIONE, ASTE GRADUATE.....	270-272
BOLLINI DATARIO E PIASTRINE NUMERATE	273
SISTEMI DI PROTEZIONE PER VETRI.....	274



NASTRI E STRISCE ANTISCIVOLO



FORNIBILI NEI SEGUENTI COLORI:

- W** BIANCO
- N** NERO
- S** GRIGIO
- T** TRASPARENTE
- R** ROSSO
- Y** GIALLO
- F** GIALLO FLUO
- B** BLU
- G** VERDE
- NY** NERO-GIALLO
- RW** ROSSO-BIANCO



FORNIBILI IN 3 ALTEZZE DIVERSE

1 NASTRO ANTISCIVOLO TIPO "STANDARD"

Nastro antiscivolo standard con rivestimento antiscivolo medio, costituito da particelle abrasive di silicio su supporto di poliestere. Adatto ad un'ampia gamma di applicazioni generali, può essere applicato su qualsiasi superficie regolare. Ideale per aree ad intenso traffico pedonale e veicolare, può essere utilizzato come antiscivolo sia sui gradini o intere aree piane. Resiste a temperature tra -30°C e +70°C, a raggi UV, prodotti chimici, oli, ecc. Disponibile in un'ampia gamma di colori.

SWDS25. - rotolo standard altezza mm 25, lunghezza 18,3 m (specificare lettera colore)

SWDS50. - rotolo standard altezza mm 50, lunghezza 18,3 m (specificare lettera colore)

SWDS100. - rotolo standard altezza mm 100, lunghezza 18,3 m (specificare lettera colore)

INFORTUNI DA SCIVOLAMENTO: ALCUNI DATI

Secondo i dati diffusi da Inail, il maggior numero di infortuni in tutti i settori, dall'industria pesante al lavoro d'ufficio, è dovuto a scivolamenti, inciampi e cadute. Questi rappresentano circa il 24% del totale degli incidenti: la caduta in piano che determina gli infortuni da scivolamento è la causa più frequente di infortunio sul lavoro nella fascia di età compresa tra i 45 e i 54 anni, con una percentuale pari al 27% che arriva al 33% tra i 55 e 64 anni fino a toccare il 45% tra gli over 65. I datori di lavoro hanno la responsabilità di tutelare i propri dipendenti dal rischio di incidenti, garantendo un ambiente lavorativo il più possibile sicuro. Inoltre può succedere di scivolare anche in ambiente domestico o nello svolgimento di attività quotidiane: camminando su un pavimento bagnato o su liquido rovesciato a terra (ad esempio in un supermercato), inciampando in una mattonella rovinata o in qualunque oggetto posizionato in un locale con scarsa illuminazione e utilizzando scale poco sicure.

L'IMPORTANZA DEI NASTRI ANTISCIVOLO

Per evitare di perdere l'equilibrio e cadere, bisogna utilizzare nastri antiscivolo extra aderenti. Dotati di un potente collante che si attacca a qualunque tipo di supporto, aiutano a prevenire gli incidenti. La loro forza è nell'estrema resistenza del materiale che viene a contatto con le soles. I nastri vengono, nella maggioranza dei casi, applicati all'interno su gradini, scale, rampe, ma anche piatti doccia, pavimenti di spogliatoi e bordi piscina. Gli ambiti di utilizzo sono quindi molteplici: impianti di produzione, magazzini e logistiche, edifici pubblici e privati, mezzi di trasporto, luoghi di aggregazione (cinema, teatri, palestre, centri sportivi, etc.).



ISTRUZIONI D'USO



Pulire la superficie dove andrà applicato il nastro o le strisce antiscivolo



Con le forbici, tagliare il nastro o le strisce nella lunghezza desiderata



Rimuovere delicatamente la pellicola protettiva dal nastro o dalle strisce



Applicare il nastro o le strisce sulla superficie scelta e attendere qualche minuto prima di calpestarla

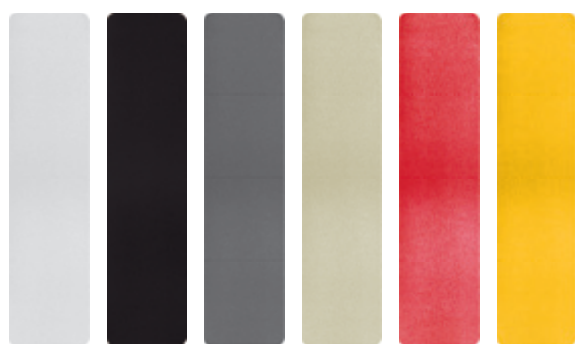

FORNIBILI IN 11 COLORI DIVERSI



FORNIBILI NEI SEGUENTI COLORI:

- W** BIANCO
- N** NERO
- S** GRIGIO
- T** TRASPARENTE
- R** ROSSO
- Y** GIALLO
- F** GIALLO FLUO
- B** BLU
- G** VERDE
- NY** NERO-GIALLO
- RW** ROSSO-BIANCO

2 STRISCE ANTISCIVOLO TIPO "STANDARD"

Strisce antiscivolo standard con rivestimento antiscivolo medio, costituito da particelle abrasive di silicio su supporto di poliestere. Adatte ad un'ampia gamma di applicazioni generali, possono essere applicate su qualsiasi superficie regolare. Ideali per aree ad intenso traffico pedonale e veicolare, da utilizzarsi come antiscivolo sia sui gradini che su intere aree piane. Resistono a temperature tra -30°C e +70°C, a raggi UV, prodotti chimici, oli, ecc. Disponibili in un'unica dimensione e in un'ampia gamma di colori. **Minimo ordinabile 25 strisce/multipli.**

SWDS6115. - strisce antiscivolo, dimensioni mm 610 x 150 (specificare lettera colore)



1 NASTRO ANTISCIVOLO TIPO "IMPERMEABILE"

Rivestimento che garantisce una pavimentazione antiscivolo con una finitura più liscia. Idoneo per ambienti con presenza d'acqua ed elevata umidità (piscine, imbarcazioni, spogliatoi, strutture sportive, docce ecc). Ideale per l'industria alimentare grazie all'assenza di avvallamenti e interstizi. Lunghezza rotolo 18,3 m.

Colori: **W** bianco **N** nero **S** grigio **T** trasparente

SWDI25. - rotolo altezza mm 25

SWDI50. - rotolo altezza mm 50

SWDI100. - rotolo altezza mm 100



NASTRI TIPO "IMPERMEABILE": ADATTI IN AMBIENTI CON PRESENZA DI UMIDITÀ



2 NASTRO ANTISCIVOLO TIPO "CONFORMABILE"

Costituito da particelle abrasive cosparse su supporto di alluminio flessibile con potente retro adesivo per adattarsi a superfici irregolari. Consigliato per superfici curve e non uniformi (scale bucciate, passerelle, macchine per la movimentazione ecc). Resiste a temperature tra -30°C e +70°C. Lunghezza rotolo 18,3 m.

Colori: **N** nero **Y** giallo **NY** nero-giallo

SWDC50. - rotolo altezza mm 50

SWDC100. - rotolo altezza mm 100



NASTRI TIPO "CONFORMABILE": ADATTI A SUPERFICI IRREGOLARI

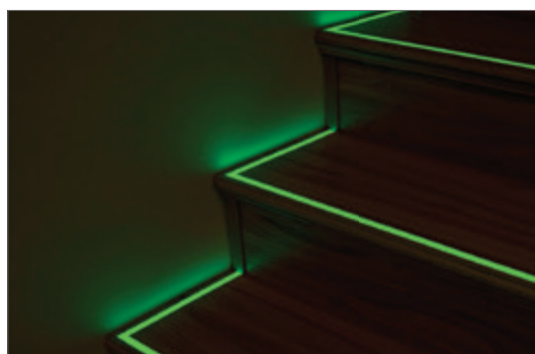

NASTRO ANTISCIVOLO FOTOLUMINESCENTE

Stesse caratteristiche del tipo "standard" ma in versione fotoluminescente. Rende visibile il percorso da seguire in caso di interruzione della corrente e di prevenire il rischio di scivolate e di cadute. Colori: fotoluminescente e nero con banda centrale fotoluminescente alta 1 cm.

3 **SWDF50F** - rotolo fotoluminescente, lunghezza 18,3 m, altezza mm 50

4 **SWDF50NF** - rotolo nero con banda centrale fotoluminescente, lunghezza 18,3 m, altezza mm 50



SEGNALETICA ANTISCIVOLO FOTOLUMINESCENTE A PAGINA 91.

NASTRI FOTOLUMINESCENTI: ADATTI IN MANCANZA DI CORRENTE ELETTRICA



DECRETO LEGISLATIVO 81/08

Il Decreto, riguardante "il miglioramento della sicurezza e della salute dei lavoratori sul luogo di lavoro", prevede, all'allegato IV, che i pavimenti degli ambienti di lavoro e dei luoghi destinati al passaggio "...devono essere in condizioni tali da rendere sicuro il movimento ed il transito delle persone", ed in particolare che i pavimenti dei locali debbano essere "...fissi, stabili ed antiscrucciolevoli".

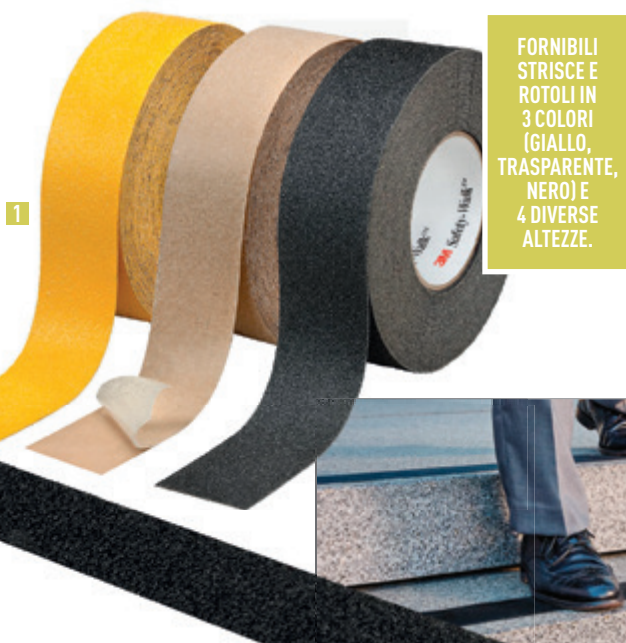

FORNIBILI STRISCE E ROTOLI IN 3 COLORI (GIALLO, NERO) E 4 DIVERSE ALTEZZE.

1 SAFETY-WALK™ GENERAL PURPOSE

Rivestimento antiscivolo costituito da particelle abrasive aggregate da resine sintetiche su un robusto supporto autoadesivo. Indicato per tutte le superfici soggette ad intenso traffico sia pedonale sia veicolare (rampe, scale, passerelle, montacarichi, pedane di macchinari, ingressi, corridoi). Disponibile in strisce o in rotoli lunghezza 18,3 metri.

SWS150 - strisce Safety-Walk™ General Purpose colore nero, dimensioni mm 150 x 610. Minimo ordinabile 10 strisce/multipli

SWN019 - rotolo Safety-Walk™ General Purpose colore nero, altezza mm 19

SWN022 - rotolo Safety-Walk™ General Purpose trasparente, altezza mm 25

SWN023 - rotolo Safety-Walk™ General Purpose colore giallo, altezza mm 25

SWN050 - rotolo Safety-Walk™ General Purpose colore nero, altezza mm 50

SWN052 - rotolo Safety-Walk™ General Purpose trasparente, altezza mm 50

SWN100 - rotolo Safety-Walk™ General Purpose colore nero, altezza mm 100

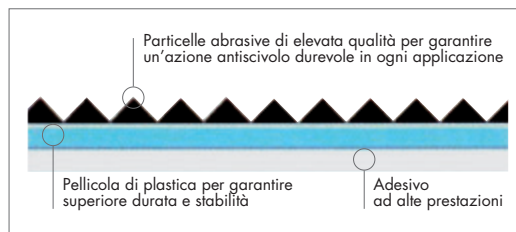

ADATTO A SUPERFICI IRREGOLARI

2 SAFETY-WALK™ CONFORMABLE

Rivestimento antiscivolo costituito da particelle abrasive cosparse su un supporto di alluminio flessibile per adattarsi a superfici irregolari. Indicato per a superfici curve e non uniformi (scale a pioli e di magazzino, passerelle, serbatoi, veicoli speciali, tra cui, carrelli elevatori, macchine movimento terra, gru, betoniere). Spessore medio mm 0,9. Escursione termica sopportata -29°C/+65°C. Buona resistenza alle sostanze chimiche. Colore nero. Disponibile in rotoli lunghezza 18,3 metri.

SWC050 - rotolo Safety-Walk™ Conformable altezza mm 50

SWC100 - rotolo Safety-Walk™ Conformable altezza mm 100

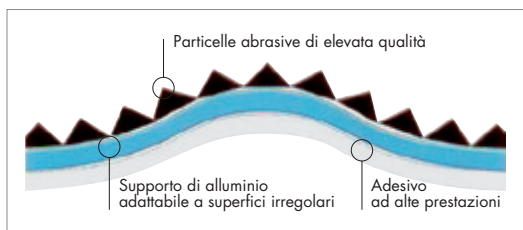

3 SAFETY-WALK™ COARSE

Rivestimento antiscivolo composto da particelle abrasive di elevata dimensione aggregate da resine sintetiche su un robusto supporto. Mantiene le proprietà antiscivolo in presenza di detriti, fango e oli. Idoneo in condizioni critiche in presenza di polveri e detriti: attrezzature e macchine agricole, cantieri stradali, veicoli e attrezzature per edilizia, macchine movimento terra, gru. Colore nero. Disponibile in rotoli lunghezza 18,3 metri.

SWE050 - rotolo Safety-Walk™ Coarse altezza mm 50

SWE100 - rotolo Safety-Walk™ Coarse altezza mm 100

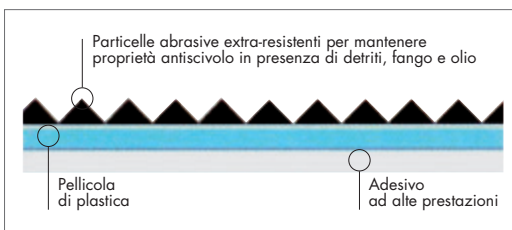

4 ADESIVO SPRAY

Adesivo ideale per incementare l'adesione istantanea e nel tempo di materiali autoadesivi, quando per il tipo di superficie, la normale adesione degli stessi è insufficiente a soddisfare l'applicazione.

SWA077 - bombola adesivo spray (ml 500). Resa 8 m²





PRODOTTI ANTISCIVOLO

Articoli antiscivolo per gradini



1

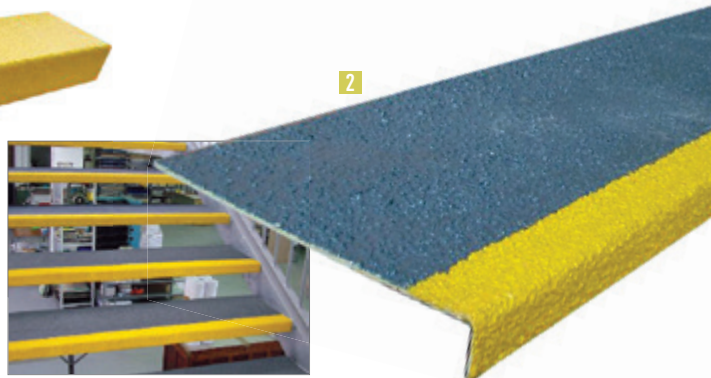

2



1 ANGOLARI DI SICUREZZA IN VETRORESINA

Angolari di sicurezza, dimensioni mm 70 x 40. Rappresentano una soluzione economica per risolvere i problemi di scivolamento delle scale esistenti. Caratterizzati da sagoma smussata, superficie antiscivolo integrato-permanente e colore giallo sicurezza. Fissaggio semplice mediante adesivo poliuretano o bulloneria. Spessore mm 3,2.

NDRA57 - angolare di sicurezza lunghezza mm 500. Minimo ordinabile 6 pezzi/multipli

NDRA67 - angolare di sicurezza lunghezza mm 600. Minimo ordinabile 5 pezzi/multipli

NDRA77 - angolare di sicurezza lunghezza mm 750. Minimo ordinabile 4 pezzi/multipli

NDRA107 - angolare di sicurezza lunghezza mm 1000. Minimo ordinabile 3 pezzi/multipli

2 COPRIGRADINI IN VETRORESINA

Rendono sicure le scale in tutti gli ambienti civili ed industriali. Possono essere applicati su gradini in legno, cemento, acciaio, etc. Esecuzione antiscivolo con grani di silice integrati nella struttura per un'ottima resistenza allo scivolamento in tutte le condizioni (acqua, ghiaccio, grasso, etc.). Barra frontale gialla che rende ben visibile la battuta al piede. Il coprigradino copre oltre al piano anche l'angolo per 3 cm. Fissaggio semplice mediante adesivo poliuretano o bulloneria. Per installazione su grata utilizzare i gruppi "sella" universali. Spessore mm 3,5.

NDRA151 - lunghezza mm 500, dimensioni mm 150 x 3,5. Minimo ordinabile 6 pezzi/multipli

NDRA152 - lunghezza mm 600, dimensioni mm 150 x 3,5. Minimo ordinabile 5 pezzi/multipli

NDRA153 - lunghezza mm 750, dimensioni mm 150 x 3,5. Minimo ordinabile 4 pezzi/multipli

NDRA154 - lunghezza mm 1000, dimensioni mm 150 x 3,5. Minimo ordinabile 3 pezzi/multipli

NDRA231 - lunghezza mm 500, dimensioni mm 230 x 3,5. Minimo ordinabile 6 pezzi/multipli

NDRA232 - lunghezza mm 600, dimensioni mm 230 x 3,5. Minimo ordinabile 5 pezzi/multipli

NDRA233 - lunghezza mm 750, dimensioni mm 230 x 3,5. Minimo ordinabile 4 pezzi/multipli

NDRA234 - lunghezza mm 1000, dimensioni mm 230 x 3,5. Minimo ordinabile 3 pezzi/multipli

NDRA525 - gruppo "sella" universale in acciaio inox

COME INSTALLARE COPRIGRADINI ED ANGOLARI

Installazione su pedana:

usare viti autotrapananti e/o adesivo sigillante.



Installazione su grata:

usare i gruppi "sella" universali.

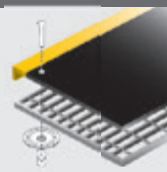

Prodotti antiscivolo



3

3 SAFE STEP® 100 VERNICE ANTISCIVOLO

Resina epossidica monocomponente con granuli di silicio. Elevate prestazioni adatto a zone umide e ambienti grassi, di intenso traffico pedonale, interne o esterne. Resistente alla maggior parte di oli, acidi, alcali e solventi. Ideale per impiego su rampe, scale e ambienti lavorativi. Si applica facilmente e si adatta a superfici quali: cemento, legno, metallo e superfici composite. Tempo di indurimento, asciugatura: 12 ore per zone poco trafficate, 72 ore per zone molto trafficate, a 21°C. Latta da lt 5 per una copertura di circa 5 m², se applicato con rullo. Si consiglia l'utilizzo del Safe Step® Primer se applicato su superfici porose quali ad esempio il cemento o il legno.

ROC43266 - latta da lt 5 di vernice antiscivolo Safe Step® 100, colore grigio



4

4 SAFE STEP® 200 VERNICE ANTISCIVOLO

Vernice epossidica bicomponente ad alta resistenza caricata con granuli di ossido di alluminio. Elevate prestazioni adatto a zone di particolare traffico di macchinari e pedonale. Resistente agli acidi, alcali, solventi, grassi, oli e acqua salata. Altamente coprente anche su superfici non uniformi, irregolari e ruvide. Tempo di indurimento, asciugatura: 24 ore per zone poco trafficate, 48 ore per zone molto trafficate, a 20°C. Adatta a superfici quali: cemento, legno, metallo e superfici composite. Latta da lt 5 per una copertura di circa 5 m², se applicato con rullo. Si consiglia l'utilizzo di un Primer se applicato su superfici porose quali ad esempio il cemento o il legno.

ROC43320 - latta da lt 5 di vernice antiscivolo Safe Step® 200, colore grigio



5

5 SAFE STEP® SPRAY ANTISCIVOLO

Rimedio immediato per rendere antiscivolo la maggior parte delle superfici. Resistente a oli, grassi, detersivi, acidi diluiti e alcali. Trasparente, molto resistente, asciugatura rapida, adatto per uso interno ed esterno. Può essere spruzzato su: metallo, legno, pietra, mattonelle, cemento e marmo. Ideale per tutte le zone di intenso traffico pedonale. Bombola da ml 400 per una copertura di 1,5 - 2,5 m².

ROC45000 - bombola spray antiscivolo da ml 400





! LA VIGENTE "DIRETTIVA MACCHINE" PREVEDE CHE LE SCALE A PIOLI FISSE DISPONGANO DI UNA BARRIERA A CHIUSURA AUTOMATICA.

1 DISPOSITIVO ANTINTRUSIONE PER SCALE A PIOLI

Realizzato in metallo leggero ad alta resistenza e pensato per inibire l'utilizzo delle scale verticali al personale non abilitato e non dotato di idonei DPI. La porta è dotata di apposite asole per l'alloggiamento di un lucchetto (non fornito). **Altezza fissa 180 cm:** disponibile in varie larghezze e grafica personalizzabile.

MUC180. - dispositivo antintrusione larghezza personalizzabile (indicare in cm la larghezza desiderata)

MUC18036 - dispositivo antintrusione larghezza 36 cm

MUC18040 - dispositivo antintrusione larghezza 40 cm

MUC18042 - dispositivo antintrusione larghezza 42 cm

MUC18045 - dispositivo antintrusione larghezza 45 cm

MUC18047 - dispositivo antintrusione larghezza 47 cm

MUC18050 - dispositivo antintrusione larghezza 50 cm

2 DISPOSITIVO SALVADITA PER CHIAVI POLIGONALI

Per chiavi poligonali a percussione (chiavi "a battere"). Azzerata la possibilità di infortunio durante le fasi di montaggio/smontaggio tiranti. Si applica al corpo della chiave poligonale, allontanando la mano dal punto di battuta chiave/martello. Non trasmette vibrazioni, prevenendo così la sindrome del tunnel carpale.

MUP375 - dispositivo salvadita mm 375

MUP850 - dispositivo salvadita mm 850

3 CANCELLI DI SICUREZZA A CHIUSURA AUTOMATICA PER SCALE A PIOLI

Sviluppati per chi lavora in altezza e che assicurano la continuità del parapetto e della barra intermedia. In materiale composito resistente alla corrosione, alle sostanze chimiche, ai raggi UV, antistatici e con bordi non affilati. Fornibili con due direzioni di rotazione (apertura a destra o a sinistra). Robusti, facili da installare, disponibili in 2 larghezze. Colore giallo (RAL 1023). A norma EN 14122-3 e 14122-4.

MUP094 - cancello di sicurezza automatico, apertura fino a 940 mm

MUP120 - cancello di sicurezza automatico per scale a pioli, apertura fino a 1200 mm



4 DISPOSITIVO DI SICUREZZA ANTIURTO IN POLIURETANO PER STELI VALVOLA

Soluzione efficace per la protezione degli infortuni dovuti alla pericolosa presenza di elementi fuori sagoma su impianti, come steli valvola, tubi di spurgo, tiranti di scambiatori a piastre, ecc. Grazie alla forma tubolare, protegge anche dall'ossidazione sia la filettatura dello stelo sia il grasso lubrificante. Disponibili in spezzoni da 1 metro con diversi diametri stelo valvola: da 15 a 90 mm (ogni 5 mm: 15, 20, 25...).

MUP001.. - dispositivo di sicurezza antiurto. Il codice si forma aggiungendo il diametro dello stelo dove dovrà essere applicato (es. MUP00125 stelo Ø mm 25)

5 LEVA DI MANOVRA ANTISCINTILLA CERTIFICATA



Leva antiscintilla ideale per manovrare in sicurezza le valvole a volantino. Realizzata a sezione rettangolare in unico pezzo senza saldature, con manico ergonomico in elastomero rinforzato in Ryon. Certificata Atex direttiva 94/9/EC impieghi in zone Atex 1-2-21-22. Norme: EN1127-1-2007 e EN13463-1-2007.

MUP005 - rastrelliera cm 50 x 5 leve di manovra

Da abbinare ad uno dei seguenti codici:

MUP060 - leva lunghezza mm 270, per volantino Ø 10 - 50 mm

MUP580 - leva lunghezza mm 280 per volantino Ø 25 - 80 mm

MUP100 - leva lunghezza mm 340, per volantino Ø 50 - 100 mm

MUP250 - leva lunghezza mm 450, per volantino Ø 125 - 250 mm

MUP400 - leva lunghezza mm 620, per volantino Ø 250 - 400 mm

MUP900 - leva lunghezza mm 830, per volantino Ø 350 - 900 mm

6 BARRIERA UNIVERSALE LUCCHETTABILE PER SPAZI CONFINATI

Le normative sempre più restrittive, per l'accesso agli spazi confinati, richiedono un accesso controllato. Questa barriera realizzata in acciaio, è stata pensata per agevolare il montaggio grazie a 4 punti di ancoraggio e può essere lucchettabile. Ad alta visibilità, viene fornita in diverse dimensioni.

MUP562 - barriera per passi d'uomo da mm 450 x 620

MUP483 - barriera per passi d'uomo da mm 640 x 830

MUP112 - barriera per passi d'uomo da mm 830 x 1120

MUP170 - barriera per passi d'uomo da mm 1410 x 1700

MUP200 - barriera per passi d'uomo da mm 1700 x 2000



PROTEZIONI MODULARI PROGETTATE SECONDO I CRITERI CONTENUTI NELLE SEGUENTI NORMATIVE

UNI EN 953: Sicurezza del macchinario - ripari - requisiti generali per la progettazione e la costruzione dei ripari fissi e mobili.

UNI EN ISO 12100-1/2: Sicurezza del macchinario. Concetti fondamentali, principi generali di progettazione per la realizzazione e costruzione dei ripari fissi e mobili.

UNI EN 13849-1: Sicurezza del macchinario - Parti dei sistemi di comando legate alla sicurezza - Principi generali per la progettazione.

CEI EN 60204-1: Sicurezza sul macchinario. Equipaggiamento sulle macchine.

CEI 44-5 Parte 1: Regole generali.

UNI EN 13857: Distanze di sicurezza per impedire il raggiungimento di zone pericolose con gli arti superiori e inferiori.

UNI EN 349: Sicurezza del macchinario. Spazi minimi per evitare lo schiacciamento di parti del corpo.

UNI EN 1088: Sicurezza del macchinario. Dispositivi di interblocco associati ai ripari. Principi di progettazione e di scelta.

DIRETTIVA 2006/42/CE: Direttiva macchine.

Sistema modulare TECHNO

Sistema di sicurezza in acciaio TECHNO, creato per offrire una soluzione economica e di semplice installazione per coloro che devono delimitare aree pericolose. Questo prodotto nasce come pannello auto-portante, con una rete studiata per migliorare la visione del macchinario segregato. Il sistema comprende pannelli per composizioni in linea o angolari, porta ad anta singola e tutti gli accessori necessari al suo montaggio. Colore giallo RAL 1003.



MODULARE

Il sistema Techno è intercambiabile con gli altri nostri sistemi, in modo da sfruttare la robustezza di un sistema e la flessibilità dell'altro.



VISIBILE

Il sistema innovativo della rete migliora la visione del macchinario all'interno della zona segregata.



MODIFICHE IN OPERA

Il sistema può essere modificato in corso d'opera mediante l'utilizzo di pochissimi attrezzi e senza essere riverniciato.



ECONOMICO

Il costo del sistema è molto contenuto perché realizzato in rete auto-portante.

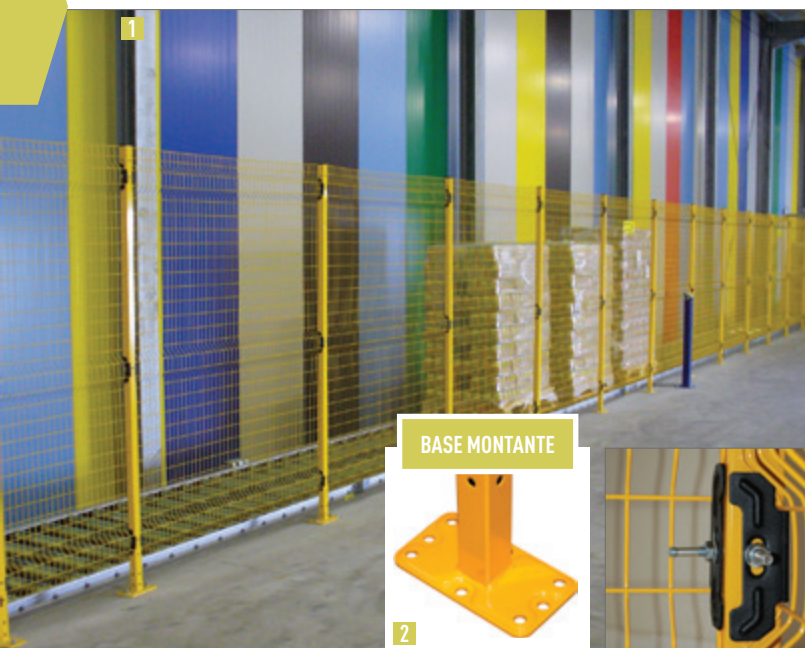

1

BASE MONTANTE



2

1 PANNELLI

Pannelli con rete mm 32 x 67, filo Ø mm 3.

PRO001 - pannello TECHNO mm 250 x 1840 (b x h)

PRO002 - pannello TECHNO mm 420 x 1840 (b x h)

PRO003 - pannello TECHNO mm 700 x 1840 (b x h)

PRO004 - pannello TECHNO mm 1020 x 1840 (b x h)

PRO005 - pannello TECHNO mm 1220 x 1840 (b x h)

PRO006 - pannello TECHNO mm 1500 x 1840 (b x h)

2 KIT MONTANTE 40 X 40

PRO113 - Kit montante composto da: montante STD con piastra mm 100 x 180 per grani M8, h mm 2000, tappo alettato di chiusura mm 40 x 40 (1 pezzo), tasselli a terra FBT10/50 + 58 a terra da M10 (2 pezzi), fissaggio pannello Techno INTERMEDIO (1 kit da 6 pezzi)

PRO110 - kit montante angolare composto da: montante STD con piastra mm 100 x 180 per grani M8 angolare, h mm 2000, tappo alettato di chiusura mm 40 x 40 (1 pezzo), tasselli a terra FBT10/50 + 58 a terra da M10 (2 pezzi), fissaggio pannello Techno ANGOLARE (1 kit da 6 pezzi)



3

4

3 PORTE

Porte ad anta singola colore giallo, antigraffio, complete di 2 montanti, 4 tasselli, 1 pannello colore nero e traversa superiore (comprende maniglia, 2 cerniere e 2 battute).

PRO700 - porta TECHNO ad anta singola, base mm 700

PRO1000 - porta TECHNO ad anta singola, base mm 1000

PRO1200 - porta TECHNO ad anta singola, base mm 1200

PRO1500 - porta TECHNO ad anta singola, base mm 1500

4 KIT MICRO PER PORTA AD ANTA SINGOLA

Per porta ad anta singola con traverso superiore, adatto per il controllo delle porte che proteggono parti pericolose di macchine. Utilizza un microinterruttore di sicurezza che lavora direttamente sulla cerniera; una volta posizionato e spinato, diventa solidale alla stessa cerniera.

PRO101 - micro interruttore di sicurezza elettrico



A RICHIESTA FORNIBILI ALTRE TIPOLOGIE DI PORTE: A DUE ANTE, AD UN'ANTA SCORREVOLE, A DUE ANTE SCORREVOLI.



Esempi di costruzione sistemi perimetrali



ESEMPIO DI COSTRUZIONE DI UNA PROTEZIONE LINEARE DA 6 METRI

- **PRO006** - 4 pezzi pannello TECHNO mm 1500 x 1840 h
 - **PRO113** - 5 pezzi kit montante 40 x 40 composto da:
 - 5 montanti STD con piastra mm 100 x 180 per grani M8, h mm 2000
 - 5 tappi alettati di chiusura mm 40 x 40
 - 10 tasselli a terra FBT10/50 + 58 a terra da M10
 - 5 kit (da 6 pezzi) per fissaggio pannello Techno INTERMEDIO
- Eventuale aggiunta di porta ad anta singola:
- **PRO1500** - porta TECHNO ad anta singola, base mm 1500, complete di 2 montanti, 1 pannello e traversa superiore (comprende maniglia, 2 cerniere e 2 battute)



ESEMPIO DI COSTRUZIONE DI UNA PROTEZIONE CON ANGOLO DA 6 METRI

- **PRO006** - 4 pezzi pannello Techno mm 1500 x 1840 h
- **PRO113** - 4 pezzi kit montante 40 x 40 composto da:
 - 4 montanti STD con piastra mm 100 x 180 per grani M8, h mm 2000
 - 4 tappi alettati di chiusura mm 40 x 40
 - 8 tasselli a terra FBT10/50 + 58 a terra da M10
 - 4 kit da 6 pezzi - fissaggio pannello Techno INTERMEDIO
- **PRO110** - 1 pezzo kit montante angolare composto da:
 - 1 montante STD con piastra mm 100 x 180 per grani M8 Techno angolare, h mm 2000
 - 1 tappo alettato di chiusura mm 40 x 40
 - 2 tasselli a terra FBT10/50 + 58 a terra da M10
 - 1 kit (da 6 pezzi) per fissaggio pannello Techno angolare



SE TRA I PRODOTTI DI QUESTE PAGINE NON TROVI CIÒ CHE DESIDERI, CONTATTACI PER UN PREVENTIVO PERSONALIZZATO. SAPREMO OFFRIRTI UN PROGETTO COMPLETO E ADATTO ALLE TUE ESIGENZE!



SISTEMI DI PROTEZIONE PER MACCHINE UTENSILI



1 SCHERMO PER MOLATRICE

Schermo in acciaio e materiale plastico antiurto.

RIP001 - dimensioni schermo: mm 150 x 150

RIP002 - dimensioni schermo: mm 210 x 210

2 CUPOLE

Schermo con struttura in acciaio e materiale plastico antiurto da installare sulle basi delle protezioni: RIPA1, RIPA2, RIPA3, RIPO06, RIPO03D e RIPO03S.

RIP300 - cupola Ø 300 mm

RIP350 - cupola Ø 350 mm

RIP400 - cupola Ø 400 mm

RIP450 - cupola Ø 450 mm

RIP500 - cupola Ø 500 mm

RIP600 - cupola Ø 600 mm

RIP700 - cupola Ø 700 mm



TIPOLOGIE DI ATTACCHI

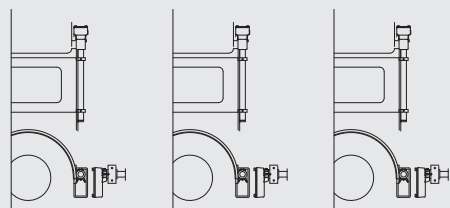

ATTACCO A1

ATTACCO A2

ATTACCO A3



DIMENSIONI RIP004 (mm)

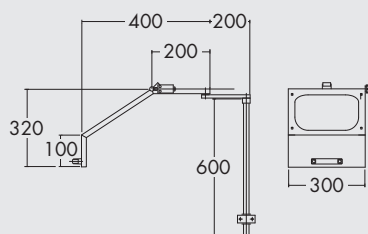

3 PROTEZIONE PER TORNO

Composta da base con attacco per sostegno schermo, completo di microinterruttore di sicurezza e palo di supporto. Al sistema bisogna aggiungere una delle cupole presenti nella pagina, in base alle esigenze (codici da RIP300 a RIP700).

RIPA1 - base con attacco A1

RIPA2 - base con attacco A2

RIPA3 - base con attacco A3

4 PROTEZIONE PER TORNO

In lamiera di acciaio completa di schermo in materiale plastico antiurto. Da installare sul carrello del tornio.

RIPO04 - protezione per tornio

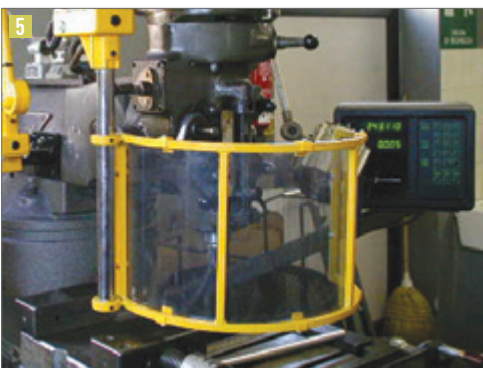

5 PROTEZIONE PER FRESATRICE

Struttura composta da un braccio snodato, dotata di due impianti di micro. Alla struttura bisogna aggiungere una delle cupole presenti nella pagina, in base alle esigenze (codici da RIP300 a RIP700).

RIP003D - struttura con attacco destro (cupola esclusa)

RIP003S - struttura con attacco sinistro (cupola esclusa)



6 PROTEZIONE PER TRAPANO RADIALE

Base per schermo per trapano radiale, regolabile in altezza. In materiale plastico antiurto, dotata di microinterruttore. Cupola codice RIP300 non compresa.

RIP006 - base protezione per trapano radiale



7 PROTEZIONE PER TORNO

Da installare posteriormente alla macchina. Composta da montanti da fissare a terra (tasselli non forniti) e pannelli ad estrazione rapida per facilitare le operazioni di pulizia della macchina. Realizzata con struttura in acciaio e pannelli in rete (maglia quadra) e tamponatura in PVC. Spessore mm 4. Altre dimensioni fornibili a richiesta.

RIPO05 - pannello, dimensioni mm 1000 x 1500



8 PROTEZIONE PER TRAPANO A COLONNA

Struttura in acciaio e schermo in materiale plastico antiurto. Regolabile in altezza, con microinterruttore. Cupola Ø mm 180 compresa.

RIP007U - protezione con attacco universale



Grigliati componibili

Di facile messa in opera grazie al semplice sistema di aggancio tra i vari elementi, permettono di realizzare pavimentazioni di qualsiasi misura rendendole antisdruccevoli e isolanti.

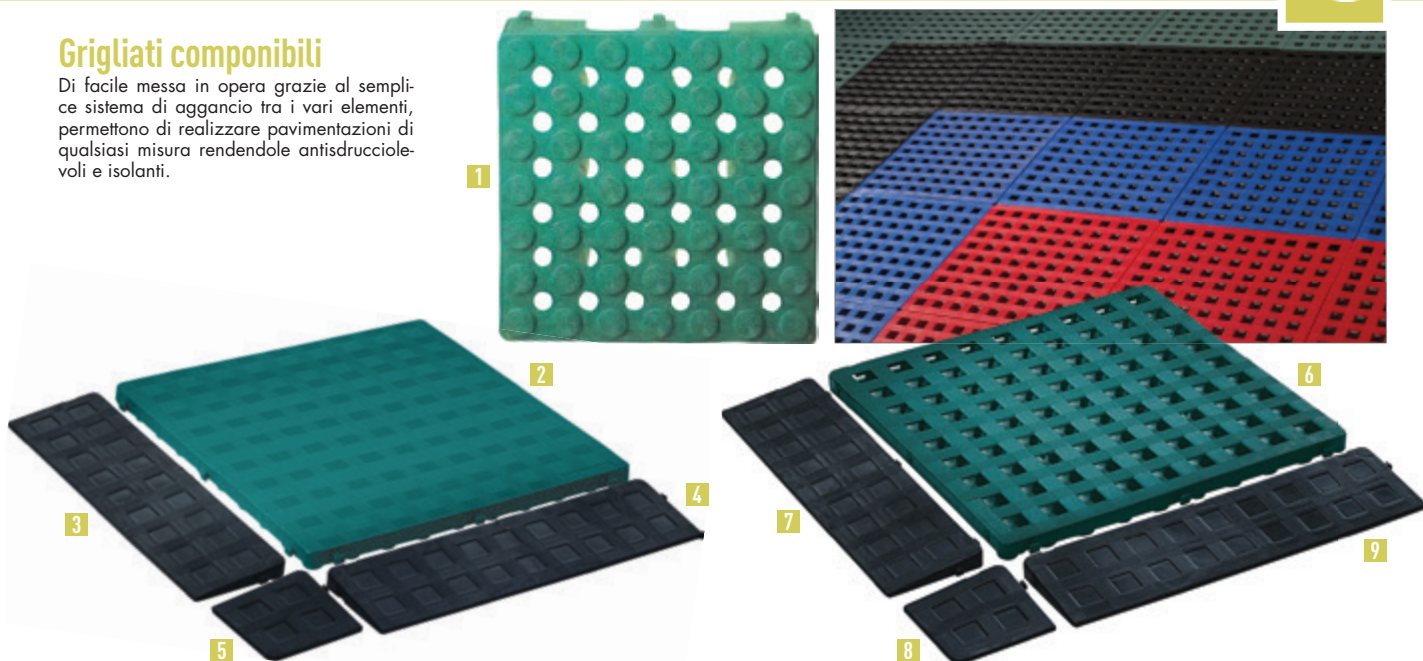

1 SIGMA

In resina speciale antiurto per la pavimentazione di industrie grafiche e meccaniche. Sono in grado di assorbire al massimo le vibrazioni degli impianti e di attutirne i rumori. Ottima resistenza agli acidi e ai liquidi corrosivi. Sopporta carichi alla compressione, senza snervamento, sino a 17 t per m². Angolari non sono fornibili.

PDC502 - lastra, dimensioni mm 500 x 500 x h 50 mm, colore verde

EPSILON PLUS

Pavimento componibile a superficie intera isolante, perfetta aderenza alle superfici. Caratteristiche dielettriche per tensione di scarica 76.000 V. Carico di lavoro sino a 23-30 t per m².

- 2 PDC535** - lastra 500 x 500 x h 25 mm, colore verde
- 3 PDC535AM** - laterale maschio, dimensioni 500 x 130 mm, colore nero
- 4 PDC535AF** - laterale femmina, dimensioni 500 x 130 mm, colore nero
- 5 PDC535A** - angolare, dimensioni 130 x 130 mm, colore nero

EPSILON

Resiste ad acidi, solventi, grassi. Caratteristiche dielettriche per tensioni di lavoro sino a 3.000 V (tensione di scarica 20.000 V). Stampato ad iniezione con resine poliolefiniche opportunamente formulate ed additate. Carico di lavoro sino a 20-25 t per m².

- 6 PDC566** - lastra mm 500 x 500 x 25 h, colore verde. **Altri colori fornibili a richiesta**
- PDC560** - lastra tipo PU mm 500 x 500 x h 25, colore nero. Resistente agli olii emulsionabili, è particolarmente indicata per macchine utensili
- 7 PDC566AM** - laterale maschio 500 x 130 mm, colore nero
- 8 PDC566A** - angolare 130 x 130 mm, colore nero
- 9 PDC566AF** - laterale femmina 500 x 130 mm, colore nero

Pannelli e grigliati in vetroresina

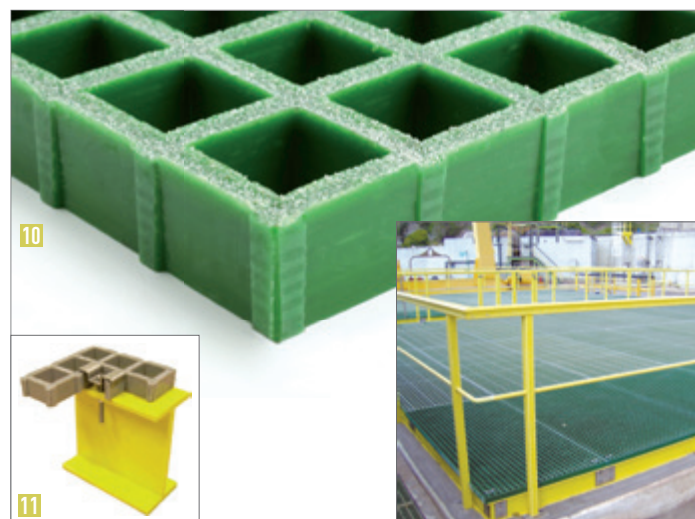

GRIGLIATO IN VETRORESINA

Grigliato in PRFV (Poliestere Rinforzato con Fibre di Vetro) leggero, di facile montaggio e pulizia, con manutenzione limitata. Resistente all'usura è indicato alle industrie con problemi di corrosione. Superficie antisdrucceolo (classificazione R13-V10 norma DIN 51130) assicura aderenza con superficie bagnata, gelata e sporca di grasso. Amagnetico e non conduttore consente ottimo isolamento termico ed elettrico, buona resistenza al fuoco e bassa emissione di fumi. Assicura una resistenza meccanica simile all'acciaio, non si deforma stabilmente con sovraccarichi e può essere tagliato sul posto. I pannelli di grigliato sono composti da maglie di dimensioni 30 x 30 mm, spessore 30 mm. Per il fissaggio utilizzare ferma grigliati idonei (minimo 4 per pannello). A richiesta fornibile in colore grigio e altri formati.

- 10 PDT2010** - pannello grigliato colore verde, dimensioni 1000 x 2000 mm
- 11 PDT2010F** - ferma griglie tipo a "doppia ala" completo di bullone M6 x 60 in AISI 316

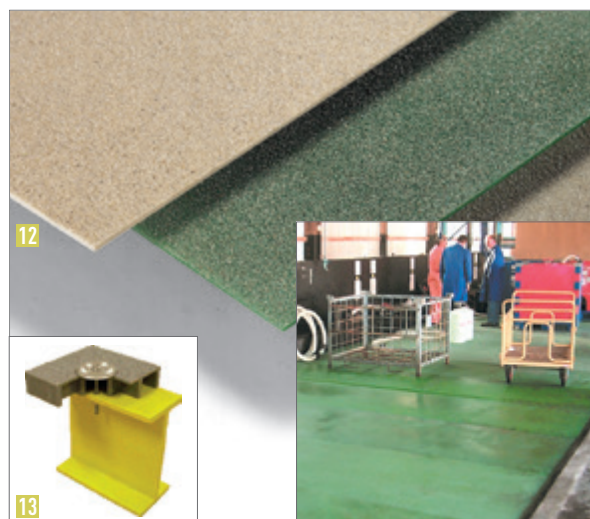

LAMINATO IN VETRORESINA

Pannello di laminato in PRFV (Poliestere Rinforzato con Fibre di Vetro) resistente agli agenti atmosferici, elevata resistenza meccanica. Realizzato accoppiando fibra di vetro Mat e Stuoie intrecciate, in resina standard isofaltica autoestingente. Idoneo per mettere in sicurezza superfici in cemento o con grigliati metallici. Certificazione antisdrucceolo R13 V10-DIN 51160 Il laminato può essere fissato tramite apposite ferma griglie o collanti (non inclusi). A richiesta fornibile anche nella variante colore grigio e in altri formati.

- 12 PDT1020** - pannello di laminato in PRFV colore verde, formato 1200 x 2000 mm, spessore 3 mm (tolleranze: dimensione ± 5 mm, spessore ± 10%)
- 13 PDT1020F** - piastrina fermagriglia in AISI 316 tipo a "calotta" Ø 50 mm, foro Ø 6,5 mm, completa di bullone M6 x 60

A COSA SERVONO I TAPPETI ANTIFATICA?

Rimanere in piedi per più di 4 ore al giorno o camminare in una zona delimitata è la principale causa di stanchezza fisica, mal di schiena, problemi cervicali, mal di testa, male ai piedi, problemi di circolazione, gonfiori agli arti inferiori e costituisce una fonte di rischio di lesioni temporanee e croniche. L'uso dei tappeti antifatica costituisce il metodo più sicuro e semplice per ridurre o addirittura evitare il sorgere di queste problematiche, svolgendo una funzione antifatica, antiscivolo e isolante.

- **FUNZIONE ANTIFATICA:** questa funzione è data dal fatto che la superficie d'appoggio dura di una normale pavimentazione aziendale, viene sostituita da una morbida.
- **FUNZIONE ANTISCIVOLO:** il 20% degli infortuni sul lavoro, in ogni tipo di attività, è dovuto a cadute, causate principalmente da superfici scivolose. Questa linea di tappeti svolge un'azione antifatica e antiscivolo riducendo notevolmente anche questo importante rischio.
- **FUNZIONE ISOLANTE:** la maggior parte dei pavimenti nei locali industriali è in cemento, non isolano dal freddo e dal caldo. Questi tappeti costituiscono un'efficace barriera non solo proteggendo dal freddo e dal caldo ma anche riducendo la trasmissione di rumore e vibrazioni.

Si aggiunge a queste importanti funzioni, anche quella di proteggere i pavimenti da eventuali cadute di attrezzi dai banchi di lavoro salvaguardando gli attrezzi stessi.

BENEFICI AZIENDALI

Un ambiente di lavoro che rispetti le condizioni lavorative crea di conseguenza anche dei benefici aziendali. Pensiamo solo alla funzione antifatica dei tappeti e alla conseguente riduzione della stanchezza dell'operatore che riesce a mantenere un **livello di produttività più stabile** nell'arco della giornata. La **diminuzione dell'assenteismo** è uno degli altri benefici aziendali: l'uso di superfici morbide crea minori sforzi fisici, riducendo così il rischio di lesioni temporanee o croniche e di conseguenza, anche le **spese sanitarie per indennità di malattia e infortunio**. Inoltre un ambiente lavorativo che rispetti e salvaguardi la salute fisica dei lavoratori crea un **miglior clima in azienda**.

LEGENDA

	Antifatica
	Antiscivolo
	Resistenza all'usura
	Flame retardant
	Idrorepellente
	Resistente all'olio

1 ORTHOMAT® DIAMOND

Tappeto ergonomico in PVC a strato singolo per postazioni di lavoro dove si è costretti a mantenere una posizione eretta per interi turni lavorativi. La particolare costruzione a bolle consente il giusto equilibrio, stimola la circolazione riducendo la pressione sui piedi, gambe e schiena. Robusto, per carichi di lavoro da leggeri a medi. Utilizzo in ambienti asciutti. Spessore mm 9, colore nero con strisce laterali gialle.

PDC700 - tappeto Orthomat Diamond in rotolo h 120 cm (specificare larghezza, lunghezza massima 18,3 m)

PDC701 - tappeto Orthomat Diamond, dimensioni cm 60 x 90

PDC702 - tappeto Orthomat Diamond, dimensioni cm 90 x 150

PDC703 - tappeto Orthomat Diamond in rotolo h cm 90 (specificare lunghezza - lunghezza massima fornibile 18,3 metri)



2 ORTHOMAT® RIBBED

Tappeto in PVC per postazione di lavoro, ergonomico a strato singolo, con robusta superficie rigata a coste, idoneo per postazioni di lavoro dove si è costretti a mantenere una posizione eretta per interi turni lavorativi. Per carichi di lavoro da leggeri a medi. Antiscivolo R10 conforme EN13552. **Classe di protezione antincendio (B2) conforme DIN54332/DIN4102.** Colore grigio/giallo, spessore mm 9.

PDC704 - tappeto Orthomat® Ribbed, cm 60 x 90

PDC705 - tappeto Orthomat® Ribbed, cm 90 x 150

PDC706 - tappeto Orthomat® Ribbed in rotolo h cm 90 - specificare larghezza (lunghezza massima 18,3 metri)





1 ORTHOMAT® PREMIUM

Tappetino anti-fatica in PVC a due strati, resistente all'usura. Idoneo per carichi di lavoro da medi a concentrati. Composto da una parte superiore indurita resistente all'usura e uno strato interno in espanso atto ad offrire una comoda attenuazione e scarico. I bordi smussati del tappetino riducono i rischi da inciampo. Colore nero, spessore mm 12.

PDC707 - tappeto Orthomat® Premium, cm 60 x 90

PDC708 - tappeto Orthomat® Premium, m 90 x 150

PDC709 - tappeto Orthomat® Premium in rotolo h cm 90 - specificare larghezza (lunghezza massima 18,3 metri)

PDC710 - tappeto Orthomat® Premium in rotolo h 60 cm - specificare larghezza (lunghezza massima 18,3 metri)

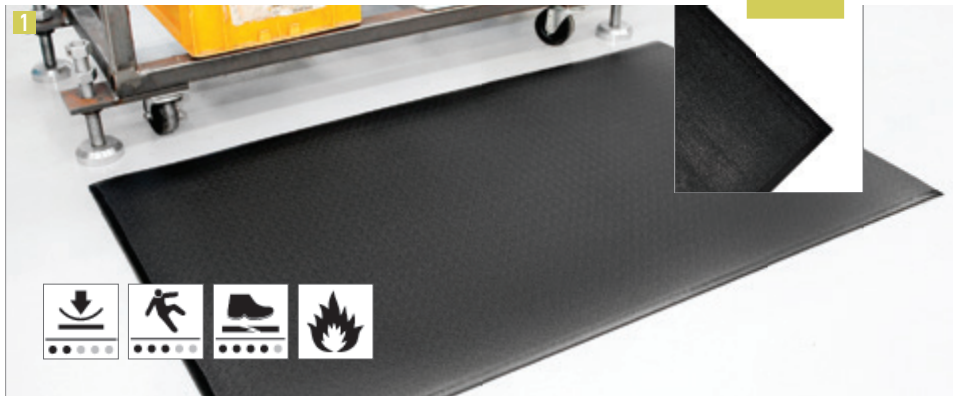

2 DECKPLATE

Pedana con bordi smussati per maggiore sicurezza, resistente all'abrasione ed ai prodotti chimici, concepito specialmente per uso industriale intenso, la base in schiuma offre un'ergonomia superiore. Spessore mm 14. Colore: nero con bordi gialli. Applicazioni: interni adibiti ad uso industriale particolarmente adatto per zone di intenso passaggio pedonale.

PDC490 - pedana Deckplate, cm 60 x 90

PDC491 - pedana Deckplate, cm 90 x 150

PDC492 - pedana Deckplate, cm 90 x 300

PDC493 - pedana Deckplate, cm 90 x 600

PDC494 - pedana Deckplate in rotolo h cm 60 - specificare larghezza (lunghezza massima 18,3 metri)

PDC495 - pedana Deckplate in rotolo h cm 90 - specificare larghezza (lunghezza massima 18,3 metri)



3 DIAMOND TREAD

Pedana di sicurezza ideale per aree di saldatura e per utilizzi industriali gravosi. Superficie ondulata in rilievo, ritardante la fiamma, su base schiuma per svolgere una buona azione antifatica. Resistenza al fuoco classe CFL-S1. Spessore 12,5 mm

PDC604 - tappeto Diamond Tread, cm 60 x 90 spessore 12,5 mm

PDC605 - tappeto Diamond Tread, cm 90 x 150

PDC606 - tappeto Diamond Tread in rotolo h cm 90 - specificare larghezza (lunghezza massima 18,3 metri)



4 SOLID FATIGUE STEP

Pedana realizzata in caucciù molto resistente con elevate caratteristiche defaticanti (fornisce uno strato ammortizzante che riduce notevolmente l'affaticamento). Buone caratteristiche di resistenza a oli e grassi. Le lastre da cm 90 x 90 si incastrano fra loro e permettono la composizione di pedane di qualsiasi dimensione e forma e sono facilmente sostituibili. Ideale per personale che lavora molte ore in posizione eretta. **Spessore mm 16.** Colore nero. Applicazioni ideali: sopporta temperature elevate è quindi indicata per ambienti dove si eseguono operazioni di saldatura o dove vi sia il rischio di fuoriuscita di materiale incandescente.

PDC430 - lastra Solid Fatigue Step, cm 90 x 90

PDC435M - bordo terminale obliquo maschio, colore giallo, mm 75 x 1000

PDC435F - bordo terminale obliquo femmina, colore giallo, mm 75 x 1000



5 FATIGUE-STEP GRIT TOP

Grigliato componibile a incastro con superficie antiscivolo, estremamente robusto per utilizzi gravosi. Realizzato in nitrile offre un'eccellente resistenza a oli e prodotti chimici. La superficie superiore a grani, saldata con carbonio, fornisce un'eccellente aderenza persino in condizioni di pavimentazioni oleose. Fornisce livelli elevati di comfort con un effetto antifatica. Fori aperti per un efficace drenaggio dei liquidi versati. Spessore 18 mm.

PDC470 - lastra Fatigue Step Grit Top, cm 90 x 90,

PDC435M - bordo terminale obliquo maschio, colore giallo, mm 75 x 1000

PDC435F - bordo terminale obliquo femmina, colore giallo, mm 75 x 1000

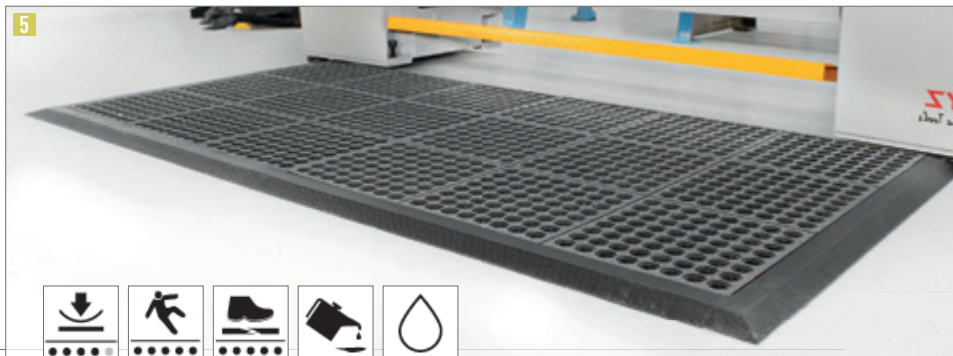



PEDANE E TAPPETI DEFATICANTI

FLEXI DECK

Pedana modulare flessibile in PVC, ideale per il posizionamento in ambienti industriali, umidi o bagnati, facilmente arrotolabile per permettere la pulizia del pavimento. Drenaggio ottimale di liquidi e detriti, eccellente resistenza allo scivolamento. Isola l'utente dal freddo. Spessore mm 13. Colore nero. Grazie alla modularità è possibile coprire aree di ogni dimensione e forma. Fornibile a richiesta nel colore grigio.

- 1 **PDC4059** - pedana Flexi Deck nera, dimensioni cm 30 x 30
- 2 **PDC4050M** - bordo maschio nero per pedana Flexi Deck
- 3 **PDC4050F** - bordo femmina nero per pedana Flexi Deck
- 4 **PDC4050** - angolare nero per Flexi Deck



5 WORKSTATION MAT

Piano di calpestio riposante, allevia i disturbi causati dalla posizione eretta prolungata, alleggerendo la fatica di reni e gambe. Fabbricata in estrusione di PVC con intessitura a maglia larga (mm 20 x 20) per permettere il passaggio dei detriti. La griglia è consegnata con un bordo smussato in colore contrastante. Intreccio in superficie con caratteristiche antiscivolo in presenza di oli/acqua. Facile da pulire con acqua e sapone. Spessore mm 12. Colore nero con bordi gialli. Applicazioni ideali: ambienti industriali in particolare in presenza di macchine utensili.

- PDC415** - pedana Workstation Mat, cm 60 x 120
- PDC416** - pedana Workstation Mat, cm 100 x 150
- PDC417** - pedana Workstation Mat, cm 120 x 180



BUBBLEMAT

Tappeto in gomma naturale per postazioni di lavoro, ergonomico e robusto con superficie a bolle che inducono al movimento e stimolano la circolazione evitando così la sensazione di affaticamento. Per ambienti industriali, buona resistenza agli oli. Colore nero, spessore mm 14.

- 6 **PDC101** - tappeto Bubblemat, cm 60 x 90
- PDC102** - tappeto Bubblemat, cm 90 x 120
- 7 **PDC100C** - tappeto Bubblemat, blocco centrale per composizione a incastro, cm 60 x 90
- 8 **PDC100T** - tappeto Bubblemat, blocco terminale (utilizzabile sia a destra che a sinistra) per composizione a incastro, cm 60 x 90



9 COBA ELITE

Pregiato tappeto Premium ergonomico in poliuretano. Ottima riduzione della pressione sulla schiena, sulle gambe e sui piedi. Affidabile prevenzione degli effetti collaterali dovuti a lunghe fasi lavorative in posizione ferma ed eretta. **Classe di protezione antincendio B1 conforme DIN54332/DIN4102.** Colore nero, spessore mm 15.

- PDC103** - tappeto Cobra Elite, cm 60 x 90
- PDC104** - tappeto Cobra Elite, cm 90 x 120

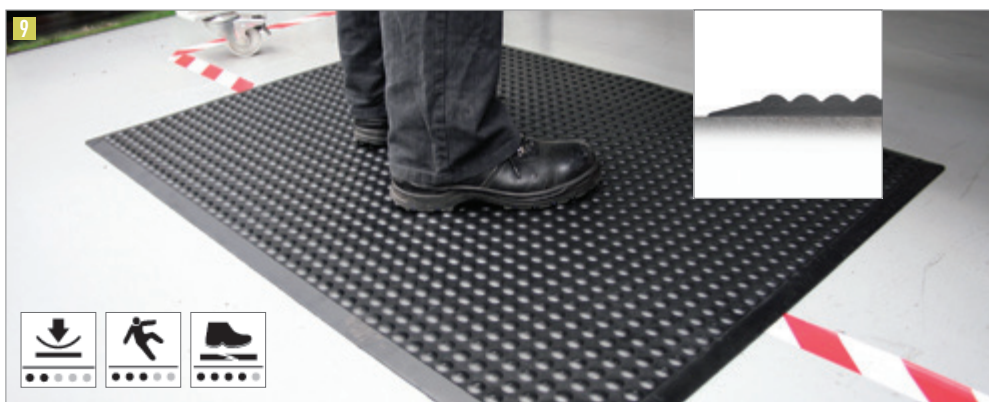

10 COBADOT

Disponibile in due materiali: **Standard** (gomma naturale/**sintetica**) ideale per ambienti industriali e commerciali e **Nitrile** (gomma naturale/**nitrilica**) estremamente resistente a oli, grasso e degradazione chimica. Ampiamente utilizzati per proteggere i pavimenti, offrono spesso anche un aspetto estetico. Superficie a rilievo, elegante, funzionale e antiscivolo. **Versione in nitrile, resistente a oli e grassi, fornibile a richiesta.**

- PDC720** - rotolo in gomma sintetica colore nero, dimensioni 1,2 m x metro lineare, spessore 3 mm (specificare lunghezza, lunghezza massima fornibile 10 m)
- PDC721** - rotolo in gomma sintetica colore nero, dimensioni 1,2 m x metro lineare, spessore 4,5 mm (specificare lunghezza, lunghezza massima fornibile 10 m)

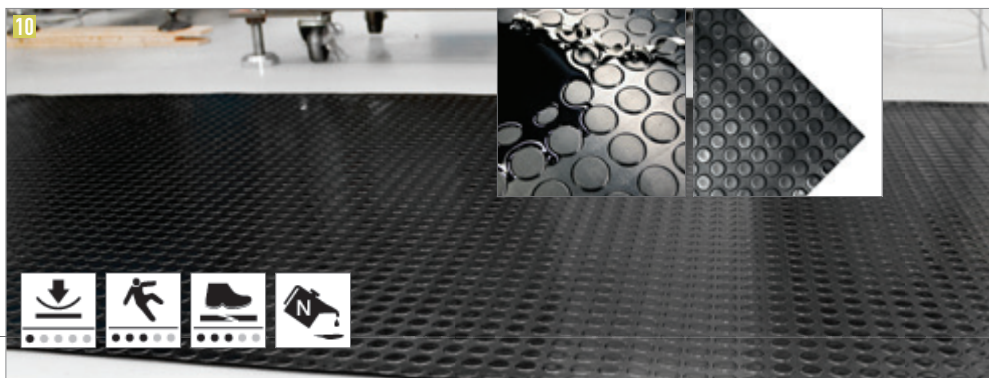



1 TAPPETO RAMPMAT

Economico tappeto anti-fatica forato in resistente in mescola di gomma SBR. Prevenzione efficace dei segni di affaticamento e pericolo di scivolamenti. Bordi smussati per ridurre i rischi da inciampo. Antiscivolo R10 conforme DIN13552. Colore nero, spessore mm 10.

PDC090 - tappeto Rampmat, dimensioni cm 90 x 150

PDC091 - tappeto Rampmat, dimensioni cm 80 x 120



2 COBASTAT KIT

Pedana defaticante robusta e durevole con proprietà di **dissipazione delle cariche elettrostatiche**. Il kit comprende: pedana Cobastat da cm 90 x 150 colore grigio, cavo di messa a terra, spina antistatica con attacco EU e 2 nastri di messa a terra per scarpe (fornito con presa Schuko). Fornibile a richiesta in differenti lunghezze.

PDC602 - kit pedana Cobastat



3 TAPPETINO SOTTOSEDIA CHAIR MAT

Tappetino protettivo in policarbonato trasparente resistente, in due modelli: per pavimenti spessore mm 2 o per tappeti e moquette con dentelli antiscivolo spessore mm 2,5. Antiscivolo, analergico, riciclabile dopo l'uso.

PDC120T - tappetino sottosedia Chair Mat per tappeti e moquette, cm 90 x 120

PDC150T - tappetino sottosedia Chair Mat per tappeti e moquette, cm 120 x 150

PDC120 - tappetino sottosedia Chair Mat per pavimenti, cm 90 x 120

PDC150 - tappetino sottosedia Chair Mat per pavimenti, cm 120 x 150

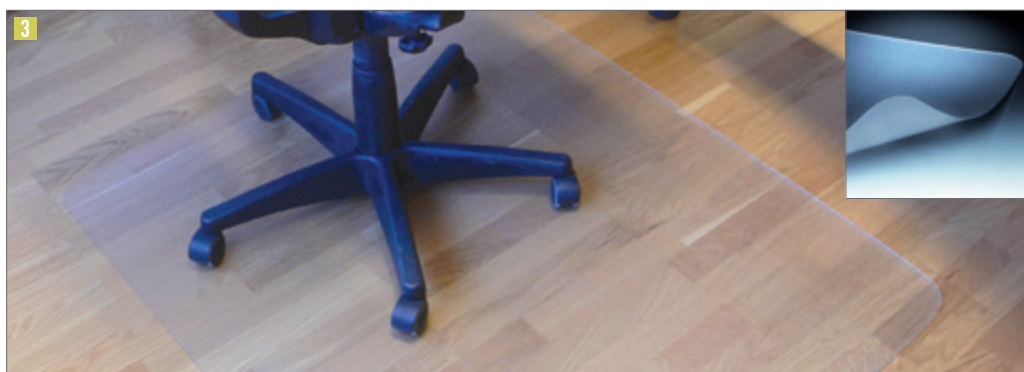

4 TAPPETO ADESIVO ANTIPOLVERE NOMAD™ 4300

3M

Ideale per proteggere tutte le aree in cui la pulizia e l'igiene sono fattori critici. Tappeto anticontraffattante costituito da 40 fogli usa e getta cosparsi di un adesivo batteriostatico sensibile alla pressione. Il foglio rimuove la polvere dalla suola delle scarpe e dalle ruote dei carrelli. Tipiche aree di applicazione: ospedali, laboratori di analisi, impianti di produzione e semiconduttori, industrie elettroniche in genere, industrie farmaceutiche, industrie chimiche, laboratori fotografici, impianti di verniciatura. Spessore ridotto, perfetta adesione al pavimento. Facile da rimuovere e smaltire, non lascia residui sul pavimento.

TPA81794 - tappeto trasparente adesivo antipolvere Nomad™ 4300, m 0,45 x 1,15

5 KNEE SAVER

Riduce il dolore alle ginocchia ed alla zona lombare della colonna vertebrale dovuto ad attività che prevedono il mantenimento prolungato di una posizione inginocchiata. Questa tavoletta è realizzata in PVC e nitrile, per coniugare leggerezza (solo 450 g) e resistenza a diverse sostanze chimiche ed olii. Un pratico incavo sagomato ne permette un agevole trasporto. Colore nero.

PDC4040 - tavoletta cm 53 x 36, spessore mm 25





PEDANA RISCALDANTE E TAPPETI PER AREE A TRAFFICO PEDONALE

! IN FASE D'ORDINE SPECIFICARE SEMPRE IL CONNETTORE DESIDERATO (PDCAREG O PDCAALI).

NEW

È POSSIBILE COLLEGARE IN LINEA FINO A 4 PEDANE

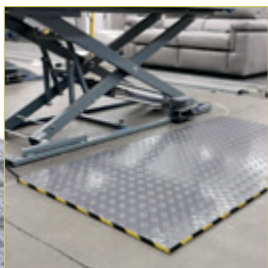

1

- CARATTERISTICHE:**
- CERTIFICAZIONE CE
 - SPESSORE 15 MM
 - FINITURA IN LAMIERA MANDORLATA VERNICIATA
 - GRADO DI PROTEZIONE IPX7
 - ALIMENTAZIONE 230V
 - CONNETTORE STANDARD (PDCAALI) O CONNETTORE CON REGOLATORE D'INTENSITÀ PER CONTROLLO TEMPERATURA PEDANA (PDCAREG)

1 PEDANA RISCALDANTE

Ideale per il riscaldamento localizzato di postazioni di lavoro in capannoni, officine, laboratori e negozi. Utilizzando lo stesso principio del riscaldamento a pavimento (irraggiamento), dona beneficio alle persone che vi stazionano sopra. La pedana va posata sul pavimento senza forarlo e non necessita di manutenzioni essendo priva di caldaia, pompe e circuiti elettrici. La temperatura della pedana può essere gestita tramite un regolatore di intensità che consente di dosare il calore emesso. Range temperatura 0 ~ 70°C. Spessore 15 mm. Portata di carico massima 150 kg/m². Tensione di alimentazione 230V / 50Hz. Grado di protezione IPX7.

- PDCA095** - pedana riscaldante dimensioni 95 x 95 x 1,5 cm, peso kg 15
- PDCA195** - pedana riscaldante dimensioni 195 x 95 x 1,5 cm, peso kg 28,5
- PDCAREG** - connettore con regolatore d'intensità, che consente di dosare il calore emesso
- PDCAALI** - connettore cavo di alimentazione standard (la temperatura della pedana rimane costante)

Tappeti per aree a traffico pedonale



L'inserimento dei tappeti già dalle fasi di progettazione o ristrutturazione offre rilevanti vantaggi economici, funzionali ed estetici. I tappeti proteggono le pavimentazioni, riducono i costi di manutenzione e migliorano la sicurezza dei visitatori. I tappeti NOMAD™ hanno un'innovativa struttura a ricciolo vinilico che si rivela una barriera antisporco estremamente efficace nella protezione delle aree di ingresso. Due linee disponibili: NOMAD™ Terra, indicati per esterni, incavi ed interni; NOMAD™ Acqua, specifici per interni.

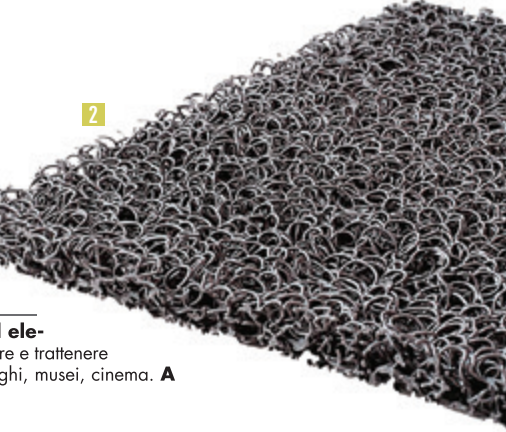
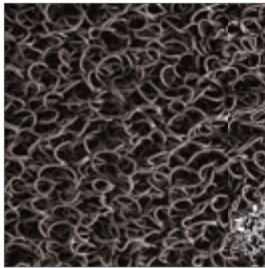
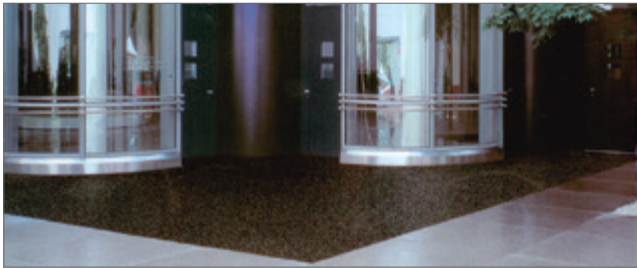

2 TAPPETO NOMAD™ TERRA 8100

Tappeto senza supporto per drenare acqua e sporco. In ricciolo vinilico di elevato spessore, **adatto per aree ad elevato traffico**, specifico per incavi ed esterni come prima barriera antisporco. La sua struttura è in grado di rimuovere e trattenere lo sporco. Spessore totale mm 16. Facile da pulire, personalizzabile. Ideale per edifici pubblici, commerciali, alberghi, musei, cinema. **A richiesta fornibili tappeti di altre dimensioni/colori.**

TPA8115G - tappeto Nomad™ Terra 8100, cm 90 x 150, colore grigio ardesia

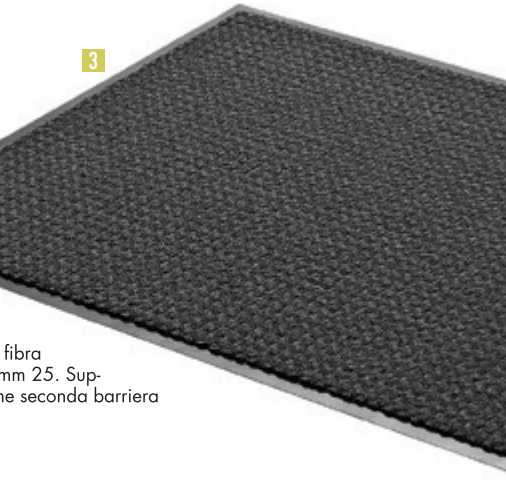
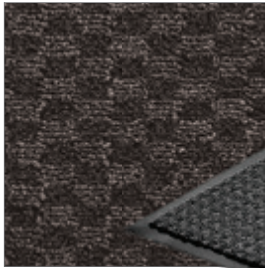
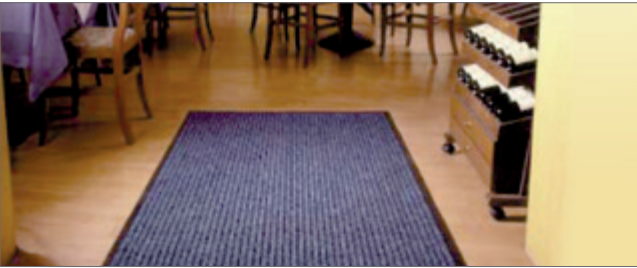

3 TAPPETO NOMAD™ AQUA TESSILE 65

Tappeto **per aree a medio traffico**, specifico per interni. **L'innovativa costruzione a tre strati offre un'ottima capacità di rimozione e ritenzione dell'acqua.** La superficie alterna riccioli a doppia fibra. La fibra spessa cattura lo sporco e quella sottile assorbe e trattiene l'acqua. Spessore totale mm 7,5, larghezza bordatura mm 25. Supporto antiscivolo in PVC senza fralati, autogiacente. Infiammabilità Euroclasse 1350-1. Facile da pulire, ideale come seconda barriera antisporco per uffici, alberghi e ristoranti. **A richiesta fornibili tappeti di altre dimensioni/colori.**

TPA6553G - tappeto tappeto Nomad™ Acqua Tessile 65, disegno a scacchi, cm 90 x 150, colore grigio



GAMMA DI TAPPETI REALIZZABILI CON TESTI, LOGHI E COLORI DIVERSI SU SPECIFICHE RICHIESTE DEL CLIENTE. CONTATTACI PER AVERE MAGGIORI INFORMAZIONI.

TAPPETI PER COMUNICAZIONI PERSONALIZZABILI

Tappeti per aree a medio traffico pedonale, adatta a qualsiasi ambiente, costituiti da riccioli in vinile con capacità di assorbimento acqua, rimozione e trattenimento dello sporco.

- 1 **TPJ4609** - colore grigio, scritte nere, dimensioni cm 120 x 180, peso 6 kg
- 2 **TPJ4615** - colore blu, scritte bianche, dimensioni cm 120 x 180, peso 6 kg
- 3 **TPJ4611** - colore grigio, scritte bianche, dimensioni cm 120 x 180, peso 6 kg
- 4 **TPJ3511** - colore grigio, scritte bianche, dimensioni cm 90 x 150, peso 3,8 kg
- 5 **TPJ3510** - colore grigio, scritte nere, dimensioni cm 150 x 90, peso 3,8 kg
- 6 **TPJ4616** - colore blu, scritte bianche, dimensioni cm 180 x 120, peso 6 kg

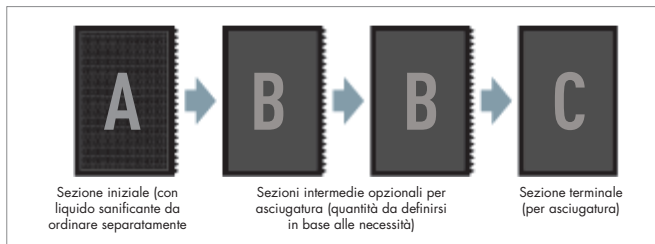

7 TAPPETO SANIFICANTE COMPONIBILE E PERSONALIZZABILE

Questo tappetino di 19 mm di spessore pulisce, igienizza e asciuga le scarpe in un'unica soluzione componibile, è consigliato agli ingressi per evitare contaminazioni. Realizzato in gomma 100% naturale e progettato per resistere alla maggior parte dei prodotti chimici, oltre che alle variazioni di temperatura. Utilizzo consigliati: interno/zone d'accesso, entrate uffici/aree produttive, laboratori, spogliatoi, mense ed ogni luogo dove serve contenere la diffusione di contaminanti. Colore carbone/nero, dimensioni: 91,4 x 105 cm. È possibile acquistare il kit base composto da zona sanificazione (A) + asciugatura (C) e allungarlo a piacere con le zone intermedie opzionali (B). Le zone personalizzabili con loghi, colori e scritte sono la (B) e la (C). Liquido sanificante non compreso nella fornitura.

PDCJ9105C - kit base tappeto sanificante: zona sanificazione (A) + zona asciugatura (C) STANDARD. Dimensioni 91,4 x 105 cm

PDCJ9105P - kit base tappeto sanificante: zona sanificazione (A) + zona asciugatura (C) PERSONALIZZATA. Dimensioni 91,4 x 105 cm

PDCJ950C - zona estensione tappeto sanificante (B) STANDARD per PDCJ9105C (standard) o PDCJ9105P (personalizzato). Dimensioni 91,4 x 50 cm

PDCJ950P - zona estensione tappeto sanificante (B) PERSONALIZZATA per PDCJ9105C (standard) o PDCJ9105P (personalizzato). Dimensioni 91,4 x 50 cm

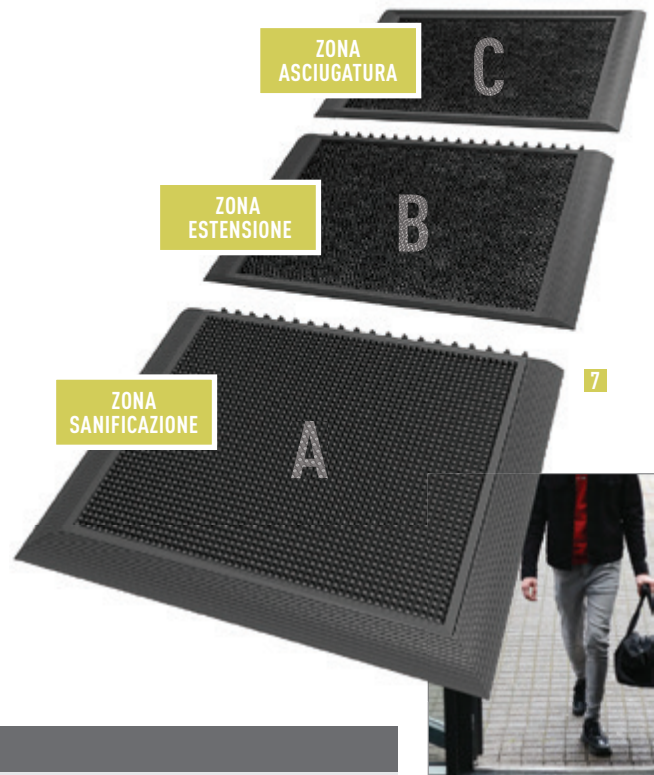

ESEMPI DI TAPPETI PERSONALIZZATI





1 POLSIERA A CINGHIA SINGOLA

Supporta il polso durante il movimento ripetitivo. **Limita i movimenti del polso verso il basso.** Rinforzo brevettato con apertura centrale, per alleviare la pressione sul nervo mediano. Indicatore a "linea rossa" per assicurare una corretta posizione della mano e del polso. Fodera antibatterica, lavabile in lavatrice. Cinturino elastico singolo, chiusura con velcro. Taglie S / M / L / XL.

EDS400R. - polsiera mano destra colore nero

EDS400L. - polsiera mano sinistra colore nero



2 POLSIERA A CINGHIA DOPPIA

Supporta il polso durante il movimento ripetitivo. **Limita i movimenti del polso verso il basso e verso l'alto.** Rinforzo brevettato con apertura centrale, per alleviare la pressione sul nervo mediano. Indicatore a "linea rossa" per assicurare una corretta posizione della mano e del polso. Fodera antibatterica, lavabile in lavatrice. Cinturino elastico doppio, chiusura con velcro. Taglie S / M / L / XL.

EDS402R. - polsiera mano destra colore nero

EDS402L. - polsiera mano sinistra colore nero



EN388:2016
2121X

3 GUANTI ANTIVIBRAZIONI PROFLEX® 9002

Guanti antivibrations certificati "Full-Finger", ideali per applicazioni gravose. Buona presa su utensili e apparecchiature. Chiusura del polso con velcro. **Certificati ANSI S2.73-2014/ISO 10819:2013.**

EDS901 - guanti antivibrations Proflex® colore nero. Taglie disponibili: M / L / XL



4 GOMITIERA IN NEOPRENE

Gomitiera in neoprene perforato e maglia spandex nella piega del gomito. Design pre-curvo e sagomato che fornisce supporto al gomito, preservandolo da disturbi dovuti a movimenti ripetitivi. Taglie disponibili: S / M / L / XL / XXL.

EDS650. - gomitiera in neoprene colore nero



5 GINOCCHIERA IN NEOPRENE

Ginocchiera in neoprene perforato per una maggiore traspirazione e maglia spandex dietro il ginocchio. Cuscinetto anteriore in doppio neoprene e a patella aperta. Design pre-curvo e sagomato che si adatta alla forma naturale del corpo. Taglie disponibili: S / M / L / XL / XXL.

EDS615. - ginocchiera in neoprene colore nero



6 GINOCCHIERE 200

Ginocchiere economiche, super leggere, per essere indossate comodamente tutto il giorno. Imbottitura in co-polimero resistente. Cinturino singolo con chiusura a strappo. Taglia unica regolabile.

EDS221 - coppia di ginocchiere economiche 200 in co-polimero



7 GINOCCHIERE 230

Essenziali per chi deve inginocchiarsi frequentemente, ideali su superfici delicate. Modello in Cordura® con fodera interna in Ultrilure®, antibatterico. Chiusura a gancio. Colore nero, taglia unica regolabile.

EDS230 - coppia di ginocchiere 230 in Cordura®



8 GINOCCHIERE 335

Essenziali per chi deve inginocchiarsi frequentemente, ideali su superfici dure, scivolose o abrasive. Modello dotato di fodera in Ultrilure®, imbottitura in neoprene, calotta in gomma antiscivolo. Colore nero, taglia unica regolabile.

EDS335 - coppia di ginocchiere 335 con calotta antiscivolo



9 GINOCCHIERE 355

Con sistema a gel iniettato e schiuma in PU per maggiore comfort. Calotta in plastica antiscivolo. Cinturino superiore elastico, cinturino inferiore palmato. Taglia unica regolabile.

EDS355 - coppia di ginocchiere 355 colore nero



LE TAGLIE DEI SUPPORTO LOMBARI CORRISPONDONO A: S (VITA DA 64 A 76 CM), M (VITA DA 76 A 86 CM), L (VITA DA 86 A 97 CM), TAGLIA XL (VITA DA 97 A 107 CM).



1



2



3

VERSIONE ECONOMICA CON SUPPORTO IN MATERIALE FLESSIBILE



TECNOLOGIA BREVETTATA STICKY FINGERS® PER UN MAGGIORE SUPPORTO.



TECNOLOGIA BREVETTATA STICKY FINGERS® E DESIGN A "V" PER UN SOSTEGNO CONTINUO.



1 SUPPORTO LOMBARE 100

Versione economica, in tessuto con fibre di gomma che permettono al supporto di rimanere in posizione, rivestita in tessuto Spandex® per favorire la traspirazione. Bretelle elastiche regolabili. Taglie: dalla S alla XL.

EDS100. - supporto lombare modello 100

2 SUPPORTO LOMBARE 1100

Realizzato con fibre in gomma abbinata alla tecnologia Sticky Fingers® a garanzia di sostegno e corretta posizione, rivestito in tessuto Spandex® per favorire la traspirazione. Bretelle elastiche regolabili. Taglie: dalla S alla XL.

EDS110. - supporto lombare modello 1100

3 SUPPORTO LOMBARE 2000SF

Realizzato con fibre in gomma abbinata alla tecnologia Sticky Fingers® rivestito in leggero tessuto Spandex® per favorire la traspirazione. Design tagliato a "V", per garantire sostegno continuo e corretta posizione. Bretelle elastiche regolabili. Taglie: dalla S alla XL.

EDS200. - supporto lombare modello 2000SF



RICHIEDI UN PREVENTIVO!

4 ESOSCHELETRO - DISPOSITIVO DI ASSISTENZA AL MOVIMENTO

Muscle Suit Every è un dispositivo assistivo creato per aiutare tutte le persone a vivere uno stile di vita sano. Leggero (pesa solo 3,8 kg), semplice e potente, alleggerisce il carico sulla schiena mentre si lavora, aiutando nei lavori pesanti di ogni giorno. Assiste i movimenti fornendo fino a 25,5 kg di forza ausiliaria. Facile da indossare, non richiede abilità specifiche nell'utilizzo. Il dispositivo funziona solo con la pressione dell'aria. Non necessita di elettricità ed è utilizzabile senza limiti di tempo.

ESO001 - dispositivo di assistenza al movimento



ATEX

ETICHETTE D'IDENTIFICAZIONE

Le etichette d'identificazione sono idonee per l'identificazione generica (targhe dati, inventari etc).
Possono essere personalizzate con dati societari, loghi, codici a barre, numerazione progressiva e non
(indicare il tipo di barcode se necessario e inviare un file formato bitmap o jpg per la personalizzazione).
Se hai altri dubbi, contattaci per un preventivo e saremo lieti di aiutarli!

**CONTATTACI
PER UN
PREVENTIVO!**





1

SI ROMPONO IN PICCOLI PEZZI QUANDO SI CERCA DI STACCARLE!



1 ETICHETTE DISTRUTTIBILI INCISE LASER

Etichette in materiale acrilico a doppio strato incise laser (i dati rimangono indelebili nel tempo). Resistono a temperature tra -50°C e +270°C. Retro adesivo acrilico permanente. **Si rompono in piccoli pezzi** quando si cerca di staccarle. Resistono a prodotti chimici, solventi, alte temperature e intemperie. Fornite in multipli di 100 etichette, minimo ordinabile 300 pezzi.

Colori: **S** grigio (scritta nera) **W** bianco (scritta nera)
N nero (scritta bianca) **Y** giallo (scritta nera)
G verde (scritta nera) **R** rosso (scritta nera)
B blu (scritta bianca)

- ELAS1.** - etichette distruttibili mm 40 x 20
- ELAS2.** - etichette distruttibili mm 50 x 20
- ELAS3.** - etichette distruttibili mm 65 x 20
- ELAS4.** - etichette distruttibili mm 65 x 30
- ELAS5.** - etichette distruttibili mm 75 x 25
- ELASN** - spese di impianti per testi, codici a barre, numeri
- ELASL** - spese di impianti per loghi o simboli grafici



2



2 TARGHE IN ALLUMINIO CON INCISIONE LASER

Targhe in alluminio spessore 0,5 mm con incisione laser per una **completa indelebilità delle scritte**. Alta resistenza alle abrasioni, sollecitazioni meccaniche, agenti chimici, solventi, diluenti. Alto contrasto nella leggibilità in particolare modo codici a barre. Fornibili a richiesta con retro adesivo. Minimo ordinabile 200 pezzi.

Colori: **N** nero **R** rosso **B** blu

- ELAS1.** - targa in alluminio mm 40 x 20
- ELAS2.** - targa in alluminio mm 55 x 25
- ELAS3.** - targa in alluminio mm 60 x 20
- ELAS4.** - targa in alluminio mm 75 x 32
- ELAS5.** - targa in alluminio mm 100 x 32
- ELASN** - spese di impianti per testi, codici a barre, numeri
- ELASL** - spese di impianti per loghi, simboli grafici
- ELASAD** - retro adesivo al cm²



3



3 TARGHE IN ACCIAIO CON INCISIONE LASER

Targhe in acciaio inox 304, spessore 0,5 mm con incisione laser. Alta resistenza ad abrasioni, sollecitazioni meccaniche, agenti chimici, solventi, diluenti, maggiore resistenza alle alte temperature. Fornibili a richiesta con retro adesivo. Minimo ordinabile 200 pezzi.

- ELAS11** - targa in acciaio mm 40 x 20
- ELAS12** - targa in acciaio mm 55 x 25
- ELAS13** - targa in acciaio mm 60 x 20
- ELAS14** - targa in acciaio mm 75 x 32
- ELAS15** - targa in acciaio mm 100 x 40
- ELASN** - spese di impianti per testi, codici a barre, numerazioni
- ELASL** - spese di impianti per loghi o simboli grafici
- ELASAD** - retro adesivo al cm²

i ETICHETTE PERSONALIZZABILI CON DATI SOCIETARI, LOGHI, CODICI A BARRE, NUMERAZIONE PROGRESSIVA E NON. INDICARE IL TIPO DI BARCODE, SE NECESSARIO ED INVIARE UN FILE IN FORMATO .DWG, BITMAP O JPEG PER LA PERSONALIZZAZIONE. INVIARE FILE IN .XLS PER LA NUMERAZIONE NON CONSECUTIVA.



4

4 TARGHE IN ALLUMINIO SERIGRAFATE

Targhe serigrafate in alluminio preverniciato 5/10, colore bianco, argento o giallo stampate a 1 o 2 colori. Protezione con film plastico rimovibile. Stampa realizzata con inchiostri bicomponenti cotti in forni ad aria calda. In questo modo la serigrafia resiste a temperature comprese tra i -20°C e i +90°C, e non viene intaccata da alcol, lubrificanti, carburanti e detergenti vari. Con fori e angoli arrotondati. A richiesta fornibili con retro biadesivo industriale (aggiungere la lettera A dopo il codice). Minimo ordinabile 100 pezzi. Colori: **W** bianco **S** argento **Y** giallo

- PMS1.** - targa serigrafata, mm 30 x 18 (b x h)
- PMS2.** - targa serigrafata, mm 40 x 20 (b x h)
- PMS3.** - targa serigrafata, mm 57 x 32 (b x h)
- PMS4.** - targa serigrafata, mm 70 x 40 (b x h)
- PMS5.** - targa serigrafata, mm 100 x 60 (b x h)
- PMT1** - spese impianti 1 colore
- PMT2** - spese impianti 2 colori

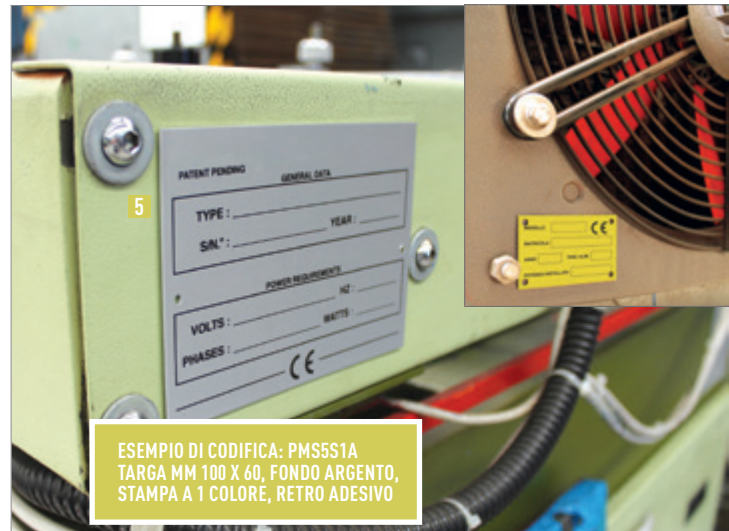

5

ESEMPIO DI CODIFICA: PMS5S1A
 TARGA MM 100 X 60, FONDO ARGENTO,
 STAMPA A 1 COLORE, RETRO ADESIVO

5 TARGHE IN ALLUMINIO ANODIZZATO CON INCHIOSTRI PER ASSORBIMENTO

Targhe in alluminio anodizzato 5/10, stampate con inchiostri per assorbimento, per una **stampa assolutamente indelebile**. Ideali in situazioni dove sia richiesta una particolare resistenza a: sfregamento continuo, usura, abrasione, acidi, salsedine. Con fori e angoli arrotondati, possono essere stampate a 1 colore (no colori RAL o Pantone). A richiesta fornibili con retro biadesivo industriale (aggiungere la lettera A dopo il codice). Minimo ordinabile 100 pezzi.

- PMO1.** - targa in alluminio anodizzato mm 30 x 18 (b x h)
- PMO2.** - targa in alluminio anodizzato mm 40 x 20 (b x h)
- PMO3.** - targa in alluminio anodizzato mm 57 x 32 (b x h)
- PMO4.** - targa in alluminio anodizzato mm 70 x 40 (b x h)
- PMO5.** - targa in alluminio anodizzato mm 100 x 60 (b x h)
- PMT1** - spese impianti 1 colore



ASTE MILLIMETRATE E TARGHETTE IN POLIESTERE



A RICHIESTA FORNIBILI ASTE GRADUATE FINO A 10 METRI (5 SPEZZONI DA 2 METRI COLLEGABILI FRA LORO).

1 ASTA GRADUATA VERTICALE

Strumenti di misurazione professionale per cisterne, serbatoi, bacini di contenimento, silos etc. In alluminio preverniciato spessore mm 0,5, altezza mm 25, gradazione serigrafata ogni centimetro (settori da 10 cm fondo bianco/numeri neri alternati con settori fondo nero/numeri bianchi). Fornite con biadesivo 3M applicato sul retro.

AGV2000 - asta graduata da 0 a 2000

2 ASTE MILLIMETRATE ORIZZONTALI

Strumenti di misurazione professionale per macchine utensili. Realizzate in alluminio preverniciato spessore mm 0,5, altezza mm 11, serigrafate con inchiostri bicomponenti cotti in forni ad aria calda a 180°C per 30/45 minuti. Fornite con biadesivo 3M applicato sul retro. A richiesta fornibili aste millimetriche con numerazione verticale e di diverse lunghezze (fino a 10.000 mm).

AO... - asta millimetrica orizzontale



ASTE MILLIMETRATE ORIZZONTALI DESTRE



AOD250 - asta millimetrica da 0 a 250 mm



AOD500 - asta millimetrica da 0 a 500 mm



AOD1000 - asta millimetrica da 0 a 1000 mm



AOD2000 - asta millimetrica da 0 a 2000 mm



AOD4000 - asta millimetrica da 2000 a 4000 mm

ASTE MILLIMETRATE ORIZZONTALI SINISTRE



AOS250 - asta millimetrica da 250 a 0 mm



AOS500 - asta millimetrica da 500 a 0 mm



AOS1000 - asta millimetrica da 1000 a 0 mm



AOS2000 - asta millimetrica da 2000 a 0 mm



AOS4000 - asta millimetrica da 4000 a 2000 mm



3 TARGHETTE IN PVC AD ALTA ADESIVITÀ

Targhette in PVC ad alta adesività, ottima adesione anche su superfici ruvide. **Spessore 0,65 mm**. Per l'identificazione di pannelli, switch, pulsanti, targhe dati, identificazione generica, ecc. **Efficace alternativa alle targhette incise**. Temperatura di utilizzo: da -40°C a +100°C. Buona resistenza a sostanze chimiche, alcool e idrocarburi. Resistono ad abrasione, raggi UV ed intemperie. Fornite in multipli di 100 etichette, minimo ordinabile 300 pezzi.

EBPVCS1 - targa in PVC ad alta adesività, mm 27 x 18 (b x h). Colori: **N** nero (scrittura bianca) **S** argento (scrittura nera)

EBPVCS2 - targa in PVC ad alta adesività, mm 48 x 19 (b x h). Colori: **N** nero (scrittura bianca) **S** argento (scrittura nera) **Y** giallo (scrittura nera)

EBPVCS3 - disco in PVC ad alta adesività Ø mm 60, con protezione in PVC trasparente ad alto spessore, minimo ordinabile 10 pezzi

i **ETICHETTE PERSONALIZZABILI CON DATI SOCIETARI, LOGHI E NUMERAZIONE PROGRESSIVA. INDICARE IL TIPO DI BARCODE SE NECESSARIO, ED INVIARE UN FILE FORMATO BITMAP O JPG PER LA PERSONALIZZAZIONE.**



CBC18723



CBC28823



CBC39623



CBC18724



CBC28824



CBC39723



CBC18725



CBC28825



CBC39823



CBC18726



CBC28826



CBC39923



CBC18727



CBC28827



CBC40023

LEGENDA COLORI

■ anno 2023	■ anno 2026
■ anno 2024	■ anno 2027
■ anno 2025	■ anno 2028



I BOLLINI DATARIO SONO PERSONALIZZABILI CON LOGHI, COLORI E DIMENSIONI DIVERSE. CONTATTACI PER UN PREVENTIVO!



1 BOLLINI DATARIO IN PVC AD ALTA ADESIVITÀ

Bollini in PVC ad alta adesività, con pellicola protettiva trasparente anti UV. Resistenza ai solventi: buona, applicato su acciaio inossidabile ed esposto a oli, grassi, solventi alifatici, alcool. Diametro mm 25. Confezione da 5 fogli (10 bollini per foglio). I bollini possono essere punzonati con l'apposita punzonatrice.

CBC... - confezione da 5 fogli (10 bollini datario Ø mm 25 per foglio)

2 PUNZONATRICE

Per bollini datario: pratica fori triangolari sino a 1,5 mm di spessore.

EBP65 - punzonatrice in acciaio nichelato

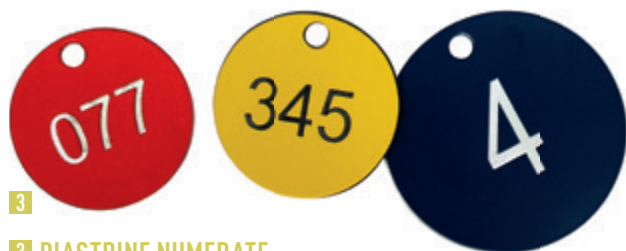

3

3 PIASTRINE NUMERATE

Piastrine in trafolite bistrato incise pantografo, numerate progressivamente da 1 a 100 e fornite in lotti da 25. Spessore 1,5 mm. A richiesta altre misure e possibilità di personalizzazione. Colori:

- W bianco (scritta nera)
- N nero (scritta bianca)
- Y giallo (scritta nera)
- G verde (scritta bianca)
- R rosso (scritta bianca)

DIMENSIONI PIASTRINE

CODICE	DIAMETRO	NUMERAZIONE
PN2525.	25 mm	1 - 25
PN2550.	25 mm	26 - 50
PN2575.	25 mm	51 - 75
PN25100.	25 mm	76 - 100
PN4025.	40 mm	1 - 25
PN4050.	40 mm	26 - 50
PN4075.	40 mm	51 - 75
PN40100.	40 mm	76 - 100





Pellicole per vetri

Servizio di fornitura e posa in opera a regola d'arte di pellicole per vetri da esterni e da interni, per risolvere problemi collegati all'irraggiamento solare, alla privacy, alla sicurezza e all'estetica:

- **Pellicole antisolari:** per la protezione dal sole e dal calore derivante dall'irraggiamento.
- **Pellicole anti-UV:** per la protezione dai raggi-UV, responsabili della decolorazione e deperimento di merci e oggetti
- **Pellicole di sicurezza:** per la messa a norma in sicurezza delle superfici vetrate con adeguamenti alle normative UNI 7697, Ex 626/94, 81/2008 e EN 12600.
- **Pellicole decorative:** utilizzate per migliorare l'estetica degli ambienti interni o per personalizzazioni.

LE NOSTRE SOLUZIONI VENGONO SEMPRE PERSONALIZZATE SULLA BASE DELLE TUE ESIGENZE. CONTATTACI PER UN PREVENTIVO!



1 PELLICOLE ANTISOLARI

La pellicola antisolare protegge dal calore e dai raggi-UV, filtrando fino all'80% l'energia solare. Ciò consente un risparmio energetico sino al 50% permettendo una significativa diminuzione di temperatura sino a un massimo di 10°C.



2 PELLICOLE ANTI-UV

La pellicola, disponibile perfettamente trasparente o leggermente colorata, blocca il 99% dei dannosi raggi UV e protegge con efficacia gli arredi, le merci e le opere d'arte.



3 PELLICOLE DI SICUREZZA

La pellicola fa in modo che, in caso di rottura, il vetro non si frantumi ma che rimanga fondamentale nella sua sede se pur rotto e deformato, salvaguardando l'incolumità di oggetti e persone.



4 PELLICOLE DECORATIVE

Utilizzate per migliorare l'estetica e la privacy degli ambienti o personalizzazioni, come la realizzazione di loghi aziendali su superfici vetrate interne ed esterne.

SEGNALETICA STRADALE E CANTIERISTICA

SEGNALETICA DI PERICOLO, DIVIETO E OBBLIGO	278-280
CROCI DI SANT'ANDREA	279
PANNELLI INTEGRATIVI AI SEGNALE TRIANGOLARI E CIRCOLARI	281
SEGNALETICA UTILE PER LA GUIDA E VARI	282
SEGNALETICA DI INDICAZIONE, DIREZIONE E PER AGRITURISMI	283
SEGNALETICA TURISTICA E DI INFORMAZIONE	284-285
TARGHE VIARIE, DI LOCALITÀ E DELINEATORI DI CURVA	285
SEGNALETICA MOBILE E PER CANTIERI TEMPORANEI	286-287
SEGNALETICA PER CANTIERI IN POLIONDA	288-289
KIT CAVALLETTI E CAVALLETTI PORTA SEGNALE	290-291
STAFFE, NASTRI, FASCETTE, COLLARI E KIT DI FISSAGGIO	292-293
PALI, SOSTEGNI, PICCHETTI E RETI DA CANTIERE	293
DELIMITATORI, DELINEATORI E SACCHI ZAVORRA	294
BASI, DISSUASORI DI SOSTA E ARTICOLI PER MOVIERI	295
TRANSENNE COMPONENTI, CATENE, PALETTI, COLONNINE E BASI	296-299
SISTEMI DI DELIMITAZIONE AREE E PIASTRELLE TATTILI	300-301
BARRIERE, TRANSENNE SAFE IN®, QUADRILATERI E PANNELLI DI SEGNALE	302-306
DISPOSITIVI ANTISOSTA E ARCHETTI PARAPEDONALI	307-308
BARRIERE NEW JERSEY, DELINEATORI, CORDOLI E DELIMITATORI DI CORSIA	309
CONI SEGNALETICI, DELINEATORI E ACCESSORI	310-311
RALLENTATORI DI VELOCITÀ E PROFILI DI DELIMITAZIONE	312-313
RAMPE PASSACAVI	314-315
PARACOLPI, ANGOLARI, PROFILI E BARRE DI DELIMITAZIONE	316
DELIMITAZIONE AREE PARCHEGGI E BATTIRUOTA	317
PARACOLPI PER BANCHINE, RAMPE E PASSERELLA PEDONALE	318
ARTICOLI PER AREE CICLABILI, CORDOLI, DISSUASORI E ROTONDE IN GOMMA	319
SPECCHI STRADALI E DI SORVEGLIANZA	320-321
MANICHE A VENTO, BARRETTE LUMINOSE, BANDIERE E ARTICOLI SCIOGLINEVE	322-323
PROIETTORI LED, IMPIANTI SEQUENZIALI SENZA FILI, CATADIOTTRI E MARKER STRADALI	324-325
LAMPADINE DA CANTIERE, TORCE A VENTO E A LED, MISURATORE STRADALE	326
KIT SEGNALETICO PER PRONTO INTERVENTO, KIT ADR E TRIANGOLO AUTO FERMA	327
SEGNALE E TRASPORTO DI MERCI PERICOLOSE	328-333
CALZATOIE E ARTICOLI PER CAMION	334



GUIDA ALLA SCELTA DEI MATERIALI



ALLUMINIO

Lamiera di alluminio con titolo di purezza non inferiore al 99,5%, spessore 2,5 mm, scotolatura perimetrale di rinforzo, attacchi universali a corsoio saldati o rivettati sul retro. Tolleranze: $\pm 0,25$ mm.



ACCIAIO

Lamiera acciaio di prima scelta, spessore 1 mm laminata a freddo, scotolatura perimetrale di rinforzo ottenuta con stampaggio a freddo della lamiera, attacchi universali a corsoio saldati o rivettati sul retro. Tolleranze: $\pm 0,14$ mm.

VERNICIATURA

La verniciatura per i segnali in ferro e in alluminio viene eseguita con speciali polveri poliestere a forno, previa preparazione del grezzo (sgrassaggio, lavaggio e fosfatazione, lavaggio e passivazione, asciugatura, mano di primer per alluminio).

RIFRANGENZA

Il nuovo Codice della Strada prescrive che tutti i segnali debbano essere in esecuzione rifrangente con caratteristiche colorimetriche, fotometriche specifiche per i diversi utilizzi. Le caratteristiche prestazionali sono contenute nella norma UNI EN 12899-1:2008. Tutti i segnali stradali sono pertanto prodotti mediante applicazione di pellicole retroriflettente di classe RA1 (ex classe 1 a normale risposta luminosa) o di classe R2 microprismatica (ex classe 2 ad alta risposta luminosa). Le pellicole riportano impressa la marcatura **CE** prevista dal CPR 305/2011.

MARCATURA CE

Secondo il Regolamento prodotti da costruzione 305/2011, il cartello deve essere marcato CE e prevedere necessariamente una dichiarazione di prestazione (DOP) che indichi il modello e le sue prestazioni secondo quanto previsto dalle norme tecniche armonizzate. Secondo la norma UNI EN 12899-1:2008, la fornitura del segnale con marcatura CE deve comprendere anche i fissaggi che sono oggetto di verifica nell'ambito delle prove iniziali di tipo.



MARCATURA CE

CORREDATI DI FISSAGGI E DOP

COMPONENTI



SEGNALE STRADALE CE

=



FACCIA A VISTA

+



PANNELLO (supporto con fissaggi)



+



DOCUMENTI

La sostituzione dei fissaggi (staffa, contro staffa e bulloni) forniti dal costruttore con altri non conformi o il montaggio senza uno dei fissaggi forniti equivale ad una manomissione del prodotto ed invalidano la certificazione del prodotto.

Come da norma, la fornitura con marcatura **CE** deve comprendere anche i fissaggi che sono parte integrante del segnale e sono oggetto di verifica nell'ambito delle prove iniziali di tipo e le cui prestazioni sono previste nella marcatura **CE**. Pertanto il cartello oltre ad essere marcato **CE** e obbligatoriamente fornito di fissaggi a corredo, deve prevedere necessariamente una Dichiarazione di Prestazione (DOP) che indichi il modello e le sue performance. In pratica il fornitore dei pannelli deve aver realizzato le prove iniziali di tipo compresi i fissaggi e quindi tali fissaggi devono poi essere forniti unitamente ad altri componenti (segnale + sostegno).



DOP (DECLARATION OF PERFORMANCE)

La **DOP** (Declaration of Performance) è la **dichiarazione di prestazione** che deve contenere le caratteristiche ed i requisiti essenziali dei cartelli. Le caratteristiche identificano i materiali e le dimensioni comprensive di resistenza alla corrosione, mentre i requisiti identificano le caratteristiche di visibilità cromatiche (CR1/CR2 - B1/B2), di retro riflessione (RA1 - RA2), la durabilità, il tipo di aggancio e la resistenza ai carichi orizzontali che nel caso del **valore nominale di azione al vento può arrivare fino a WL7**. DOP, istruzioni di montaggio e manutenzione compongono la **documentazione standard che accompagna tutti i nostri cartelli**. Ogni singolo cartello riporta nella marcatura **anche il lotto di produzione**.

Dop Declaration of Performance



I segnali stradali raffigurati nel presente catalogo sono per dimensioni, figure e caratteristiche tecniche conformi a quanto stabilito dal Nuovo Codice della Strada (D. Lgs 30 Aprile 1992 n° 285) e dal Regolamento di attuazione del Nuovo Codice della Strada (D.P.R. 16 Dicembre 1992 n°495) e smi. I cartelli sono certificati secondo quanto previsto della Direttiva Prodotti da Costruzione e successivo Regolamento Prodotti da Costruzione 305/2011.



SEGNALI DI DIVIETO E DI OBBLIGO

MARCATURA CE
CORREDATI DI FISSAGGI E DOP

DIMENSIONI DEI DISCHI (cm)

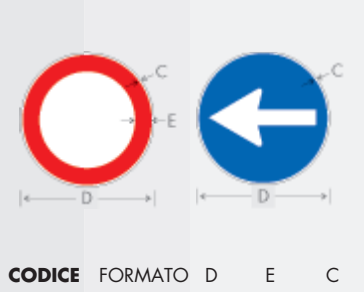

CODICE	FORMATO	D	E	C
...24...	Piccolo	40	5	0,8
...26...	Normale	60	7,5	1
...29...	Grande	90	11	1,5

MATERIALI

CODICE	DESCRIZIONE DEI MATERIALI
FLR.....	Lamiera scatorata, pellicola rifrangente CE (classe RA1)
FLH.....	Lamiera scatorata, pellicola rifrangente CE (classe R2)
FAR.....	Alluminio scatorato, pellicola rifrangente CE (classe RA1)
FAH.....	Alluminio scatorato, pellicola rifrangente CE (classe R2)

COME COMPORRE IL CODICE



! TUTTI I SEGNALI SONO DISPONIBILI IN LAMIERA SCATORATA O IN ALLUMINIO SCATORATO NEL FORMATO E CON PELLICOLA RIFRANGENTE DEL TIPO INDIVIDUABILE DAL CODICE INDICATO SOTTO OGNI SINGOLO ARTICOLO. ALTRI FORMATI O UNA DIVERSA FINITURA RIFRANGENTE FORNIBILI A RICHIESTA.

⚡ ELEVATA RESISTENZA E DURATA DEI MATERIALI. VEDI PAGINA 276.



F.R 260041
dare precedenza nei sensi unici alternati



F.R 260046
divieto di transito



F.H 260047 ■
F.R 260047
senso vietato



F.H 260048 *
divieto di sorpasso



F.R 261049
distanza minima obbligatoria



F.H 260050xx ■
F.R 260050xx
limite massimo di velocità (xx=km/h)



F.R 260051
divieto di segnalazioni acustiche



F.H 260052 *
divieto di sorpasso per i veicoli superiori a 3,5 t a pieno carico



F.R 260053
transito vietato ai veicoli a trazione animale



F.R 260054
transito vietato ai pedoni



F.R 260055
transito vietato ai velocipedi



F.R 260056
transito vietato ai motocicli



F.R 260057
transito vietato ai veicoli a braccia



F.R 260058
transito vietato a tutti gli autoveicoli



F.R 260059
transito vietato agli autobus



F.R 260060 A
transito vietato ai veicoli superiori a 3,5 t a pieno carico



F.R 261060 B
transito vietato ai veicoli superiori a ... t a pieno carico



F.R 260061
transito vietato ai veicoli a motore trainanti un rimorchio



F.R 260062
transito vietato alle macchine agricole



F.R 262063
transito vietato ai veicoli che trasportano merci pericolose



F.R 262064 A
transito vietato ai veicoli che trasportano prodotti esplosivi e/o infiammabili



F.R 262064 B
transito vietato ai veicoli che trasportano prodotti suscettibili di contaminare l'acqua



F.R 262065
transito vietato ai veicoli aventi larghezza superiore a ... metri



F.R 262066
transito vietato ai veicoli aventi altezza totale superiore a ... metri



F.R 261067
transito vietato ai veicoli aventi lunghezza totale superiore a ... metri



F.R 262068
transito vietato ai veicoli aventi una massa superiore a ... t



F.R 261069
transito vietato ai veicoli aventi una massa per asse superiore a ... t



F.R 260070
via libera



F.R 260071 xx
fine limitazione di velocità (xx=km/h)



F.R 260072
fine del divieto di sorpasso

* Segnale obbligatorio con pellicola rifrangente **CE** (classe R2).

■ Segnale consigliato con pellicola rifrangente **CE** (classe R2).



F.R. 260073
fine del divieto di sorpasso
per veicoli superiori a 3,5 t



F.R. 260074
divieto di sosta



F.R. 260075
divieto di fermata



F.R. 260096
ALT - Dogana



F.R. 260098
ALT - Polizia



F.R. 260099
ALT - Stazione



F.H. 260080 A ■
F.R. 260080 A
direzione obbligatoria diritto



F.H. 260080 ■
F.R. 260080
direzione obbligatoria
sinistra/destra



F.H. 260080 D ■
F.R. 260080 D
preavviso di direzione
obbligatoria a destra



F.H. 260080 E ■
F.R. 260080 E
preavviso di direzione
obbligatoria a sinistra



F.R. 260081 A ■
direzioni consentite
destra e sinistra



F.R. 260081 B ■
direzioni consentite
diritto e destra



F.R. 260081 C ■
direzioni consentite
diritto e sinistra



F.H. 260082 A ■
F.R. 260082 A
passaggio obbligatorio a sinistra



F.H. 260082 B ■
F.R. 260082 B
passaggio obbligatorio a destra



F.R. 260083 ■
passaggi consentiti



F.R. 260084 ■
rotatoria



F.R. 260085xx
limite minimo di velocità
(xx=km/h)



F.R. 260086xx
fine del limite minimo di velocità
(xx=km/h)



F.R. 260087
catene per la neve obbligatorie



F.R. 260088
percorso pedonale



F.R. 260089
fine percorso pedonale



F.R. 260090
pista ciclabile



F.R. 260091
fine pista ciclabile



F.R. 260092 A
pista ciclabile contigua
al marciapiede



F.R. 260092 B
percorso pedonale e ciclabile



F.R. 260093 A
fine pista ciclabile
contigua al marciapiede



F.R. 260093 B
fine percorso pedonale
e ciclabile



F.R. 260094
percorso riservato ai quadrupedi
da soma o da sella



F.R. 260095
fine percorso riservato
ai quadrupedi da soma
o da sella

■ Segnale consigliato con pellicola rifrangente CE (classe R2).

SEGNALI CON CERTIFICATO CE DI CONFORMITÀ N° 0474-CPD-0730 RINA SERVICE SECONDO LA NORMA EN12899-1 RISPONDENTI AL CPR305/2011

Croci di S. Andrea

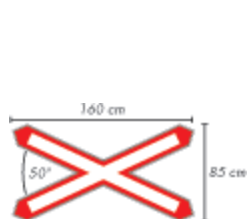

FAR 501010 A *
croce di S. Andrea

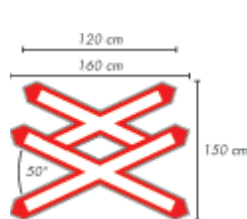

FAR 502010 B *
doppia croce di S. Andrea

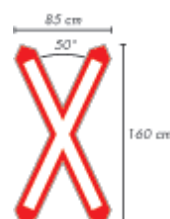

FAR 501010 C *
croce di S. Andrea verticale

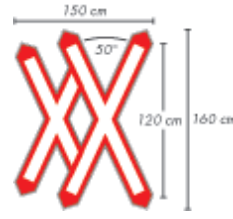

FAR 502010 D *
doppia croce di S. Andrea
verticale

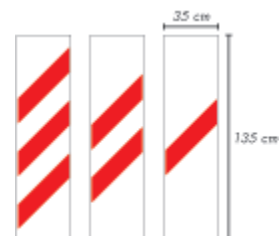

FAR 503011 A B C
serie di 3 pannelli distanziometrici

* Fornibile solo in alluminio



DIMENSIONI DEI TRIANGOLI (cm)



CODICE	FORMATO	A	C	E	R
...16...	Piccolo	60	1	5,5	3
...19...	Normale 90	1,5	8	4,5	
...193...	Grande	120	1,8	12	6

DIMENSIONI DELL'OTTAGONO (cm)



CODICE	FORMATO	A	B	C	D
...460037	Piccolo	60	20	2	50
...490037	Normale	90	30	3	75
FAH493037	Grande	120	40	4	100

MATERIALI

CODICE	DESCRIZIONE DEI MATERIALI
FLR.....	Lamiera sciolata, pellicola rifrangente CE (classe RA1)
FLH.....	Lamiera sciolata, pellicola rifrangente CE (classe R2)
FAR.....	Alluminio sciolato, pellicola rifrangente CE (classe RA1)
FAH.....	Alluminio sciolato, pellicola rifrangente CE (classe R2)

! SEGNALI DISPONIBILI IN LAMIERA SCATOLATA O IN ALLUMINIO SCATOLATO NEL FORMATO E CON PELLICOLA RIFRANGENTE DEL TIPO INDIVIDUABILE DAL CODICE INDICATO SOTTO OGNI SINGOLO ARTICOLO. ALTRI FORMATI O DIVERSE FINITURA RIFRANGENTE FORNIBILI A RICHIESTA.



F.H 490 037 *
fermarsi e dare precedenza



F.R 190 001
strada deformata



F.R 190 002
dosso



F.R 190 003
cunetta



F.R 190 004
curva a destra



F.R 190 005
curva a sinistra



F.R 190 006
doppia curva la prima a destra



F.R 190 007
doppia curva la prima a sinistra



F.R 190 008
passaggio a livello con barriere



F.R 190 009
passaggio a livello senza barriere



F.R 190 012
attraversamento tramviario



F.R 190 013
attraversamento pedonale



F.R 190 014
attraversamento ciclabile



F.R 191 015
discesa pericolosa...



F.R 191 016
salita ripida...



F.R 190 017
strettoia simmetrica



F.R 190 018
strettoia asimmetrica a sinistra



F.R 190 019
strettoia asimmetrica a destra



F.R 190 020
ponte mobile



F.R 190 021
banchina cedevole



F.R 190 022
strada sdrucciolevole



F.R 190 023
bambini



F.R 190 024
animali domestici vaganti



F.R 190 025
animali selvatici vaganti



F.R 190 026
doppio senso di circolazione



F.R 190 027
circolazione rolatoria



F.R 190 028
sbocco su molo o su argine



F.R 190 029
materiale instabile su strada



F.R 190 030 A
caduta massi



F.R 190 030 B
caduta massi



F.R 190 031 A
semaforo con lanterne verticali



F.R 190 031 B
semaforo con lanterne orizzontali



F.R 190 032
aeromobili



F.R 190 033
forte vento laterale



F.R 190 034
pericolo di incendio



F.R 190 035
altri pericoli (da utilizzare sempre con pannello integrativo)



F.H 190 036 *
dare precedenza



F.H 190 040 *
intersezione con precedenza a destra



F.R 190 043 A
intersezione con diritto di precedenza



F.R 190 043 B
intersezione a "T" con diritto di precedenza



F.R 190 043 C
intersezione a "T" con diritto di precedenza



F.R 190 043 D
confluenza a destra



F.R 190 043 E
confluenza a sinistra

* Segnale obbligatorio con pellicola rifrangente **CE** (classe R2).



Pannelli integrativi ai segnali triangolari

DIMENSIONI DEI PANNELLI INTEGRATIVI (cm)



CODICE	FORMATO	A	D	B	C	R
...911...	Piccolo	53	18	0,2	0,6	2
...912...	Normale	80	27	0,4	0,8	3
...913...	Grande	105	35	0,5	1	4
...914...	Normale	80	80	0,4	0,8	3

MATERIALI

CODICE	DESCRIZIONE MATERIALE
FLR...	Lamiera scotolata, pellicola rifrangente CE (classe RA1)
FLH...	Lamiera scotolata, pellicola rifrangente CE (classe R2)
FAR...	Alluminio scotolato, pellicola rifrangente CE (classe RA1)
FAH..	Alluminio scotolato, pellicola rifrangente CE (classe R2)

COME COMPORRE IL CODICE



ELEVATA RESISTENZA E DURATA DEI MATERIALI.

* Segnali realizzabili anche in versione FCR...

 FCR 912 pannello neutro	 F.R 912160 * ...distanza	 F.R 912171 ...estesa
 F.R 912172 attraversamento di binari	 F.R 912174 sgomberareve in azione	 F.R 912175 strada sdrucciolevole per pioggia
 F.R 912176 strada sdrucciolevole per ghiaccio	 F.R 912177 zona soggetta ad allagamento	 F.R 912178 * mezzi di lavoro in azione
 F.R 912180 *	 F.R 912183	 F.R 912184
 F.R 912185 *	 F.R 912189 *	 F.R 912191 *
 F.R 912193	 F.R 912194 *	 F.R 912195
 F.R 912196 *	 F.R 914063 coda	 F.R 914064 autocarri in rallentamento
 F.R 912197		

Pannelli integrativi ai segnali circolari

DIMENSIONI PANNELLI INTEGRATIVI (cm)

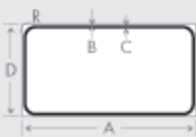

CODICE	FORMATO	A	D	B	C	R
921...	Piccolo	33	17	0,3	0,6	2
922...	Normale	50	25	0,4	0,8	3
923...	Grande	75	33	0,5	1	4

 FCR 922 neutro	 F.R 922001 pulizia stradale	 F.R 922002 * rimozione coatta	 F.R 922003 validità
 F.R 922004 validità	 F.R 922005 eccezione	 F.R 922006 limitazione	 F.R 922007 validità giorni lavorativi
 F.R 922008 validità giorni festivi	 F.R 922009 escluso mezzi autorizzati	 F.R 922010 escluso carico e scarico	 F.R 922011 * ambo i lati

* Segnali realizzabili anche in versione FCR...

DIMENSIONI INIZIO-CONTINUA (cm)

CODICE	FORMATO	A	D	B	C	R
901... ■	Piccolo	25	10	0,2	0,4	2
902...	Normale	35	15	0,3	0,6	3

■ Fornito completo di collarino per applicazione a palo Ø 48.

 F.R 902101 * inizio	 F.R 902102 * continua	 F.R 902103 * fine
 F.R 902111 * inizio	 F.R 902112 * continua	
 F.R 902113 * fine		



DIMENSIONI DEI QUADRATI (cm)



CODICE	FORMATO	FORMA	A	B	C	D	Q	R
...641...	Piccolo	Quadrato	40	0,3	0,6	-	-	2,5
...660...	Normale	Quadrato-rombo	60	0,5	1	-	40	3,5
...661...	Normale	Quadrato	60	0,5	1	-	-	3,5
...691...	Grande	Quadrato	90	0,8	1,5	-	-	5,5
...740...	Ridotto	Rettangolo	40	60	0,8	0,4	-	3
...760...	Piccolo	Rettangolo	60	90	1,2	0,6	-	4,5
...762...	Piccolo	Rettangolo	90	60	1,2	0,6	-	4,5
...790...	Normale	Rettangolo	90	135	1,6	0,8	-	7

! TUTTI I SEGNALI SONO DISPONIBILI IN LAMIERA O ALLUMINIO SCATOLATO NEL FORMATO E CON PELLICOLA RIFRANGENTE DEL TIPO INDIVIDUABILE DAL CODICE INDICATO SOTTO OGNI SINGOLO ARTICOLO. ALTRI FORMATI O DIVERSA FINITURA RIFRANGENTE SONO FORNIBILI A RICHIESTA.

MATERIALI

CODICE	DESCRIZIONE DEI MATERIALI
FLR...	Lamiera scatolata, pellicola rifrangente CE (classe RA1)
FLH...	Lamiera scatolata, pellicola rifrangente CE (classe R2)
FAR...	Alluminio scatolato, pellicola rifrangente CE (classe RA1)
FAH...	Alluminio scatolato, pellicola rifrangente CE (classe R2)

COME COMPORRE IL CODICE

FLH 661 045

Materiale Dimensioni Figura Codice della strada

LA REGISTRAZIONE È EFFETTUATA DA POLIZIA MUNICIPALE PER FINI DI ATTIVITÀ ISTITUZIONALI. ART. 13 CODICE IN MATERIA DI PROTEZIONE DEI DATI PERSONALI (D. LGS. N. 196/2003).



F.R. 641508
area videosorvegliata



F. 641518
area videosorveglianza



F.R. 661045
diritto di precedenza nei sensi unici alternati



F.R. 661076
parcheggio



F.R. 661302
ospedale



F.R. 661303
attraversamento pedonale



F.R. 661304
scuola



F.R. 661305
SOS



F.R. 661306
sottopassaggio pedonale



F.R. 661307
sovrappassaggio pedonale



F.R. 661308
fine strada inclinata pedonale



F.R. 661309
strada senza uscita



F.R. 661310
preavviso di strada senza uscita



F.R. 661311
preavviso di strada senza uscita



F.R. 661312xx
velocità consigliata (xx=km/h)



F.R. 661313xx
fine velocità consigliata (xx=km/h)



F.R. 661314
strada riservata ai veicoli a motore



F.R. 661315
fine strada riservata ai veicoli a motore



F.R. 661318
zona residenziale



F.R. 661319
fine zona residenziale



F.R. 661320
area pedonale urbana



F.R. 661321
fine area pedonale urbana



F.R. 661322
zona traffico limitato



F.R. 661323
fine zona traffico limitato



F.R. 661324
attraversamento ciclabile



F.R. 691341
variazione corsie disponibili



F.R. 691342
variazione corsie disponibili



F.R. 661349
senso unico frontale



F.R. 660044
diritto di precedenza



F.R. 660042
fine del diritto di precedenza



F.R. 760428



F.R. 760429



F.R. 760434



F.R. 760436



F.R. 760480



F.R. 760481



F.R. 760482



F.R. 760490 *

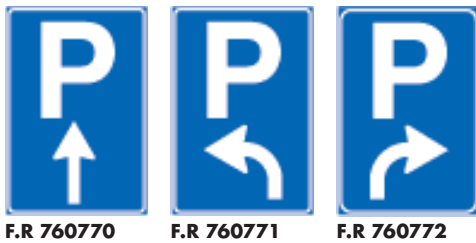

F.R 760770 F.R 760771 F.R 760772

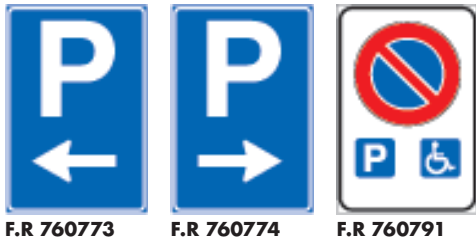

F.R 760773 F.R 760774 F.R 760791



F.R 760792 F.R 760793 F.R 760794



F.R 762378 F.R 762380

* Precisare la direzione della freccia:
D = destra L = sinistra A = avanti

Segnali di indicazione

DIMENSIONI (cm)

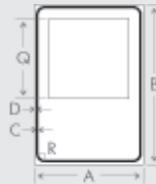

CODICE	FORMATO	A	B	Q	D	C	R
...741...	Piccolo	40	60	30	0,4	0,8	3
...761...	Normale	60	90	45	0,5	1,2	4,5

ELEVATA RESISTENZA E DURATA DEI MATERIALI.

* Precisare direzione della freccia: **D** destra **L** sinistra **A** avanti.



F.R 761277 * pronto soccorso F.R 761278 * stazione F.R 761279 * polizia F.R 761280 * carabinieri F.R 761281 * informazioni



F.R 761282 * ospedale F.R 761284 * polizia municipale F.R 761354 assistenza meccanica F.R 761356 rifornimento F.R 761358 fermata autobus



F.R 761359 fermata tram F.R 761360 informazioni F.R 761365 motel/albergo FLR 761366 bar F.R 761367 ristorante

Segnaletica per agriturismi

DIMENSIONI (cm)

CODICE	MATERIALE	FORMATO
5701Z	Alluminio	60 x 90
FLR5701Z	Lamiera sciolata (cl. RA1)	60 x 90
R5701Z	Alluminio (classe RA1)	60 x 90
FLR7001	Lamiera sciolata (cl. RA1)	125 x 25



5701 Z

NORMATIVA

L'azienda agrituristica deve utilizzare targhe segnaletiche e tabelle identificative riportanti il marchio regionale agrituristico così come previsto dalla d.g.r. n. 69319 del 12 giugno 1995.



FLR7001

Simboli per segnaletica di indicazione e direzione

In pellicola rifrangente **CE** (classe RA1) autoadesiva, dimensioni: 180 x 180 mm. Minimo ordinabile 5 pezzi/multipli.



SR100 SR101 SR103 SR104 SR105 SR106 SR108 SR109 SR110
SR111 SR112 SR113 SR114 SR116 SR120 SR124 SR130 SR131
SR136 SR137 SR138 SR161 SR163 SR168 SR169 SR170 SR171
SR172 SR173 SR174 SR175 SR176 SR180 SR182 SR184 SR186
SR187 SR191 SR192 SR203 SR210 SR215 SR216 SR219



Segnali di direzione

Tutte le tabelle sono munite di 4 attacchi saldati sul retro a croce, che permettono il fissaggio a uno o a due pali (collari esclusi).

DIMENSIONI

CODICE	DIMENSIONI
6	100 x 20 cm
7	125 x 25 cm

DIREZIONE

CODICE	DIREZIONE
A	Avanti
D	Destra
L	Sinistra

MATERIALI

CODICE	DESCRIZIONE DEI MATERIALI
FLR....	Lamiera scatolata, pellicola rifrangente CE (classe RA1)
FLH....	Lamiera scatolata, pellicola rifrangente CE (classe R2)
FAR....	Alluminio scatolato, pellicola rifrangente CE (classe RA1)
FAH....	Alluminio scatolato, pellicola rifrangente CE (classe R2)

COLORI *

CODICE	0	4	5	6	8
FONDO	Bianco	Nero	Marrone	Verde	Blu
SCRITTE	Nero	Giallo	Bianco	Bianco	Bianco

* La rifrangenza è ottenuta: nel colore 0 solo il fondo rifrangente; nel colore 4 solo con scritte rifrangenti; nei colori 5 - 6 - 8 con fondo e scritte rifrangenti.

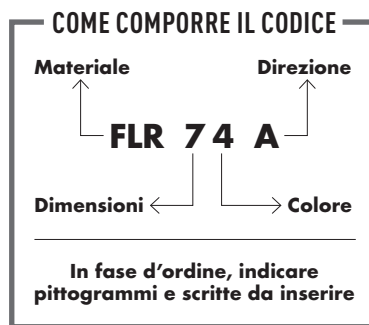

! LE TABELLE POSSONO ESSERE PERSONALIZZATE PER QUANTITÀ INFERIORE A 10 PEZZI (VEDI PAGINA 20).

SEGNALI TURISTICI, DI TERRITORIO E DI DIREZIONE ALBERGHIERA

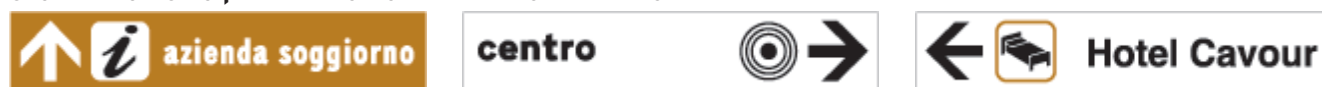

SEGNALI DI AVVIO ALLA ZONA INDUSTRIALE E DI DIREZIONE PER LE INDUSTRIE

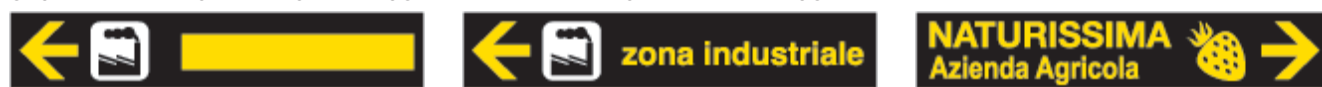

SEGNALI DI DIREZIONE URBANA



Segnali di direzione extraurbano

DIMENSIONI E COLORE

CODICE	DIMENSIONI	COLORE FONDO
...530	130 x 30 cm	Bianco
...535	130 x 30 cm	Marrone
...536	130 x 30 cm	Verde
...538	130 x 30 cm	Blu
...540	150 x 40 cm	Bianco
...545	150 x 40 cm	Marrone
...546	150 x 40 cm	Verde
...548	150 x 40 cm	Blu

MATERIALI

CODICE	DESCRIZIONE DEI MATERIALI
FLR.....	Lamiera scatolata, pellicola rifrangente CE (classe RA1)
FAR.....	Alluminio scatolato, pellicola rifrangente CE (classe RA1)

COME COMPORRE IL CODICE



Segnale senso unico parallelo



FLR 807348 - segnale senso unico parallelo in lamiera scatolata, pellicola rifrangente CE (classe RA1). Dimensioni: cm 100 x 25

FAR 807348 - segnale senso unico parallelo in alluminio scatolato, pellicola rifrangente CE (classe RA1). Dimensioni: cm 100 x 25

FAR 808348 - segnale senso unico parallelo in alluminio scatolato, pellicola rifrangente CE (classe RA1). Dimensioni: cm 80 x 25

Targhe viarie



FAR 080025 - targa viaria in alluminio scatolato, pellicola rifrangente CE (classe RA1). Dimensioni: cm 80 x 25

FAR 100025 - targa viaria in alluminio scatolato, pellicola rifrangente CE (classe RA1). Dimensioni: cm 100 x 25

i A RICHIESTA FORNIBILI COMPLETE DI NOME STRADA A LETTERE APPLICATE AUTOADESIVE.



Segnali di inizio e fine località

MARCATURA CE

CORREDATI DI FISSAGGI E DOP

DIMENSIONI	
CODICE	DIMENSIONI
816.	160 x 70 cm
818.	180 x 70 cm
820.	200 x 70 cm

MATERIALI	
CODICE	MATERIALI
FLR....	Lamiera sciolata, pellicola rifrangente CE (classe RA1)
FAR....	Alluminio sciolato, pellicola rifrangente CE (cl. RA1)

COME COMPORRE IL CODICE

FAR 8180
↓ Materiale Dimensioni ↓

In fase d'ordine, indicare il nome della località

INIZIO CENTRO ABITATO



F.R 8160 F.R 8180 F.R 8200

FINE CENTRO ABITATO



F.R 8161 F.R 8181 F.R 8201

INIZIO PROVINCIA



F.R 8168 F.R 8188 F.R 8208

FINE PROVINCIA



F.R 8169 F.R 8189 F.R 8209

INIZIO REGIONE



F.R 8168 F.R 8188 F.R 8208

FINE REGIONE



F.R 8169 F.R 8189 F.R 8209

Delineatori di curva

MATERIALI

CODICE	MATERIALI
FLR....	Lamiera sciolata, pellicola rifrangente CE (classe RA1)
FAR....	Alluminio sciolato, pellicola rifrangente CE (cl. RA1)

DELINEATORE DI CURVA STRETTA O DI TORNANTE (Fig. 466 del C.d.S.)



F.R 8244 - cm 240 x 60 F.R 8364 - cm 360 x 90

DELINEATORE PER INTERSEZIONE A "T" (Fig. 467 del C.d.S.)



F.R 8245 - cm 240 x 60 F.R 8365 - cm 360 x 90

DELINEATORE MODULARE DI CURVA (Fig. 468 del C.d.S.)



F.R 8064
cm 60 x 60
F.R 8094
cm 90 x 90

i SEGNALI CON CERTIFICATO CE DI CONFORMITÀ N° 0474-CPD-0730 RINA SERVICE SECONDO LA NORMA EN12899-1 RISPONDENTI AL CPR305/2011.

MARCATURA CE

CORREDATI DI FISSAGGI E DOP

DELINEATORE PER DEVIAZIONI PROVVISORIE (Figura 393 del C.d.S.)



FCR 8247 - dimensioni: cm 240 x 60

FCR 8367 - dimensioni: cm 360 x 90

DELINEATORE DI CURVA PROVVISORIA (Figura 395 del C.d.S.)



FCR 8067 - dimensioni: cm 60 x 60

FCR 8097 - dimensioni: cm 90 x 90

A RICHIESTA, FORNIBILE SEGNALE ALLERTA METEO CON SEMAFORO. RICHIEDI UN PREVENTIVO!



Targhe viarie e numeri civici

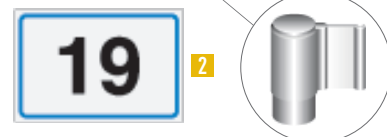

1 TARGHE VIARIE

In alluminio estruso 16 mm, pellicola rifrangente CE (classe RA1) bifacciali con bordino e staffa per palo Ø 60 mm. A richiesta fornibili con nome strada a lettere applicate autoadesive.

FAB 06020R - targa viaria cm 60 x 20

FAB 08020R - targa viaria cm 80 x 20

FAB 08025R - targa viaria cm 80 x 25

FAB 10025R - targa viaria cm 100 x 25

FAB 10030R - targa viaria cm 100 x 30

2 NUMERI CIVICI

In alluminio piano 20 mm, pellicola rifrangente CE (classe RA1) con bordino. A richiesta fornibili con numero civico in cifre applicate autoadesive.

R1510 - numero civico, mm 150 x 100

R1612 - numero civico, mm 160 x 120

R1812 - numero civico, mm 180 x 120

Segnale normalizzato ENEL



3 TRIANGOLO PERICOLO ONDE DI PIENA IMPROVVISE

FLR 162500 - triangolo pericolo onde di piena cm 60, in lamiera sciolata

FAR 162500 - triangolo pericolo onde di piena cm 60, in alluminio sciolato



4 PANNELLO INTEGRATIVO IN 4 LINGUE

FLR 662500 - pannello integrativo cm 60 x 60 in lamiera sciolata

FAR 662500 - pannello integrativo cm 60 x 60 in alluminio sciolato



SEGNALI PER CANTIERI TEMPORANEI

I segnali FCR... sono utilizzabili solo nei cantieri temporanei (non come segnali stradali verticali permanenti costruiti secondo la norma EN 12899-1:2007).

Segnali FCR in lamiera scotolata con pellicola rifrangente CE (classe RA1).

DIMENSIONI

CODICE DIMENSIONI

160...	Triangolo lato 60 cm
190...	Triangolo lato 90 cm
56... J	Tabella 60 x 40 cm
56... Y	Tabella 40 x 60 cm
56... Z	Tabella 60 x 90 cm
56... Q	Tabella 90 x 60 cm
661...	Quadrato lato 60 cm
790...	Tabella 90 x 135 cm
914...	Tabella 80 x 80 cm

COME COMPORRE IL CODICE

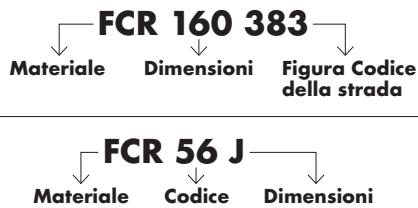

FCR 532722

Dimensioni: cm 130 x 30
(precisare direzione della freccia: **D** = destra **L** = sinistra)



FCR 807710

Dimensioni: cm 100 x 25



FCR 160383
FCR 190383 ■
lavori



FCR 160384
FCR 190384
stretta simmetrica



FCR 160385
FCR 190385
stretta asimmetrica a sinistra



FCR 160386
FCR 190386
stretta asimmetrica a destra



FCR 160387
FCR 190387
doppio senso di circolazione



FCR 160388
FCR 190388
altri pericoli



FCR 160389
FCR 190389
strada deformata



FCR 160390
FCR 190390
materiale instabile sulla strada



FCR 160404
FCR 190404
semaforo



FCR 914061
segni orizzontali
in riforcamento



FCR 661045
diritto di precedenza
nei sensi unici alternati



FCR 914062
incidente



FCR 5648 Y Z
direzione pedoni
obbligatoria a destra



FCR 5649 Y Z
direzione pedoni
obbligatoria a sinistra



FCR 790409 ● A
preavviso di direzione
autocarri obbligatoria



FCR 790409 ● B
direzione autocarri
obbligatoria



FCR 790410 ● A
preavviso di direzione
autocarri consigliata



FCR 790410 ● B
direzione autocarri
consigliata



FCR 790411 A D
segnalazione
corsia chiusa (destra)



FCR 790411 A L
segnalazione
corsia chiusa (sinistra)



FCR 790411 B D
segnalazione
corsia chiusa (destra)



FCR 790411 B L
segnalazione
corsia chiusa (sinistra)



FCR 790411 C
segnalazione
corsie chiuse



FCR 790412 A
segnalazione
carreggiata chiusa



FCR 790412 B
segnalazione
rientro carreggiata



FCR 790414
segnalazione uso corsie
disponibili



FCR 5665



FCR 5666



FCR 56100



FCR 56101

■ Segnale in lamiera scotolata, pellicola rifrangente CE (classe RA2/RZ)

● Precisare direzione della freccia: **D** = destra **L** = sinistra **A** = avanti



SEGNALE PASSAGGIO OBBLIGATORIO PER VEICOLI OPERATIVI (Figura 398 art. 38 del C.d.S.)



PNH160 - in alluminio piano 15/10, pellicola rifrangente €€ classe RA2/R2. Lato pannello cm 90, disco con freccia fissa Ø cm 60, direzione destra

PNH161 - come sopra, direzione sinistra

FAH 693398 - in alluminio sciolto 2,5 mm, pellicola rifrangente €€ classe RA2/R2, lato cm 90. Disco Ø cm 60, con freccia in alluminio piano girevole di 90° (destra o sinistra)

TABELLA LAVORI (Figura 382 del C.d.S.)

Lavori di	
Ordinanza	
Impresa	
Inizio	Fine
Recapito	
Tel.	

OBBLIGATORIO PER CANTIERI DI DURATA SUPERIORE AI 7 GIORNI.

FCR 820382
Dimensioni cm 200 x 150



1

SIMBOLO

TESTO

A RICHIESTA, REALIZZIAMO PANNELLI CON QUALSIASI PITTOGRAMMA E/O SCRITTA. RICHIEDI UN PREVENTIVO!



1 SEGNALE DI PREAVVISO TEMPORANEO A CAVALLETTO

Segnale di preavviso temporaneo a cavalletto. Principale utilizzo: segnalare postazioni di rilevazione elettronica della velocità. Richiudibile, ingombro ridotto, può essere alloggiato nel vano bagagli dell'autovettura. I pannelli sono intercambiabili in funzione sia dell'ente sia del messaggio che si vuol trasmettere.

CNS8089 - cavalletto senza segnale in PVC, dimensioni mm 390 x 80 x 955 h, peso kg 6

CNS91.. - solo pannello in PVC 1 spessore mm classe 1, dimensioni mm 325 x 650

CNS92.. - solo pannello in PVC spessore 1 mm classe 2, dimensioni mm 325 x 650



2

ALTRI KIT SEGNALETICI PER PRONTO INTERVENTO A PAGINA 290.

4

ALTRI SIMBOLI E/O SCRITTE FORNIBILI A RICHIESTA. RICHIEDI UN PREVENTIVO!

TENDALINI SEGNALETICI

Formati da un telo a tre facce triangolari in tessuto rifrangente di classe 1 a garanzia del 100% di rifrangenza notturna. Il telo rifrangente può essere stampato con figure e tabelle conformi al Codice della Strada oppure con simbologie e scritte personalizzate.

2 TS802 - tendalino lato cm 80, ingombro aperto cm 100 x 100 x 82 h, ingombro chiuso cm 8 x 10 x 97 h. Peso kg 3,4. Con simbolo "altri pericoli (cm 60)" su 1 lato, "passaggio obbligatorio a sinistra" su 1 lato, "passaggio obbligatorio a destra" su 1 lato

3 TS803 - tendalino lato cm 80, ingombro aperto cm 100 x 100 x 82 h, ingombro chiuso cm 8 x 10 x 97 h. Peso kg 3,4. Con simbolo "figura incidente" + scritta "Polizia Municipale" su 1 lato, "passaggio obbligatorio a sinistra" su 1 lato, "passaggio obbligatorio a destra" su 1 lato (fornibile su specifica richiesta dell'Ente)

4 TS801 - tendalino lato cm 80, ingombro aperto cm 100 x 100 x 82 h, ingombro chiuso cm 8 x 10 x 97 h, peso kg 3,4. Simbolo "altri pericoli (cm 60)" su 3 lati
TS901 - tendalino lato cm 90, ingombro aperto cm 110 x 110 x 96 h, ingombro chiuso cm 8 x 10 x 112 h, peso kg 3,9. Simbolo "altri pericoli (cm 90)" su 3 lati



Cartelli per cantieri in polionda "Polistrong" 500 x 670 mm

Il propilene alveolare è un pannello rigido insensibile agli agenti atmosferici e chimici, durevole, igienico, idrorepellente; può essere facilmente fissato con chiodi, viti e graffette. Non è pericoloso né per l'ambiente né per la salute. Leggero, maneggevole e a costi contenuti è l'ideale per l'utilizzo in cantiere.

A RICHIESTA FORNIBILI ANCHE CARTELLI DELLA LINEA VITA.



PO5001



PO5002



PO5003



PO5004



PO5005



PO5006



PO5033



PO5007



PO5008



PO5009



PO5010



PO5011



PO5012



PO5013



PO5014



PO5015



PO5016



PO5017



PO5018



PO5019



PO5020



PO5021



PO5022



PO5023



PO5024



KIT CAVALLETTI



KIT CAVALLETTO PRONTO INTERVENTO

Kit segnaletica di pronto intervento composto da cavalletto richiudibile in ferro zincato Ø 14 mm e segnale con pellicola rifrangente di classe 1 o classe 2 prismatica posato su supporto in materiale plastico. Pratico, leggero, maneggevole, estremamente utile nelle situazioni di emergenza, **ideali per furgoni attrezzati**. Fornibili con le figure del Codice della Strada. Misura esterna 68 x 68 cm, peso 3 kg circa. Disponibile con:

- disco Ø 60 cm
- triangolo lato 60 cm
- quadrato 60 x 60 cm

1 CVGLR6... - kit cavalletto più disco Ø 60 rifrangente classe 1 (aggiungere la figura del C.d.S.)

CVGLH6... - kit cavalletto più disco Ø 60 rifrangente classe 2 PR. (aggiungere la figura del C.d.S.)

CVGLR7... - kit cavalletto più disco girevole Ø 60 rifrangente classe 1 (aggiungere la figura del C.d.S.)

CVGLH7... - kit cavalletto più disco girevole Ø 60 rifrangente classe 2 (aggiungere la figura del C.d.S.)

2 CVGLR8... - kit cavalletto + triangolo da 60 rifrangente classe 1 (aggiungere la figura del C.d.S.)

CVGLH8... - kit cavalletto + triangolo da 60 rifrangente classe 2 (aggiungere la figura del C.d.S.)

CVGLR9... - kit cavalletto + targa da 60 x 60 rifrangente classe 1 (aggiungere la figura del C.d.S.)

CVGLH9... - kit cavalletto più targa da 60 x 60 rifrangente classe 2 (aggiungere la figura del C.d.S.)

KIT CAVALLETTO CONFORME AL C.d.S.

Kit segnaletica di pronto intervento composto da cavalletto richiudibile in ferro zincato Ø 14 mm e segnale con pellicola rifrangente di classe 1 o classe 2 prismatica posato su supporto in materiale composito. Pratico, leggero, maneggevole, estremamente utile nelle situazioni di emergenza, **ideali per furgoni attrezzati**. Misura esterna 68 x 68 cm, peso 3,5 kg circa. **Conforme al C.d.S.: segnale ad un'altezza di 60 cm dal suolo.**

Disponibile con:

- disco Ø 60 cm
- triangolo lato 60 cm
- quadrato 60 x 60 cm

3 CVGLR6...N - kit cavalletto più disco Ø 60 rifrangente classe 1 (aggiungere la figura del C.d.S.)

CVGLH6...N - kit cavalletto più disco Ø 60 rifrangente classe 2 PR. (aggiungere la figura del C.d.S.)

CVGLR7...N - kit cavalletto più disco girevole Ø 60 rifrangente classe 1 (aggiungere la figura del C.d.S.)

CVGLH7...N - kit cavalletto più disco girevole Ø 60 rifrangente classe 2 (aggiungere la figura del C.d.S.)

4 CVGLR8...N - kit cavalletto + triangolo da 60 rifrangente classe 1 (aggiungere la figura del C.d.S.)

CVGLH8...N - kit cavalletto + triangolo da 60 rifrangente classe 2 (aggiungere la figura del C.d.S.)

CVGLR9...N - kit cavalletto + targa da 60 x 60 rifrangente classe 1 (aggiungere la figura del C.d.S.)

CVGLH9...N - kit cavalletto più targa da 60 x 60 rifrangente classe 2 (aggiungere la figura del C.d.S.)



5 BORSONE

Può contenere fino a 3 kit cavalletto più cartello.

CVGLBV - borsone vuoto in nylon

A RICHIESTA FORNIBILI BORSONI PER PIÙ DI 3 KIT. RICHIEDI UN PREVENTIVO.



A RICHIESTA VERSIONE PERSONALIZZABILE. RICHIEDI UN PREVENTIVO!

CODICE	DESCRIZIONE
CVGLR7080	kit cavalletto + disco girevole Ø 60 cm classe 1 (figura 080 del C.d.S.)
CVGLH7080	kit cavalletto + disco girevole Ø 60 cm classe 2 (figura 080 del C.d.S.)
CVGLR8386	kit cavalletto + triangolo lato 60 cm classe1 (figura 386 del C.d.S.)
CVGLH8386	kit cavalletto + triangolo lato 60 cm classe 2 (figura 386 del C.d.S.)
CVGLR9045	kit cavalletto + quadrato 60 x 60 cm classe1 (figura 045 del C.d.S.)
CVGLH9045	kit cavalletto + quadrato 60 x 60 cm classe 2 (figura 045 del C.d.S.)



CONFORME AL C.d.S. SEGNALE A 60 CM DAL SUOLO.

INGOMBRO MINIMO, LEGGERI E FACILMENTE TRASPORTABILI!

CODICE	DESCRIZIONE
CVGLR7080N	kit cavalletto + disco girevole Ø 60 cm classe 1 (figura 080 del C.d.S.)
CVGLH7080N	kit cavalletto + disco girevole Ø 60 cm classe 2 (figura 080 del C.d.S.)
CVGLR8386N	kit cavalletto + triangolo lato 60 cm classe1 (figura 386 del C.d.S.)
CVGLH8386N	kit cavalletto+ triangolo lato 60 cm classe 2 (figura 386 del C.d.S.)
CVGLR9045N	kit cavalletto + quadrato 60 x 60 cm classe1 (figura 045 del C.d.S.)
CVGLH9045N	kit cavalletto + quadrato 60 x 60 cm classe 2 (figura 045 del C.d.S.)

DIFFERENZE TRA PELLICOLA CLASSE 1 E CLASSE 2

CLASSE 1

- Pellicola a normale risposta luminosa.
- Durata minima 7 anni.
- Uso: cantieristica su strade a bassa viabilità, segnaletica verticale permanente

CLASSE 2

- Pellicola a alta risposta luminosa.
- Durata minima 10 anni.
- Uso: cantieristica strade ad alta viabilità, superstrade ed autostrade, segnaletica verticale dove previsto (sempre per fig. 37 - STOP e fig. 36 - dare precedenza)



Cavalletti portasegnales

Nuovi cavalletti portasegnales a norme ministeriali. Gazzetta Ufficiale n. 226 del 26/09/2002, Ministero delle Infrastrutture e dei Trasporti. Decreto 10/07/2002.

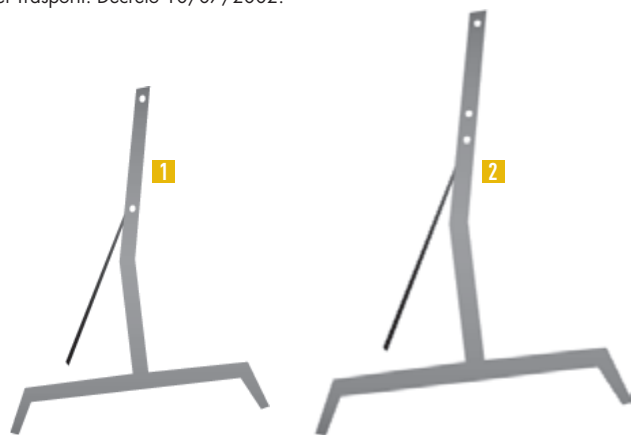

CAVALLETTI IN PROFILO MAGGIORATO

- 1 CVV120** - cavalletto cm 55 x 120 h in ferro verniciato per cartelli: disco Ø 40/60 cm e triangolo lato 60/90 cm (distanza da terra del segnale montato 86/68 cm e 85/68 cm), pannello 60 x 60 cm, triangolo lato 60 cm + pannello 53 x 18 cm. Fissaggio di ogni cartello con n° 2 piastrine CLC125 (non in dotazione). Peso kg 2,95
- 2 CVV150** - cavalletto cm 75 x 150 h in ferro verniciato per cartelli: disco Ø 90 cm, triangolo lato 90 (distanza da terra del segnale montato 98 cm) triangolo lato 120 cm, pannello 60 x 90/90 x 90 cm, triangolo lato 90 cm + pannello 80 x 25 cm. Fissaggio di ogni cartello con n° 2 piastrine CLC125 (non in dotazione). Peso kg 4,3

CAVALLETTI PORTASEGNALI

- 3 CVL115** - portasegnales verticale in scatoles di ferro 15/10 verniciato a polveri montato con accessori e viteria autobloccante zincata. Per triangolo lato 90 cm (distanza da terra del segnale montato 63 cm) disco Ø 60 cm, quadrato lato 60 cm e relative appendici. Forniti completi di piastrine saldate. Bulloni esclusi (CBK825 o CBK25)
- 4 CVL135** - portasegnales verticale per triangolo lato 120 cm (distanza da terra del segnale montato 80 cm) disco Ø 90 cm, quadrato lato 90 cm e relative appendici. Forniti completi di piastrine saldate. Bulloni esclusi (CBK825 o CBK25)

5 PORTASEGNALI A LIBRO (non conforme al D.M. 26-09-2002)

Tubo sezione quadrata mm 15 x 15 spessore 1,5, bande spessore mm 30 x 2. Per disco Ø cm 60, triangolo lato cm 90 (distanza da terra del segnale montato 66 cm). Fissaggio di ogni cartello: 1 piastrina CLC125 + 2 bulloni CBK25 o CBK825 (non in dotazione).

VCP120 - portasegnales in ferro verniciato, dimensioni cm 58 x 120 h, peso kg 3

PORTASEGNALI PER AREE PRIVATE (non conformi al D.M. 26-09-2002)

- 6 CVS069** - portasegnales in tondino di ferro Ø mm 8, dimensioni cm 69 x 50 (h x b), kg 1,8. Idoneo per dischi Ø 40/60 cm, triangoli lato 60/90 cm (distanza da terra del segnale montato 23,5/5 cm e 20/5 cm), tabelle 60 x 60 cm. Ferro piatto mm 25 x 3, ferro piatto mm 15 x 5 (astina). Finitura: verniciatura a polvere
- 7 CV080** - portasegnales verniciato nero, asta h 80 cm, kg 2,3. Per cartelli: disco Ø 40/60 cm (distanza da terra del segnale montato 37/19 cm), triangolo lato 60/90 cm (distanza da terra del segnale montato 34/19 cm), pannello 60 x 60 cm. Fissaggio del cartello con 2 piastrine CLC125 e 4 bulloni CBK25 non in dotazione

8 SOSTEGNO AD ARCO (non conforme al D.M. 26-09-2002)

Per disco Ø 60 cm, con traversi in profilato ad U saldato. **SA06** - sostegno ad arco in tubo verniciato Ø 33 mm

9 STAFFA A MURARE (non conforme al D.M. 26-09-02)

Per applicazione a bandiera di cartelli scatoles: disco Ø 40/60 cm, triangolo lato 60/90 cm. Fissaggio di ogni cartello con 2 piastrine CLC125 (non in dotazione).

MS01 - staffa per cartelli in ferro verniciato

STAFFA TUBOLARE A MURO + KIT DI FISSAGGIO PER SEGNALI STRADALI

Staffa a muro per cartello scatoles + morsetto a T per pali (bulloneria di fissaggio compresa). Palo non incluso (vedi pagina 293).

- 10 CVS049** - staffa a muro + kit per pali Ø 48 mm
- 11 MOT48** - solo morsetto a T per pali Ø 48 mm
- MOT60** - solo morsetto a T per pali Ø 60 mm

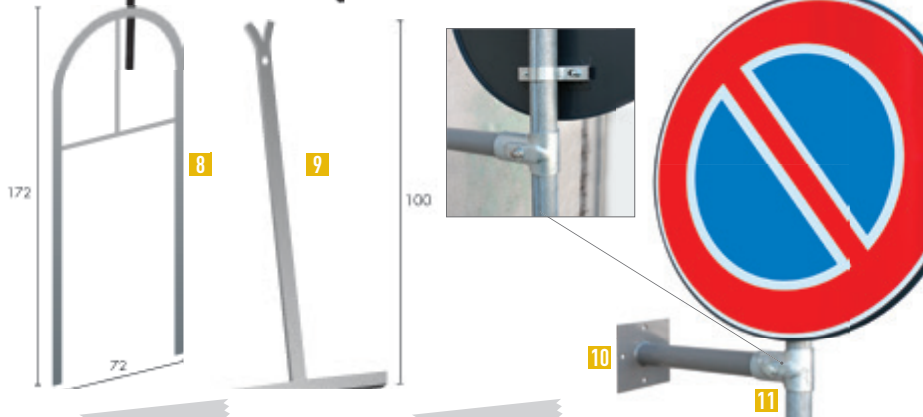

ARTICOLI RINFRESCANTI A PAGINA 395.

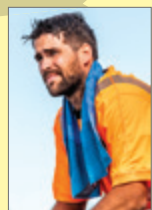

SISTEMI DI ILLUMINAZIONE PER AREE ESTESE A PAGINA 249.





STAFFE, NASTRI, FASCETTE, COLLARI E KIT DI FISSAGGIO



1 STAFFE DI FISSAGGIO

Per ancoraggio su pali di qualsiasi forma e diametro. In acciaio inox AISI 304, installabili mediante sistema di nastri e graffe tipo Band-It, che ne assicura la necessaria tenuta meccanica. Le asole da mm 19,5 permettono di utilizzare un nastro di acciaio tipo Band-It di altezza fino a 19 mm. Necessitano di 2 bulloni tipo CB.25 (non in dotazione).

CLM14219 - staffa di fissaggio, lunghezza 142 mm, larghezza 38 mm

NASTRO DI ACCIAIO INOX, GRAFFE E UTENSILE

Sistema robusto, resistente, di facile e rapido utilizzo per fissare i cartelli su differenti tipi di sostegno (pali di tipo M, pali LS, tralicci). A seconda del formato del cartello, è possibile scegliere l'ideale altezza del nastro e le corrispettive **graffe di serraggio (in confezione da 100 pezzi)**.

CODICE NASTRO	DIMENSIONI NASTRO	CODICE GRAFFE
2 FSN038	h 9 mm x lunghezza 30 m	FSN038G
2 FSN012	h 13 mm x lunghezza 30 m	FSN012G
2 FSN058	h 16 mm x lunghezza 30 m	FSN058G
2 FSN034	h 19 mm x lunghezza 30 m	FSN034G

3 FSNUT - attrezzo manuale per tendere, stringere e tagliare il nastro e serrare la graffa



FASCETTA AUTOBLOCCANTE IN ACCIAIO INOX

Sistema autobloccante con sistema di serraggio irreversibile, estremamente rapido e facile da utilizzare. Il prodotto è caratterizzato da un'innovativa sfera in acciaio inox che permette l'arresto della fascetta vincolandola definitivamente nella posizione finale desiderata. Disponibili in diverse altezze e lunghezze.

4 FSAU... - fascetta autobloccante, specificare dimensioni (vedi tabella)

5 FSAUT - attrezzo manuale per tendere, stringere e tagliare la fascetta

CODICE	LUNGHEZZA	Ø MAX	LARGHEZZA	IMBALLO (minimo ord.)
FSAU201	201 mm	50 mm	4,6 mm	100 pezzi/multipli
FSAU202	259 mm	69 mm	4,6 mm	100 pezzi/multipli
FSAU203	360 mm	102 mm	4,6 mm	100 pezzi/multipli
FSAU204	520 mm	152 mm	4,6 mm	100 pezzi/multipli
FSAU205	679 mm	203 mm	4,6 mm	100 pezzi/multipli
FSAU206	838 mm	254 mm	4,6 mm	100 pezzi/multipli
FSAU207	1067 mm	305 mm	4,6 mm	100 pezzi/multipli
FSAU208	201 mm	50 mm	7,9 mm	50 pezzi/multipli
FSAU209	259 mm	69 mm	7,9 mm	50 pezzi/multipli
FSAU2010	360 mm	102 mm	7,9 mm	50 pezzi/multipli
FSAU2011	520 mm	152 mm	7,9 mm	50 pezzi/multipli
FSAU2012	679 mm	203 mm	7,9 mm	50 pezzi/multipli
FSAU2013	838 mm	254 mm	7,9 mm	50 pezzi/multipli
FSAU2014	1067 mm	305 mm	7,9 mm	50 pezzi/multipli

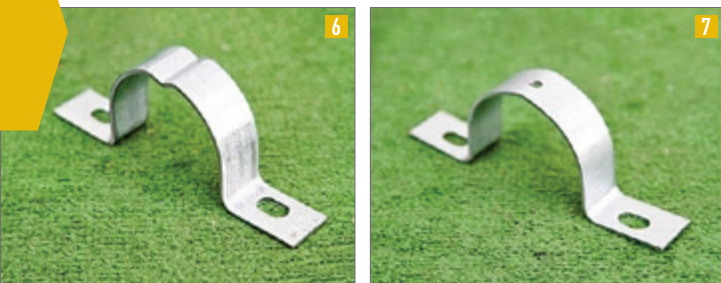

COLLARI ANTIROTAZIONE

Collari semplici antirotazione in ferro zincato. Utilizzando l'attacco a corsoio saldato sul retro degli stessi, permettono l'applicazione a palo dei cartelli scatolati. Minimo ordinabile 10 pezzi/multipli. Necessitano di 2 bulloni tipo CB.25 (non in dotazione).

6 CLS48 - collare in ferro zincato con scanalatura, per pali Ø 48 mm

CLS60 - collare in ferro zincato con scanalatura, per pali Ø 60 mm

CLSX48 - collare in acciaio inox, per pali Ø 48 mm

CLSX60 - collare in acciaio inox, per pali Ø 60 mm

7 CLF48 - collare in ferro zincato con foro per pali Ø 48 mm

CLF60 - collare in ferro zincato con foro per pali Ø 60 mm

CLF90 - collare in ferro zincato senza foro per pali Ø 90 mm



BULLONI ZINCATI

8 CBK25 - confezione da 20 viti M.A. 8 x 25 testa quadra con dado 8 x 6

9 CBK825 - confezione da 100 viti M.A. 8 x 25 testa esagonale con dado 8 x 6

10 PIASTRINA

In ferro zincato per l'applicazione dei cartelli scatolati a cavalletti, staffe a muro, sostegni ad arco. Necessita di 2 bulloni tipo CB.25 (non in dotazione).

CLC125 - mm 127 x 20



11 COLLARI DOPPI

Permettono il montaggio bifacciale di 2 cartelli scatolati. Necessitano di 4 bulloni tipo CB.25 (non in dotazione).

CLP48 - collare per pali in ferro zincato Ø 48 mm

CLP60 - collare per pali in ferro zincato Ø 60 mm



KIT DI FISSAGGIO PER CARTELLI CERTIFICATI

Fissaggi di ricambio per cartelli certificati delle serie FLR, FLH, FAR, FAH (da pagina 278 a 285), unici utilizzabili con i cartelli stradali marcati CE secondo il CPR 305/2011. Ad ogni tipo di fissaggio corrisponde un tipo diverso di giunzione posteriore del pannello.

12 FSA6003 - kit 2 fissaggi Ø 60 mm per attacco stradale **TIPO 3**

13 FSA6004 - kit 2 fissaggi Ø 60 mm per rinforzo **TIPO 4**

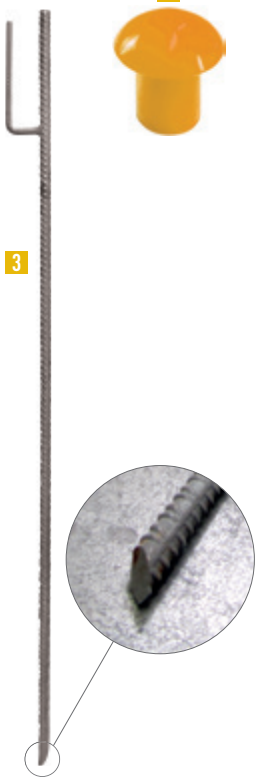

SOSTEGNI MOBILI

In ferro verniciato, con base circolare per pali Ø mm 48.

- 1 **BAC2** - base Ø cm 50 appesantita con cemento, peso kg 19
- 2 **BAC4** - base Ø cm 50, peso kg 3,4

PICCHETTO PER RETE

Picchetto in tondino nervato Ø 16 mm, h cm 120, adatti a supportare reti da cantiere.

- 3 **PAC12** - picchetto con un gancio
- 4 **CML16** - protezione in plastica a fungo per tondo armature, per pali Ø 8-16 mm. Minimo ordinabile 50 pezzi/multipli

5 PALINE GEODETICHE

Paline ottagonali con anima in ferro rivestita in PVC, verniciate a strisce bianco/rosso, puntale in acciaio.

PAG160 - palina geodetica, altezza cm 160

PALI TUBULARI CERTIFICATI PER USO STRADALE

Pali in ferro zincato, spessore mm 2, con tappo in plastica alla sommità (A). Altre lunghezze fornibili a richiesta.



6 CODICI PALI NORMALI	7 CODICI PALI ANTIROTAZIONE	Ø	ALTEZZA
STC412		48 mm	1,20 m
STC415	-	48 mm	1,50 m
STC420	-	48 mm	2,00 m
STC430	-	48 mm	3,00 m
STC433	-	48 mm	3,30 m
STC435	-	48 mm	3,50 m
-	STC6012	60 mm	1,20 m
-	STC6020	60 mm	2,00 m
-	STC6025	60 mm	2,50 m
-	STC6030	60 mm	3,00 m
-	STC6033	60 mm	3,30 m
-	STC6035	60 mm	3,50 m
-	STC6040	60 mm	4,00 m



RETI DA CANTIERE

Reti da cantiere colore arancio, perfetta visibilità, resistenza del colore agli agenti atmosferici ed alla polvere, idonee e riconosciute dal Codice della Strada, alla recinzione dei cantieri edili e stradali.

- 8 **RC180** - rotolo da m 50, altezza m 1,80 (1,6 kN/m) con banda "LAVORI IN CORSO"
- 9 **RC266** - rotolo da m 50, altezza m 1,20 h (3,3 kN/m)



DELIMITATORI, DELINEATORI E SACCHI ZAVORRA

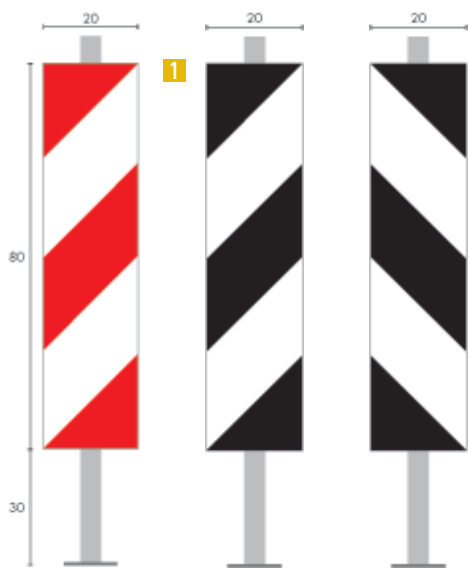

1 PANNELLI DI DELIMITAZIONE

Pannelli in lamiera sciolata e pellicola rifrangente cl. 1. Dimensioni: cm 20 x 80 h. Necessitano di 2 collari CLS48 e 4 bulloni tipo CB.25 per il fissaggio al paletto.

FLR 802 394 - pannello bianco/rosso (Figura 394 del C.d.S.)

FLR 802 471A - pannello bianco/nero, strisce da destra a sinistra (Figura 471 del C.d.S.)

FLR 802 471B - pannello bianco/nero, strisce da sinistra a destra (Figura 471 del C.d.S.)

STC412 - palo in ferro zincato Ø 48 mm, h cm 120 (pagina 293)

BAC4 - base circolare kg 3,4 (pagina 293)



2 DELINEATORE DI ACCESSO (Figura 469 del C.d.S.)

DLA100 - paletto in ferro tubo Ø 60 a fasce bianche e rosse rifrangenti classe 1. Altezza totale cm 120

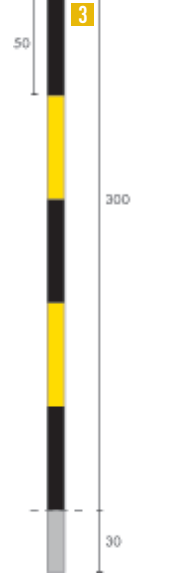

3 DELINEATORE STRADE DI MONTAGNA (Figura 465 del C.d.S.)

DLA300 - paletto in ferro tubo Ø 48 a fasce gialle e nere di cui solo la prima è rifrangente classe 1. Altezza totale cm 330

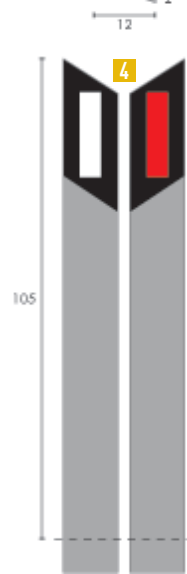

4 DELINEATORI DI MARGINE (Figura 463 del C.d.S.)

DLM102 - segnale in polietilene per strade a doppio senso di circolazione. Bifacciale, con 2 catadiottri rettangolari, rosso lato destro, bianco lato sinistro. Altezza totale cm 135



SISTEMA COMPLETO COMPOSTO DA:

- PANNELLO RETROILLUMINATO A LED 12V Ø 600 MM FIGURA 82/B PER ESTERNO
- DELINEATORE SPECIALE OSTACOLO RETROILLUMINATO A LED 12V CON PELLICOLA RIFRANGENTE CLASSE II
- ALIMENTATORE 230V/12VDC 3,5A CLASSE II CUSTODIA IP56

5 DELINEATORE DI OSTACOLI UNI EN12899

Garantisce una elevata uniformità della retroilluminazione mantenendo consumi ridotti e poca manutenzione. Palo e collari esclusi dalla fornitura.

LAS28660 - kit delineatore di ostacoli UNI EN12899. Fissaggio: guide Omega Standard per collari (esclusi)



SACCHI ZAVORRA IN PVC

Sacchi zavorra ideali per stabilizzare barriere stradali, cavalletti, sostegni ecc. Dimensioni: cm 60 x 40. Capacità: 15/20 lt.

6 SZ25 - sacco riempibile solo con graniglia di pietra

7 SZ24 - sacco riempibile con acqua o sabbia (con tappo ermetico)



SISTEMA COMPLETO COMPOSTO DAI SEGUENTI PEZZI:

- BASE BC248
- CUPOLA CSR50 O CSH50
- PALO STC420 + 2 COLLARI CLS48 + 4 BULLONI TIPO CB.25 (PAG. 292)
- DISCO Ø 60 FIGURA 82 (PAG. 279).

8 DELINEATORE SPECIALE DI OSTACOLO

CSR50 - cupola bombata in alluminio 2,5 mm, dimensioni cm 50 x 44 completa di collari e bulloni con pellicola rifrangente classe 1. Figura 472 del C.d.S.

CSH50 - cupola bombata, come sopra, con pellicola rifrangente, classe 2. Figura 472 del C.d.S.

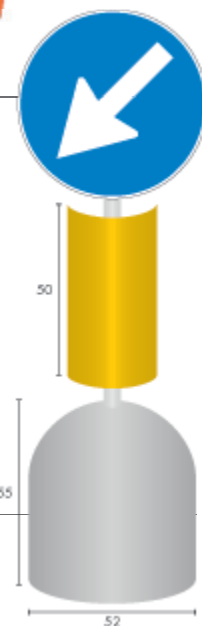



BASI, DISSUASORI DI SOSTA E ARTICOLI PER MOVIERI



BASI IN CEMENTO

Peso 210 kg, Ø 50 cm, altezza cm 50. A richiesta fornibili basi con banda gialla rifrangente.

Basi **con foro per palo**:

- 1 **BC248** - base grigia con foro per palo Ø cm 48
- BC260** - base grigia con foro per palo Ø cm 60
- 2 **BC248Y** - base gialla con foro per palo Ø cm 48
- BC260Y** - base gialla con foro per palo Ø cm 60
- 3 **BC248G** - base grigia con banda gialla e foro per palo Ø cm 48
- BC260G** - base grigia con banda gialla e foro per palo Ø cm 60

Basi **con gancio golfare** per sollevamento:

- 4 **BC200** - base grigia senza foro
- 5 **BC300Y** - base gialla senza foro
- 6 **BC200G** - base grigia con banda gialla, senza foro

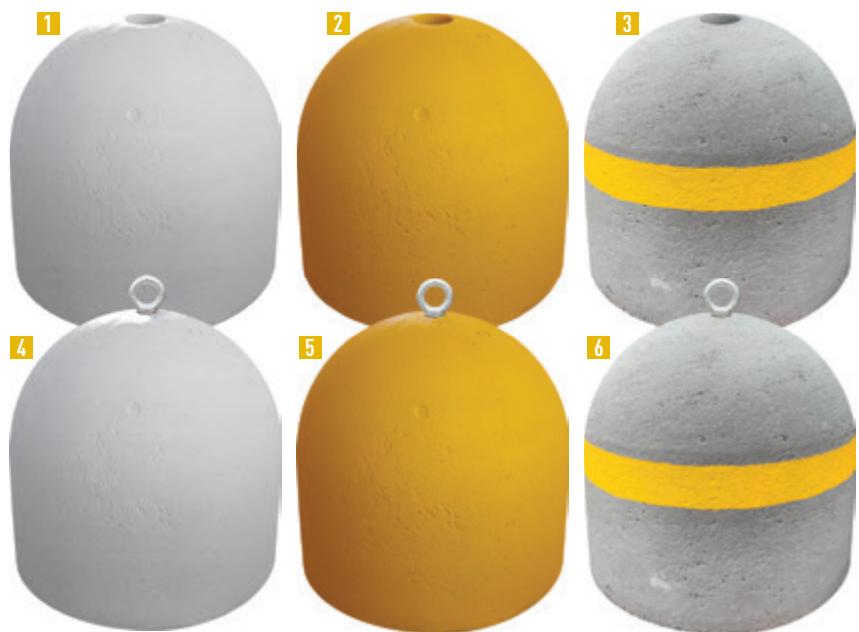

BASI PERSONALIZZATE
FORNIBILI A RICHIESTA.
RICHIEDI UN PREVENTIVO!



DISSUASORE DI SOSTA IN GOMMA RICICLATA

Articolo ecosostenibile, realizzato interamente con gomma riciclata, antitrauma (non danneggia auto o persone in caso di urto). Altezza 530 x Ø 500 mm, peso kg 70, dotato di foro centrale Ø 70 mm. Fornibile nero con banda rifrangente gialla o interamente di colore giallo senza banda rifrangente. A richiesta per quantità può essere realizzato in altri colori, verde o rosso, richiedere offerta.

- 7 **FIS530N** - dissuasore nero con banda rifrangente gialla, foro Ø 68 mm
- 8 **FIS530Y** - come sopra, rivestito con poliuretano elastomero giallo senza banda rifrangente, foro Ø 70 mm
- 9 **FIS531** - kit golfare per dissuasore (per utilizzo dissuasore con catene)



DISSUASORE MOBILE ZAVORRABILE E IMPILABILE

Resistente ai raggi UV, eccellenti doti di resistenza agli urti. Utilizzata per la delimitazione di percorsi, parcheggi temporanei, passaggi di mezzi speciali, aree verdi, aree pedonali, ecc... Predisposta per l'inserimento di pali diametro mm 48 ai quali si può applicare la segnaletica stradale, per supporto alla viabilità. Dotata di 2 tappi filettati 3/4": tappo di carico posto nella parte superiore e tappo di scarico posto in basso.

- 10 **DIST001Y** - dissuasore mobile 100% polietilene atossico colore giallo di alta qualità
- 11 **DIST001YR** - dissuasore mobile 100% polietilene atossico colore giallo con banda rifrangente



12 CORDA SEGNALETICA

Corda fluorescente in polipropilene Ø 10 mm ad alta resistenza, lunghezza rotoli m 200.

- OSC421** - corda colore giallo
- OSC422** - corda colore rosso



13 BANDIERINA SEGNALETICA

Per movieri, in tela nylon spalmata PVC colore arancio fluorescente con asta in legno.

- BSL108** - dimensioni cm 80 x 60 x 108 lunghezza asta



14 PALETTA SEGNALETICA

Per movieri, conforme alla figura 403 del C.d.S. In polietilene alta densità, dischi rifrangenti rosso/verde, leggera e resistente.

- PSS30** - disco Ø 30 cm con manico lunghezza cm 20



CATENE IN PLASTICA, COLONNINE E ACCESSORI



CATENE IN PLASTICA (MOPLEN RO)

Ad iniezione continua senza saldature. Per le loro caratteristiche trovano impiego nella segnaletica stradale e antinfortunistica, nautica, ferrovie, campi sportivi, porti e aeroporti, campeggi, fiere e mostre, delimitazione di zone pericolose, ecc. Resistono alle intemperie, alle temperature -10°C +75°C, alla salsedine e agli agenti chimici. Sono isolanti, leggere, galleggianti, antimagnetiche, inossidabili, inalterabili nel colore (colorazione incorporata). **Bicolore alternato ogni 45 centimetri circa. Per tutti i tipi di catena minimo ordinabile in unico spezzone di 25 metri/multipli.**



DIMENSIONI CATENE IN PLASTICA

CODICE ARTICOLO	DIMENSIONI MAGLIA (mm)	PESO (g x m)	COLORE
1 CP1011	2 x 8 x 14	13	Bianco
CP103	5 x 20 x 30	52	Bianco/rosso
2 CP1032	5 x 20 x 30	52	Giallo/nero
CP1033	5 x 20 x 30	52	Rosso
CP104	6 x 24 x 39	70	Bianco/rosso
3 CP1042	6 x 24 x 39	70	Giallo/nero
CP1046	6 x 24 x 39	70	Verde
CP105	8 x 29 x 49	130	Bianco/rosso
CP1052	8 x 29 x 49	130	Giallo/nero
4 CP1053	8 x 29 x 49	130	Rosso
CP1054	8 x 29 x 49	130	Giallo
CP1055	8 x 29 x 49	130	Nero
CP1056	8 x 29 x 49	130	Verde
CP106	10 x 42 x 74	210	Bianco/rosso
5 CP1063	10 x 42 x 74	210	Rosso
CP1065	10 x 42 x 74	210	Nero

KIT DA 5 METRI:

CP1035 - catena CP103 lunghezza 5 metri + 2 anelli AGK1035

CP1045 - catena CP104 lunghezza 5 metri + 2 anelli AGK1045

CP1055 - catena CP105 lunghezza 5 metri + 2 anelli AGK1055

ANELLI E GANCI

Anelli a spirale e ganci di giunzione per catene in plastica. Permettono di unire più spezzoni di catene tra loro e facilitano l'aggancio delle stesse a colonnine in plastica. In confezione da 25 pezzi.

6 **AGK1025** - anelli a spirale mm 3 x 13 x 21

AGK1035 - anelli a spirale mm 5 x 20 x 30

AGK1045 - anelli a spirale mm 6 x 24 x 39

AGK1055 - anelli a spirale mm 8 x 29 x 49

7 **AGK3035** - ganci ad "S", Ø mm 8

8 TARGHETTA

Con catadiottero incorporato, per applicazione alle maglie delle catene. Dimensioni targhetta: mm 140 x 105. Dimensioni catadiottero: Ø mm 60. Minimo ordinabile 4 pezzi/multipli.

CP3045 - targhetta con catadiottero



9

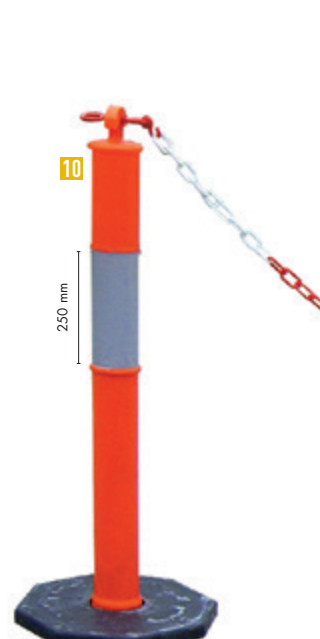

10

250 mm



Ø 100 mm

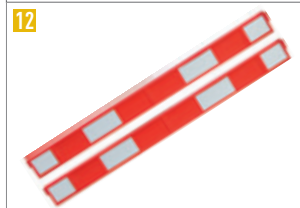

12



9 PALETTI IN PLASTICA

Colore bianco, con puntale.

PAP4060 - Ø mm 40, fuori terra h cm 60 (h totale cm 87)

PAP4100 - Ø mm 40, fuori terra h cm 100 (h totale cm 127)

COLONNINA IN POLIPROPILENE

Delimitano corsie di circolazione o aree. Con base pesante in gomma kg 5 e banda rifrangente di classe 2 ad alta luminosità. Utilizzabile con catene, nastri in polietilene applicando gli anelli opzionali o con kit di barriere rigide in PVC (CNV115).

10 **CNV110** - colonnina in polipropilene Ø cm 10 x h 110. Peso kg 6,80

11 **CNV111** - coppia di anelli per l'utilizzo con catene o nastri in polietilene, Ø mm 30

12 **CNV115** - kit 2 barre in PVC cm 120 x 10 h, colore bianco/rosso per utilizzo con colonnine



1 COLONNINE IN PLASTICA

Colonnina bicolore in PVC Ø mm 40, colorazione nella massa, corredato di cappello con anelli per aggancio catene.

CN93 - solo paletto (senza base) colore bianco/rosso, altezza cm 90

CN932 - solo paletto (senza base) colore giallo/nero, altezza cm 90

CN113 - solo paletto (senza base) colore bianco/rosso, altezza cm 110

CN1132 - solo paletto (senza base) colore giallo/nero, altezza cm 110

CN133 - solo paletto (senza base) colore bianco/rosso, altezza cm 130

CN1332 - solo paletto (senza base) colore giallo/nero, altezza cm 130

2 CORNICI PORTA CARTELLI

Le dimensioni base x altezza possono essere invertite. Fornite in kit di montaggio.

CNC3020 - cornice per cartelli, dimensioni mm 300 x 200

CNC3045 - cornice per cartelli, dimensioni mm 300 x 450

CNC3512 - cornice per cartelli, dimensioni mm 350 x 125

CNC5033 - cornice per cartelli, dimensioni mm 500 x 333

BASI DI SOSTEGNO

3 CN94 - base quadrata in gomma kg 1,5, dimensioni cm 27 x 27

4 CN95 - base rotonda in plastica, riempibile con acqua o sabbia, dimensioni h cm 8, Ø cm 30

5 CN92 - base triangolare moplencimento, kg 3



TRANSENNE componibili

Sistema versatile idoneo per transennare e delimitare aree interne ed esterne, composto da colonnine e barriere vendute in kit. Kit composto da: colonnine bianco/rosse in PVC con base appesantita, altezza 950 mm, Ø 50 mm, peso 6 kg + barre in PVC bianco/rosse mm 1200 x 100 x 20. Grazie all'anello circolare posto sulla sommità è possibile utilizzare le colonnine anche con catene in PVC (codici CP... - vedi pagina a fianco). Il porta cartello A4 ed il relativo accessorio per il fissaggio sulla colonnina sono fornibili separatamente.

6 CNVK2001 - kit 2 colonnine + 2 barriere

7 CNVK2002 - kit per estensione composto da 1 colonnina e 2 barriere

8 CNV4P - porta cartello in PVC formato A4 con bordo nero

9 CNV4S - supporto nero Ø 40 mm per portacartello, con biadesivo da fissare a palo



PALETTI, PALI, PARACARRO E BASI



PALETTI PARAPEDONALI

In ferro, verniciati a fuoco, con fasce autoadesive colorate e asole per catena. Con questi paletti è raccomandato l'uso delle catene in plastica (vedi pagina 296). **Altezza cm 85.**

- 1 **PAS30** - paletto rosso/bianco Ø 30 mm
- 2 **PAS302** - paletto giallo/nero Ø 30 mm
- 3 **PAB324** - base in ferro Ø 24 cm avvitabile per PAS30 e PAS302



PALETTI PARAPEDONALI

In ferro verniciati a fuoco con fasce bianche o nere in pellicola autoadesiva oppure in acciaio inox spazzolato. Asole per aggancio catena. Da interrare o utilizzare con le basi BC... **Altezza cm 120.**

- 4 **PAF48** - paletto rosso/bianco Ø mm 48
- 5 **PAF60** - paletto rosso/bianco Ø mm 60
- 6 **PAF482** - paletto giallo/nero Ø mm 48
- 7 **PAF602** - paletto giallo/nero Ø mm 60



6 PALETTI PARAPEDONALI ESTRAIBILI

In ferro verniciati a fuoco con fasce bianche in pellicola autoadesiva. Dotati di una bussola da interrare (a corredo), di asole per aggancio catena e anelli per eventuale inserimento di un lucchetto.

PASE48 - paletto rosso/bianco Ø 48 mm, altezza 120 cm

PASE60 - paletto rosso/bianco Ø 60 mm, altezza 120 cm

BUSSOLA DA INTERRARE

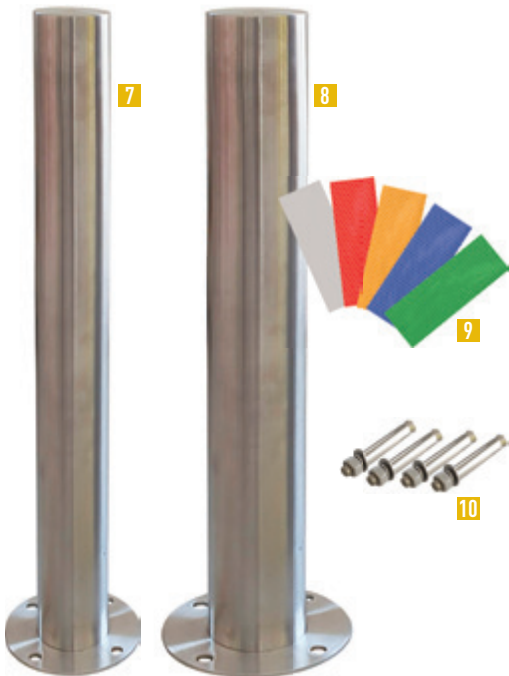

PALI IN ACCIAIO INOSSIDABILE

Materiale: acciaio inossidabile 316. Colore acciaio cromato. Altezza 800 mm. Testa piatta. Rifinitura lucida. Per uso interno ed esterno.

- 7 **BARV3168** - palo Ø 89 mm in acciaio inox AISI 316, base di fissaggio Ø 170 mm, spessore 5 mm (4 buchi Ø 12 mm). Peso 3,9 kg
- 8 **BARV3169** - palo Ø 159 mm in acciaio inox AISI 316, base di fissaggio Ø 240 mm, spessore 6 mm (4 buchi Ø 12 mm). Peso 11,2 kg
- 9 **BARV316** - set 2 pezzi bande riflettenti adesive per pali (abbinare lettera colore):
W bianco R rosso A arancio B blu G verde
- 10 **BARV316F** - viti per fissaggio base (4 pezzi)

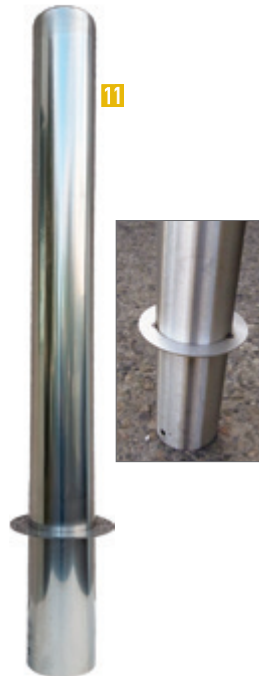

11 PARACARRO IN ACCIAIO INOX SATINATO

Paracarro per esterni dal design moderno e piacevole, con foro alla base per inserimento traversino. Rondella Ø 150 mm e cappellotto bombato saldati.

PAX1000 - paracarro in acciaio inox satinato, Ø tubo mm 100, altezza totale mm 1000 (800 fuori terra), peso kg 5

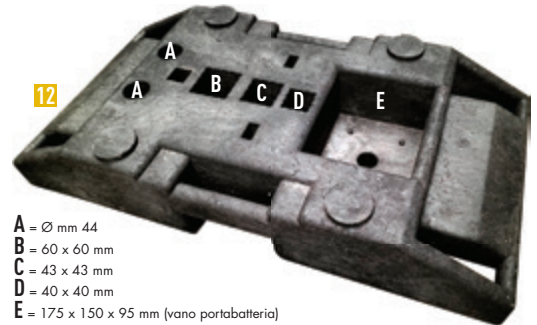

- A = Ø mm 44
- B = 60 x 60 mm
- C = 43 x 43 mm
- D = 40 x 40 mm
- E = 175 x 150 x 95 mm (vano portabatteria)

12 BASE DI APPESANTIMENTO PER PALO

In gomma riciclata, impilabile ed autobloccante. Dimensioni: mm 800 x 400 x 120.

BG028 - base appesantimento per palo, peso kg 28



BASI IN CEMENTO

Per paletti parapetonali. Base Ø cm 37 circa, peso kg 31.

- 13 **BC48** - base grigia con foro per palo Ø 48 mm, h cm 16
- 14 **BC60** - base grigia con foro per palo Ø 60 mm, h cm 16
- 15 **BC48R** - base rossa con foro per palo Ø 48 mm, h cm 16
- 16 **BC60R** - base rossa con foro per palo Ø 60 mm, h cm 16
- 17 **BC48Y** - base gialla con foro per palo Ø 48 mm, h cm 16
- 18 **BC60Y** - base gialla con foro per palo Ø 60 mm, h cm 16



BASI PERSONALIZZATE FORNIBILI A RICHIESTA. RICHIEDI UN PREVENTIVO!



PALO E GANCI

- 1 **PAA60** - palo in ferro verniciato grigio antracite Ø 60 mm, con asole saldate, testa a sfera Ø 70 mm. Spessore 2,5 mm. Peso kg 4,35, h 130 cm
- 2 **AGK3225** - confezione da 25 ganci a "S" in acciaio zincato per fissaggio catene ai paletti
- 3 **AGK3255** - confezione da 25 ganci a "S" in ferro verniciato grigio antracite, per fissaggio catene ai paletti PAA60



CATENE

- 4 **CMA355** - catena in ferro verniciato grigio antracite, dimensioni mm 5 x 35 x 22 in spezzoni da 3 m. Peso g 590/metro. A richiesta fornibili metrature in spezzone unico
- 5 **CMA35** - catena colore bianco/rosso mm 5 x 35 x 22 in acciaio zincato e verniciato, colore alternato ogni 50 cm in spezzoni da 3 m. Peso g 590/metro. A richiesta fornibili metrature in spezzone unico
- 6 **CMA352** - catena stesse caratteristiche della CMA35, colore giallo/nero



COLONNINA 4 VIE CON BASE FISSA

- Possibilità di aggancio catene su 2 livelli, 4 vie per ogni livello. Struttura in acciaio inox verniciato a polvere bicolore con base fissa in plastica rivestita in acciaio. Aggancio diretto alla colonnina o tramite gancio opzionale in polipropilene (2 pezzi inclusi con ogni colonnina). Altezza 1 m, peso kg 7,2.
- 7 **CNV112** - colonnina colore bianco/rosso Ø mm 50
 - 8 **CNV113** - colonnina colore giallo/nero Ø mm 50
 - CNV114** - coppia di ganci opzionali in polipropilene
 - 9 **CNV115** - kit 2 barre in PVC cm 120 x 10 h, colore bianco/rosso per utilizzo con colonnine



CORNICE PER COLONNINE IN ALLUMINIO COD. CNV4A A PAGINA 192.

COLONNINE CON NASTRO ESTENSIBILE PER USO INTERNO ED ESTERNO

Colonnine in acciaio inossidabile con nastro estensibile in polipropilene di lunghezza 210 o 430 mm. Idonee per delimitare aree ed indicare vie di circolazione. In colori altamente visibili, perfette per impiego industriale. Uso interno ed esterno. Il nastro rientra dolcemente grazie al sistema frizionato che permette un utilizzo sicuro. Altezza del nastro 50 mm.

- 10 **CNV50NJ** - colonnina giallo/nera Ø 51 mm, lunghezza nastro 210 cm, altezza 1014 mm, base Ø mm 320, peso 10 kg
- 11 **CNV50RB** - colonnina bianco/rossa Ø 51 mm, lunghezza nastro 210 cm, altezza 1014 mm, base Ø mm 320, peso 10 kg
- 12 **CNV80NJ** - colonnina giallo/nera Ø 80 mm, lunghezza nastro 430 cm, altezza 1100 mm, base Ø mm 360, peso 11 kg
- 13 **CNV80RB** - colonnina bianco/rossa Ø 80 mm, lunghezza nastro 430 cm, altezza 1100 mm, base Ø mm 360, peso 11 kg
- 14 **CNVP** - aggancio a parete per colonnine (completo di viti per il fissaggio)



SISTEMI DI DELIMITAZIONE AREE IN POLIPROPILENE



1 BARRIERA DI DELIMITAZIONE CON CATENE VERTICALI

Barriera di delimitazione composta da spezzoni di catena Ø 6 mm a maglie lunghe colore bianco-rosso, in polietilene ad alta densità. Ideale per identificare, in modo visibile ed efficace, il divieto di accesso ad un'area.

NVP136 - barriera di delimitazione con catene verticali da 50 cm, lunghezza 5 mt



3 COLONNA MODULABILE IN POLIPROPILENE

Ideale per delimitare aree esterne o interne, in modo permanente o temporaneo. Può essere fissata al suolo tramite viti per un utilizzo permanente o essere appesantita per un utilizzo temporaneo. Facilmente smontabile e modulabile mediante appositi segmenti per aumentare l'altezza standard di 85 cm. Fornita con i seguenti accessori: viti di montaggio del piedistallo/segmento, barra di montaggio/smontaggio segmenti, catena Ø 8 mm lunghezza 5 metri.

NVP109 - colonna in polipropilene modulabile colore bianco/rosso



2 GANCIO PER CONI STRADALI

Ideali per collegare tra loro due coni e creare così un'area di delimitazione. In polietilene, si adattano alla maggior parte dei coni grazie alle alette. Una volta fissati, i ganci possono ruotare su se stessi per avere il giusto orientamento.

NVP333 - confezione da 50 pezzi ganci per coni stradali



4 KIT PER DELIMITAZIONE PICCOLE AREE

La soluzione ideale per un piccolo cantiere o un'area di manutenzione. Il kit è costituito da:

- 5 coni in polietilene da 50 cm con 2 strisce adesive bianche
- 5 ganci a catena
- catena bianco/rosso Ø 8 mm, lunghezza 7,5 metri

NVP322 - kit per delimitazione piccole aree colore bianco/rosso



5 TESTINA TENDINASTRO PER CONI STRADALI

Soluzione ideale per creare una barriera di delimitazione flessibile ed efficace. Da posizionare su un cono altezza 75 cm o 1 m per una buona stabilità. La testina è dotata di 2 ganci che consentono il fissaggio di catene, nastri, attrezzi, etc.

NVP2833 - testina con nastro, lunghezza 3 metri x 50 mm

NVP2834 - testina con nastro, lunghezza 4 metri x 50 mm



6 BARRIERA TELESCOPICA PER CONI E COLONNA MODULABILE

Barriera telescopica salvaspazio che si adatta alla lunghezza desiderata (può essere allungata da 1 fino a 1,80 metri). Realizzata in PVC, pellicola bifacciale retroriflettente classe 1e 2 ganci per un facile fissaggio. Altezza: 150 mm. Solida, rigida, veloce da installare, si installa ovunque, in quanto non necessita di supporti specifici. Ideale per delimitare cantieri e per operazioni di manutenzione in generale.

NVP132 - barriera telescopica in PVC, estensibile fino a 1,80 mt, colore bianco/rosso



**BASE
RIBALTABILE!**



1 PALO IN PVC CON BASE RIBALTABILE

Palo in PVC colore bianco/rosso su base zavorrata da 4 kg. Ideale per creare delimitazioni temporanee, la base ribaltabile (A) permette un facile trasporto e stoccaggio in spazi ristretti.

NVP2000 - palo Ø 50 mm con base ribaltabile, altezza 900 mm

2 PALO IN PVC CON GANCI E BASE

Palo in PVC colore bianco/rosso con ganci a media altezza, su base zavorrata da 4 kg. Economico, molto stabile, estremamente resistente, ideale per delimitazioni temporanee.

NVP200932 - palo in PVC con ganci e base zavorrata da 4 kg

3 PALO IN ALLUMINIO CON GANCI

Palo in alluminio colore rosso con testa a 4 ganci per attacco a cordino o catena e base con 2 inserti rifrangenti (visibili di notte), da zavorrare con sabbia o ghiaia fino a 13 kg.

NVP202 - palo in alluminio con testa a 4 ganci Ø 60 mm, altezza 970 mm



PIASTRELLE TATTILI E LASTRE GUIDA PER NON VEDENTI E IPOVEDENTI

Piastrelle tattili e lastre guida bicolore per persone non vedenti e ipovedenti. Mettono in guardia contro i pericoli che possono incontrare durante il viaggio, come ad esempio incroci stradali, fermata dell'autobus, scale e banchine delle stazioni. Il bicolore offre un contrasto naturale per una migliore visibilità per le persone ipovedenti. Resistenti ai raggi UV, con indicatore di usura, per uso interno ed esterno: possono essere posate con colla poliuretanicca (preferibile per esterni) o con biadesivo (ideale per interni). La superficie piana e ruvida evita qualsiasi slittamento.

4 NVP1252BR - piastrella tattile colore bianco/rosso con cupole in rilievo Ø 25 mm, dimensioni 458 x 420 x 7,5 mm

5 NVP1252GN - piastrella tattile colore giallo/nero con cupole in rilievo Ø 25 mm, dimensioni 458 x 420 x 7,5 mm

6 NVP1252BN - piastrella tattile colore bianco/nero con cupole in rilievo Ø 25 mm, dimensioni 458 x 420 x 7,5 mm

7 NVP1255BR - lastra guida colore bianco/rosso con 4 strisce in rilievo h 5 mm, dimensioni 650 x 216 x 7,5 mm

8 NVP1255GN - lastra guida colore giallo/nero con 4 strisce in rilievo h 5 mm, dimensioni 650 x 216 x 7,5 mm

9 NVP1255BN - lastra guida colore bianco/nero con 4 strisce in rilievo h 5 mm, dimensioni 650 x 216 x 7,5 mm



BARRIERE IN LAMIERA, ACCIAIO E FERRO



1

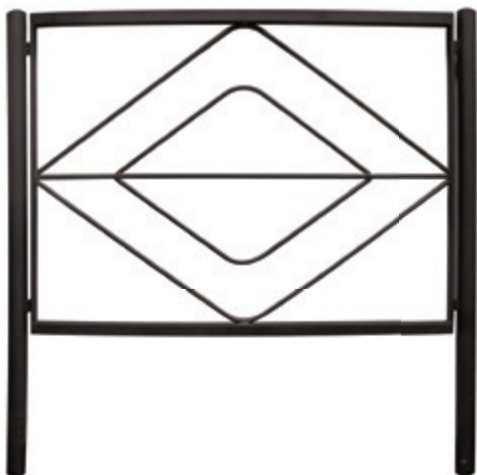

1 BARRIERA PARAPEDONALE VERNICIATA

Tubo in ferro Ø mm 48 quadro mm 30 x 30, verniciatura colore grigio micaceo. Peso kg 15 circa. Minimo ordinabile 5 pezzi/multipli.

TSP120 - barriera parapetonale cm 120 x 120 h



2



3



4

BARRIERE STRADALI COMPONENTI

Conformi alla fig. 392 del C.d.S. Barriera versione leggera: traversa in lamiera pressopiegata e verniciata ricoperta da una pellicola rifrangente classe 1 a strisce alternate bianche e rosse. Barriera versione pesante: in lamiera scotolata spessore 0,8 mm, verniciata a polvere con strisce bianche e rosse totalmente rifrangenti classe 1.

2 BTR120 - solo barriera versione leggera, cm 120 x altezza cm 20, peso kg 2,1

BTR150 - solo barriera versione leggera, cm 150 x altezza cm 20, peso kg 2,6

BFL150P - solo barriera versione pesante, cm 150 x altezza cm 20, peso kg 2,8

3 BGZ100 - gamba singola pieghevole versione leggera, in lamiera zincata. Altezza totale cm 100, peso 1,4 kg. Impiego: 2 per barriera

4 BGP150R - coppia di gambe non pieghevoli versione pesante per BFL150P, in ferro pieno a U verniciato a polvere colore rosso RAL3020, altezza cm 100, peso kg 2,4

5

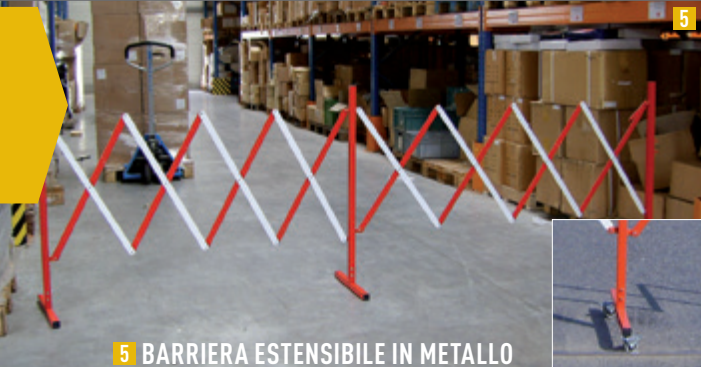

5 BARRIERA ESTENSIBILE IN METALLO

Estensibile fino a m 4, in acciaio verniciato a polvere, peso kg 16. Asta addizionale al centro della barriera per maggiore stabilità. Kit di 6 ruote addizionali e fornibili a corredo per una maggior praticità di utilizzo.

BARV400 - barriera estensibile colore bianco/rosso, dimensione aperta (h x l x b) cm 94 x 400 x 45.

BARV401 - kit di 6 ruote opzionali Ø mm 50

6



6 BARRIERE ESTENSIBILI PER USO DIURNO

BES230 - solo barriera estensibile in profilato di acciaio bianco/rosso composta da 12 bacchette mm 250, apertura max m 2,30, peso kg 2,6

BES300 - solo barriera estensibile in profilato di acciaio bianco/rosso composta da 16 bacchette mm 250, apertura max m 3,00, peso kg 3,8

BEG100 - gamba singola per barriere BES230 e BES300. Peso kg 1, h m 1,05 (impiego: 2 per barriera)

9



KIT DI ESTENSIONE DELLE BARRIERE

BARRIERE A 2 BARRE

Realizzate in acciaio verniciato composte da 2 pali Ø 50, h 1000 mm, con basi apesantite Ø 330 mm e da 2 barre da mm 1200 di lunghezza. Per comporre barriere della lunghezza desiderata, bisogna aggiungere il kit estensione composto da 1 palo e da 2 barre da mm 1200 di lunghezza.

7 BARV15BR - colonnina in acciaio verniciato bianco/rosso, barre in polipropilene colore rosso, dimensioni barriera mm 1100 x 1000 h, peso kg 19,5

BARV15EBR - kit di estensione composto da colonnina in acciaio verniciato bianco/rosso e barre in polipropilene colore rosso, dimensioni mm 1100 x 1000 h, peso kg 10,5

8 BARV15YN - colonnina in acciaio verniciato giallo/nero, barre in alluminio colore nero, dimensioni barriera mm 1100 x 1000 h, peso kg 19,5

BARV15EYN - kit di estensione composto da colonnina in acciaio verniciato giallo/nero e barre in alluminio colore nero, dimensioni mm 1100 x 1000 h, peso kg 10,5

9 BARV15S - colonnina in acciaio cromato, barre in acciaio inox, dimensioni barriera mm 1100 x 1000 h, peso kg 19,5

BARV15ES - kit estensione composto da colonnina in acciaio cromato e barre in acciaio inox, dimensioni mm 1100 x 1000 h, peso kg 10,5

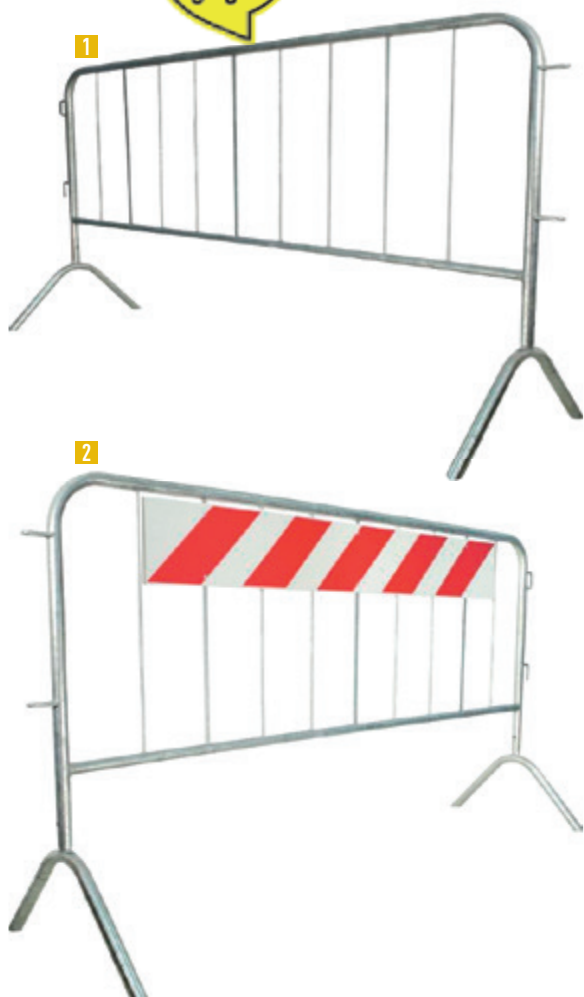

TRANSENNE

Transenne in tubo tondo e lamiera di ferro zincate a caldo. Fornite in due dimensioni, con e senza pannello rifrangente, complete di piedi orientabili e smontabili. Attacchi laterali anti sfilamento.

- 1 **TRS200** - transenna modulare mm 2000 x 1100
- TRS250** - transenna modulare mm 2500 x 1100
- 2 **TRS200R** - transenna modulare mm 2000 x 1100 completa di pannello rifrangente monofacciale mm 1200 x 200
- TRS250R** - transenna modulare mm 2500 x 1100 completa di pannello rifrangente monofacciale mm 1500 x 200



3 BARRIERA PARAPEDONALE

Barriera da interrare Ø mm 48 per delimitazione aree, in ferro zincato o verniciato. Colore: **W** verniciata bianca

A richiesta: **Z** zincata a caldo **Y** verniciata giallo

TSS100W - barriera parapedonale mm 915 x 1155 h

TSS200W - barriera parapedonale mm 1915 x 1155 h

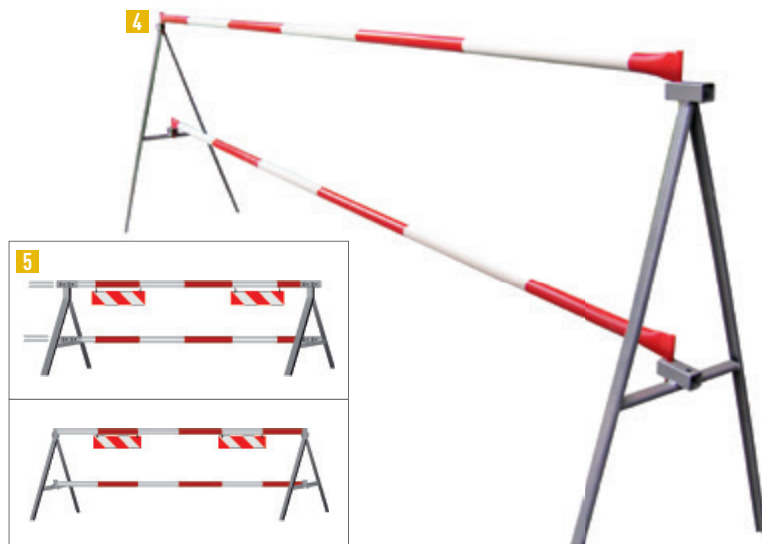

TRANSENNE componibili per sbarramenti

- 4 Tubi Ø mm 33, verniciati colore rosso con fasce bianche adesive, sostegni in ferro ad U.
 - TS33** - traversa m 3, Ø mm 33
 - TS30** - sostegno smontabile altezza mm 1000
 - TS60** - tabella alluminio piano mm 600 x 200 rifrangente classe 1
- 5 Tubi Ø mm 48, verniciati colore rosso con fasce bianche adesive, sostegni in ferro ad U pesante verniciati.
 - TS34** - traversa m 3, Ø mm 48
 - TS31** - sostegno smontabile altezza mm 1000
 - TS60** - tabella alluminio piano mm 600 x 200 rifrangente classe 1

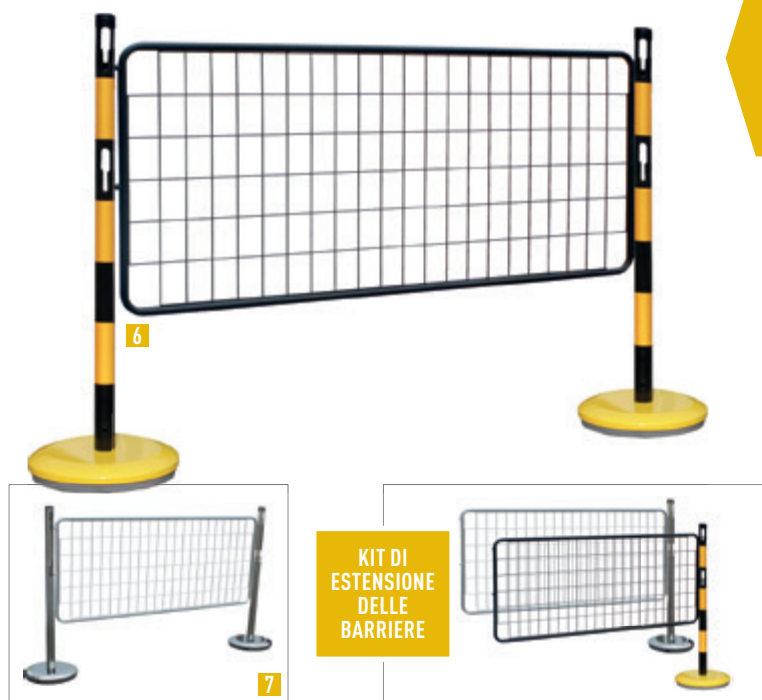

KIT DI ESTENSIONE DELLE BARRIERE

BARRIERE CON RETE METALLICA

In acciaio verniciato composte da 2 pali Ø 50, h 1000 mm con basi appesantite diametro 330 mm e da pannello in rete metallica mm 1500 x 650 h. Per comporre barriere della lunghezza desiderata, bisogna aggiungere il kit estensione composto da 1 palo e dal pannello in rete metallica dimensioni mm 1300 x 650 h.

- 6 **BARVR13YN** - barriera in acciaio verniciato giallo/nero con pannello in rete nero, mm 1500 x 1000 h, peso kg 24
- BARVR13EYN** - kit estensione acciaio verniciato giallo/nero con rete, mm 1500 x 1000 h, peso kg 16
- 7 **BARVR13S** - barriera acciaio con pannello in rete acciaio, dimensioni mm 1500 x 1000 h, peso kg 24
- BARVR13ES** - kit estensione acciaio con rete mm 1500 x 1000 h, peso kg 16



TRANSENNE E BARRIERE



TRANSENNA IN ALLUMINIO PER DELIMITAZIONE AREE LAVORO (D. LGS. 81)



Robusta transenna monofacciale ideale per utilizzi professionali frequenti. Peso e ingombro contenuti rendono questa transenna indispensabile per delimitare velocemente, in modo efficace, visibile, sicuro e pratico le aree di lavoro. Classificato Classe 1 resistenza al fuoco. Resistente struttura in alluminio, pannello in PVC con pittogrammi stampati su un lato facilmente identificabili. Misure transenna montata (1 modulo): cm 80 x 100.

Fornita smontata. Possibilità di acquistare i moduli già montati (richiedi preventivo).

- 1 BARS801P** - 1 modulo, peso kg 1,6, composto da:
 - 1 telo monofacciale in PVC cm 70 x 90 h, stampato "PERICOLO GENERICO"
 - 4 traverse (2 tubi verticali + 2 orizzontali)
 - 2 anelli di giunzione
 - 4 viti e 4 gommini
- 2 BARS801N** - 1 modulo, peso kg 1,6, composto da:
 - 1 telo monofacciale in PVC cm 70 x 90 h, stampato "ACCESSO VIETATO"
 - 4 traverse (2 tubi verticali + 2 orizzontali)
 - 2 anelli di giunzione
 - 4 viti e 4 gommini
- 3 BARS802** - base tonda per stabilizzare la barriera Ø mm 300, h mm 70
- 4 BARS803** - picchetto per stabilizzare la barriera Ø mm 35, lunghezza mm 400



5 BARRIERE componibili in polietilene ad alta densità (HDPE)

Base in materiale riciclato, appesantita (kg 20) con possibilità di aggiungere ulteriore peso aggiungendo acqua (+ kg 15). Disegnata per minimizzare i costi di trasporto. Ogni modulo viene fornito con banda rifrangente bianco rossa mm 760 x 145. Facile da installare anche da una sola persona, stabile e rigida in caso di urti. Il sistema di collegamento garantisce difficoltà in caso di smantellamenti da parte di persone non adatte ai lavori.

BAR0628A - modulo barriera in polietilene colore arancio, base nera. Dimensioni (l x p x h): mm 1080 x 520 x 1000, peso kg 24



ESTENSIBILE FINO A 2 METRI

6 BARRIERA ESTENSIBILE LEGGERA

Estensibile fino a 2 metri, con basi in gomma mm 390, h 1 metro. In polipropilene colore rosso e bande bianche retroriflettenti. Elementi opzionali aggiuntivi. Dimensioni chiusa: mm 390 x 340 x mm 1000 h.

BARV200 - barriera estensibile bianco/rossa con base nera, larghezza m 2,00 x h 1,00, peso kg 4,9

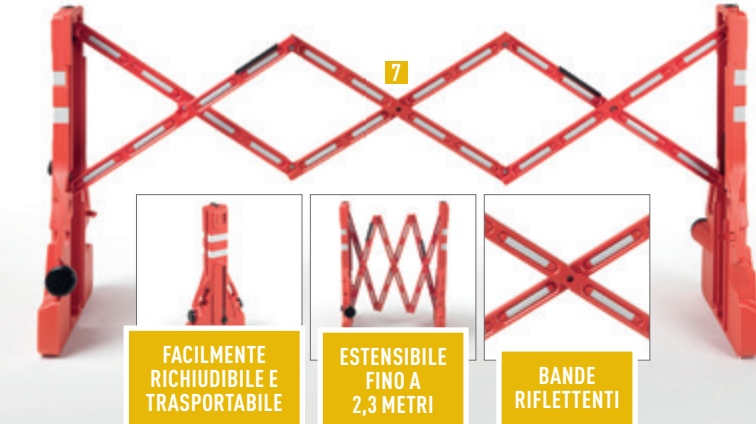

FACILMENTE RICHIUDIBILE E TRASPORTABILE



ESTENSIBILE FINO A 2,3 METRI



BANDE RIFLETTENTI

7 BARRIERA ESTENSIBILE IN POLIETILENE

Sbarra in modo rapido ed efficiente le aree di pericolo. Estensibile fino a 2,3 metri, con bande riflettenti. Molto stabile grazie alle ampie basi d'appoggio zavorrabili con acqua. Chiusura rapida, facilmente trasportabile grazie alla maniglia. Dimensioni chiusa: cm 47 x 13 x 107 h. Peso kg 6,5.

BARD230 - barriera estensibile fino a m 2,30, altezza m 1,07



SPESA DI TRASPORTO DA CONCORDARE

BARRIERA IN POLIETILENE, QUADRILATERO E MANUALE



1 BARRIERA IN POLIETILENE AD ALTA DENSITÀ (HDPE)

Stabile anche su terreni irregolari, sistema di collegamento per creare barriere intorno a cantieri temporanei o per delimitare il passaggio dei pedoni. Resistente e robusta, viene fornita completa di piedini e banda rifrangente bianca e rossa mm 1200 x 145. Pallet da 50 pezzi.

BAR0635A - barriera in polietilene ad alta densità colore arancio. Dimensioni: mm 2000 x 1000 h, peso kg 10



4 FORI PER APPLICAZIONE CARTELLI



CONTENITIVE E NON PERICOLOSE!



FACILMENTE IMPILABILI!



BARRIERA QUADRILATERO

Sistema modulare per delimitare aree di cantiere costituito da pannelli di rete in polietilene, avvolti su struttura metallica rivestita con doppio trattamento di polveri termoindurenti. Robusto, inalterabile nel tempo, non arrugginisce, protegge i pedoni e crea corridoi di transito. Se utilizzato nelle ore notturne o in condizioni di scarsa visibilità, dovrà essere corredato da tabella in alluminio a strisce bianco/rosse (A) rifrangente classe 1 (a richiesta) e luce rossa fissa di segnalazione (B) sulla parte frontale (codice LAF119R). A richiesta elemento di giunzione per l'utilizzo in linea di più sistemi modulari. **Approvato dal Ministero delle Infrastrutture e dei Trasporti.**

2 RLM1004 - trasenna composta da 4 moduli da cm 100 x 100, peso kg 13,5

3 RLM100P - piedino piatto per posa in linea (5 pezzi necessari per RLM1004)

RLM100S - picchetto per posa in linea interrata (5 pezzi necessari per RLM1004)

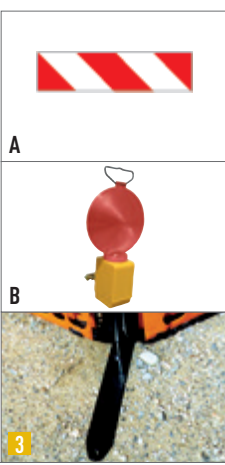

4 BARRIERA QUADRILATERA AD ALTA DENSITÀ (HDPE)

Barriera portatile in polietilene ad alta densità con banda rifrangente su ogni lato. Composta da 4 moduli, per delimitare zone di lavoro temporanee. leggera per una facile installazione. Delimita le zone di pericolo per evitare che pedoni o addetti ai lavori entrino in zone in cui l'accesso non è consentito.

BAR9738Y - barriera in polietilene ad alta densità colore giallo con banda rifrangente, mm 3000 x 1000 h, peso kg 8

BAR9738P - base opzionale nera per configurare la barriera a quadrato, mm 340 x 340 x 80 h, peso kg 2,6



5 BARRIERA MANUALE

In lamiera di ferro e tubolare di alluminio, con piedino pensile o fisso, verniciatura a polvere di colore rosso. Facile da aprire e chiudere grazie alla barriera trasversale. Chiusura di sicurezza mediante chiovetto lucchettabile. Barra in alluminio fornibile in diverse lunghezze (mt. 3 - 4 - 5 - 6) con inserti in pellicola rifrangente classe 1. In fase d'ordine aggiungere dopo i codici BARS41P e BARS41F la lunghezza barra desiderata (es. BARS41P3).

BARS41P. - barriera piedino pensile con barra alluminio (precisare lunghezza barra max 6 mt)

BARS41F. - barriera piedino fisso a murare con barra alluminio (precisare lunghezza barra max 6 mt)

ELEMENTI BARRIERA

- piastra di ancoraggio: cm 25 x 35 x 1 h
- piedistallo portante: cm 24 x 12 x 98 h
- contrappeso: cm 48 x 8, spessore 1
- lunghezza barriera: cm 99
- sezione barra in alluminio: cm 100 x 4, spessore 2 mm



BARRIERE, RAMPE E PANNELLI DI SEGNALAZIONE



1 BARRIERA IN POLIETILENE PER INTERNI

Per delimitare e proteggere aree di lavoro occasionali. Tubolare in polietilene Ø 26 mm, composta da 3 pannelli in poliestere di colore giallo con simbolo "NO ENTRY". Modulo opzionale per allungamento barriera comprensivo di 2 ganci di collegamento. Leggera e stabile.

BARV170 - barriera 3 moduli, dimensioni (h x l) cm 100 x 170, peso kg 3,2

BARV171 - modulo opzionale, dimensioni (h x l) cm 100 x 57, peso kg 1,1



2 QUADRILATERO PER CHIUSINI

Conforme alla figura 402 del C.d.S. serve per delimitare e segnalare chiusini o altro tipo di portello aperto. Struttura in tubo Ø mm 15, verniciatura a fuoco colore rosso, smontabile e chiudibile. Tabelle perimetrali in lamiera cm 100 x 15 spessore mm 0,8 con strisce diagonali bianco/rosso totalmente rifrangenti classe 1.

QDT150 - quadrilatero cm 100 x 100 x 100 h. Peso totale kg 12 circa



GLI OCCHI DI GATTO AUMENTANO LA VISIBILITÀ NOTTURNA!

3 PANNELLO DI SEGNALAZIONE

Pannello di segnalazione in gomma di colore nero con 4 frecce di colore giallo integrate con microsfere di vetro rifrangenti e 15 occhi di gatto Ø 10 mm posizionati tra le frecce per aumentare la visibilità nelle ore notturne. Il pannello si fissa con estrema facilità, a seconda della superficie, i due modi: con la speciale colla codice PGRV17 (venduta separatamente) o con 6 viti incluse nella fornitura.

PAV1200 - pannello in gomma nero con frecce gialle, dimensioni (l x l x h) mm 1200 x 400 x 8, peso 4,6 kg

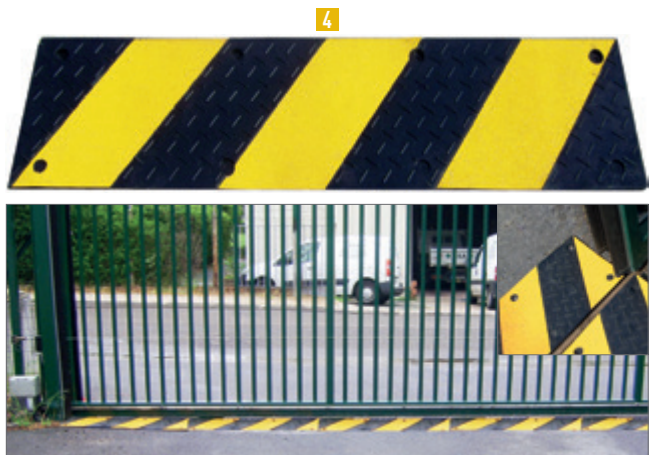

4 RAMPA DI SEGNALAZIONE CANCELLO

Rampa per cancello realizzata interamente in gomma di colore giallo e nero, posizionata anteriormente e posteriormente al binario dove scorre il cancello, può essere utilizzata sia come protezione dello stesso che come rallentatore di velocità. Per la posa in opera è consigliata la colla codice PGRV17 e 8 viti per cemento codice PGRV26 (opzionali).

DATV1200 - rampa per cancello, dimensioni (l x l x H) mm 1200 x 300 x 6/15, peso kg 5

PGRV26 - sistema di fissaggio per cemento, mm 80 x Ø mm 12, peso 70 g



BARRIERA LEGGERA PER AREE DI LAVORO TEMPORANEE

Per circoscrivere e salvaguardare aree di lavoro provvisorie. Tubolare in PVC, composta da 3 pannelli neutri di colore giallo in poliestere. Modulo accessorio per allungamento barriera comprensivo di 2 ganci di collegamento. Leggera e stabile, facile da trasportare e installare.

5 BARV180 - barriera 3 moduli, dimensioni (h x l) cm 180 x 170, peso kg 6

6 BARV181 - modulo opzionale, dimensioni (h x l) cm 180 x 60, peso 2 kg





Dispositivi di tutela parcheggio su area privata chiusa al transito pubblico

Trattamento di elettrozincatura anticorrosione, calotta in poliammide - caricata con fibra di vetro - a protezione dei piedi di fissaggio, serratura a chiave con cilindro a profilo europeo, blocco automatico al ritorno manuale in posizione verticale, imballaggio individuale in cartone completo di viti e tasselli e due chiavi (fornibili a richiesta con serrature e chiavi uguali).



- 1 **ASR700** - colonnina di tutela parcheggio con possibilità di chiusura in posizione abbassata. Dimensioni Ø mm 204 x 900, dimensioni colonnina mm 60 x 60
- 2 **ASR100** - fungo di tutela parcheggio con possibilità di chiusura in posizione abbassata. Dimensioni mm 730 x 500 x 204, dimensioni colonnina mm 60 x 60
- 3 **ASR580** - archetto con terza vite supplementare antifurto. Dimensioni mm 940 x 460 h, dimensioni tubo: Ø mm 50
- 4 **ASR050** - archetto con possibilità di chiusura alla base con lucchetto (incluso). Ingombro mm 465 x 490 h, dimensioni tubo: Ø mm 42,5



5 FLEXIBLE PARKING HOOP

Archetto dissuasore di parcheggio con molla ad alta resistenza che impedisce il danneggiamento della vettura in caso di collisione. Acciaio zincato, spessore 20/10. Piedi in acciaio galvanizzato a caldo. Elementi di fissaggio inclusi.

ASV650Y - archetto di parcheggio giallo mm 970 x h 650, tubo Ø 60 mm, peso 16 kg, con chiavi diverse



6 ARCHETTI ANTISOSTA ABBATTIBILI

Per posto macchina, tubo Ø 33 mm in acciaio verniciato. Possibilità di applicazione lucchetto (non fornito). Fissaggio al suolo mediante tasselli (non forniti).

AS119 - archetto antisosta verniciato giallo, dimensioni (b x h) cm 49 x 52



7 DISPOSITIVO DI TUTELA PARCHEGGIO

Utilizzo in parcheggi su area privata chiusa al pubblico e al transito. Costruzione in tubi di acciaio, dimensioni tubi: tondo Ø 50 mm/quadro interno 50 x 50 mm/quadro esterno 55 x 55 mm. Trattamento anticorrosione: zincatura a caldo. Piede di fissaggio realizzato in ghisa con trattamento anticorrosione zincatura a caldo. Sistema di fissaggio: viti, tasselli, rondelle (incluso). Sistema di chiusura: cilindro profilo europeo, 3 chiavi incluse. Blocco automatico al ritorno manuale in posizione verticale. Bande rifrangenti.

ASR480 - dispositivo di tutela del parcheggio abbattibile, dimensioni 870 mm (esterno 960) x 380,6 mm x h 450 mm (l x l x h), peso kg 11



8 COLONNINA ANTISOSTA

Completamente pieghevole con serratura a chiave triangolare che limita l'accesso a strade o passaggi. In alluminio spessore 2 mm, base in ghisa e due bande rosse riflettenti applicate sul tubo, anello per eventuale aggancio catene. 2 elementi di fissaggio per cemento Ø 10 mm inclusi.

ASV600 - colonnina antisosta in alluminio, chiave 11 mm, dimensioni (L x l x h) mm 60 x 30 x 940, peso kg 4,80

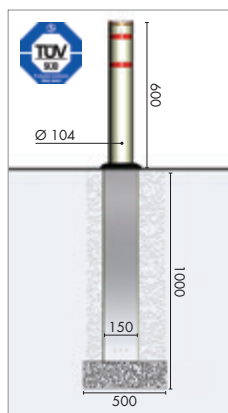

9 PALO RETRAIBILE TUTELA PARCHEGGIO

Per autovetture o delimitazione aree private. Tubo tondo in acciaio inox AISI 304 elettrolucidato, contenitore (tubo quadro) è in ferro zincato a caldo. Componenti interni ed esterni in acciaio inox AISI 304. Ottima resistenza agli agenti atmosferici. L'azionamento manuale consente l'installazione anche in luoghi non serviti elettricamente.

ASR860 - palo retraibile ad azionamento manuale con chiavi diverse



10 ARCHETTO ANTISOSTA AUTOMATICO PER PORTATORI DI HANDICAP

Arco di parcheggio automatico con batteria ricaricabile che evita di dover scendere dal veicolo per aprirlo o chiuderlo. Allarme acustico in caso di un urto. 2 strisce riflettenti classe 1. Autonomia batteria: 2 mesi (senza sole), tempo di ricarica 2h. Con 2 telecomandi, velocità di apertura/chiusura: 5/6 secondi. Temperatura di utilizzo -5°C/+40°C. Fissaggi inclusi.

ASV601 - archetto antisosta in acciaio zincato mm 600 x 400 (l x h), tubo Ø 38 mm, peso kg 5,85



DISSUASORI DI SOSTA E ARCHETTI PARAPEDONALI



1 PALETTA PARAPEDONALE ECOLOGICO

Realizzato in conglomerato gommoso-resinoso di **gomma riciclata**, stampato a freddo. Privo di spigoli, non arrugginisce, rispetta l'auto e l'ambiente. Da utilizzare per delimitazione spazi vietati alla sosta e altri vari, separazione tra traffico pedonale, ciclabile e veicolare, ecc. Disponibile, **con un acquisto minimo di 10 pezzi**, anche nei colori: grigio metallizzato, verde, granata e blu elettrico (2 bande gialle rifrangenti fornite sempre a corredo). Peso 15 kg circa. Posa su cemento con tubo metallico con piastra e viti (forniti). Per la posa su asfalto sono necessari tasselli chimici (non inclusi nella fornitura). Dimensioni: mm 250 x 780 (b x h).

ASR1000A - dissuasore di sosta in gomma grezza colore antracite

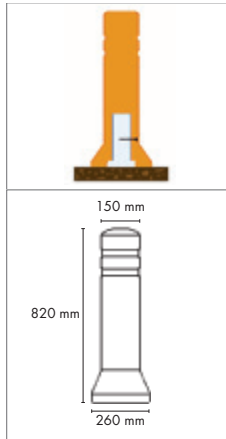

1

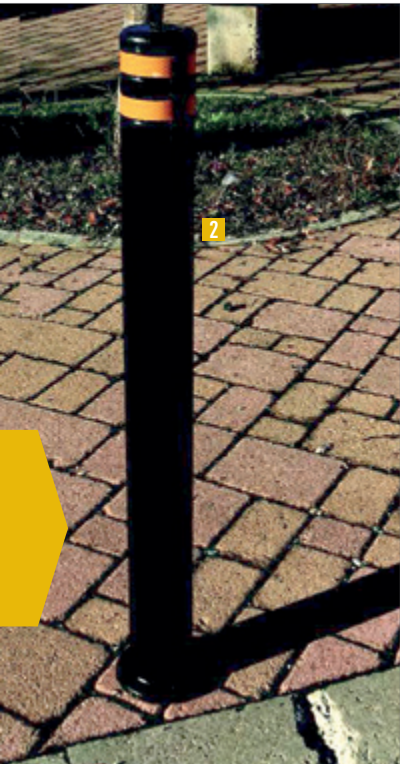

2



INTRODURRE IL PALETTA E RUOTARE DI 90°

3



DISSUASORE DI SOSTA FLESSIBILE

Dissuasore di sosta in elastomero poliuretano. Minimizza, in caso d'urto, i danni mantenendo inalterate forma e funzioni originarie. Sicuro, autoestinguente, duraturo, non richiede manutenzione. L'inserimento di due fasce rifrangenti ne garantisce la visibilità anche nelle ore notturne. **Inghisabile al suolo come un normale paletto metallico**. A richiesta per quantità fornibile nei colori: giallo, verde e rosso.

2 BAR115 - dissuasore di sosta flessibile colore nero Ø 90, altezza 1150 mm

3 BAR115B - base sfilabile in gomma riciclata per paletto BAR115 (opzionale)

4

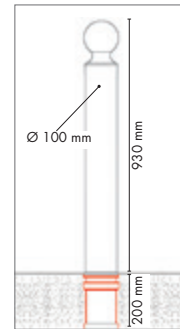

5



PALETTA PARAPEDONALE IN POLIURETANO ESTRAIBILE

Elemento discreto dell'arredo urbano, è essenziale per separare le zone di viabilità automezzi da quelle riservate al traffico pedonale. Realizzato in poliuretano, principale caratteristica del prodotto, assorbe in modo ottimale gli urti senza rotture. La boccia in poliuretano consente di estrarre il paletto e di re-inserirlo a seconda delle necessità. Resistente a temperature da -20°C a +70°C.

4 BARV810 - paletto nero testa tonda Ø 100, h totale cm 113 (di cui 20 da interrare), peso kg 4,5

5 BARVPB - boccia per paletto estraibile in poliuretano, peso 14 kg

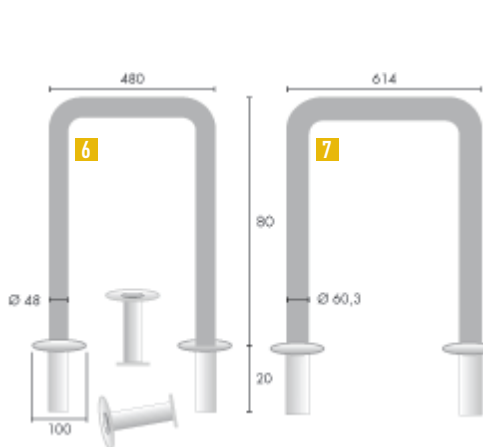

ARCHETTI IN ACCIAIO INOX SPAZZOLATO

6 AS134 - archetto in tubo inox Ø 48 mm, h totale cm 100 (80 fuori terra) con rondelle non saldate

ASE134 - archetto estraibile, in tubo inox Ø 48 mm, con bussola a corredo, dotate di foro per lucchetto (non fornito)

7 AS136 - archetto in tubo inox Ø 60,3 mm, altezza totale cm 100 (80 fuori terra) con rondelle non saldate

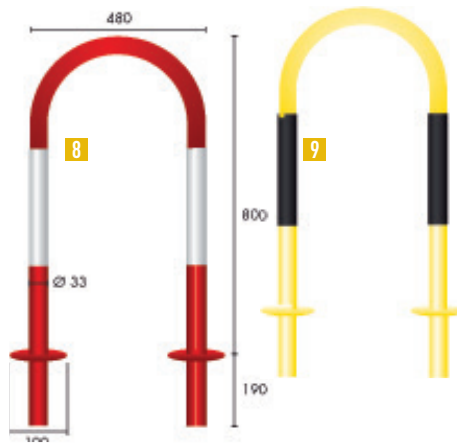

ARCHETTI IN TUBO ACCIAIO VERNICIATO

Con fasce autoadesive bianche o nere. Dotate di foro per lucchetto (non fornito).

8 AS121 - archetto bicolore rosso/bianco

9 AS122 - archetto bicolore giallo/nero

10 AS120 - archetto monocolor giallo

11 AS123 - archetto monocolor rosso

12 AS012 - bussola da interrare verniciata colore grigio. In quantità di 2, unita agli archetti, rende gli stessi estraibili



10

11

12



1

SPese DI TRASPORTO DA CONCORDARE

1 BARRIERA STRADALE TIPO NEW JERSEY IMPILABILE

Per la delimitazione di traffico su strade, autostrade, grandi aree, parcheggi, rotonde. Resistente ai raggi UV e agli urti. Possibilità di inserire catarifrangente su ambo i lati (non fornito) per aumentare visibilità e sicurezza in caso di scarsa illuminazione. Tramite sistema di fissaggio immediato (maschio-femmina) consente la realizzazione di configurazioni lineari, curvilinee e altre forme. Tappo filettato di carico posto nella parte superiore e tappo filettato di scarico posto in basso centralmente mediante il quale si può scaricare la zavorra (acqua o sabbia). Ogni unità ha un livello massimo di riempimento segnalato da apposito indicatore.

NJT070R - barriera New Jersey 100% polietilene atossico, colore rosso di alta qualità, dimensioni mm 100 x 70 h

NJT070W - barriera New Jersey 100% polietilene atossico, colore bianco di alta qualità, dimensioni mm 100 x 70 h



2

2 DELINEATORE CURBFIX CON BASE IN GOMMA

Realizzato in gomma, base con profilo convesso 2 inserti rifrangenti di colore giallo dimensioni cm 29 x 90 x 5, cilindro Ø cm 8 x 60 altezza, interamente rifrangente classe 2. Di facile posa tramite tasselli non inclusi nella fornitura (2 pezzi necessari).

DFS721 - delineatore altezza cm 60, rifrangente classe 2

DAT024 - tassello di fissaggio HBR 10 - 120



4

DELIMITATORE DI CORSIA RISERVATA

Cordolo **omologato** adatto a separare corsie riservate. Composto da un elemento centrale con inserti rifrangenti su entrambi i lati e due elementi terminali maschio e femmina, dotati sulla testa di inserti rifrangenti microprismatici ad alta retroriflessione. Realizzato interamente in gomma, rivestito con poliuretano resistente agli UV e alla lacerazione. Il fissaggio al suolo è previsto mediante tasselli a espansione, da ordinare separatamente.

3 COT500 - cordolo centrale di delimitazione h 5 cm, dimensioni 100 x 16 x 5 cm

4 COT500M - terminale maschio per cordolo h 5 cm, dimensioni 45 x 16 cm

5 COT500F - terminale femmina per cordolo h 5 cm, dimensioni 45 x 16 cm

DAT6006 - tassello di fissaggio Ø mm 10 x 120 h, tirafondo in acciaio ad alta resistenza mm 7 x 120, rondella mm 8 x 24 (3 pezzi per elemento centrale e 2 pezzi per ogni terminale)



10

8

7

9

CORDOLO DELINEATORE DI CORSIA

Cordolo **omologato** adatto a separare corsie riservate. Interamente in gomma, rivestito con poliuretano. Composto da elemento centrale con inserti rifrangenti su entrambi i lati, due elementi terminali maschio e femmina con inserti rifrangenti microprismatici ad alta retroriflessione e delineatore cilindrico in gomma con due fasce rifrangenti. Il cilindro è inserito a baionetta e di facile sostituzione (in caso di danneggiamento) senza rimuovere il cordolo. Fissaggio al suolo con barre filettate e tasselli, da ordinare separatamente (malta chimica opzionale raccomandata). **Per l'installazione di ogni terminale sono necessari 1 tassello DAT6002 e 1 tirante DAT6007.**

7 COT100 - cordolo centrale di delimitazione 100 x 30 x h 10 cm

8 COT100D - delimitatore cilindrico 70 x h 33 cm per COT100

9 COT100M - terminale maschio 62,5 x 30 cm per COT100

10 COT100F - terminale femmina 62,5 x 30 cm per COT100

DAT6007 - tirante interamente filettato in acciaio C40 zincato M 14x240 dado e rondella (2 per cordolo)

DAT6002 - 1 tassello 14 x 140 completo di tirafondi e rondella



CONI SEGNALETICI, TENDINASTRO E ACCESSORI PER CONI



POSSIBILITÀ DI PERSONALIZZAZIONE. RICHIEDERE PREVENTIVO.

CONI SEGNALETICI

In polietilene, bicolore e monocolore.

- 1 **COR81** - cono rosso/bianco, peso g 640. Dimensioni (b x h): cm 28 x 50
- 2 **COR81R** - cono rosso con strisce bianche rifrangenti verniciate, base pesante in gomma, peso g 1850. Dimensioni (b x h): cm 27 x 50
- 3 **COR82** - cono giallo/nero, peso g 640. Dimensioni (b x h): cm 28 x 50
- 4 **COR83** - cono rosso/bianco, peso g 375. Dimensioni (b x h): cm 23 x 30
- 5 **COR85** - come sopra giallo/nero
- 6 **COR84** - cono rosso fluo, peso g 375. Dimensioni (b x h): cm 23 x 30
- 7 **COR86** - come sopra monocolore giallo



8



KIT CONI E CATENA PER DELIMITAZIONE PICCOLE AREE A PAGINA 300.

8 CONI STRADALI CM 100

Base in PVC riciclato mm 540 x 540, corpo in High Density Polyethylene (HDPE) altezza mm 1000 e banda rifrangente altezza mm 380 classe 2. Ideali durante i lavori stradali e per la delimitazione di corsie. Utilizzabili con la fune di tela a 3 fili ad alta visibilità combinata con un componente 3M retroriflettente.

- COR9100** - cono mm 540 x 1000 altezza, peso 7 kg
- COR994F** - fune 18 m con punti di aggancio/sgancio ogni 4,2 m



PVC MORBIDO

CONO SEGNALETICO IN PVC MORBIDO

Coni segnaletici in PVC morbido, base in caucciù rinforzata, 2 bande rifrangenti classe 2. Fornibili in altezze diverse e nel colore giallo.

- 9 **CORV47** - cono bianco/rosso, mm 360 x 360 x 900 h, peso kg 4,8
- CORV47Y** - cono come CORV47, colore giallo
- 10 **CORV46** - cono bianco/rosso, mm 360 x 360 x 750 h, peso kg 3,1
- 11 **CORV45** - cono bianco/rosso, mm 270 x 270 x 500 h, peso kg 1,5



TESTINA TENDINASTRO TENSACONE

Corpo in plastica robusto, antiurto, si fissa ad incastro sui cono in commercio (utilizzo raccomandato con cono COR78 e COR55). Con nastro in polietilene ad alta visibilità a righe bianco/rosso da m 4 x 5 cm h, atte a ricevere 3 punti di aggancio. Creato per costruire semplicemente e in pochi istanti una barriera.

- 12 **BAR9945** - testina tendinastro con nastro da m 4 colore bianco/rosso
- 13 **COR78** - cono rifrangente classe 2 in gomma cm 40 x 78 h, peso kg 5,5
- COR55** - cono rifrangente classe 2, cm 27,5 x 27,5 x 55 h, peso kg 2,5



ACCESSORI PER CONI

- 14 **CORV40** - confezione da 5 anelli in polipropilene con asole per attacco catenelle, per cono di diversi formati. Dimensioni mm Ø 95 x 28 h
- 15 **CORV41** - kit barriere per cono, include: coppia di barriere in polipropilene colore bianco/rosso, bande riflettenti classe 1, 4 fascette, elementi di fissaggio. Dimensioni barriere: mm 1200 x 100, spessore mm 20, peso 1,5 kg



FORNIBILI A RICHIESTA ADESIVI PER CONO. RICHIEDI UN PREVENTIVO!

16 CONO SEGNALE DA PAVIMENTO

Cono di segnalazione di avviso e pericolo in PVC, con base appesantita in gomma colore nero, personalizzabile con appositi adesivi raffiguranti simbologie ISO7010 (dove contemplate).

- CORV90** - cono da pavimento colore giallo, dimensioni mm 360 x 360 x 900 h, peso 4,8 kg



1



1 CONO RETRATTILE

Cono retrattile con fasce riflettenti ad alta intensità. Stabile, grazie alla base resistente e pesante, facilmente trasportabile e di poco ingombro. Adattabile a qualsiasi situazione di strada e di traffico. Fornito con custodia (A).

CORV50 - cono retrattile, dimensioni: base mm 310 x 310, altezza totale mm 620, peso kg 1,3 con dispositivo luminoso (B) da applicare sulla parte superiore del cono (batterie incluse)

CORV70 - cono retrattile, dimensioni: base mm 310 x 310, altezza totale mm 750, peso kg 2,5, con dispositivo luminoso fisso interno al cono (batterie incluse)

Coni e delineatori

Conformi alle Figure 396 e 397 del C.d.S. e Art. 34 del Reg. Att. C.d.S. in termini di visibilità notturna.



2

3

4

5

6

7

2 CONO RIFRANGENTE

Cono stradale in gomma con 2 fasce rifrangenti classe 2.

COR30 - cono rifrangente altezza 30 cm

CONI RIFRANGENTI OMOLOGATI

Coni stradali **omologati** in gomma con 2 o 3 fasce rifrangenti classe 2. **Omologazione come da disciplinare tecnico cantieristica del 10/07/02.**

3 COR32 - cono a 2 fasce rifrangenti, altezza 32,6 cm

4 COR55 - cono a 3 fasce rifrangenti, altezza 54 cm

5 COR78 - cono a 3 fasce rifrangenti, altezza 78 cm

DELINEATORI FLESSIBILI

Delineatori flessibili di corsia con inserti rifrangenti (rifrangenza cl. 2).

6 DFR34 - delineatore stradale flessibile di corsia cilindrico, completo di 2 fasce rifrangenti classe 2, base in gomma tassellabile al suolo, altezza 33 cm

7 DFR33 - delineatore stradale flessibile di corsia lamellare con 6 inserti rifrangenti, **omologato**, altezza 33 cm



8



9



10

8 DELINEATORE CILINDRICO IN PLASTICA ALTEZZA CM 75

Delineatore realizzato in polietilene altamente resistente agli agenti atmosferici, flessibile e dotato di 2 fasce rifrangenti per una perfetta visibilità notturna. Utilizzato per delimitare corsie. Fissaggio a terra mediante DAT6006 (non inclusi nella fornitura), che si applicano con chiave a "T" non fornita.

DFS221 - delineatore cilindrico Ø cm 20, altezza cm 75, con 2 fasce rifrangenti High Intensity Grade

9 DELINEATORE CILINDRICO IN GOMMA ALTEZZA CM 60

Realizzato in gomma vulcanizzata ad elevata elasticità resistente agli urti e schiacciamenti. Pellicola rifrangente H.I. a garanzia di elevata visibilità notturna. Utilizzato per evidenziare zone di lavoro con durata superiore ai due giorni. Certificato secondo il C.d.S.

DFS321 - delineatore cilindrico Ø cm 8, altezza cm 60, 3 fasce rifrangenti High Intensity Grade

10 COLLANTE PER DELINEATORI IN GOMMA

Collante bituminoso rapido a base solvente per incollaggio delineatori su pavimentazioni stradali. Applicabile mediante spatola o cazzuola. La base del delineatore deve essere pulita da eventuali tracce di collanti, da sporco e sostanze estranee. La pavimentazione stradale deve essere pulita da materiali come sassi e briciole. Consumo: da 30 a 50 delineatori per confezione. Applicazione: temperatura ambientale minimo +5°C / max +40°C.

DFS200 - collante per delineatori da 5 kg



RALLENTATORI DI VELOCITÀ E PROFILI DI DELIMITAZIONE



Rallentatori di velocità

Ideali per rallentare la velocità dei veicoli, anche pesanti, in aree private. In gomma riciclata, elevata resistenza ai raggi UV, agli oli e agli acidi, alle temperature da -40°C a +80°C. A strisce nere e gialle, alta visibilità garantita dagli 8 occhi di gatto inclusi. Due scanalature Ø 30 mm assicurano il drenaggio di liquidi o il passaggio di cavi. A corredo fornibili elementi terminali.



RALLENTATORI DI VELOCITÀ 1830 mm

Forniti con elementi di fissaggio per l'asfalto.

- 1 DATV55** - rallentatore mm 1830 x 300 x 55 (l x l x h), peso kg 28 (per zona 20 - 25 km/h)
- DATV75** - rallentatore mm 1830 x 300 x 75 (l x l x h), peso kg 45 (per zona 5 - 10 km/h)
- 2 DATV50** - elemento terminale (1 pezzo) mm 250 x 300 x 55 (l x l x h) per DATV55, peso kg 2,5 (per zona 20 - 25 km/h)
- DATV76** - elemento terminale (1 pezzo) mm 250 x 300 x 75 (l x l x h) per DATV75, peso kg 4 (per zona 5 - 10 km/h)
- 3 DATV55A** - accessorio di giunzione opzionale mm 85 x 45 x 20 (ottimizza resistenza e tenuta dei moduli tra loro) per DATV55 e DATV75

RALLENTATORI DI VELOCITÀ CON PASSACAVI 500 mm

Forniti SENZA elementi di fissaggio per l'asfalto.

- 4 DATV54** - rallentatore mm 500 x 300 x 55 (l x l x h), peso kg 6,2 (per zona 25 - 30 km/h)
- DATV74** - rallentatore mm 500 x 300 x 75 (l x l x h), peso kg 8,5 (per zona 5 - 10 km/h)
- 5 DATV56** - elemento terminale (1 pezzo) mm 150 x 300 x 55 (l x l x h) per DATV54, peso kg 1,3 (per zona 25 - 30 km/h)
- DATV70** - elemento terminale (1 pezzo) mm 200 x 300 x 75 (l x l x h) per DATV74, peso kg 2,9 (per zona 5 - 10 km/h)
- 3 DATV55B** - accessorio di giunzione opzionale mm 50 x 30 x 15 (ottimizza resistenza e tenuta dei moduli tra loro) per DATV54 e DATV74



6 RALLENTATORE DI VELOCITÀ PORTATILE EASYROLL

Rallentatore di velocità portatile realizzato in poliuretano, da utilizzare a scopo temporaneo. Non richiede installazione, può essere trasportato facilmente e spostato da un luogo all'altro. Ideale per rallentare il traffico in certi orari o circostanze (ad esempio incidenti) da evidenziare con opportuna segnaletica. Facile da trasportare nella sua borsa (A) grazie al peso contenuto, 12 kg. Bande adesive retroriflettenti classe 2 ogni metro. Portata: 20 t.

DATV250 - rallentatore mm 3000 x 250 x 40 altezza, velocità max km/h 30. Dimensione piegato: mm 360 x 250 x 350

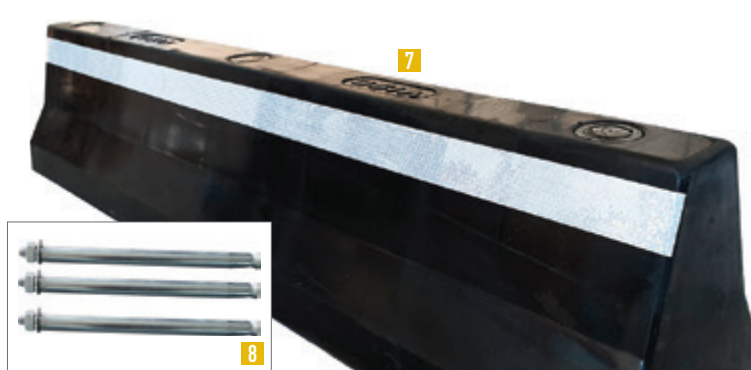

PROFILI DI DELIMITAZIONE AREE PER CARRELLI ELEVATORI

Profilo di protezione utilizzato per delimitare le aree di parcheggio, ideale anche per la tutela delle aree di stoccaggio durante il passaggio dei muletti. Realizzato in gomma con strisce riflettenti. Fissaggio tramite 3 tasselli (fornibili a corredo) da inserire con una profondità di 20 cm a suolo per garantire una tenuta ottimale.

7 PGRV200 - profilo colore nero dimensioni (L x l x h) mm 1000 x 200 x 200, peso 19,7 kg

8 PGRV29 - tassello di fissaggio lunghezza 250 mm, Ø 16 mm (necessari 3 pezzi per il fissaggio di PGRV200)



Rallentatori di velocità omologati

Dossi composti da elementi modulari in gomma parzialmente riciclata e legante elastomerico, con inserti rifrangenti in laminato elastoplastico conforme UNI EN 1436 - EN 1790 di colore giallo, conformi al Codice della Strada che ne regola l'utilizzo (art. 42 DPR 16/12/92 n° 495 art. 179 del Regolamento di Esecuzione e di Attuazione del Nuovo Codice della Strada). Collegamento tra i vari moduli: a incastro. Visibilità notturna mediante zebrature gialle e inserti realizzati con laminato elastoplastico rifrangente. Fissaggio mediante tasselli ad espansione DAT6006 mm 10 x 120 tirafondo in acciaio ad alta resistenza 7 x 120 rondella 8 x 24 (da ordinare a parte nelle quantità sotto indicate).

È OBBLIGATORIA L'INSTALLAZIONE DI UN SEGNALE STRADALE DI PERICOLO INDICANTE LA PRESENZA DEL DOSSO, CORREDATO DI PANNELLO ESPLICATIVO E DI UN SEGNALE DI LIMITE MASSIMO DI VELOCITÀ (PAGINA 278). ART. 179 - COMMA 7 - NUOVO CODICE DELLA STRADA.

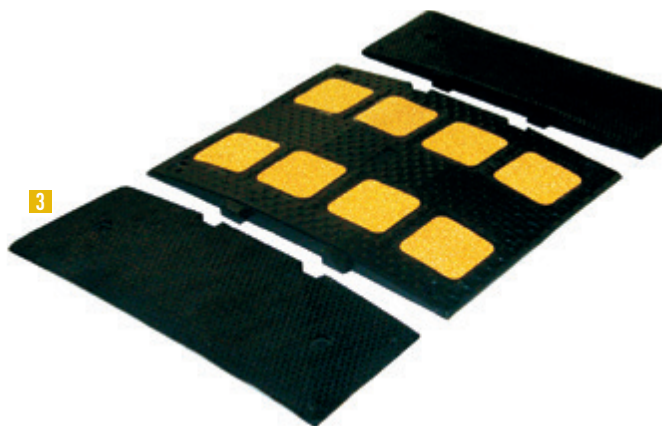
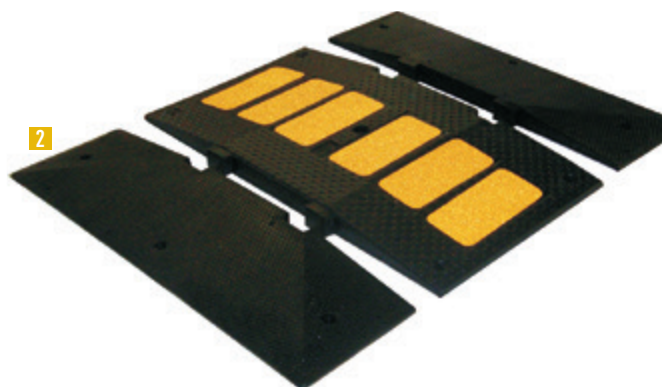
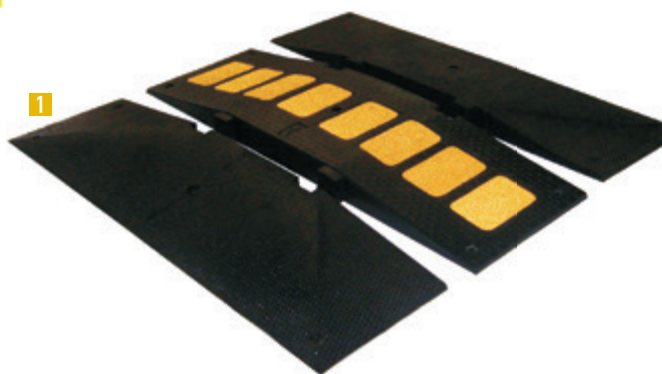

1 RALLENTATORE DI VELOCITÀ

DAT730 - rallentatore di velocità h 7 cm per strade con limite inferiore o pari a 30 km/h, dimensioni 34 x 120 x 7 cm (peso 23 kg). Pezzo unico da 34 cm, ne occorrono 3 pz per realizzare 1 mt.

ELEMENTI TERMINALI

DAT730M - terminale maschio per cordolo h 7 cm, peso 14 kg

DAT730F - terminale femmina per cordolo h 7 cm, peso 14 kg

DAT6006 - tassello di fissaggio 10 x 115 tirafondo in acciaio ad alta resistenza 7 x 120 rondella 8 x 24 (5 pz. per ogni modulo)

2 RALLENTATORE DI VELOCITÀ

DAT540 - rallentatore di velocità h 5 cm per strade con limite inferiore o pari a 40 km/h, dimensioni 50 x 90 x 5 cm (peso 18 kg). Pezzo unico da 50 cm, ne occorrono 2 pz per realizzare 1 mt.

ELEMENTI TERMINALI

DAT540M - terminale maschio per cordolo h 5 cm, peso 7 kg

DAT540F - terminale femmina per cordolo h 5 cm, peso 7 kg

DAT6006 - tassello di fissaggio 10 x 115 tirafondo in acciaio ad alta resistenza 7 x 120 rondella 8 x 24 (5 pz. per ogni modulo centrale e 3 per ogni terminale)

3 RALLENTATORE DI VELOCITÀ

DAT350 - rallentatore di velocità h 3 cm per strade con limite inferiore o pari a 50 km/h, dimensioni 48 x 60 x 3 cm (peso 8 kg). Pezzo unico da 50 cm, ne occorrono 2 pz per realizzare 1 mt.

ELEMENTI TERMINALI

DAT350M - terminale maschio per cordolo h 3 cm, peso 4 kg

DAT350F - terminale femmina per cordolo h 3 cm, peso 4 kg

DAT6006 - tassello di fissaggio 10 x 115 tirafondo in acciaio ad alta resistenza 7 x 120 rondella 8 x 24 (4 pz. per ogni modulo centrale e 2 per ogni terminale)

4 COPERTURA DI PROTEZIONE

Ideale per strade provvisorie, strade provvisorie, percorsi pedonali, aree di lavoro per impianti e macchinari o aree di stoccaggio. Per impieghi di media intensità. Materiale: 100% polietilene riciclato ad alta densità (HDPE). Capacità di carico 120 tonnellate/m².

PDCJ503 - copertura mm 1200 x 2410 x 12 mm, peso 35 kg

PDCJ507 - copertura mm 600 x 2410 x 12 mm, peso 17,5 kg



LEGGERA (35 KG) MA MOLTO RESISTENTE (120 TON./M²)!



RAMPE PASSACAVI



1

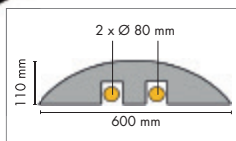

2

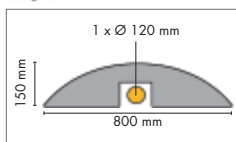

PASSACAVI PER UTILIZZI GRAVOSI

Realizzati in gomma 100% di colore nero con inserti bianchi riflettenti e 4 occhi di gatto. Fornito in due modelli in dimensioni diverse con un foro per il passaggio dei cavi oppure con 2 fori. Si installano al suolo mediante semplice posa oppure con sistemi di fissaggio a richiesta forniti a parte:

- sistema di fissaggio per asfalto (PGRV25): 4 pezzi per ogni modulo
- sistema di fissaggio per cemento (PGRV26): 4 pezzi per ogni modulo

Testati per portata: 36 t.

1 PGRV22 - passacavi mm 600 x 500 x 110 h, con 2 fori per passaggio cavi. Peso 22 kg

2 PGRV23 - passacavi mm 800 x 500 x 150 h, con 1 foro per passaggio cavi. Peso 42 kg



3

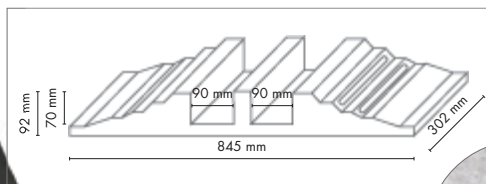

4

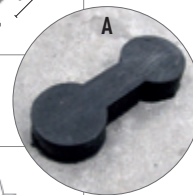
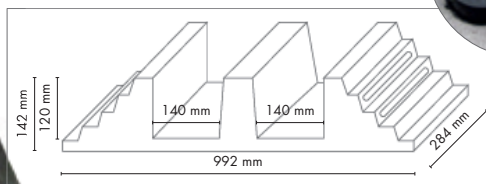

RAMPE PASSACAVI

In gomma ad alta resistenza, durezza 65 Shore A. Dotate di profonde scanalature consentono il passaggio di cavi e tubi presenti nei cantieri temporanei e durante i lavori di manutenzione. Sono assemblabili fra di loro tramite un comodo sistema ad incastro (A) fornito a corredo. Testati per portata: 70 q (per singolo assale).

3 PGR080 - rampa passacavi, dimensioni: mm 845 x 302 x 92 h, kg 12,8, Ø passaggio cavo max mm 85

4 PGR110 - rampa passacavi, dimensioni: mm 992 x 284 x 142 h, kg 21,3, Ø passaggio cavo max mm 135

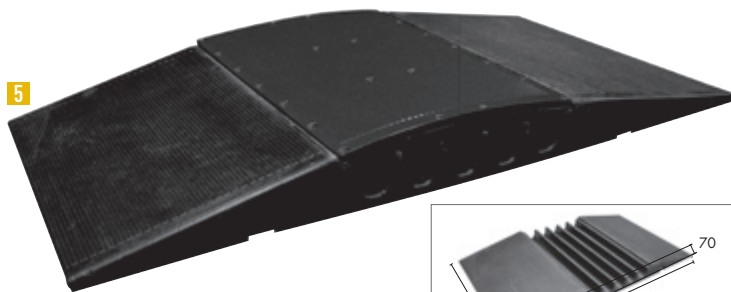

5

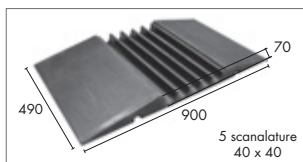

5 RAMPE PASSACAVI

In gomma elastica ad alta resistenza, (60/70 Shore). 5 scanalature mm 40 x 40 per il passaggio dei cavi e con protezione superiore avvitata. Buona resistenza all'abrasione, scarsa resistenza alle alte velocità, utilizzabile in ambienti con temperature da -20°C a +50°C. Per passaggio cavi nei cantieri o durante lavori di ristrutturazione con necessità di proteggere i cavi stessi. Fissaggio al suolo per semplice posa. Peso: kg 17. Portata: q 35 (per singolo assale). Velocità max di passaggio 4 km/h.

PGR090N - rampa passacavi mm 900 x 490 x 70 h, colore nero

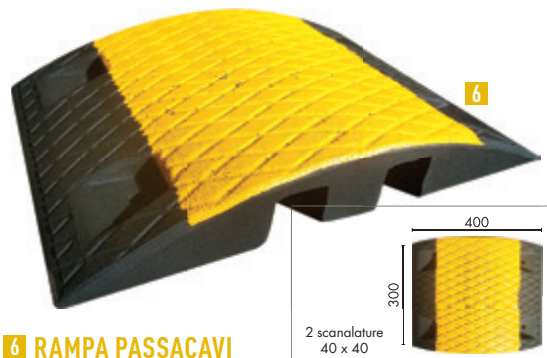

6

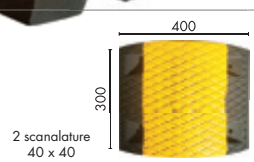

6 RAMPA PASSACAVI

Realizzata in gomma ad alta resistenza in diverse esecuzioni. Utile in presenza di cavi volanti durante lavori di ristrutturazione di ambienti industriali. Si fissa al suolo tramite tasselli (non in dotazione - 4 fori Ø mm 8). Dimensioni: mm 400 x 300 x 60 h. Peso 4,8 kg, passaggio cavo mm 40 x cavo Ø max 30 mm. Testati per portata: 35 q (per singolo assale).

PGR30GN - elemento in gomma grezza colore giallo/nero



1 RAMPA PASSACAVI A 2 POSTI

In gomma vulcanizzata, può alloggiare fino a 2 cavi Ø 30 mm. Ideale per usi temporanei, semplici da installare e stoccare. Facilmente trasportabili grazie alla comoda maniglia. Bloccaggio a incastro, non necessita di sistemi di fissaggio. A richiesta fornibili elementi ad angolo. Peso kg 7.

PGR A02 - rampa passacavi, mm 980 x 240 x altezza 45

2 RAMPA PASSACAVI A 5 POSTI

Può alloggiare fino a 5 cavi. Ideali per usi temporanei come fiere o concerti. Facili da maneggiare, installare e stoccare. Dimensioni alloggiamenti 5 fori Ø 34 mm. Grazie al suo peso non necessita di sistemi di fissaggio. Portata: 15 t.

2 PGRV47 - rampa passacavi fino a 5 alloggiamenti. Dimensioni: lunghezza 910 mm x 500 mm x altezza 48 mm. Peso kg 16,5

3 PGRV47A - angolo 30°. Dimensioni: lunghezza 200 mm x 500 mm x altezza 48 mm. Peso kg 4

3 RAMPA PASSACAVI A 3 POSTI

Rampa passacavi in gomma, può alloggiare fino a 3 cavi. Ideali per usi temporanei, semplici da installare e stoccare, facilmente trasportabili grazie alla comoda maniglia (A). Dimensioni alloggiamenti Ø 50 mm. Grazie al suo peso non necessita di sistemi di fissaggio. Portata: 20 t.

4 PGRV49 - angolo 30°. Dimensioni: lunghezza 600 mm x 500 mm x altezza 70 mm. Peso kg 4,60

5 PGRV48 - rampa passacavi fino a 3 alloggiamenti. Dimensioni: lunghezza 910 mm x 500 mm x altezza 70 mm. Peso kg 16,8



4 RAMPA PASSACAVI IN CAUCCIÙ

Realizzata in caucciù, ideale su strada o magazzini. È possibile collegare i vari elementi tramite due barre incluse (B). Uso interno/esterno. Maggiore visibilità grazie alle 2 bande gialle riflettenti. Fornibile elemento angolare a 45° che si raccorda alla rampa tramite elementi di giunzione in caucciù. Un foro per cavi Ø 60 mm. Portata: 36 t. Per un'applicazione prolungata si consiglia l'utilizzo della colla.

6 PGRV240 - rampa passacavi lunghezza 1000 mm x 240 mm x altezza 72 mm, peso 8,10 kg

PGRV240A - elemento angolare lunghezza mm 240 x 240 x altezza 72 mm, peso 1 kg

7 PGRV17 - colla ml 300, resa 2 metri lineari

8 PASSACAVI PER UFFICI

Passacavi flessibile in PVC colore grigio con biadesivo. Si taglia facilmente con cutter per adattarlo alla lunghezza necessaria. Classe antifuoco 94V-O. Fornito in rotoli da 3 m.

PGRV653 - rotolo da 3m di passacavi morbido in PVC con biadesivo

9 RAMPA PASSACAVI IN ROTOLO

Rotolo di rampa passacavi in gomma, per uno o più cavi. In rotoli da m 10 (1 foro Ø 20 mm) oppure da m 4 (1 foro Ø mm 40). Facile da maneggiare, installare e stoccare. Possibilità di tagliare a lunghezza desiderata. Per un'applicazione prolungata si consiglia l'utilizzo della colla.

PGRV15 - rampa passacavi, lunghezza m 10 x 100 mm x altezza 30 mm (1 foro da Ø 20 mm). Peso kg 15,5

PGRV16 - rampa passacavi, lunghezza m 4 x 170 mm x altezza 50 mm (1 foro da Ø 40 mm). Peso kg 17,3

PGRV17 - colla ml 300, resa 2 metri lineari



PARACOLPI, ANGOLARI E BARRE DI DELIMITAZIONE

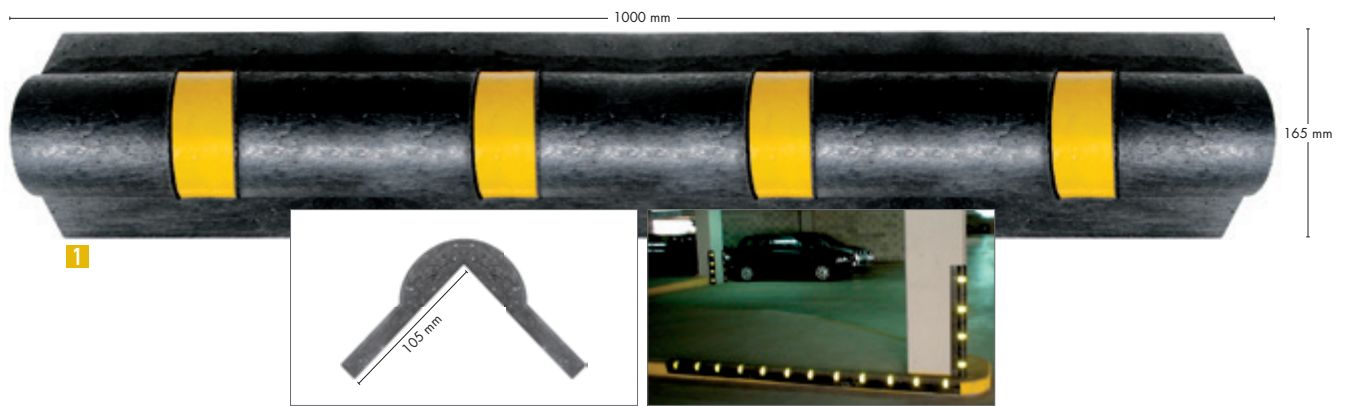

ANGOLARE E PARACOLPI IN PVC RICICLATO E RICICLABILE

- 1 **PCL100** - angolare lunghezza mm 1000, larghezza angolo interno mm 105 + 105, spessore mm 14, peso kg 4,5, con 4 inserti gialli rifrangenti. Applicabile mediante tasselli da mm 8 (angolare fornito senza fori) o con collante tipo silicone (entrambi non forniti)
- 2 **PCL101** - paracolpi lunghezza mm 1000, larghezza mm 180, spessore mm 14, peso kg 5,5, con 4 inserti gialli rifrangenti. Applicabile mediante tasselli da mm 8 (paracolpi fornito già forato) o con collante tipo silicone (entrambi non forniti)

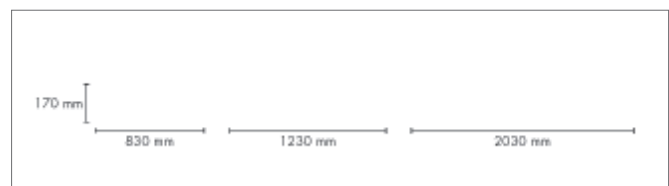

BARRE DELIMITAZIONE AREE E PARCHEGGI

Per la protezione di aree dall'accesso di veicoli, per la separazione di vie di transito e per parcheggi. In acciaio mm 3, colore giallo/nero alternati per un'ottima visibilità. Ø barra mm 75, tre lunghezze fornibili (mm 830, 1230 e 2030). Sistema di fissaggio fornito separatamente. Due piastre di base per ancoraggio al suolo.

- 4 **PGRV80** - barra delimitazione aree e parcheggi Ø mm 75. Lunghezza cm 83, peso kg 6,7
- 5 **PGRV81** - barra delimitazione aree e parcheggi Ø mm 75. Lunghezza cm 123, peso kg 8,4
- 6 **PGRV83** - barra delimitazione aree e parcheggi Ø mm 75. Lunghezza cm 203, peso kg 14
- 7 **PGRV84** - elemento di giunzione angolare 90° per barre in acciaio di colore giallo Ø mm 75. Dimensioni 185 x 185 mm, peso kg 5
- PGRV26** - sistema di fissaggio per cemento. Necessari 4 pezzi per PGRV80 e PGRV81, 6 pezzi per PGRV83



FERMARUOTA CON INSERTI RIFRANGENTI

Realizzato in polipropilene durevole (PPC) con strisce gialle riflettenti. Adatto per l'uso in strade urbane e interurbane, piste ciclabili e per delimitare aree di parcheggio. Indeformabile e resistente agli urti. Fissaggio con viti e tasselli (non inclusi). Temperatura d'uso ottimale: -20°C/+60°C.

- 1 **PGRL190** - fermaruota, dimensioni 1900 x 150 x 100 mm (l x l x h), peso 6,7 kg
- 2 **PGRL060** - fermaruota, dimensioni 600 x 150 x 100 mm (l x l x h), peso 2,0 kg



PROFILI COLORATI PER DELIMITAZIONE AREE

Profili di protezione colorati in polietilene e fibra ideali per delimitare aree e/o posti auto fornendo con il colore indicazione sull'utilizzo (ad esempio blu: area a pagamento). Resistenti ad oli e acidi, ideali in ambienti con temperature da -40°C a +60°C. Fissaggio con viti e tasselli (non inclusi). Disponibili in 3 colori: blu, giallo e bianco.

- 3 **PGRV183W** - profilo battiruota colore bianco, dimensioni (l x l x h) mm 1830 x 130 x 95, peso 14,4 kg
- 4 **PGRV183B** - profilo battiruota colore blu, dimensioni (l x l x h) mm 1830 x 130 x 95, peso 14,4 kg
- 5 **PGRV183Y** - profilo battiruota colore giallo, dimensioni (l x l x h) mm 1830 x 130 x 95, peso 14,4 kg



PROFILI PER DELIMITAZIONE AREE

Ideali per proteggere aree e delimitare il traffico in aree private. In gomma vulcanizzata, resistenti alle variazioni di temperatura, ai raggi UV, agli oli e all'umidità. Colore nero/giallo, ottima visibilità grazie alle strisce rifrangenti gialle. Due canaline passacavo integrate per cavi fino a Ø 20 mm (A). Comode maniglie laterali per un facile trasporto. Fissaggio con viti e tasselli (non inclusi).

- 2 **PGRA30** - profilo 550 x 150 x 100 mm (l x l x h), peso 3,2 kg
- 3 **PGRA18** - profilo 900 x 150 x 100 mm (l x l x h), peso 5,4 kg
- 4 **PGRA31** - profilo 1220 x 150 x 100 mm (l x l x h), peso 9 kg
- 5 **PGRA19** - profilo 1830 x 150 x 100 mm (l x l x h), peso 13 kg



BATTIRUOTA IN GOMMA RICICLATA

Elementi modulari usati per delimitare aree di parcheggio e posti auto. **Fornibile a richiesta con inserto in pellicola rifrangente.** Fissaggio con viti e tasselli (non inclusi). Dimensioni: mm 700 x 160 x 100 h. Peso kg 7.

- 6 **PCL70Y** - battiruota in gomma gialla
- 7 **PGR70N** - battiruota in gomma grezza nero
- PCLT** - tassello di fissaggio mm 10 x 100 + vite a rondella



PARACOLPI PER BANCHINE, RAMPE E PASSERELLA PEDONALE

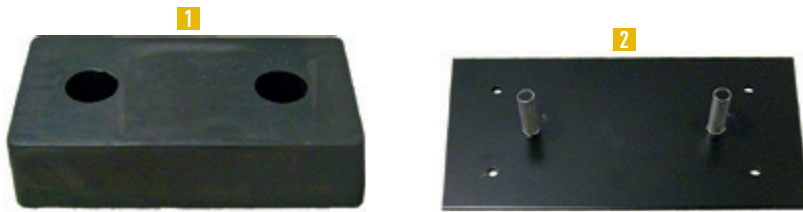

PROTEGGONO LE BANCHINE DA URTI ACCIDENTALI DURANTE LA MOVIMENTAZIONE DELLE MERCI

PARACOLPI PER BANCHINE E RIBALTE

Paracolpi in robusta gomma per proteggere le banchine di carico, proteggono da eventuali urti durante le operazioni di carico e scarico merci. Resistenti a temperature da -40°C a +80°C. Il paracolpi può essere fissato su un supporto in acciaio opzionale. Sistemi di fissaggio non inclusi nella fornitura.

- 1 **PGRV300** - paracolpi, dimensioni (l x l x h) mm 300 x 230 x 105, peso kg 9
- PGRV302** - paracolpi, dimensioni (l x l x h) mm 500 x 250 x 105, peso kg 16
- 2 **PGRV301P** - piattina opzionale in acciaio per fissaggio, dimensioni (l x l x h) mm 320 x 270 x 10, Ø 12 cm, peso kg 7,3
- PGRV303P** - piattina opzionale in acciaio per fissaggio, dimensioni (l x l x h) mm 500 x 250 x 10, Ø 12 cm, peso kg 7,3



ALTRE TIPOLOGIE DI PARACOLPI A PAGINA 216.



PARACOLPI PER BANCHINE E RIBALTE

Protezioni per banchine di carico in gomma rigida. Proteggono dagli urti dei mezzi e dalle manovre durante operazioni di carico e scarico. Da fissare con tasselli (non forniti), foro Ø 16 mm. Temperatura di utilizzo -40°C + 80°C.

- 3 **PGRV101** - paracolpi per banchine lunghezza 1000 x 100 x altezza 100 mm (3 fori), peso 8,45 kg
- 4 **PGRV151** - paracolpi per banchine lunghezza 1000 x 150 x altezza 150 mm (2 fori), peso 20,3 kg
- 5 **PGRV29** - tassello di fissaggio per paracolpi, lunghezza 250 mm, Ø 16 mm



6 RAMPA DI ACCESSO

Ideale per chi utilizza carrelli e deve oltrepassare piccole barriere tipo scalini o marciapiedi da 74 a 150 mm h. Perfetto anche per sedie a rotelle. Superficie antiscivolo e lati rialzati, colore standard giallo. In polietilene ad alta densità, può essere riciclato. Portata massima raccomandata: kg 350.

BAR0806 - rampa gialla, dimensioni (L x l x h) mm 1256 x 750 x 75; peso kg 6



RAMPE MOBILI IN ALLUMINIO

Rampa di accesso pieghevole in alluminio. Progettata per il passaggio di sedie a rotelle e scooter su marciapiede o per accesso a un veicolo. Resistente, sicura, leggera e richiudibile per rendere agevole il trasporto. Quando necessario, la rampa si separa rimuovendo gli assi delle 2 cerniere. Regolazione automatica della piastra di transizione inferiore. Carico massimo 300 kg.

- 8 **PASV125** - rampa mobile, dimensioni aperta (l x l x h) 1220 x 710 x 50 mm, dimensioni chiusa (l x l x h) 1220 x 350 x 70 mm, peso 9,2 kg
- 9 **PASV178** - rampa mobile dimensioni aperta (l x l x h) 1830 x 710 x 50 mm, dimensioni chiusa (l x l x h) 1830 x 360 x 70 mm, peso 13,8 kg

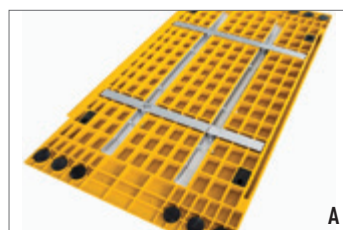

7 PASSERELLA PEDONALE

Passerella completa di due scivoli e parapetti, ideale per utilizzo nei cantieri. Colore giallo RAL 1023. Fondo composto da barre di rinforzo in acciaio per una portata massima di 1000 kg (A).

PASV800 - passerella da cantiere, dimensioni (l x l x h) mm 1400 x 800 x 50, peso 26,5 kg

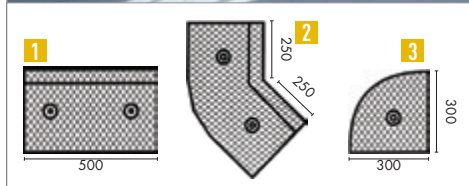

CORDOLI IN GOMMA RICICLATA

Per realizzare isole rotatorie, cordonature perimetrali e corsie d'incanalamento. Alternabili cordoli in gomma grezza nera con cordoli colorati rifrangenti. Forniti con due robusti tasselli in plastica dotati di tirafondi in acciaio e rondelle. Predisposizione inserimento marker stradali (forniti separatamente).

Colori: **W** bianco **R** rosso **Y** giallo

- 1 FIM5025N** - cordolo rettilineo grigio granito in gomma, h 150 x 300 x 500 mm, peso kg 14
FIM5027 - come sopra, termoplastico rifrangente (specificare colore)
- 2 FIM5028N** - cordolo angolo 45° grigio granito in gomma, h 150 x 300 x 250 + 250 mm, peso kg 22
FIM5030 - come sopra, termoplastico rifrangente (specificare colore)
- 3 FIM5034N** - cordolo angolo 90° grigio granito in gomma, h 150 x 300 x 300 mm, peso kg 5
FIM5035 - come sopra, termoplastico rifrangente (specificare colore)



SEPARATORE PER PISTE CICLABILI D.M. 577

Cordolo in gomma grigia riciclata, studiato per delimitare piste ciclabili, economico e facilmente installabile. Ogni cordolo è dotato di 4 tasselli di fissaggio mm 14 x 120 e relativi tappi copri foro e alloggia 16 cubetti in calcestruzzo disponibili nei colori bianco, rosso, antracite e ocra (specificare in fase d'ordine).

Colori: **W** bianco **R** rosso **S** grigio antracite **Y** ocra

- 4 FIB1100** - cordolo terminale, dimensioni mm 1000 x 500 x 130 h, peso kg 64
- 5 FIB1000** - cordolo centrale, dimensioni mm 1000 x 500 x 130 h, peso kg 63 (specificare colore)

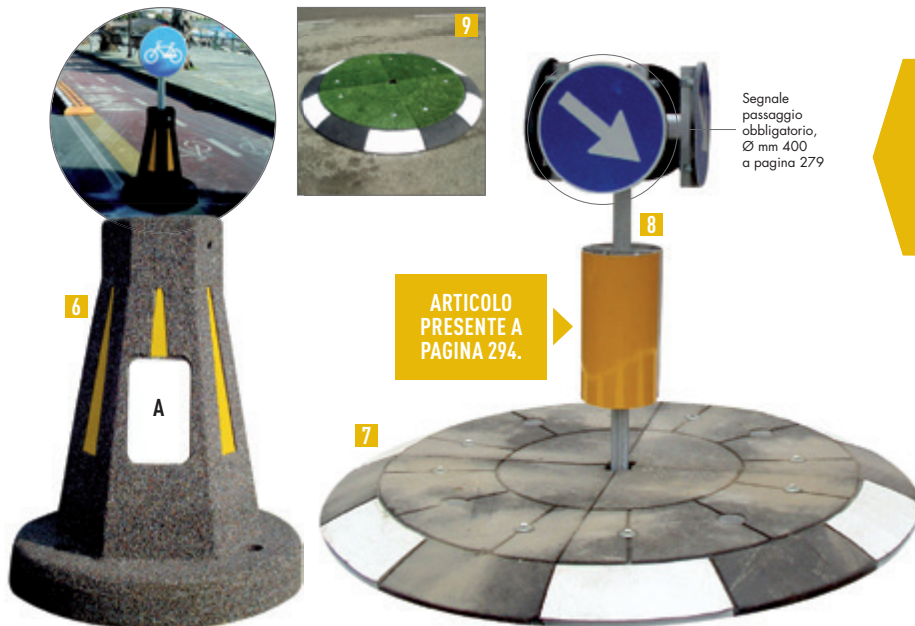

6 DISSUASORE DI SOSTA IN GOMMA RICICLATA

Non danneggia le autovetture. Fornito con foro per palo da Ø mm 60. A richiesta: 2 golfari in acciaio zincato; inserti rifrangenti; personalizzazione (A); 3 fori per il fissaggio a terra; 3 tasselli di fissaggio al suolo.

- FID6020** - dissuasore mm 600 x 750, peso kg 80
- FID6020R** - kit 6 inserti rifrangenti di colore giallo, dimensioni mm 60 x 340
- FID6020G** - coppia di golfari
- FID6020T** - tre tasselli (3 D 16 x 140 completi di tappo)
- FID6020P** - personalizzazione stampa in quadricromia digitale UV protetta, formato mm 120 x 200

ROTONDA IN GOMMA RICICLATA

Formata da 4 spicchi, dotata di tasselli di fissaggio e otto marker stradali. Corona esterna verniciata alternativamente nero/bianco. Possibilità di alloggiare al centro della rotonda una base idonea a supportare un palo segnaletico Ø mm 60. A richiesta, fornibile con corona esterna nero/giallo.

- 7 FIR5032** - rotonda, dimensioni: Ø mt 2, spessore mm 100. Peso kg 280
- 8 FIR6011S** - sostegno metallico a 4 vie, Ø mm 60
- 9 FIR5033** - rotonda come sopra, ma con parte centrale ricoperta di finta erba



SPECCHI DI SORVEGLIANZA

Efficace strumento di prevenzione, sicurezza e sorveglianza di magazzini, depositi, officine ecc. Per interni, in materiale acrilico, robusto e di elevata qualità ottica. Indeformabili e predisposti per l'attacco a soffitto (fori sui bordi per tutti i modelli). Grazie al modesto peso e all'ampio campo visivo sono la soluzione ideale per eliminare zone nascoste o con scarsa visibilità.

- 1 SP36** - semisfera visibilità 360° - Ø mm 600, distanza di visibilità: circa m 8 dallo specchio
- SP38** - semisfera visibilità 360° - Ø mm 800, distanza di visibilità: circa m 16 dallo specchio
- 2 SP180** - quarto di sfera visibilità 180° - Ø mm 600, intersezione a "T" (visibilità: 3 vie)
- 3 SP90** - angolare 90° - Ø mm 600, intersezione a "L" (visibilità: 2 vie), distanza di visibilità: circa m 8 dallo specchio

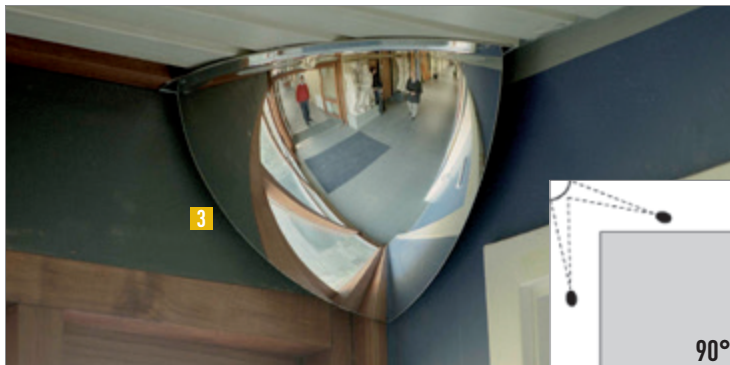
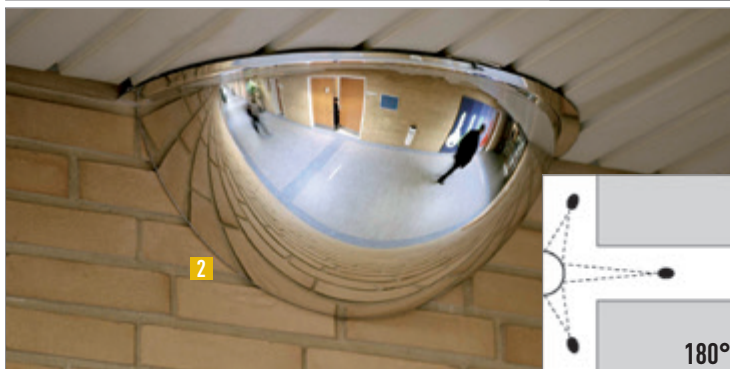

4 CUPOLA DI SORVEGLIANZA LINEA ECONOMY

Cupola di sorveglianza in polimetilmetacrilato. Trattamento della superficie esterna: acrilico alluminizzato. Parte specchiata protetta da pellicola adesiva trasparente.

- SP002** - cupola di sorveglianza Ø cm 60
- SP004** - cupola di sorveglianza Ø cm 80
- SP005** - cupola di sorveglianza Ø cm 100

Specchi industriali



SPECCHI INDUSTRIALI CON CORNICE GIALLO/NERA

Specchi industriali con cornice giallo/nera in materiale plastico, indicati per rendere visibili angoli ciechi o pericolosi nelle aree di produzione o nei magazzini. La versione rotonda è dotata di parte specchiante convessa in polimetilmetacrilato e posteriore in polistirolo. La versione rettangolare è resistente agli urti e agli agenti atmosferici, trattamento superficie esterna in acrilico alluminizzato. Installabili su pali Ø 60 mm. Possibilità di installazione su palo Ø 48 mm mediante apposita staffa piatta.

- 5 SP044** - specchio 60 x 40 cm, peso 4 kg
- SP043** - specchio 80 x 60 cm, peso 5,5 kg
- SP042** - specchio 100 x 80 cm, peso 8 kg
- 6 SP045** - specchio Ø 60 cm, peso 3,7 kg
- SP050** - specchio Ø 80 cm, peso 6 kg
- SP051** - specchio Ø 100 cm, peso 10 kg

Specchi per interni Vista Economic



Parte riflettente acrilica rifinita lungo il bordo, guarnizione in PVC nero e attacco in plastica con snodo regolabile che permette di ampliare il campo visivo della zona da sorvegliare. Estremamente leggero, ideale in ambienti interni come negozi, supermercati, portinerie e in tutti i luoghi che necessitano di una sicurezza discreta.

7 SPECCHI CON ATTACCO RIGIDO

- SP40** - Ø cm 40, lunghezza attacco cm 25, peso kg 0,7
- SP50** - Ø cm 50, lunghezza attacco cm 25, peso kg 1
- SP60** - Ø cm 60, lunghezza attacco cm 30, peso kg 1,5
- SP70** - Ø cm 70, lunghezza attacco cm 35, peso kg 1,9

8 SPECCHI CON ATTACCO FLESSIBILE

- SP41** - Ø cm 40, lunghezza attacco cm 20, peso kg 0,9
- SP51** - Ø cm 50, lunghezza attacco cm 30, peso kg 1,3
- SP61** - Ø cm 60, lunghezza attacco cm 30, peso kg 1,8
- SP71** - Ø cm 70, lunghezza attacco cm 40, peso kg 2,3



1



1 SPECCHI PARABOLICI INFRANGIBILI

Specchi parabolici in metacrilato, con montatura e visiera in polipropilene colore rosso, guarnizioni in PVC nero. Completati di attacco per applicazione a palo Ø 60 mm o alla staffa a muro, orientabili in tutti i sensi. Visibilità a 90°. **Pali di sostegno a pagina 293.**

- SP203** - specchio parabolico Ø 30 cm
- SP204** - specchio parabolico Ø 40 cm
- SP205** - specchio parabolico Ø 50 cm
- SP206** - specchio parabolico Ø 60 cm
- SP207** - specchio parabolico Ø 70 cm
- SP208** - specchio parabolico Ø 80 cm
- SP209** - specchio parabolico Ø 90 cm

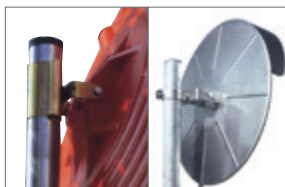

2

ECCELLENTE VISIBILITÀ IN TRE DIREZIONI!

2 SPECCHIO STRADALE "T" PANORAMICO

Specchio grandangolo in materiale acrilico antiurto, offre visibilità in tre direzioni (intersezione a "T"). Sostituisce due specchi stradali convenzionali, chi guida è in grado di vedere nello specchio sia a destra sia a sinistra. Fornito con collare e adattatore per palo da mm 50.

SP750 - specchio stradale "T" Panoramic, dimensioni: mm 785 x 400 x 160

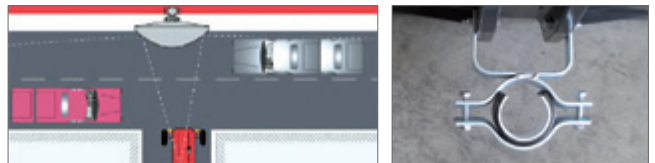

3

3 SPECCHI STRADALI RETTANGOLARI

Con cornice bianco/rossa in materiale plastico ad alta resistenza agli urti e agli agenti atmosferici; installabili su pali Ø 60 mm. Possibilità di installazione su palo Ø 48 mm mediante apposita staffa piatta.

- SP64** - specchio 60 x 40 cm, peso 4 kg
- SP68** - specchio 80 x 60 cm, peso 5,5 kg
- SP810** - specchio 100 x 80 cm, peso 8 kg



4

4 SPECCHI RETTANGOLARI INFRANGIBILI

Specchi rettangolari infrangibili con montatura in plastica e parte ottica in metacrilato specchiato. Attacco per applicazione a palo Ø 60 mm o alla staffa a muro, orientabili in tutti i sensi. Visibilità a 90°. **Pali di sostegno a pagina 293.**

- SP264** - specchio rettangolare 60 x 40 cm
- SP286** - specchio rettangolare 80 x 60 cm

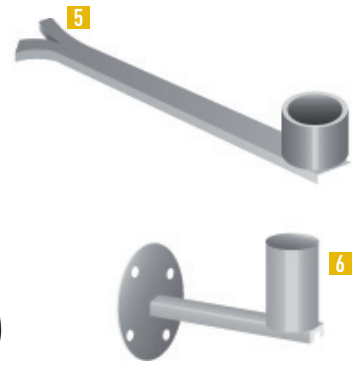

5

6

STAFFE A MURO

- 5 SP10** - staffa per specchi stradali in ferro zincato da murare. Tubo Ø mm 60, lunghezza totale cm 50
- 6 SP11** - staffa per specchi stradali in ferro zincato, fissaggio a tasselli (non forniti). Tubo Ø mm 60, lunghezza totale cm 25
- SP11V** - come SP11 ma in ferro verniciato



7

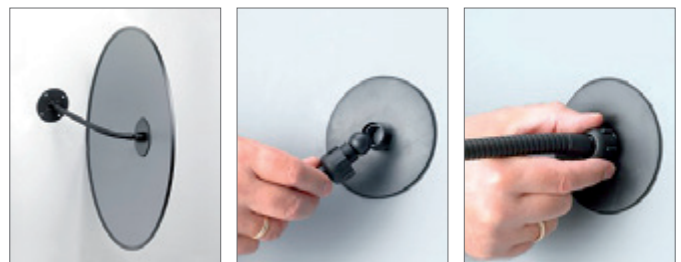

7 SPECCHIO TRIANGOLARE

Eccellente qualità ottica. Ideale per la prevenzione, sicurezza e sorveglianza in magazzini, depositi, negozi, officine ecc. In robusto e resistente materiale acrilico. Cornice bianca. Facile da installare e orientare. Fornito con sistema di fissaggio a muro (viti incluse).

SP333 - specchio triangolare, dimensioni: mm 333 x 333 x 380



MANICHE A VENTO E BARRETTE LUMINOSE

Maniche a vento

La manica a vento è un dispositivo che consente di dare informazioni molto precise sulla forza e la direzione del vento. Progettata per essere montata sui pali, viene realizzata con tessuti tecnici ed è caratterizzata dall'alternanza di colori normalizzati: 3 bande rosse e 2 bande bianche.

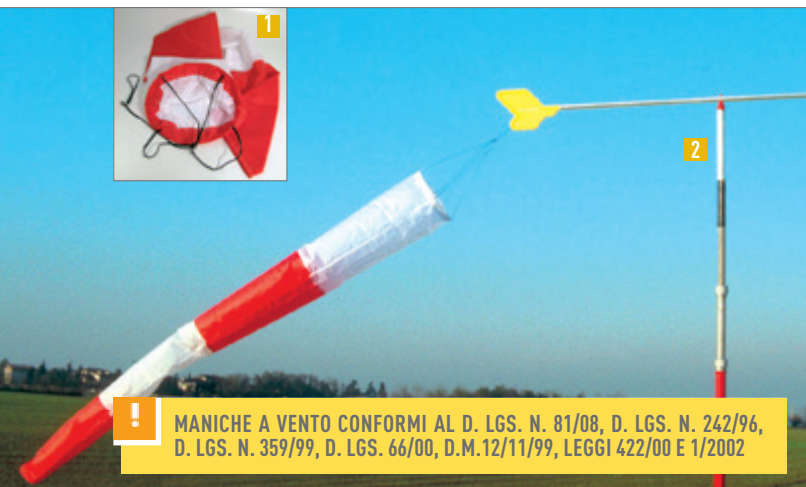

MANICHE A VENTO CONFORMI AL D. LGS. N. 81/08, D. LGS. N. 242/96, D. LGS. N. 359/99, D. LGS. 66/00, D.M.12/11/99, LEGGI 422/00 E 1/2002



MANICHE A VENTO CONFORMI ALLA NORMATIVA AERONAUTICA (ICAO).

MANICHE A VENTO IN POLIESTERE BIANCO/ROSSO

Modello disponibile in 3 tessuti diversi: **Light, Light HT, Medium**. La scelta del tessuto deve essere fatta in base alle rilevazioni del vento (es. per venti molto leggeri si devono adottare tessuti leggeri). I pesi indicati in tabella si riferiscono al prodotto finito (cono tessuto, funicelle, cerchio in fibra di vetro, palo escluso).

DIMENSIONI MANICHE A VENTO SINGOLE (cm)

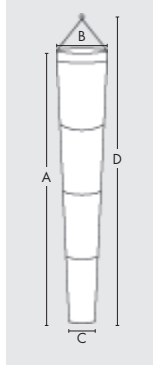

1 CODICE	TESSUTO	A	B	C	D	PESO
MAVE150	Light	130	20	10	150	82 gr
MAVE160 *	Light	160	45	20	200	183 gr
MAVE200	Light	200	28	14	220	140 gr
MAVE150HT	Light HT	130	20	10	150	110 gr
MAVE160HT *	Light HT	160	45	20	200	294 gr
MAVE200HT	Light HT	200	28	14	220	209 gr
MAVE150BM	Medium	130	20	10	150	160 gr
MAVE160BM *	Medium	160	45	20	200	425 gr
MAVE200BM	Medium	200	28	14	220	307 gr

* modello ENI

2 MAVE150K - kit composto da: manica a vento mt 1,50, indicatore di direzione, paletto in alluminio supporto da mt 0,5 (da applicare a palo esistente tramite fascette non fornite), istruzioni per il montaggio

3 MANICHE A VENTO IN TESSUTO POLIESTERE/ACRILICO

Modello LONG TIME in tessuto poliestere/acrilico, tinto in pasta 100%, teflonato in filo, totalmente idrorepellente in colore bianco e rosso, completa di collare di rinforzo, **conforme alla normativa aeronautica (ICAO)** per eliporti ed elisuperfici. Lavorazione: tessuto tagliato per mezzo di banco di taglio laser cauterizzante, cucitura ribattitura all'inglese con macchine a due aghi paralleli, punto annodato.

MAVEF160 - manica a vento modello ACR-BR-160 da m 1,6, lunghezza cm 160, Ø cm 45

MAVEF260 - manica a vento modello ACR-BR-260 da m 3, lunghezza cm 260, Ø cm 60

MAVEF360 - manica a vento modello ACR-BR-360 da m 4, lunghezza cm 360, Ø cm 90

MAVEFP4 - palo e supporto rotante in acciaio inox lunghezza m 4 modello ELI-H4

MAVEFP4A - palo come sopra lunghezza m 4 con asta abbattibile inox modello ELI-H4-A

MAVEFP6 - palo e supporto rotante in acciaio inox lunghezza m 6 modello ELI-H6

MAVEFP6A - palo come sopra lunghezza m 6 con asta abbattibile inox modello ELI-H6-A

MAVEFC5 - cerchio reggimanica da cm 45 modello CER45X

MAVEFC6 - cerchio reggimanica da cm 60 modello CER60X

MAVEFC9 - cerchio reggimanica da cm 90 modello CER90X

(i cerchi sono disponibili a richiesta in tutte le misure proposte, nella versione con cuscinetto assiale o ControCono)

Barrette luminose Snaplight®



4 BARRETTE LUMINOSE SNAPLIGHT®

TNL18 - **barretta luminosa lunghezza mm 150 x Ø 18**, durata 12 ore (blu 8 ore). Attivabile mediante torsione, spezzando il bastoncino e agitandolo. Con gancio e base piana, può essere appesa o appoggiata in posizione verticale. Minimo ordinabile 10 pezzi/multipli.

Colori: **R** rosso **Y** giallo **B** blu **G** verde

TNL25Y - **barretta luminosa colore giallo, lunghezza mm 250 x Ø 18**, durata 2 ore. Attivabile mediante torsione, spezzando il bastoncino e agitandolo. Con gancio e base piana, può essere appesa o appoggiata in posizione verticale. Minimo ordinabile 10 pezzi/multipli.

TNL40Y - **barretta luminosa colore giallo, lunghezza mm 400 x Ø 19**, durata 12 ore. Attivabile mediante impatto (contro qualsiasi tipo di superficie), due ganci alle estremità per essere appesa o appoggiata in posizione verticale. Minimo ordinabile 5 pezzi/multipli.

SUPPORTI A MURO

Supporti a muro per barrette luminose SnapLight® da 150 mm. Facile riconoscimento in situazioni di emergenza.

5 TNL21BY - supporto con etichetta fotoluminescente. Contenuto: 2 bastoncini luminosi SnapLight® da 15 cm colore giallo (durata 2 ore), istruzioni, accessori di fissaggio e 2 sigilli anti-manomissione

6 TNL20SG - supporto interamente fotoluminescente. Contenuto: 2 bastoncini luminosi SnapLight® da 15 cm colore verde (durata 12 ore). Montaggio a parete con nastro biadesivo o viti (non inclusi nella fornitura)



Bandiere internazionali e personalizzate

Bandiere nazionali, internazionali e personalizzate per la comunicazione esterna istituzionale, commerciale e di arredo ambientale, in grado di soddisfare ogni esigenza aziendale ed espositiva. Prodotti eco compatibili realizzati in materiale certificato e normalizzato a livello europeo per la produzione di bandiere: poliestere nautico al 100%, orlato sui 3 lati, confezionato nel lato dell'attacco con sagola di rinforzo bianca e occhielli, termosaldato (antisfilo) certificato ignifugo, 100% riciclabile e atossico. Le bandiere sono disponibili in due misure: 1000 x 1500 e 1500 x 2250 mm da abbinare rispettivamente ai pennoni di lunghezza 6 e 8 mt, composti da 2 e 3 sezioni per facilitarne il trasporto. Per l'installazione delle bandiere con fissaggio a muro o in verticale, sono forniti aste in alluminio da 2,5 e 3 mt con relativi supporti. Tutti i pennoni sono stati testati e certificati secondo Decreto Ministeriale 2008 in base ai dati forniti su resistenza al vento, trazione e forze, vengono forniti con una base controtubo in alluminio da gettare nel suolo creando una base in cemento.



BANDIERA ITALIA ED EUROPA

- 1 BAE150** - bandiera stampata Europa, dimensioni 1000 x 1500 mm
- BAE225** - bandiera stampata Europa, dimensioni 1500 x 2250 mm
- 2 BAI150** - bandiera cucita Italia, dimensioni 1000 x 1500 mm
- BAI225** - bandiera cucita Italia, dimensioni 1500 x 2250 mm

BANDIERE EUROPEE SENZA LAVORAZIONE

BAPE150 - bandiera cucita mm 1000 x 1500 (abbinare sigla nazione)

BAPE225 - bandiera cucita mm 1500 x 2250 (abbinare sigla nazione)

- F** = Francia
- D** = Germania
- I** = Irlanda
- O** = Paesi Bassi
- R** = Romania



BANDIERE EUROPEE CON LAVORAZIONE

BAPES150 - bandiera stampata mm 1000 x 1500 (abbinare sigla nazione)

BAPES225 - bandiera stampata mm 1500 x 2250 (abbinare sigla nazione)

- | | | | |
|------------------------|--|-------------------------|--|
| E = Spagna | | UK = Inghilterra | |
| P = Portogallo | | DK = Danimarca | |
| C = Croazia | | S = Svezia | |
| A = Albania | | FN = Finlandia | |
| SM = San Marino | | N = Norvegia | |

Spargitori, pala e composto scioglineve



SPARGITORI UNIVERSALI

Adatti per materiali da spargimento corrosivo come ad esempio sale, concime, assorbente in polvere granulati. Permette un notevole risparmio di tempo dosando la quantità esatta di materiale. Modelli per superfici medie.

- 6 CE642** - raggio di spargimento in m: da 1 a 4 m, tramoggia in materiale plastico giallo, staffa in acciaio, ruote in gomma gonfiabili per l'inverno, ingranaggio robusto, regolatore di spargimento, impugnatura regolabile. Capacità tramoggia 19 kg. Peso kg 9
- 7 CE643** - come modello precedente, capacità tramoggia 32 kg. Peso kg 9,5

8 PALA IN POLIPROPILENE ANTI CORROSIONE

Pala in polipropilene altezza 105 cm. Estremamente leggera e resistente, materiale stabilizzato UV. Ideale per operare con sostanze aggressive come sale.

CE7967 - pala in polipropilene anti corrosione, cm 35 x 26 x 8, peso kg 1,4

9 SALE SCIOLINEVE

Indicato per prevenire la formazione di ghiaccio e di strati nevosi, oppure per scioglierli su strade, ingressi, parcheggi. Con antiagglomerante.

CEA25 - sale scioglineve, sacco da 25 kg



10 SCIOLINEVE RAPIDO

Granulare esotermico per lo scioglimento rapido di ghiaccio e neve fino a temperature di -50°C. Usato preventivamente evita la formazione del ghiaccio anche in presenza di basse temperature. Consente un dosaggio da 5 a 10 volte inferiore rispetto ai comuni prodotti scioglineve (sale) agendo fino a 8 volte più velocemente. Bassa aggressività per un impiego sicuro su asfalti normali, drenanti e su cemento.

CEG05 - scioglineve rapido, secchio da 5 kg

CEG10 - scioglineve rapido, secchio da 10 kg

CEG25 - scioglineve rapido, sacco da 25 kg

A RICHIESTA REALIZZIAMO BANDIERE PERSONALIZZATE SENZA VINCOLI DI QUANTITÀ, DIMENSIONI E NUMERO COLORI. È NECESSARIO FORNIRE FILE VETTORIALE E COLORE PANTONE DI RIFERIMENTO.



3



ASTE E SUPPORTI

3 AST25 - asta altezza 250 cm, Ø 32 mm completa di corda, carrucola e pomolo

AST30 - asta altezza 300 cm, Ø 32 mm completa di corda, carrucola e pomolo

PEN6 - pennone in alluminio anodizzato completo di corda, galloccia e pomello, lunghezza 6 mt, Ø 70/50 mm, peso 7,2 kg

PEN8 - pennone in alluminio anodizzato completo di corda, galloccia e pomello, lunghezza 8 mt, Ø 90/70/50 mm, peso 12,10 kg

4 SUPM1 - supporto a muro a 1 posto per aste Ø 32 mm

5 SUPM2 - supporto a muro a 2 posti per aste Ø 32 mm

6 SUPM3 - supporto a muro a 3 posti per aste Ø 32 mm

7 SUPP1 - supporto a pavimento a 1 posto verticale per aste Ø 32 mm



PROIETTORI LED E IMPIANTI SEQUENZIALI SENZA FILI



ECOSOLAR 201

Lampeggiatori omologati fotovoltaici singoli o doppi (a seconda del modello), rafforzativi, per segnaletica verticale. Composti da: modulo luminoso a led "Basic 200" certificato e omologato UNI EN12352 classe L8H Min. Inf. e Trasp. n° 2665 del 29/07/04 alimentato con pannello solare predisposto per fissaggio su pali Ø mm 60. Funzionamento 24 ore o solo notte. Alimentazione con pannello fotovoltaico. Pronto per l'installazione. Ideale per cuspidi, incroci e punti pericolosi.

- 1 LAS21845** - pannello fotovoltaico da 10W con lampeggiatore doppio (dimensioni (l x h x p): mm 210 x 600 x 120) e cavi di collegamento
- 2 LAS21840** - pannello fotovoltaico da 5W con lampeggiatore singolo (dimensioni (l x h x p): mm 210 x 210 x 120) e cavi di collegamento



3 IMPIANTO DOPPIO BASIC 211

Proiettori a led conformi a UNI EN12352 classe L8H. Consumi ridotti. Scheda lampeggio integrata. Connettore per collegamento rapido IP68 (A). **LAB38940** - doppio flashed (12/24V) compreso di cavi e connettori

IMPIANTI SEQUENZIALI A LED SENZA FILI

Impianti con tecnologia radio bidirezionale. Lampade a LED omologata Ministero Infr. Trasp. secondo UNI EN12352 classe L8H. Minima distanza fra le lampade 1 m, max 80 m. Nessun limite al numero di lampade utilizzabili. Funzioni selezionabili dall'utente: funzionamento crepuscolare, sequenza lenta, luce guida notturna. Durata con 4 batterie @ 25°C tipo 6V 4R25 25Ah: 1600 h (batteria fornibile a richiesta LAPO25). **Altri impianti sequenziali fornibili a richiesta.**

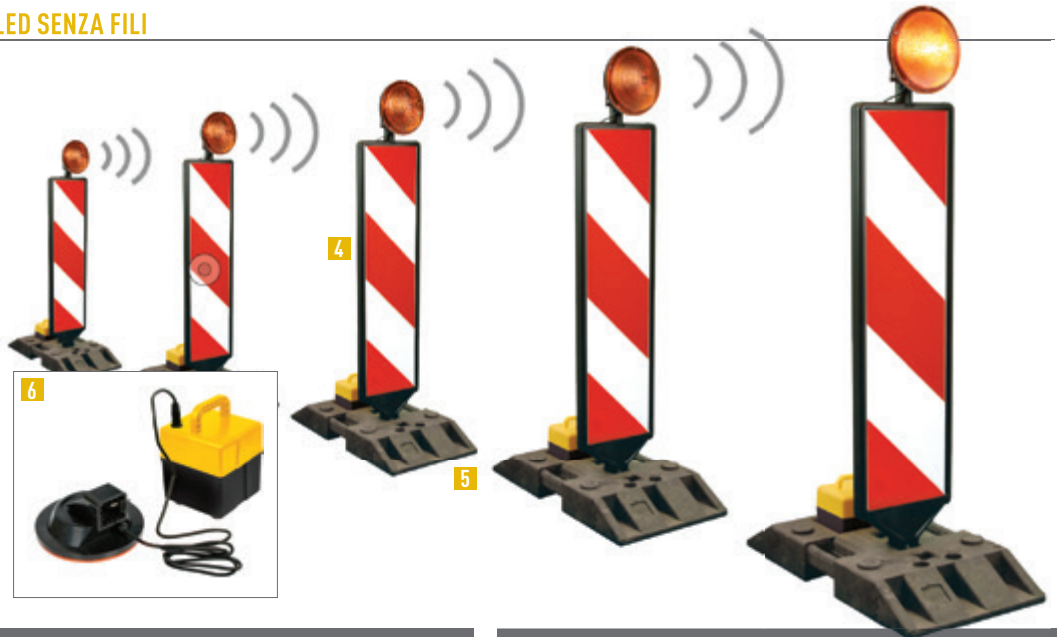

- 4 LAS388** - pannello bifacciale con pellicola EG
- 5 BG028** - base kg 28
- 6 LAS123** - lampada sequenziale via radio; L8H; frequenza lampeggi 60/minuto

FORNIBILE A RICHIESTA

IMPIANTO SEMAFORICO MOBILE A LED

Coppia di semafori a led da cantiere (batteria esclusa). Altezza regolabile da mm 1800 a mm 2050, dimensioni da chiuso 400 x 740 x 420 mm, peso kg 25 (1 semaforo, batterie escluse). Autonomia di funzionamento con batteria 12 V da 90 Ah: 360 ore. Ø mm 200, colori: verde, giallo, rosso. Gestione sequenza centralina elettronica con sincronizzazione al quarzo SQD (senso unico alternato).

LAS25317 - coppia semaforica

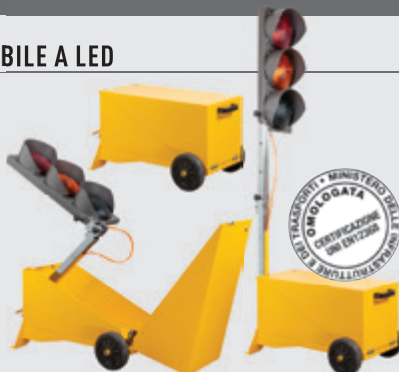

FORNIBILE A RICHIESTA

FRECCIA DIREZIONALE

Freccia direzionale a led. Versione con 8 proiettori Basic 200 approvati e omologati secondo UNI EN 12352. Dimensioni: cm 90 x 90 x 10,5. Peso kg 10,5. Consumi: 30 Ah al giorno, circa 12 V TA 25°C. Applicabile al portasegnaletto CVL135. Alimentazione: 12V.

LAS38381 - freccia direzionale con 8 proiettori a led omologati





A COSA SERVONO I MARKER STRADALI?

I marker stradali possono essere utilizzati per rafforzare i segnali orizzontali in situazioni particolarmente pericolose (curve, dossi, attraversamenti pedonali, isole spartitraffico). Devono avere un'altezza non superiore a 25 mm e devono essere applicati con colla bicomponente o altri sistemi di ancoraggio (tasselli) alla pavimentazione, in modo da evitare distacchi dovuti alla sollecitazione del traffico. Vanno posizionati ai lati delle corsie e devono poter essere facilmente rimossi senza produrre danni al manto stradale. La distanza di posa massima di tali dispositivi è di 10 metri in rettilineo (8 metri in zone particolarmente nebbiose) e di 4 metri in curva.

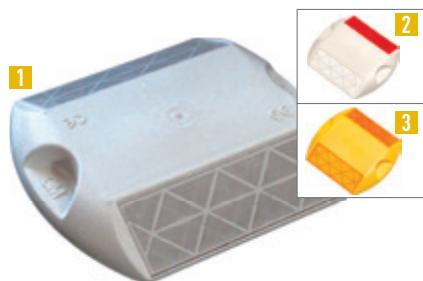

1 DELINEATORI OCCHI DI GATTO



Dispositivi segnalatici retroriflettenti "occhi di gatto" ad alta intensità luminosa. Integrano la demarcazione di corsie. Dimensioni: mm 100 x 87 x 17 h. Minimo ordinabile 10 pezzi/multipli. Confezione da 10 pezzi completa di adesivo bicomponente (1 barattolo + 1 tubetto).

- 1 **MAR291** - colore bianco/bianco
- 2 **MAR290** - colore bianco/rosso
- 3 **MAR292** - colore giallo/giallo

CON PANNELLO SOLARE INTERNO



4 MARKER STRADALE CON PANNELLO SOLARE

Funzionamento notturno, conformi all'art. 153 (Art. 40 C.d.S.), pannello solare interno (necessità di alcune ore di esposizione alla luce diurna). Non carrabile. Cella solare: 2,5V 119mA. Dimensioni mm 110 x 97 x 24,5.

- CTM300Y** - marker lampeggiante giallo
- CTM300W** - marker lampeggiante bianco



5 GLASSTOP E MINIGLASSTOP

Corpo bianco in vetro, funzionamento notturno, conformi all'articolo 153 (Art. 40 C.d.S.). Applicazioni: lati carreggiata, rotonde, gallerie, corsie obbligatorie.

- 5 **CTG400** - GlassTop, resistente > 40 tonnellate; Ø mm 100; h fuori terra mm 19, h da interrare mm 25, peso g 540. **Omologato UNI EN1463-2**
- 6 **CTG407** - MiniglasTop, resistente > 18 tonnellate; Ø mm 50; h fuori terra mm 11,5, h da interrare mm 40, peso g 150. **Certificato UNI EN1463-2**



7 MARKER STRADALE RETRORIFLETTENTE NON CARRELLABILE

Marker retroriflettente 360° a norma **UNI 1463-1 2009**. In policarbonato, copertura trasparente di forma circolare. Fissaggio: forare il manto stradale con una punta da mm 14, riempire con collante chimico (non fornito) e inserire il dispositivo. **Minimo ordinabile 10 pezzi/multipli.**

- 7 **MAR82W** - marker stradale retroriflettente Ø mm 120, altezza massima mm 18,5, peso gr 118, colore bianco
- 8 **MAR82Y** - marker stradale retroriflettente Ø mm 120, altezza massima mm 18,5, peso gr 118, colore giallo

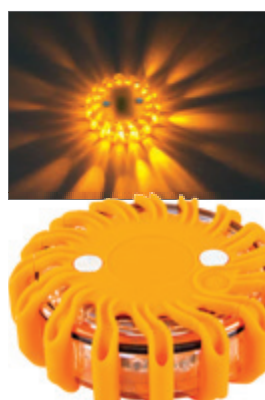

9 LUCE DI EMERGENZA A LED

Per aree di pericolo, incidenti ecc. con 9 modalità differenti di lampeggio, 16 led per unità. Fornita con caricabatteria da rete 220V e con adattatore per accendisigari 12V. Calamita, antiurto e impermeabile. Dimensioni: cm 11 x 3,5. Visibilità a 360°.

- 9 **LAS43047** - luce di emergenza singola ricaricabile, colore arancione
- 10 **LAS43040** - kit 6 luci di emergenza colore arancione, ricaricabili con adattatori 220/12 V in valigetta portatile colore nero, dimensioni cm 36 x 37 x 7,5



11 CATADIOTTRI IN METACRILATO

Con effetto retroriflettente di eccezionale efficacia. Minimo ordinabile 5 pezzi/multipli (tranne CT29R).

Colori: **W** bianco **R** rosso **Y** giallo

- 11 **CT21** - catadiottro, dimensioni mm 128 x 67, interasse fori mm 110
- 12 **CT23** - catadiottro Ø mm 86, con una vite posteriore
- CT33** - catadiottro Ø mm 86, con biadesivo posteriore
- 13 **CT22** - catadiottro, dimensioni mm 160 x 49, interasse fori mm 145
- 14 **CT29R** - catadiottro lato mm 180, solo colore rosso, minimo ordinabile 2 pezzi/multipli



15 CHIODI PER DELIMITAZIONE AREE

Chiodi in acciaio inox AISI 304 Ø mm 100, utilizzati per delimitare aree (passaggi pedonali, parcheggi, ecc). Si fissano tramite colla (non fornita).

- CTMV100** - chiodo in acciaio, dimensioni Ø mm 100 x mm 83 h



LAMPADE DA CANTIERE E OMOLOGATE ADR, TORCE, MISURATORE STRADALE

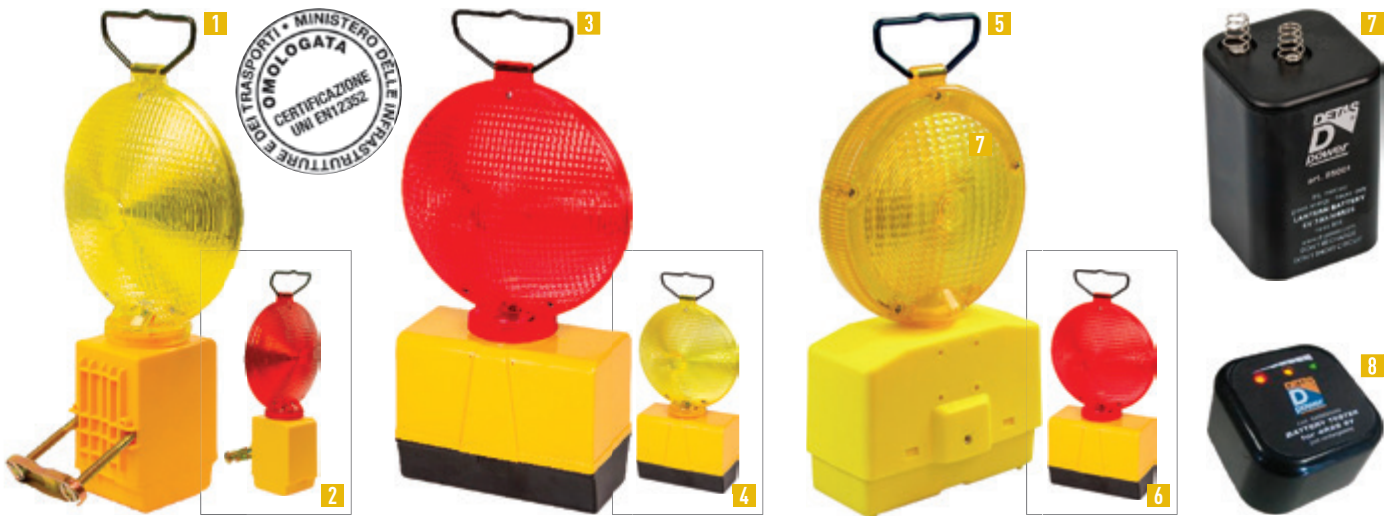

SEGNALATORI LUMINOSI DI OSTACOLI CERTIFICATI

A led, **omologati dal Ministero dell'Infrastrutture e dei Trasporti secondo UNI EN12352**. Corpo e lente (Ø mm 200) bifronte orientabile in plastica antiurto. **Forniti senza batteria.**

- 1 LAL119Y** - segnalatore luminoso con luce gialla bifacciale lampeggiante classe L6. Necessaria 1 batteria 6V 4R25 (non inclusa). Altezza 35 cm. Staffa di fissaggio inclusa
- 2 LAF119R** - segnalatore luminoso con luce rossa bifacciale fissa classe L6. Necessaria 1 batteria 6V 4R25 (non inclusa). Altezza 35 cm. Staffa di fissaggio inclusa
- 3 LAF219R** - segnalatore luminoso con luce rossa bifacciale fissa classe L6. Altezza 35 cm. Necessarie 2 batterie 6V 4R25 (non incluse)
- 4 LAL219Y** - segnalatore luminoso con luce gialla bifacciale lampeggiante classe L6. Altezza 35 cm. Necessarie 2 batterie 6V 4R25 (non incluse)

SEGNALATORI LUMINOSI DI OSTACOLI

A led corpo e lente (Ø mm 180) bifronte orientabile in plastica. **Batteria e staffa di fissaggio escluse** (fornibili a richiesta con staffa di fissaggio).

- 5 LAL217Y** - segnalatore luminoso luce gialla lampeggiante. 2 batterie 6V 4R25 (non incluse)
- 6 LAF217R** - segnalatore luminoso luce rossa fissa. 2 batterie 6V 4R25 (non incluse)

BATTERIA E TESTER

- 7 LAP06E** - batteria a molla 6V 4R25 7Ah, per tutti i tipi di segnalatori luminosi serie LAL e LAF
- 8 LAPT50** - tester per verifica carica batteria

FORNIBILI A RICHIESTA



LAS050 - staffa antifurto per palo fino a Ø 50 mm

LAS080 - staffa antifurto per palo da Ø 50 fino a 80 mm

LAS150 - chiave multifunzione per azionare lampade certificate (compatibile solo con LAL219Y e LAF219R)

SIGNIFICATO COLORI LAPT50

LED ACCESI LIVELLO DI CARICA

● ● ● 70 - 100%

● ● 30 - 70%

● 10 - 30%

○ Batteria scarica o guasta



9 MISURATORE STRADALE

Leggero e robusto, usato per la misurazione su strade e aree di lavoro. Impugnatura a pistola, freno a pulsante e rotella abrasiva per la massima precisione. Ripiegabile all'interno dello zainetto (incluso).

MSE205 - misuratore stradale, peso kg 2,1



10 TORCE A VENTO ANTIROTOLAMENTO

Torçe stradali ad accensione rapida antivento in iuta paraffinata per segnalazioni. Minimo ordinabile 10 pezzi/multipli.

TN80A - torcia antivento in iuta, lunghezza mm 800



! CONFORME AL C.D.S. ART. 181 (ART. 43 C.D.S.)

11 TORCIA A LED

6 led colore rosso lampeggiante o 6 colore verde fisso. Alimentazione 2 batterie 1.5V di tipo "D" (non incluse). Durata batterie > 120 ore a luce lampeggiante. Custodia in policarbonato IP65.

LAS43072 - torcia a 12 led, peso 220 gr, dimensioni 550 x Ø 40 mm



12 LAMPADA A LED OMOLOGATA ADR

La più piccola lampada di emergenza omologata sul mercato, adatta anche al vano porta oggetti delle autovetture. Luce intermittente, fissa e test batterie. Alimentazione 2 batterie 1,5 V (non incluse).

LR216 - lampada a led con interruttore, autonomia 5 ore, dimensioni mm 90 x 208 x 30, peso gr 500



1 TRIANGOLO AUTO FERMA

Composto da 3 pannelli in plastica riflettente ed idrorepellente rivettati su 3 pannelli fluorescenti, supporto in metallo. Fornito con custodia. Dimensioni triangolo: base cm 42 x 45 x 45. Dimensioni custodia in plastica rigida: cm 43,5 x 5,5 x 3,5 h. Omologato secondo il regolamento europeo ECE R 27.

TRI70090 - triangolo auto ferma

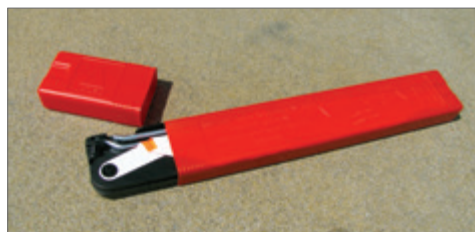

1

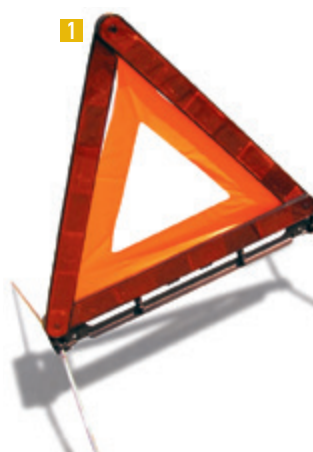

2



KIT ADR

Borsa per autotrasportatori con tracolla e maniglia.

2 BPSV259 - borsa ADR in poliestere 600 vuota

BPSV260 - borsa ADR in poliestere 600 vuota per eventuale equipaggiamento supplementare, dimensioni cm 66 x 33 x 47 h

3 BPS259 - borsa ADR in poliestere 600 con kit, dimensioni: cm 56 x 23 x 37 h



KIT DI ASSORBIMENTO PERDITE SU STRADA A PAGINA 513.

3

SE NON PRESENTE SUL CAMION, È OBBLIGATORIO INTEGRARE IL KIT BASE CON UNA CALZATOIA - COD. KPC95805 (VEDI PAG. 334).



BPS259 - ESEMPIO DI DOTAZIONE KIT ADR

- 2 coni segnaletici CO81
- 1 nastro segnaletico bianco/rosso NS703
- 2 segnalatori luminosi gialli LAL217Y con 4 batterie LAP06E
- 1 tuta in tyvek con cappuccio TYV6XL
- 1 elmetto ELE25Y
- 1 paio di guanti in neoprene GE29500/9
- 1 paio di stivali ZC630144
- 1 maschera pieno facciale RSD999
- 1 filtro ABEK2 HG P3 codice RSD5470
- 1 paio di occhiali a mascherina AP8147

A richiesta fornibile diverso contenuto.

BPSV260 - ESEMPIO DI EQUIPAGGIAMENTO SUPPLEMENTARE

- 1 badile pieghevole antiscintilla FAP611
- 1 tappeto di tenuta UAT8080
- 1 barriera di tenuta UABF200

A richiesta fornibile diverso contenuto.

4



ALTRE VALIGETTE ALLE PAGINE 436-439.

4 VALIGETTA IN PLASTICA

In polipropilene antiurturo con maniglia, dotata di supporto per il fissaggio a parete o su automezzi. Contenuto: presidi medici prescritti dall'Allegato 2 D.M. n. 388.

BRV202 - valigetta colore verde, cm 32 x 21 x 9 h

5



5 ESTINTORE PORTATILE

Estintore portatile a polvere carica ca kg 1, classe 8A 34BC, dimensioni mm 80 x 314, peso kg 2.

EOKB01 - estintore a polvere

6



6 GILET AD ALTA VISIBILITÀ

In poliestere chiusura con velcro, taglia unica regolabile e bande rifrangenti applicate.

GBR07A - gilet alta visibilità colore arancio

GBR07Y - gilet alta visibilità colore giallo





PANNELLI E SISTEMI DI SEGNALAZIONE TRASPORTO MERCI PERICOLOSE (come previsti dalla sezione 5 della attuazione della direttiva 94/55/CE entrata in vigore il 01/01/97).

Estratto Sezione 5:

1. Le unità di trasporto caricate con le merci pericolose debbono avere, disposti in un piano verticale, due pannelli rettangolari di colore arancione retro-riflettente, la cui base è di cm 40 e la cui altezza non deve essere inferiore a cm 30. Questi pannelli debbono portare un bordo nero di spessore non superiore a 15 mm. Essi debbono essere fissati, uno sulla parte anteriore dell'unità di trasporto e l'altro su quella posteriore, perpendicolarmente all'asse longitudinale di questa. Essi debbono essere ben visibili. (...) (A e B: vedi schema).

2. I veicoli cisterna o le unità di trasporto con 1 o più cisterne che trasportano materie pericolose previste all'Appendice B.5, devono in aggiunta, esporre sul lato di ogni cisterna o scomparto, chiaramente visibile e parallelo all'asse longitudinale del veicolo, pannelli colore arancio (...). Su questi pannelli color arancio dovranno apparire i numeri di identificazione previsti (...) (C: vedi schema).

8. I pannelli di colore arancione che non si riferiscono alle merci pericolose trasportate o ai loro residui, devono essere rimossi o ricoperti.

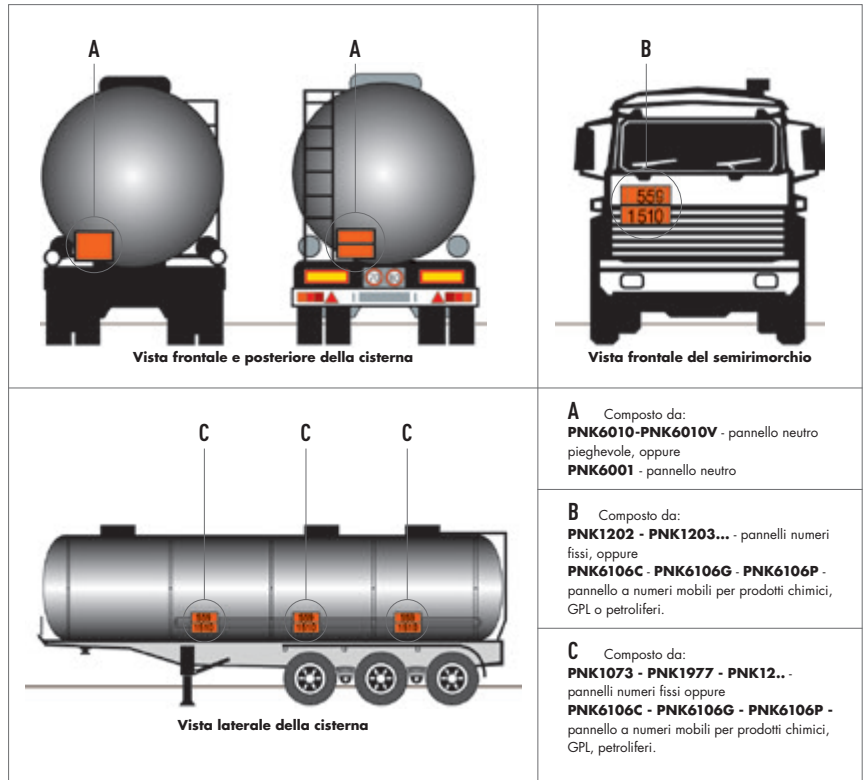

A Composto da:
PNK6010 - PNK6010V - pannello neutro pieghevole, oppure
PNK6001 - pannello neutro

B Composto da:
PNK1202 - PNK1203... - pannelli numeri fissi, oppure
PNK6106C - PNK6106G - PNK6106P - pannello a numeri mobili per prodotti chimici, GPL o petroliferi.

C Composto da:
PNK1073 - PNK1977 - PNK12... - pannelli numeri fissi oppure
PNK6106C - PNK6106G - PNK6106P - pannello a numeri mobili per prodotti chimici, GPL, petroliferi.

Pannelli per segnalazione di trasporto merci pericolose su strada

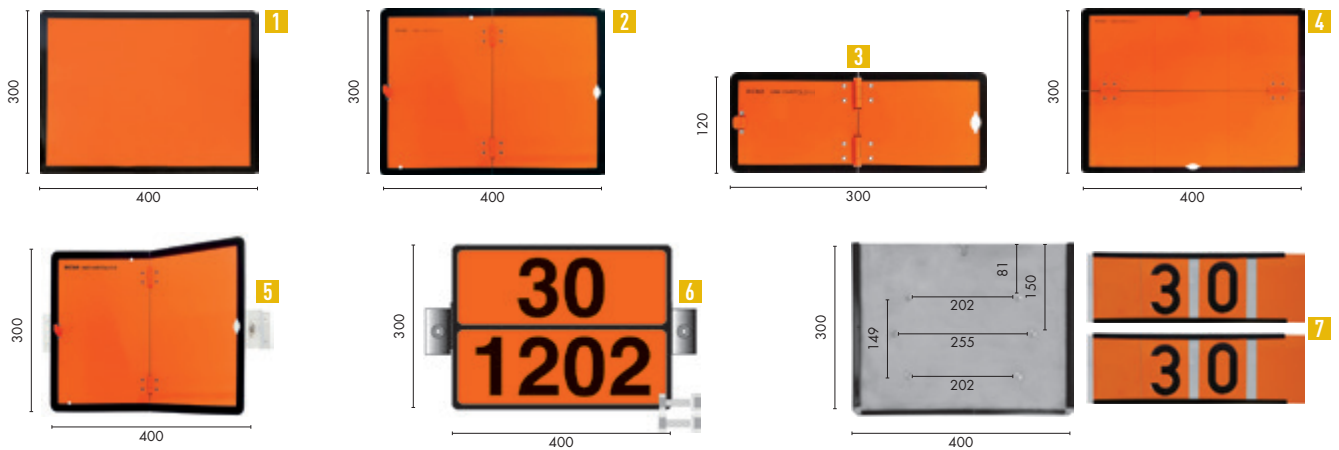

1 PANNELLO GENERICO

PNK6001 - pannello neutro in inox, dimensioni mm 400 x 300, spessore mm 0,8
PNK6001L - pannello neutro in lamiera zincata, dimensioni mm 400 x 300, spessore mm 0,8

2 PANNELLO GENERICO PIEGHEVOLE IN VERTICALE

PNK6010 - pannello neutro pieghevole in inox, dimensioni mm 400 x 300, spessore mm 0,8
PNK6010L - pannello neutro pieghevole in lamiera zincata, dimensioni mm 400 x 300, spessore mm 0,8

3 PANNELLO GENERICO RIDOTTO PIEGHEVOLE IN VERTICALE

Si applica direttamente al mezzo previa foratura a cura dell'utilizzatore in base alle esigenze.
PNK91216 - pannello neutro pieghevole in alluminio, dimensioni mm 300 x 120, spessore mm 2

4 PANNELLO GENERICO PIEGHEVOLE IN ORIZZONTALE

Si applica direttamente al mezzo previa foratura a cura dell'utilizzatore in base alle esigenze.
PNK6010V - pannello neutro pieghevole in lamiera zincata, dimensioni mm 400 x 300, spessore mm 0,8

5 PANNELLO GENERICO PIEGHEVOLE IN VERTICALE CON STAFFA

PNK91207 - pannello neutro pieghevole in alluminio con staffa, dimensioni mm 400 x 300, spessore mm 1

6 PANNELLI IMBOSSATI NON PIEGHEVOLI A NUMERAZIONE FISSA, CON STAFFA

Pannelli imbossati in inox mm 400 x 300, forniti con numerazione fissa e staffa per il fissaggio. Altre numerazioni fornibili a richiesta.

PNK1073 - numeri fissi 225-1073 Ossigeno liquido

PNK1202 - numeri fissi 30-1202 Gasolio

PNK1203 - numeri fissi 33-1203 Benzina

PNK1223 - numeri fissi 30-1223 Cherosene

PNK1977 - numeri fissi 22-1977 Azoto liquido

7 PANNELLI A NUMERI IMBOSSATI INTERCAMBIABILI

Composto da un porta pannello in inox con gancio, dimensioni mm 400 x 300; due slitte in inox per numeri e un kit di numeri imbossati in inox mm 94 x 134. Per l'applicazione al mezzo utilizzare la staffa PNK6018 (fornita separatamente).

PNK6106C - pannello inox, 2 slitte e kit 27 numeri per prodotti chimici

PNK6106G - pannello inox, 2 slitte e kit 10 numeri per GPL

PNK6106P - pannello inox, 2 slitte e kit 10 numeri per petroliferi



Pannelli di segnalazione per trattrici agricole

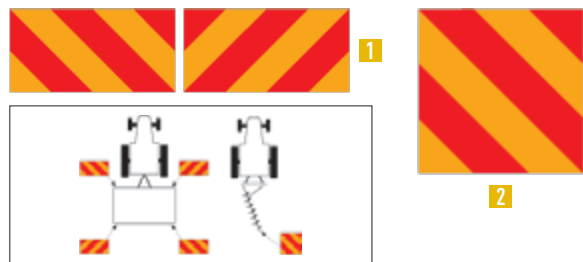

PANNELLI DI SEGNALEZIONE DELLE ATTREZZATURE DELLE TRATTRICI AGRICOLE

Pannelli retroriflettenti e fluorescenti omologati per la segnalazione delle attrezzature portate o semiportate dalle trattrici agricole durante la circolazione su strada. Realizzati con pellicole retroriflettenti classe 2 e fluorescenti. **Decreto Ministeriale 19/06/1992.**

- 1 **PNT2110** - kit 2 pannelli mm 564 x 282 in alluminio piano mm 2
- 2 **PNT2109** - pannello mm 423 x 423 in alluminio piano mm 2



PANNELLI DI SEGNALEZIONE DELLE ATTREZZATURE AGRICOLE CON OMOLOGAZIONE EUROPEA

Pannelli idonei al montaggio su macchine agricole con approvazione di tipo europeo, in accordo al regolamento Europeo ECE 86, valida in tutti i paesi membri dell'Unione Europea. Realizzati in conformità al regolamento ECE 70 classe 5, di colore rosso/bianco, in alluminio spessore 2 mm, con angoli arrotondati.

- 3 **PNT9303** - kit 2 pannelli destro e sinistro mm 423 x 282 in alluminio piano mm 2
- 4 **PNT9305** - kit 2 pannelli destro e sinistro mm 423 x 423 in alluminio piano mm 2
- 5 **PNT9301** - kit 2 pannelli destro e sinistro mm 282 x 282 in alluminio piano mm 2

Accessori e ricambi per il trasporto di merci pericolose su strada



PER SEGNALI SERIE 64...D (PAG. 332)

PER SEGNALI SERIE 94...D (PAG. 332)

- 6 **PNK91298** - porta cartello/etichette in inox con gancio, dimensioni mm 300 x 300 spessore mm 1
- 7 **PNK91073** - piastra in alluminio porta etichette adesive, mm 300 x 300 spessore mm 1
- 8 **PNK6012** - pannello inox con gancio e bordo, dimensioni mm 400 x 300
- 9 **PNK6018** - staffa in inox dimensione mm 396 x 75 per porta cartello PNK6012 e pannelli PNK6001 e PNK6001L
- 10 **PNK91240** - staffa in inox con clip montata, dimensioni mm 400 x 75 per pannelli pieghevoli

11 PANNELLO RETRORIFLETTEENTE PER CARICHI SPORGENTI

PNH140A - pannello retroriflettente per carichi sporgenti in alluminio crudo spessore mm 1 + rifrangente H.I. classe 2. Dimensioni: mm 500 x 500



Dispositivi di segnalazione visiva dei veicoli e dei trasporti eccezionali

(Decreto ministeriale 30/01/1985)



Realizzati con pellicole retroriflettenti classe 2.

- 12 **PN310** - dimensioni: mm 600 x 300, alluminio piano 15/10
- 13 **PN311** - dimensioni: mm 600 x 300, alluminio piano 15/10
- 14 **PN309** - dimensioni: mm 900 x 50, alluminio piano 15/10. Da applicare lateralmente ogni 2 metri
- 15 **PN300** - dimensioni: mm 600 x 150 alluminio piano 15/10
- 16 **PNK7031** - pannello bifacciale mm 1250 x 250, realizzato su pellicola retroriflettente classe 2 applicato su alluminio spessore mm 3



17 ETICHETTE PER SEGNALEZIONE DI TRASPORTO MERCI PERICOLOSE GENERICHE SU STRADA

A richiesta fornibili con specifica numerazione.

- 9433L - 9434L** - pellicola adesiva colore arancio, dimensioni mm 400 x 300, scrivibile con pennarello indelebile
- R9433L - R9434L** - pellicola adesiva autoadesiva rifrangente, dimensioni mm 400 x 300



DISPOSITIVI DI SEGNALAZIONE PER VEICOLI

ATTUAZIONE DEL REGOLAMENTO ECE/ONU N. 70/01 CLASSE 3 SULLE NORME DI OMOLOGAZIONE E INSTALLAZIONE DEI PANNELLI RETTORIFLETTENTI E RETTORIFLETTENTI/FLUORESCENTI PER LA SEGNALAZIONE DEI VEICOLI PESANTI LUNGI (Decreto Ministeriale 24/01/2003 n. 40)

Estratto Regolamento: Art. 1. - Veicoli soggetti all'obbligo dell'installazione dei pannelli posteriori di visibilità:

1. Gli autoveicoli adibiti al trasporto di cose, la cui massa complessiva a pieno carico supera 3,5 t (categorie internazionali N2e N3) devono essere segnalati posteriormente con pannelli retroriflettenti o retroriflettenti e fluorescenti di tipo approvato e conformi...
2. I rimorchi ed i semirimorchi adibiti al trasporto di cose, la cui massa complessiva a pieno carico supera 3,5 t (categorie internazionali O3 e O4), devono essere segnalati posteriormente con pannelli retroriflettenti o retroriflettenti e fluorescenti di tipo approvato e conformi...

Pannelli di segnalazione degli autoveicoli (tutti con Omologazione Ministeriale)



1 PNM3101 - 1 pannello retroriflettente classe 3 e fluorescente in alluminio piano. Dimensioni: mm 1130 x 132, spessore mm 2.



2 PNM3102 - kit 2 pannelli retroriflettenti classe 3 e fluorescenti in alluminio piano. Dimensioni: mm 565 x 132, spessore mm 2.



3 PNM3104 - kit 4 pannelli retroriflettenti classe 3 e fluorescenti in alluminio piano. Dimensioni: mm 285 x 132, spessore mm 2.

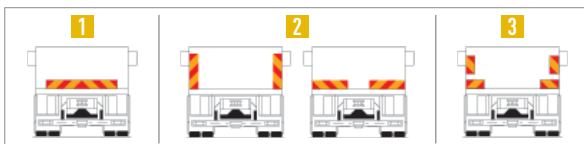

Pannelli di segnalazione dei rimorchi (tutti con Omologazione Ministeriale)



4 PNR3201 - 1 pannello retroriflettente classe 3 e fluorescente in alluminio piano. Dimensioni: mm 1130 x 196, spessore mm 2.



5 PNR3202 - kit 2 pannelli retroriflettenti classe 3 e fluorescente in alluminio piano. Dimensioni: mm 565 x 196, spessore mm 2.



6 PNR3204 - kit 4 pannelli retroriflettenti classe 3 e fluorescenti in alluminio piano. Dimensioni: mm 285 x 196, spessore mm 2.

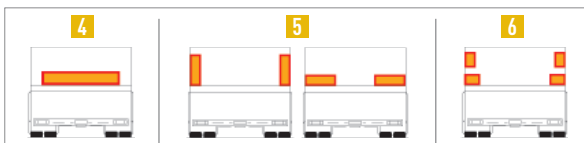

Pellicole ad altissima rifrangenza

REGOLAMENTO ECE/ONU N. 104: OMOLOGAZIONE DEI DELINEATORI RETTORIFLETTENTI PER VEICOLI LUNGI E PESANTI E LORO RIMORCHI (Legge 01/08/2003)

Estratto della Legge 2-bis.:

Durante la circolazione gli autoveicoli i rimorchi ed i semirimorchi adibiti al trasporto di cose nonché classificati per uso speciale o per trasporti specifici, immatricolati in Italia e con massa complessiva a pieno carico superiore a 3,5 t, devono altresì essere equipaggiati con strisce posteriori e laterali retroriflettenti. Le caratteristiche tecniche di tali strisce sono definite con decreto del Ministero delle infrastrutture e dei trasporti, in ottemperanza a quanto previsto dal regolamento internazionale ECE/ONU n. 104.

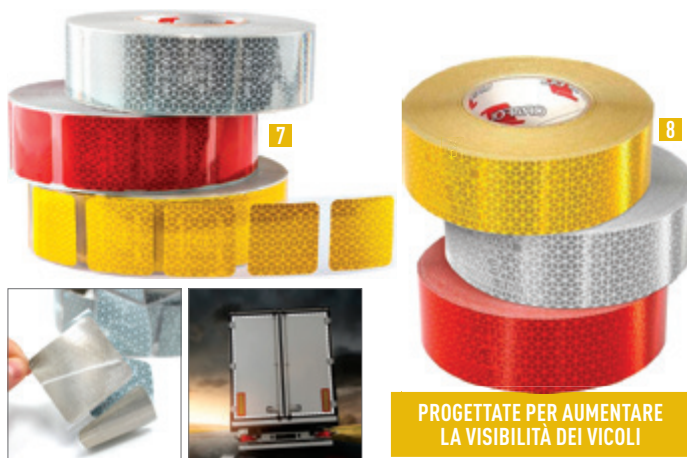

PROGETTATE PER AUMENTARE LA VISIBILITÀ DEI VICOLI

7 PELLICOLA PER SUPERFICI TELONATE REFLEXITE®

Caratterizzata da una costruzione a segmenti che la rende idonea per l'applicazione sulle superfici telonate.

Colori: W bianco R rosso Y giallo

NSR7076. - rotolo pellicola autoadesiva lunghezza 50 m, altezza cm 5

8 PELLICOLA PER SUPERFICI RIGIDE REFLEXITE®

Caratterizzata da una costruzione particolare che la rende idonea per l'applicazione sulle superfici rigide.

Colori: W bianco R rosso Y giallo

NSR7070. - rotolo pellicola autoadesiva lunghezza 50 m, altezza cm 5

NSR7071. - rotolo pellicola autoadesiva lunghezza 12,5 m, altezza cm 5, imballo in blister di plastica trasparente

Contrassegni di velocità



R96 015
R80 015

R96 040
R80 040

R96 060
R80 060

R96 070
R80 070

R96 080
R80 080

R96 090
R80 090

R96 100
R80 100

200

9 CONTRASSEGNI DI LIMITAZIONE PERMANENTE DI VELOCITÀ

Contrassegni Ø mm 200 (Art. 344 D.P.R. 16-12-1992 n° 495). Approvati dal Ministero dei Trasporti.

R96... - pellicola retroriflettente H.I. classe 2, autoadesiva

R80... - pellicola retroriflettente H.I. classe 2, su supporto alluminio spessore 0,5

10 SUPPORTO PER CONTRASSEGNI DI LIMITI DI VELOCITÀ

Materiale: alluminio spessore mm 1.

PNK5001 - supporto singolo Ø mm 200



CONTRASSEGNI PER VEICOLI CONTO TERZI - CONTO PROPRIO

- 1 **PNK9310** - pellicola adesiva conto terzi in PVC, 320 x 160 mm
- 2 **PNK9311** - pellicola adesiva conto proprio in PVC, 320 x 160 mm



PANNELLI RETTORIFLETTENTI SCUOLA GUIDA

Forniti senza supporto. Conformi all'articolo 334, DPR 495 del 16/12/92.

- 3 **PN400** - in PVC rigido + pellicola rifrangente, mm 120 x 150 x 1 (ant.)
- 4 **PN401** - in PVC rigido + pellicola rifrangente, mm 300 x 300 x 1 (post.)
- 5 **PN403** - in alluminio + pellicola rifrangente mm 600 x 150 x 1
- PN404** - come PN403, mm 1000 x 200 x 1
- PN403M** - come PN403, su supporto magnetico
- PN404M** - come PN404, su supporto magnetico



9474 G 9473 G 9475 F H 6475 H

FORMATO ETICHETTE E CARTELLI PER IL TRASPORTO

CODICE	94...	64...
MATERIALE	Etichetta in pellicola plastica autoadesiva	Cartello in alluminio smaltato e serigrafato, spessore 0,7 mm
TIPOLOGIA DI RIFIUTO	a = prodotti deperibili autorizzati d = prodotti deperibili R = rifiuti tossici nocivi	
FORMATO	F = 150 x 150 mm (minimo ordinabile 5 pezzi/multipli) G = 500 x 400 mm H = 400 x 400 mm	



8 PANNELLO IN ALLUMINIO PER VEICOLI AL TRAINO

PN530 - pannello realizzato con pellicole adesive retroriflettenti classe 2, applicate su supporto di alluminio crudo spessore mm 1, mm 500 x 400

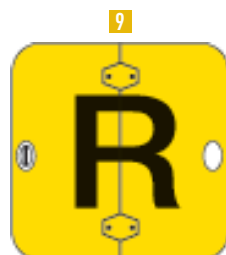

9 R-RIFIUTI

PNK4000 - pannello pieghevole in alluminio, mm 400 x 400, spessore mm 2. Completo di chiavette di fissaggio aperto/chiuso



6



7

PANNELLO CARICO SPORGENTE

- 6 **PN55050** - pannello carico sporgente in PVC rigido bianco/rosso mm 500 x 500, non omologato per uso pubblicitario, con 4 gemme rifrangenti rosse agli angoli e 4 fori rinforzati
- 7 **PN55050P** - pannello come sopra, personalizzato. Minimo ordinabile 100 pezzi

Cartelli "angoli morti"

ART. R.313-32-1 C.D.S. FRANCIA

A partire dal 1° gennaio 2021 è obbligatorio esporre in modo visibile i cartelli indicanti la posizione degli angoli ciechi, per veicoli sia francesi che stranieri, con peso totale a pieno carico superiore a 3,5 t.

DIMENSIONI DEI CARTELLI

CODICE	DIMENSIONI	MATERIALE
66..	170 x 250 mm	Alluminio spessore 0,5 mm
66..S	170 x 250 mm	Pellicola autoadesiva



66001 66001S 66002 66002S

PER CAMION

PER PULLMAN

i SEGNALI DISPONIBILI ANCHE IN VERSIONE ATTACCA/STACCA.



10

10 TARGA PER TRASPORTI IN REGIME TIR

PNK4018 - pannello pieghevole in alluminio, dimensioni mm 400 x 250, spessore mm 1. Completo di chiavette di fissaggio aperto/chiuso



PANNELLI ED ETICHETTE AUTOADESIVE PER TRASPORTO MERCI PERICOLOSE

ETICHETTE PER IL TRASPORTO DI MERCI PERICOLOSE (conformi alla norma internazionale: ADR parte 5).

Sono fornibili a richiesta: i formati **D - F - J**, dove non indicati e le etichette senza testo supplementare.

ETICHETTE E PANNELLI PER IL TRASPORTO DI MERCI PERICOLOSE

FORMATO	A	B	C	D	F	J
DIMENSIONI (mm)	148 x 210	75 x 105	100 x 100	300 x 300	150 x 150	250 x 250
MATERIALE	Codice 94... Pellicola plastica autoadesiva. Minimo ordinabile 5 pezzi/multipli (esclusi formati D e J) Codice 64... Alluminio serigrafato spessore mm 0,7					

! LE ETICHETTE DEL FORMATO F SONO TOLLERATE ESCLUSIVAMENTE PER LA MARCATURA DI CONTAINER E SIMILI, QUANDO LE DIMENSIONI DI DETTI SISTEMI DI TRASPORTO NON PERMETTONO L'UTILIZZO DEI FORMATI D E J.

* A richiesta, fornibili con numero di divisione e lettera di gruppo di compatibilità per la sostanza o l'articolo appropriati.

9431 C	9436 CJD 6436 D	9437 CFJ	9438 C *	9439 C *	9440 CDJ	9441 CJ
9442 CDFJ 6442 D	9443 CJ	9444 CDFJ 6444 D	9445 CDJ 6445 D	9446 C *	9447 CDFJ 6447 D	9448 CDJ
9450 CDJ 6450 D	9451 CD * 6451 D	9452 CDFJ 6452 D	9453 CDFJ 6453 D	9454 CDFJ 6454 D	9455 CDJ 6455 D	9456 CDJ 6456 D
9457 CDFJ 6457 D	9458 CDFJ 6458 D	9459 CD 6459 D	9460 CDJ 6460 D	9461 CDJ 6461 D	9462 CDJ 6462 D	9463 CJ



9449 E
Non caricare sui mezzi aerei destinati a passeggeri.
Etichetta singola mm 125 x 115. Minimo ordinabile 5 etichette/multipli



9464 AB
Teme l'umidità



9465 AB
Alto



9466 AB
Da maneggiare con precauzione



9467 A
Non utilizzare ganci



9468 AB
Teme il calore



9469 B
Da manovrare con precauzione



9470 B
Non lanciare e/o urtare. Da trasportare con mezzo idoneo



9472
etichetta singola mm 350 x 175 h.
Minimo ordinabile 5 etichette/multipli



9471
foglio di 4 etichette mm 146 x 73 h. Minimo ordinabile 5 fogli/multipli



9479 K
etichetta singola mm 110 x 90. Minimo ordinabile 5 etichette/multipli



9478
Materie trasportate a caldo.
Etichetta singola, lato triangolo mm 260. Minimo ordinabile 5 etichette/multipli



9713
foglio da 25 etichette mm 25 x 50. Minimo ordinabile 5 fogli/multipli



9722
etichetta singola mm 100 x 200. Minimo ordinabile 5 etichette/multipli



ETICHETTE PER IL TRASPORTO DI MERCI PERICOLOSE

FORMATO	A	B	L	M	N	P
DIMENSIONI (mm)	50 x 15	135 x 25	100 x 120	100 x 130	245 x 175	300 x 150
MATERIALE	Codice 82... Pellicola plastica autoadesiva. Minimo ordinabile 5 pezzi/multipli					



8201 L



8202 L



8203 L



8204 L



8205 L



8206 L



8207 L



8208 L



8209 L



8210 L



8211 L



8212 L

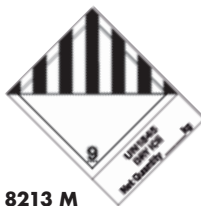

8213 M



8214 M



8215 M



8216 M



8217 N



8218 N



8219 N

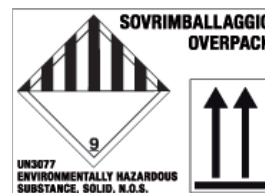

8220 N

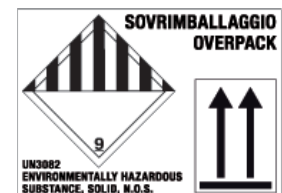

8221 N



8230 P



8231 P



8232 P



8241 - 120 x 40 mm



8237 - 300 x 250 mm



8240 B



8240 A



8242 - 220 x 70 mm



8243 - 300 x 120 mm



CALZATOIE E ARTICOLI PER CAMION



CALZATOIE

- 1 **KPC95805** - calzatoia gialla termoplastica omologata 53 DIN 76051. Dimensioni (b x h x l) 198 x 225 x 467 mm. Peso 1,19 kg
- 2 **KPC95808** - calzatoia in plastica gialla omologata 46 DIN 76051. Dimensioni (b x h x l) 160 x 190 x 383 mm, peso 0,75 kg
- 3 **KPC95810** - calzatoia gialla richiudibile in PP origamy omologata 53 DIN 76051. Dimensioni (b x h x l) 198 x 228 x 463 mm. Peso 0,76 kg

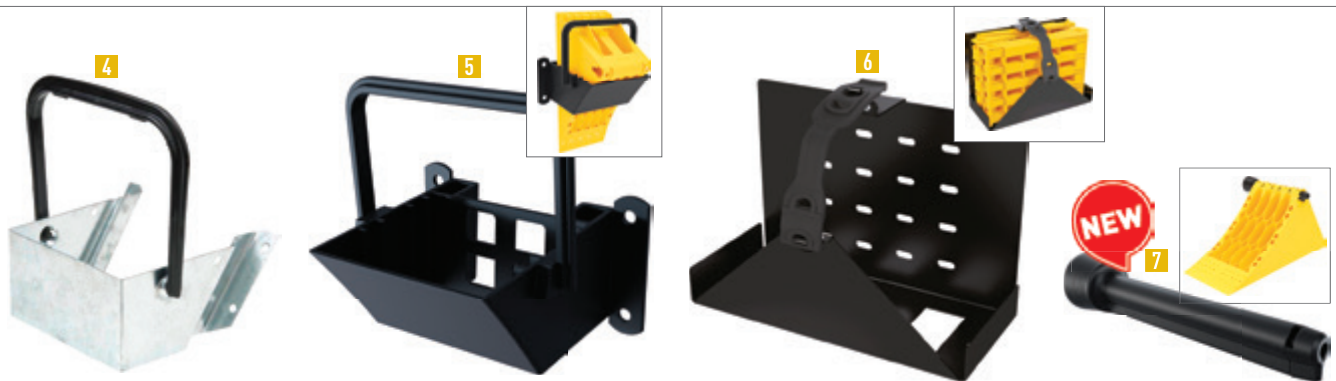

PORTA CALZATOIE

- 4 **KPC95807** - porta calzatoia in acciaio zincato a caldo per KPC95805. Dimensioni (b x h x l) 226 x 248 x 175 mm. Peso 980 gr
- 5 **KPC95809** - porta calzatoia in plastica nera per KPC95808. Dimensioni (b x h x l) 250 x 194 x 228 mm. Peso 430 gr
- 6 **KPC95811** - porta calzatoia in acciaio verniciato nero con molla in PVC per KPC95810. Dimensioni (b x h x l) 166 x 235 x 314 mm. Peso 1,54 kg
- 7 **KPC95812** - porta calzatoia in plastica per KPC95805 e KPC95808. Dimensioni (b x l) 55 x 215 mm. Peso 15 gr



8 CALZATOIA PER CARICHI PESANTI

KPC3011 - in poliuretano leggero e resistente alle intemperie. **Carico massimo 255 tonnellate.** Dimensioni (b x h x l) 550 x 350 x 270 mm. Peso 10,8 kg



9 SERBATOIO ACQUA PER CAMION

KPCS01 - serbatoio per acqua in plastica nera con portasapone "square" lt. 30. Dimensioni (b x h x l) 342,5 x 333 x 421 mm. Peso 2,40 kg

KPCS02 - coppia di staffe zincate per serbatoio KPCS01 con attacco orizzontale. Dimensioni (b x h x l) 73 x 152 x 296 mm. Peso 1,93 kg



10 PORTADOCUMENTI PER CAMION

KPCP01 - portadocumenti rettangolare in PP nero per camion "right". Dimensioni (b x h x l) 74 x 367 x 318 mm. Peso 650 gr





DISPOSITIVI DI PROTEZIONE INDIVIDUALE

PROTEZIONE DELLE VIE RESPIRATORIE, SPAZI CONFINATI, RILEVATORI DI GAS	340-357
PROTEZIONE DELL'UDITO	360-363, 369-370
PROTEZIONE DEL CAPO E DEL VISO	365-370
TORCE DA TESTA E PER ELMETTI	371
PROTEZIONE DEGLI OCCHI	374-379
ABBIGLIAMENTO BOSCAIOLO	379
ABBIGLIAMENTO E ACCESSORI PER LA SALDATURA	380-381
ABBIGLIAMENTO ALLUMINIZZATO	382
ABBIGLIAMENTO MULTIRISCHIO TRIVALENTE E PER ARCO ELETTRICO	383
ABBIGLIAMENTO MULTIRISCHIO E ALTA VISIBILITÀ.....	384-388
ACCESSORI AD ALTA VISIBILITÀ, CAMICI E INDUMENTI ANTIPIOGGIA	389
ABBIGLIAMENTO DA LAVORO	390-393
ABBIGLIAMENTO INTIMO TECNICO.....	394
ARTICOLI RINFRESCANTI E RISCALDANTI	395
ABBIGLIAMENTO E ACCESSORI MONOUSO, PROTEZIONE CHIMICA	397-399
PROTEZIONE DELLE MANI	402-411
INDUMENTI E ACCESSORI IN MAGLIA METALLICA	406
CREME BARRIERA PER LA PROTEZIONE DELLE MANI	412-413
PROTEZIONE DEI PIEDI	415-419
PROTEZIONE DA CADUTE	421-426
PROTEZIONE DALL'ELETTRICITÀ.....	427-429
PROTEZIONE PER LA SALDATURA	430-431
CUSTODIE E ARTICOLI PER DISINFEZIONE D.P.I.....	432



DECALOGO DEI DISPOSITIVI DI PROTEZIONE INDIVIDUALE (D.P.I.)

REGOLAMENTO UE 2016/425

COSA SONO I D.P.I.

I Dispositivi di Protezione Individuale (D.P.I.) sono dispositivi da usare per proteggersi dai rischi che si presentano durante il lavoro.

QUANDO SI DEVONO USARE I D.P.I.

Quando rimane un rischio che non si è riusciti ad eliminare con altri sistemi tecnici o con una diversa organizzazione o metodologia di lavoro.

CHI SCEGLIE I D.P.I. E COMPETENZE

Il datore di lavoro, dopo aver sentito il RSPP ed il medico competente. Chi, in ultima analisi, sceglie i D.P.I., oltre a conoscere i risultati della valutazione dei rischi è anche in grado di utilizzare il contenuto delle norme armonizzate che determinano i requisiti prestazionali, oltre che di salute e sicurezza, del dispositivo scelto. Le informazioni contenute nelle pagine specifiche di prodotto tengono conto di questo prerequisite.

COME SI SCELGONO I D.P.I

Confrontando le informazioni e le norme d'uso fornite dal fabbricante con le caratteristiche dei D.P.I. necessarie per proteggere dai rischi, che non possono essere evitati con altri mezzi, dopo aver effettuato l'analisi e la valutazione.

COSA DEVE FARE IL LAVORATORE

- Partecipare ai corsi di formazione e addestramento predisposti dal datore di lavoro.
- Usare correttamente i D.P.I., come da informazione, formazione e addestramento ricevuti.
- Avere cure dei D.P.I. messi a disposizione senza apportarne modifiche e segnalando al datore di lavoro, dirigente o preposto, eventuali carenze o inconvenienti.

FORMAZIONE E MANUTENZIONE

Una formazione specifica deve essere assicurata per tutti i D.P.I. e, se necessario, un addestramento adeguato. Questo addestramento è indispensabile per i D.P.I. di III categoria; inoltre ogni D.P.I. deve essere mantenuto in efficienza secondo le istruzioni d'uso e le procedure aziendali, ed in particolare alcuni D.P.I. richiedono un registro delle verifiche periodiche (respirazione, anticaduta). Queste verifiche possono essere svolte o in azienda o presso un operatore esterno da personale adeguatamente qualificato e con l'attrezzatura appropriata secondo quanto previsto dal fabbricante o da specifiche norme tecniche.



COME SI SUDDIVIDONO I D.P.I.

I D.P.I. si suddividono in 3 categorie, in base ai fattori di rischio del lavoro da svolgere:

- **Categoria I** - rischi minimi.
- **Categoria II** - rischi diversi da quelli elencati nelle categorie I e III.
- **Categoria III** - rischi che possono causare conseguenze molto gravi, quali morte o danni irreversibili alla salute.



DPI



Certificato

MARCATURA CE DEI D.P.I.

I DPI riportano una marcatura mediante la quale i fabbricanti indicano che i prodotti sono conformi ai requisiti essenziali di salute e sicurezza applicabili di cui all'Allegato II del Regolamento 2016/425 UE. Per i DPI di categoria III, la marcatura CE è seguita dal numero di identificazione dell'organismo notificato che interviene nella procedura di esame UE del tipo e nella valutazione di conformità della produzione al tipo. La marcatura deve contenere almeno:

- identificazione del produttore e suo indirizzo
- modello, tipo, lotto o altra identificazione del DPI
- marcatura prestazionale secondo quanto previsto da norme tecniche armonizzate
- taglia/misura.

CONFORMITÀ:

Categoria I e II CE

Categoria III CE 1234



ISTRUZIONI DEL FABBRICANTE

Le istruzioni fornite obbligatoriamente dal fabbricante con i DPI devono recare, oltre al nome e all'indirizzo del fabbricante, ogni informazione utile concernente:

- le istruzioni di magazzinaggio, di impiego, di pulizia, di manutenzione, di revisione e di disinfezione;
- le prestazioni registrate durante le pertinenti prove tecniche effettuate per verificare i livelli o le classi di protezione dei DPI;
- se del caso, gli accessori che possono essere utilizzati con i DPI e le caratteristiche dei pezzi di ricambio appropriati;
- se del caso, le classi di protezione adeguate a diversi livelli di rischio e i corrispondenti limiti di utilizzo;
- laddove applicabile, il mese e l'anno o il termine di scadenza dei DPI o di alcuni dei loro componenti;
- se del caso, il tipo di imballaggio appropriato per il trasporto;
- il significato delle eventuali marcature;
- il rischio da cui il DPI è destinato a proteggere.

Vista l'importanza di questo documento si deve:

- leggerne attentamente il contenuto assimilandone il significato;
- verificare la coerenza tra le prestazioni del DPI e il rischio dal quale ci si deve proteggere;
- archivarlo in maniera controllata come se fosse un'istruzione per l'uso.

DICHIARAZIONE DI CONFORMITÀ UE

È il documento con il quale si attesta il rispetto dei requisiti essenziali di salute e di sicurezza applicabili di cui all'allegato II del regolamento 2016/425. Il fabbricante fornisce la dichiarazione di conformità UE con il DPI o include nelle istruzioni e nelle informazioni di cui sopra l'indirizzo internet dove è possibile accedere alla dichiarazione di conformità UE. La conformità UE si basa sull'esame da parte di un organismo notificato del tipo di DPI mediante esame della documentazione tecnica del fabbricante, test e prove esula conformità di tutti i prodotti/fabbricati al tipo sottoposto ad esame. La conformità al tipo può basarsi:

- sul controllo interno della produzione, per DPI di categoria II;
- sul controllo interno della produzione unito a prove del prodotto sotto controllo ufficiale effettuate a intervalli casuali oppure sulla garanzia di qualità del processo di produzione (sistema di gestione della qualità certificato), per DPI di categoria III.

PERIODO DI TRANSIZIONE DALLA VECCHIA DIRETTIVA 89/686 CEE AL NUOVO REGOLAMENTO (UE) 2016/425



Transizione di 2 anni.

Art. 47.1... gli Stati membri non ostacolano la messa a disposizione sul mercato dei prodotti contemplati dalla Direttiva 89/686/CEE conformi a tale direttiva e immessi sul mercato anteriormente al 21 aprile 2019.

Art. 47.2 Gli attestati di certificazione CE e le approvazioni rilasciati a norma della Direttiva 89/686/CEE rimangono validi fino al 21 aprile 2023, salvo che non scadano prima di tale data.

PROTEZIONE DELLE VIE RESPIRATORIE: GUIDA ALLA SCELTA



CONTAMINANTI: COME SI PRESENTANO

POLVERI

Particelle solide derivate dalla frammentazione di materiali solidi

NEBBIE

Minuscole goccioline di origine organica o a base acquosa che si formano da operazioni a spruzzo

GAS

Sostanze in fase gassosa a pressione ed a temperatura ambiente, inodori, incolori e si diffondono molto rapidamente

FUMI

Particelle molto fini inferiori ad un micron che si generano quando si fonde un metallo

VAPORI

Sono la forma gassosa di sostanze che si trovano allo stato liquido o solido a temperatura ambiente

INSUFFICIENZA DI OSSIGENO

Si verifica quando la percentuale di ossigeno contenuta nell'aria scende al di sotto del 17%

TIPOLOGIE DI RESPIRATORI

I respiratori a filtro si suddividono in 3 categorie:

- Antipolvere per la protezione da polveri, fumi e nebbie
- Antigas per la protezione da gas e vapori
- Combinati per la protezione contemporanea da particelle e gas/vapori

CLASSIFICAZIONE DEI RESPIRATORI ANTIPOLVERE, EFFICIENZA FILTRANTE

FFP1 - P1: facciale filtrante antipolvere di classe 1, efficienza filtrante minima a respiratore indossato 78%

FFP2 - P2: facciale filtrante antipolvere di classe 2, efficienza filtrante minima a respiratore indossato 92%

FFP3 - P3: facciale filtrante antipolvere di classe 3, efficienza filtrante minima a respiratore indossato 98%

FFP1: livello di protezione fino a 4 volte il TLV

FFP2: livello di protezione fino a 10 volte il TLV

FFP3: livello di protezione fino a 50 volte il TLV

RIFERIMENTI LEGISLATIVI

I mezzi di protezione delle vie respiratorie sono destinati all'impiego in situazioni pericolose e sono perciò classificati nella 3ª Categoria (rischi che possono causare conseguenze molto gravi quali morte o danni alla salute irreversibili). Qualsiasi respiratore venga impiegato deve essere conforme alla norme europee EN. Le principali norme EN di riferimento sono:

EN149+A1: Facciali filtranti antipolvere

EN405: Semimaschere filtranti

EN140: Semimaschere

EN136: Maschere intere

EN143+A1: Filtri antipolvere

EN148: Raccordo filettato per maschere

EN14387: Filtri antigas e combinati

EN137: Autorespiratori ad aria compressa a circuito aperto e maschera a pieno facciale

EN138: Respiratori a presa d'aria esterna per l'uso con maschera intera

EN12941: Dispositivi filtranti a respirazione assistita che integrano caschi o cappucci

EN12942: Apparecchi filtranti a respirazione assistita completi di maschere intere, semimaschere o quarti di maschera

EN1146: Autorespiratori ad aria compressa a circuito aperto con cappucci per evacuazione



ESEMPIO DI SELEZIONE DEL RESPIRATORE ANTIPOLVERE:

L'alluminio ha un **T.L.V.*** pari a 10 microgrammi per metro cubo (mg/m³). Questo significa che fino a questa soglia il lavoratore non necessita di un respiratore. Se nel monitoraggio rischi l'azienda rileva una concentrazione di 40 mg/m³ significa che il **T.L.V.*** viene superato di 4 volte. In questo caso il respiratore da utilizzare è un FFP1 (livello di protezione fino a 4 volte il TLV).

* **T.L.V.:** Valore Limite di Soglia, è la concentrazione media su una giornata di otto ore lavorative e su 40 ore settimanali, alla quale il lavoratore può essere esposto senza effetti negativi sulla salute.

DURATA DEL RESPIRATORE ANTIPOLVERE

La durata del respiratore antipolvere è determinata da due fattori:

- Intasamento del filtro: il lavoratore percepisce un marcato aumento nella resistenza respiratoria
- Decadimento della tenuta al volto: a seguito dell'uso il respiratore tende a perdere la perfetta tenuta al volto, questo comporta una perdita dai bordi.

(Quest'ultimo fattore è valido solo per i facciali filtranti usa e getta e NON per semimaschere e maschere a pieno facciale, per le quali l'unico fattore che determina la durata è l'intasamento del filtro)

CLASSIFICAZIONE DEI FILTRI ANTIGAS, EFFICIENZA FILTRANTE

TIPO	COLORE	PROTEZIONE
A	Marrone	Vapori e gas organici, punto di ebollizione superiore a 65°C
AX	Marrone	Vapori e gas organici, punto di ebollizione inferiore a 65°C
B	Grigio	Vapori e gas inorganici
E	Giallo	Vapori e gas acidi
K	Verde	Ammoniaca e derivati
P	Bianco	Polveri, fumi
CO	Nero	Monossido di carbonio
Hg	Rosso	Vapori di mercurio

CLASSIFICAZIONE PER CAPACITÀ

CLASSE 1: bassa capacità - efficienza filtrante fino a 1.000 particelle per metro cubo (ppm)

CLASSE 2: media capacità - efficienza filtrante fino a 5.000 particelle per metro cubo (ppm)

CLASSE 3: alta capacità - efficienza filtrante fino a 10.000 particelle per metro cubo (ppm)

Le Classi si differenziano per la capacità, cioè per la quantità di contaminante che il filtro è in grado di assorbire e quindi la durata. L'efficienza filtrante è sempre al 100%.

DURATA DEI FILTRI ANTIGAS

La durata di un filtro dipende da molti fattori fra i quali: natura e concentrazione del contaminante, umidità, temperatura e flusso respiratorio. Di conseguenza al numero e tipologie di varianti, non è possibile stabilire una durata teorica di un filtro. Il filtro va sostituito quando l'utilizzatore avverte l'odore o il sapore del contaminante; ciò avviene quando il carbone attivo è saturo e ha quindi esaurito la sua capacità di assorbimento.

NB: i respiratori a filtro vanno utilizzati per sostanze con soglia olfattiva inferiore al T.L.V. affinché sia possibile da parte dell'utilizzatore avvertire l'esaurimento del filtro prima che abbia inalato quantità a rischio della sostanza stessa.

CONCLUSIONE

I respiratori devono essere selezionati in base ad ogni situazione: quindi occorre innanzitutto verificare se impiegare un respiratore antigas, antipolvere, una combinazione dei due o isolare completamente l'utilizzatore dall'aria ambiente.

UTILIZZARE UN DISPOSITIVO ISOLANTE SE:

- La concentrazione di ossigeno è inferiore al 17%
- La concentrazione di sostanza contaminanti è sconosciuta o troppo elevata
- Il filtro non è adatto per le sostanze contaminanti presenti





Serie Aura™ 9300+ Comfort



MASSIMO COMFORT E TENUTA.

9310+ E 9312+



Per polveri tossiche, fumi e nebbie. Impacchettato singolarmente. Efficienza filtrante del 78% fino a 4 volte il TLV. Settori di impiego: metalmeccanica, tessile ed edilizia. **Norma: EN149:2001+A1:2009. Classe: FFP1 NR D.**

- 1 **AP9310** - minimo ordinabile 20 pezzi/multipli
- 2 **AP9312** - come AP9310 **con valvola**. Minimo ordinabile 10 pezzi/multipli

9320+ E 9322+



Per polveri nocive, fumi e nebbie a base acqua. Impacchettato singolarmente. Efficienza filtrante del 92% fino a 12 volte il TLV. Settori di impiego: industrie del legno, cemento, vetro, mineraria, fonderie, edilizia, agricoltura, cantieri navali, chimica, farmaceutica, ceramica, segherie, materiali refrattari, produzione metalli. **Norma: EN149:2001+A1:2009. Classe: FFP2 NR D.**

- 3 **AP9320** - minimo ordinabile 20 pezzi/multipli
- 4 **AP9322** - come AP9320 **con valvola**. Minimo ordinabile 10 pezzi/multipli

9330+ E 9332+



Per polveri tossiche e fumi. Impacchettato singolarmente. Efficienza filtrante del 98% fino a 50 volte il TLV. Utilizzabili in presenza di fibre di amianto e polveri tossiche ove non siano richieste semimaschere o maschere a pieno facciale. Settori di impiego: metalmeccanica, edilizia, saldatura, cantieri navali, processi chimici, farmaceutica, fonderie, acciaierie. **Norma: EN149:2001+A1:2009. Classe: FFP3 NR D.**

- 5 **AP9330** - minimo ordinabile 20 pezzi/multipli
- 6 **AP9332** - come AP9330 **con valvola**. Minimo ordinabile 10 pezzi/multipli

Serie 8300 Comfort



COMFORT E MASSIMA RESISTENZA.

7 8310



Per polveri tossiche, fumi e nebbie. Efficienza superiore al 78% per particelle aventi granulometria media di 0,6 micron. Forma a conchiglia, ampio bordo di tenuta perimetrale. Impieghi: agricoltura, piastrellatura/sbozzatura, abrasione ruggine/ferro, trattamento ceramica. Massimo utilizzo: 4 x TLV del particolato. **Norma: EN149:2001+A1:2009. Classe: FFP1 NR D.**

AP8310 - minimo ordinabile 10 pezzi/multipli

8 8320 E 8322



Per polveri tossiche, fumi e nebbie. Efficienza superiore al 92% per particelle aventi granulometria media di 0,6 micron. Forma a conchiglia, ampio bordo di tenuta perimetrale. Impieghi: carteggiatura/taglio legni dolci, edilizia, metalmeccanica, manutenzione impianti, manipolazione cemento/gesso, verniciatura a pennello. Massimo utilizzo: 10 x TLV del particolato. **Norma: EN149:2001+A1:2009. Classe: FFP2 NR D.**

- 8 **AP8320** - minimo ordinabile 10 pezzi/multipli
- 9 **AP8322** - come AP8320 **con valvola**, minimo ordinabile 10 pezzi/multipli

10 8833



Con valvola per polveri tossiche e fumi nella classica forma a conchiglia. Efficienza filtrante del 98% fino a 50 volte il TLV. Utilizzabile in presenza di fibre di amianto (non per lavori di asportazione). Settori di impiego: metalmeccanica, edilizia, saldatura, cantieri navali, processi chimici, farmaceutica, fonderie, acciaierie. **Norma: EN149:2001+A1:2009. Classe: FFP3 RD.**

AP8833 - minimo ordinabile 10 pezzi/multipli

Serie 8000 Classic



8810, 8822 E 8832 CLASSIC(A CONCHIGLIA)



Per polveri tossiche e fumi. Per polveri nocive con TLV superiore a 0,1 mg/m³ quali: carbone, silice, ferro e composti, manganese, presenti nell'industria mineraria, farmaceutica, dell'acciaio e meccanica. Efficienza superiore al 92%. Massimo utilizzo: 12 x TLV del particolato. **Norma: EN149:2001+A1:2009. Classe: FFP2 NR D.**

- 11 **AP8810** - minimo ordinabile 20 pezzi/multipli
- 12 **AP8822** - come AP8810 **con valvola**, minimo ordinabile 10 pezzi/multipli
- 13 **AP8832** - come AP8810 **con valvola**, classe FFP3 NR D, minimo ordinabile 24 pezzi/multipli

8710 E 8812 CLASSIC (A CONCHIGLIA)



Per polveri nocive. Protezione da polveri aventi TLV di circa 10 mg/m³. Efficienza filtrante superiore al 78%. Impieghi: industria del vetro, cemento, ceramica, acciaio, chimica, tessile, meccanica e farmaceutica. Massimo utilizzo: 4 x TLV del particolato. **Norma: EN149:2001+A1:2009. Classe: FFP1 NR D.**

- 14 **AP8710** - minimo ord. 20 pezzi/multipli
- 15 **AP8812** - come AP8710 **con valvola**, minimo ordinabile 10 pezzi/multipli



Serie 8000 Premium



RIUTILIZZABILI!



1 8825+



Protezione da aerosol solidi o liquidi senza tossicità specifica e a bassa tossicità, in concentrazione fino a 12 x TLV. Modello con valvola di espirazione, nuovo bordo di tenuta senza stringinaso, molto flessibile per aderire perfettamente alle diverse forme di naso e occhi e per una miglior tenuta lungo tutto il bordo facciale. Elastici blu regolabili in 4 punti. Norma: EN149:2001+ A1:2009 Classe FFP2 R D.

AP88250 - con valvola, minimo ordinabile 5 pezzi/multipli

2 8835+



Protezione da aerosol solidi o liquidi senza tossicità specifica, a bassa tossicità e ad alta tossicità, in concentrazione fino a 50 x TLV. Guarnizione di tenuta lungo tutto il bordo facciale. Elastici di colore rosso regolabili in 4 punti. Norma: EN149:2001+A1:2009 Classe FFP3 R D.

AP88350 - con valvola, minimo ordinabile 5 pezzi/multipli

AP88351 - come AP88350 ma in confezione singola

Serie 9000 con carboni attivi

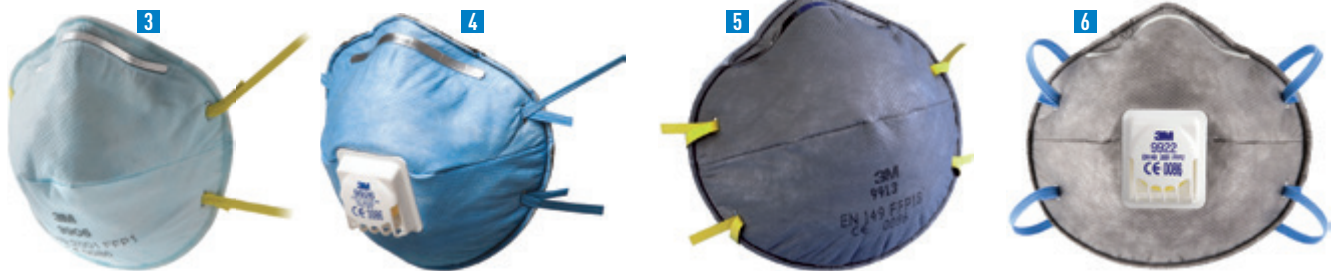

3 9906



Per polveri, nebbie, vapori di acido fluoridrico. Idoneo per protezione da polveri e concentrazioni di vapori di acido fluoridrico inferiori al TLV grazie a uno speciale strato di carbone attivo. Impieghi: industria primaria dell'alluminio, chimica, farmaceutica, del vetro. Massimo utilizzo: 4 x TLV del particolato (sotto il TLV per acido fluoridrico). **Norma: EN149:2001+A1:2009. Classe: FFP1 NR D.**

AP9906 - minimo ordinabile 20 pezzi/multipli

4 9926



Per polveri, nebbie, gas acidi e cloro. Protegge da polveri e da concentrazioni inferiori al TLV di gas acidi e cloro. Impieghi: industria primaria dell'alluminio, manutenzione impianti di combustione a carbone e/o olio, industria della carta e del vetro. Massimo utilizzo: 12x TLV del particolato (sotto il TLV per gas acidi e cloro). **Norma: EN149:2001+A1:2009. Classe: FFP2 NR D.**

AP9926 - con valvola, minimo ordinabile 10 pezzi/multipli

9913 E 9914



Per polveri, nebbie, vapori organici. Dotati di uno strato di carbone attivo, sono ideati in situazioni d'impiego dove, alla protezione dalle polveri, si aggiunge la necessità di trattenere gli odori sgradevoli e le esalazioni di sostanze organiche presenti in concentrazione inferiori al TLV. Impieghi: verniciature a pennello, sgrassature con solventi, manutenzione impianti acque di scarico. Massimo utilizzo: 4 x TLV del particolato. **Norma: EN149:2001+A1:2009. Classe: FFP1 NR D.**

5 AP9913 - minimo ordinabile 20 pezzi/multipli

6 AP9914 - come AP9913 con valvola, minimo ordinabile 10 pezzi/multipli

6 9922



Per polveri, nebbie, vapori organici, ozono. Dotati di uno strato di carbone attivo, ideati in situazioni d'impiego dove è richiesta protezione da polveri e da odori sgradevoli dovuti a vapori organici presenti in concentrazione inferiori al TLV. Inoltre offre protezione da ozono fino ad una concentrazione di 10 volte il TLV. Impieghi: verniciature a pennello, sgrassature con solventi, manutenzione impianti acque di scarico e saldatura. Massimo utilizzo: 10 x TLV del particolato. **Norma: EN149:2001+ A1:2009. Classe: FFP2 NR D.**

AP9922 - con valvola, minimo ordinabile 10 pezzi/multipli

Serie 9000 per fumi di saldatura ed ozono



7 9925 SPECIALE PER FUMI DI SALDATURA E OZONO



Per polveri e fumi specifico per saldatura, nebbie e ozono. Trattato con agenti ritardanti anti-fiamma. Realizzato specialmente per operazioni di saldatura, protegge contro polveri nocive con TLV superiore a 0,1 mg/m³ contro fumi di rame, ferro, piombo e zinco. **Grazie ad uno strato di carbone attivo, è idoneo per concentrazioni di ozono fino a 10 x TLV (saldatura ad arco su alluminio e inox).** Impieghi: operazioni di saldatura e nelle fonderie. Massimo utilizzo: 10 x TLV del particolato. **Norma: EN149:2001+A1:2009.** Minimo ordinabile 10 pezzi/multipli.

AP9925 - con valvola. **Classe: FFP2 NR D**

Serie 9000 per settore alimentare



8 9000 PER SETTORE ALIMENTARE



Per polvere di farina, additivi enzimatici, proteine dell'uovo, proteine di pesce, spezie, polvere di caffè, pulizia e manutenzione. Nel settore farmaceutico può essere utilizzata per produzione capsule e per la versione P3 anche per la micronizzazione. Massimo utilizzo: 12 x TLV del particolato (FFP2), 50 x TLV del particolato (FFP3). **Minimo ordinabile 10 pezzi/multipli. Norma: EN149:2001+A1:2009.**

AP9422 - con valvola, classe: FFP2 NR D

AP9432 - con valvola, classe: FFP3 NR D



Caratteristiche generali dei facciali filtranti

TECNOLOGIA CON FILTRO PIEGHETTATO (SERIE AIR PLUS)

- **260%** di superficie filtrante in più
- Resistenza respiratoria estremamente bassa
- Alta capacità filtrante



ActivForm®
Si adatta automaticamente ai diversi profili del viso - non è necessario alcun tipo di stringinaso

Valvola Ventex® (versioni con valvola)
Grande apertura, riduce il calore e l'umidità, il flusso verso il basso evita i problemi di appannamento

Clip (serie Smart, Smart Pocket e Air Plus)

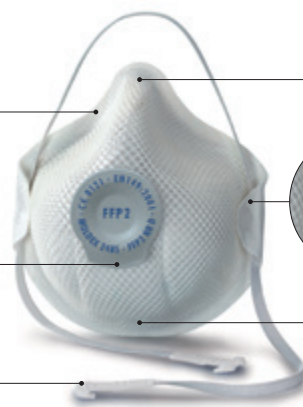

Flangia nasale (serie Smart e Air Plus)
Una confortevole flangia nella zona del naso

Un solo elastico ad anello
Utilizzo veloce, facile e sicuro

Duramesh®
Struttura resistente e durevole, mantiene la forma del respiratore evitando il collasso



SERIE CLASSIC

Per polveri fini, nebbie/aerosol a base acquosa e oleosa. Efficienza filtrante minima dell'80% fino a 4 volte il TLV. Contro polveri non tossiche quali per esempio, ossido di alluminio, bauxite, borace, polvere di mattoni, cellulosa, cemento, polvere di carbone, gesso, calcare, intonaco, cemento Portland, pollini, saccarosio, zucchero. **Norma EN149:2001+A1:2009.**

- 1 APM2360** - minimo ordinabile 20 pezzi/multipli. **Classe FFP1 NR D**
- 2 APM2365** - con valvola, minimo ordinabile 20 pezzi/multipli. **Classe FFP1 NR D**

Per polveri fini tossiche, fumi, nebbie/aerosol a base acquosa e oleosa. Efficienza filtrante minima del 94% fino a 12 volte il TLV. Come FFP1 ma in concentrazioni maggiori, in più: polveri di freni, ossido di calcio, porcellana, calcestruzzo, polvere di cotone, granito, fieno, polvere e fumo di piombo, particolato da fumi di saldatura (non di metalli altamente tossici), silicio, idrossido di sodio, polvere di legno (legni teneri), fumo di ossido di zinco. **Norma EN149:2001+A1:2009.**

- 1 APM2400** - minimo ordinabile 20 pezzi/multipli. **Classe FFP2 NR D**
- 2 APM2405** - con valvola, minimo ordinabile 20 pezzi/multipli. **Classe FFP2 NR D**

Per polveri fini tossiche, fumi, nebbie/aerosol a base acquosa e oleosa. Efficienza filtrante minima del 99% fino a 50 volte il TLV. Come FFP2 ma in concentrazioni maggiori, in più: fibra di ceramica, cromati, cobalto, nickel, microrganismi, aerosol radioattivi e biochimici attivi. **Norma EN149:2001+A1:2009.**

- 2 APM2555** - con valvola, minimo ordinabile 20 pezzi/multipli. **Classe FFP3 NR D**



SERIE SMART

Modelli con flangia nasale e clip per facilitare le operazioni di indossamento. **Norma EN149:2001+A1:2009.**

- 3 APM2380** - minimo ordinabile 20 pezzi/multipli. **Classe FFP1 NR D**
- 4 APM2385** - con valvola, minimo ordinabile 20 pezzi/multipli. **Classe FFP1 NR D**
- APM2485** - con valvola, minimo ordinabile 20 pezzi/multipli. **Classe FFP2 NR D**
- APM2505** - con valvola, minimo ordinabile 10 pezzi/multipli. **Classe FFP3 NR D**



5 SERIE SMART ACTIVE



Stesse caratteristiche della serie Smart. Per polveri fini tossiche, fumi, nebbie/aerosol a base acquosa e oleosa. Efficienza filtrante minima del 94% fino a 12 volte il TLV. **Norma EN149:2001+A1:2009. Classe FFP2 NR D.**

APM2435 - aree di impiego con concentrazioni inferiori al TLV: gas acidi (cloruro di idrogeno, fluoruro di idrogeno, biossido di zolfo), vapori organici, odori sgradevoli (alcol per pulizie, solventi per vernici). Con valvola, minimo ordinabile 10 pezzi/multipli

APM2445 - aree di impiego con concentrazioni 10xTLV: ozono fumi di saldatura (rame, ferro, magnesio, manganese acciaio, zinco). Con valvola, minimo ordinabile 10 pezzi/multipli

6 SERIE AIR PLUS



Modelli con bassissima resistenza respiratoria ed alta capacità filtrante grazie alla tecnologia con filtro piegheggiato. Clip regolabile, flangia di tenuta completa in elastomero lavabile e riutilizzabile. **Norma EN149:2001+A1:2009.**

APM3305 - con valvola, minimo ordinabile 5 pezzi/multipli. **Classe FFP2 R D**

APM3405 - con valvola, minimo ordinabile 5 pezzi/multipli. **Classe FFP3 R D**

7 SERIE COMPACT MASK



Faciale filtrante per gas, vapori e polveri, realizzato in un unico pezzo in confezione richiudibile. Munito di valvola di espirazione e due elementi filtranti a carboni attivi. Non necessita di manutenzione o parti di ricambio, quando i filtri sono esauriti il respiratore viene eliminato. **Norma EN405:2001+A1:2009.**

APM5120 - per vapori organici, polveri e nebbie, **classe FFA1P2 R D**, peso gr 210

APM5230 - per vapori organici, polveri e nebbie, **classe FFA2P3 R D**, peso gr 250

APM5330 - per vapori organici, inorganici gas acidi, polveri e nebbie, **classe FFABE1 P3 R D**, peso gr 270

APM5430 - per vapori organici, inorganici, gas acidi, ammoniac, polveri e nebbie, **classe FFABEK1 P3 R D**, peso gr 270



Caratteristiche generali dei facciali filtranti

RESISTENZA RESPIRATORIA FINO AL 71% INFERIORE AI REQUISITI NORMATIVI

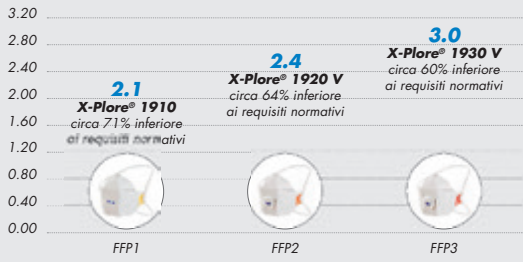

Materiale interno morbido e resistente all'umidità per un comfort di lunga durata

Ripiegabile in tre parti per un'aderenza ottimale al viso e un posizionamento stabile della maschera

Fascette elastiche VarioFLEX antistrappo facilitano l'indossamento della maschera con il massimo comfort

Stringinaso flessibile e morbido cuscinetto nasale per una tenuta sicura senza fastidio

Design SmartFOLD con doppio rinforzo brevettato offre più spazio per la respirazione e un corpo maschera resistente

Valvola di espirazione CoolMAX espelle efficacemente all'esterno l'aria espirata calda e umida

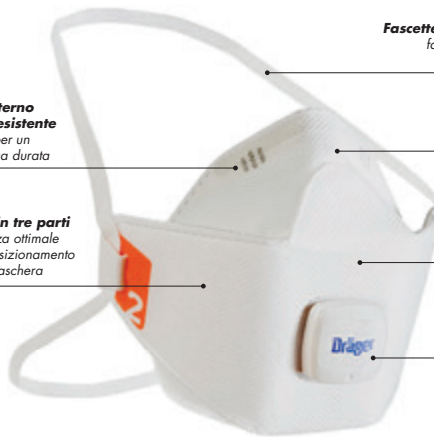

FACCIALI FILTRANTI SERIE X-PLORE® 1900



Facciale filtrante monouso, massimo comfort, alte prestazioni per la protezione contro polveri fini e particelle. Semplice da utilizzare, comfort eccezionale e aderenza ottimale per garantire il massimo livello di sicurezza, anche per l'uso in combinazione con occhiali protettivi. Design pratico e innovativo (è possibile ripiegarla in tre parti), latex free. Imbustata singolarmente. Taglia M/L (a richiesta taglia S per donne o visi minuti). **Norma: EN149:2001+A1:2009.**

- 1 RSD1915** - X-plore® 1910V. Facciale filtrante FFP1 con valvola. Efficienza filtrante del 78% fino a 4 volte il TLV. Minimo ordinabile: 10 pezzi/multipli
- RSD1910** - X-plore® 1910. Facciale filtrante FFP1 senza valvola. Minimo ordinabile: 20 pezzi/multipli
- 2 RSD1925** - X-plore® 1920V. Facciale filtrante FFP2 con valvola. Efficienza filtrante del 78% fino a 4 volte il TLV. Minimo ordinabile: 10 pezzi/multipli
- RSD1920** - X-plore® 1920. Facciale filtrante FFP2 senza valvola. Minimo ordinabile: 20 pezzi/multipli
- 3 RSD1935** - X-plore® 1930V. Facciale filtrante FFP3 con valvola. Efficienza filtrante del 98% fino a 30 volte il TLV. Minimo ordinabile: 10 pezzi/multipli
- RSD1930** - X-plore® 1930. Facciale filtrante FFP3 senza valvola. Minimo ordinabile: 20 pezzi/multipli



FACCIALI FILTRANTI SERIE X-PLORE® 1700



Facciale filtrante monouso ripiegabile in due, massimo comfort, alte prestazioni per la protezione contro polveri fini e particelle. Semplice da utilizzare, comfort eccezionale e aderenza ottimale, grazie alla forma ergonomica, per garantire il massimo livello di sicurezza. Elastico morbido e a prova di strappo, latex free. Imbustata singolarmente. Taglia M/L. **Norma: EN149:2001+A1:2009.**

- 4 RSD1710** - X-plore® 1710. Facciale filtrante antiparticelle FFP1. Minimo ordinabile: 20 pezzi/multipli
- RSD1710V** - X-plore® 1710. Facciale filtrante antiparticelle FFP1 con valvola. Minimo ordinabile: 10 pezzi/multipli
- RSD1710A** - X-plore® 1710. Facciale filtrante antiparticelle FFP1 antiodore. Minimo ordinabile: 20 pezzi/multipli
- RSD1710AV** - X-plore® 1710. Facciale filtrante antiparticelle FFP1 antiodore con valvola. Minimo ordinabile: 10 pezzi/multipli
- 5 RSD1720** - X-plore® 1720. Facciale filtrante antiparticelle FFP2. Minimo ordinabile: 20 pezzi/multipli
- RSD1720V** - X-plore® 1720. Facciale filtrante antiparticelle FFP2 con valvola. Minimo ordinabile: 10 pezzi/multipli
- RSD1720AV** - X-plore® 1720. Facciale filtrante antiparticelle FFP2 antiodore con valvola. Minimo ordinabile: 10 pezzi/multipli
- 6 RSD1730** - X-plore® 1730. Facciale filtrante antiparticelle FFP3. Minimo ordinabile: 20 pezzi/multipli
- RSD1730V** - X-plore® 1730. Facciale filtrante antiparticelle FFP3 con valvola. Minimo ordinabile: 10 pezzi/multipli



1



1 SEMIMASCHERA X-PLORE 4790



Struttura composta da tre particolari componenti; corpo rigido per sostenere il filtro, indossamento veloce e comodo, sistema di bardatura antiscivolo. Conforme alla norma EN140.

RSD320 - semimaschera X-PLORE 4790 in silicone, taglia M/L

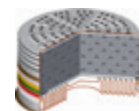

FILTRI PER X-PLORE 4790

CODICE	CLASSE
RSD6712	A2
RSD6719	A1 - B1 - E1 - K1
RSD6729	A1 - B1 - E1 - K1 - P2 R D
RSD6732	A2 - P3 R D
RSD6734	A2 - B2 - P3 R D
RSD6738	A1 - B1 - E1 - K1 - HG - P3 R D
RSD7190	P3



2



i DRÄGER GARANTISCE PER TUTTI I FILTRI UNA SCADENZA DI 4 ANNI (DATA STAMPATA SU OGNI FILTRO). I FILTRI APERTI ANCHE SE MAI UTILIZZATI DEVONO ESSERE USATI ENTRO 6 MESI. NORME DI RIFERIMENTO: EN14387:2004 - EN143:2000.

2 SEMIMASCHERA X-PLORE 3300



Semimaschera a doppio filtro con attacco a baionetta in TPE (TecnoPolimero Espanso), materiale allergico morbido, confortevole, inattaccabile ai solventi. Peso gr 95. A norma EN140.

RSD330 - semimaschera X-PLORE 3300, taglia M

RSD332 - semimaschera X-PLORE 3300, taglia L



FILTRI PER X-PLORE 3300

CODICE	CLASSE
RSD8005	A1
RSD8006	A2
RSD8007	A1 - B1 - E1 - K1
RSD8011	P3
RSD8015	A1 - P3 R D
RSD8016	A2 - P3 R D
RSD8017	A1 - B1 - E1 - K1 - HG - P3 R D

FILTRI ANTIPOLVERE USO SINGOLO O COMBINATO CON FILTRI ANTIGAS (tramite adattatore **RSD8356**)

RSD8353	P2
RSD8354	P3
RSD8391	P3 + carboni attivi

Per tutti i filtri: minimo ordinabile 2 pezzi/multipli.



3



MASCHERA X-PLORE 6300



Maschera panoramica in NEOPRENE di colore nero dotata di attacco filettato standard unificato EN 148-1 per filtri a vite. Doppio bordo di tenuta sul viso, visore in plexiglass ad ampio campo visivo. Munita di diaframma fonico e di parafiamma in materiale composito. Bardatura a 5 tiranti regolabili in lunghezza. Peso gr 570. A norma EN136.

3 RSD999 - maschera X-PLORE 6300

4 RSD51019 - contenitore per maschera a pieno facciale idoneo a contenere maschera + filtro o gruppo erogatore, con tracolla regolabile in materiale plastico flessibile

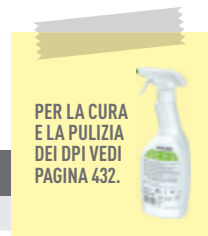

PER LA CURA E LA PULIZIA DEI DPI VEDI PAGINA 432.

FILTRI PER X-PLORE 6300

CODICE	CLASSE
RSD2974	P3
RSD5470	A2 - B2 - E2 - K2 - HG - P3 R D
RSD5812	A1 - B2 - E2 - K1 - HG - CO 20 - NO - P3 R D
RSD5871	A2 - B2 - E2 - K1
RSD5874	A2 - B2 - E2 - K1 - P2 R D
RSD5895	A2 - P3 R D
RSD5896	A2 - B2 - P3 R D
RSD5903	AX - P3 R D
RSD5904	AX
RSD7381	A2
RSD7390	K2 - P2 R D
RSD8856	K2
RSD9182	A2 - B2



Sistemi di protezione delle vie respiratorie ELIPSE

Le maschere Elipse sono tra le più leggere nella loro categoria: grazie alla forma ergonomica, consentono all'operatore un ampio campo visivo e possono essere facilmente indossate con occhiali, elmetti e cuffie. Comfort unico, grazie all'utilizzo di materiali morbidi e inodori derivati da applicazioni medicali.



RESPIRATORE ELIPSE P3 E P3 ANTIODORE POLVERI, ODORI E FUMI



Semimaschera pronta all'uso in TPE (elastomero termoplastico), morbida leggera e compatta, disponibile sia con filtri P3 che con filtri P3 antiodore. Taglia M/L, peso 132 g (maschera + filtri). **Semimaschera a norma EN140:1998. Filtri a norma EN143:2000/A1-P3 (RD).**

- 1** APS501 - semimaschera P3 RD con filtri sostituibili (polveri)
- 2** APS502 - semimaschera P3 RD con filtri sostituibili (antiodore)
- 3** APSF316 - coppia di filtri P3 RD (polveri) di ricambio per APS501
- 3** APSF336 - coppia di filtri P3 RD (antiodore) di ricambio per APS502



RESPIRATORE INTEGRA P3 POLVERI, ODORI E FUMI



Semimaschera compatta, leggera e flessibile: si adatta perfettamente al viso, offrendo una protezione unica e riducendo il rischio di non compatibilità tra DPI, eliminando i problemi di appannamento. Taglia M/L. Visiera antigraffio. **Semimaschera con visiera a norma EN140:1998 e EN166 2.F.K.N. Filtri a norma EN143:2000/A1-P3 (RD) per P3.**

- 5** APS406 - semimaschera P3 RD con filtri sostituibili (polveri)
- 2** APSF316 - coppia di filtri P3 RD (polveri) di ricambio per APS406
- 2** APSP520 - kit 10 pellicole protettive per APS406



RESPIRATORE ELIPSE A1P3 GAS E VAPORI ORGANICI



Semimaschera in TPE (elastomero termoplastico), morbida leggera e compatta. Disponibile nella versione con filtri sostituibili e nella versione senza manutenzione. Taglia M/L, peso 257 g (maschera + filtri). **Semimaschera a norma EN140:1998. Filtri a norma EN14387 (RD). Semimaschera senza manutenzione a norma EN405 (RD).**

- 6** APS503 - semimaschera A1-P3 RD con filtri sostituibili (gas e vapori organici)
- 6** APS504 - semimaschera A1-P3 RD senza manutenzione EN405
- 7** APSF341 - coppia di filtri A1-P3 RD di ricambio per APS503



RESPIRATORE ELIPSE INTEGRA A1P3 GAS E VAPORI ORGANICI



Design flessibile che si adatta al viso, offrendo una protezione unica e riducendo il rischio di non compatibilità tra DPI, eliminando i problemi di appannamento. Taglia M/L, peso 324 g (maschera + filtri). Visiera antigraffio. **Semimaschera con visiera a norma EN140:1998 e EN166 2.F.K.N. Filtri a norma EN14387 per A1-P3 gas e polveri.**

- 8** APS401 - semimaschera A1-P3 RD con filtri sostituibili (vapori organici, polveri, fumi metallici, nebbie, microrganismi)
- 7** APSF341 - coppia di filtri A1-P3 RD di ricambio per APS401



RESPIRATORE ELIPSE A2P3, ABEK1-P3 - GAS E VAPORI ORGANICI E RISCHI COMBINATI



Semimaschera in TPE (elastomero termoplastico) morbida e leggera. Disponibile sia con filtri ABEK1-P3 che con filtri A2-P3. Taglia M/L, peso 340 g (maschera + filtri). **Semimaschera a norma EN140:1998. Filtri a norma EN14387 (RD). Semimaschera senza manutenzione a norma EN405 (RD).**

- 9** APS491 - semimaschera ABEK1-P3 RD con filtri sostituibili (vapori organici, inorganici, ammoniaca, gas acidi, polveri, fumi metallici, nebbie, microrganismi)
- 9** APS496 - semimaschera A2-P3 RD con filtri sostituibili
- 10** APSF492 - coppia di filtri ABEK1-P3 RD di ricambio per semimaschera APS491
- 11** APSF497 - coppia di filtri A2-P3 RD di ricambio per semimaschera APS496





1 RESPIRATORI RIUTILIZZABILI SENZA MANUTENZIONE SERIE 4000+

Semimaschere con filtri integrati pronte all'uso e progettate per una protezione efficace e confortevole da gas, vapori e particolati. Con nuova valvola di espirazione che riduce la resistenza respiratoria di oltre il 30%. Facciale morbida e flessibile, maschera leggera e bilanciata, design ergonomico e di basso profilo per un ottimo campo visivo. Fornite con comodo sacchetto richiudibile per una conservazione pratica e igienica tra un utilizzo e l'altro. A norma EN405:2001+A1:2009. Confezione da 1 respiratore.

AP4251SP - respiratore per vapori organici e polveri. Classe FFA1P2R D

AP4255SP - respiratore per vapori organici e polveri. Classe FFA2P3R D

AP4277SP - respiratore per vapori organici, gas/vapori inorganici, gas/vapori inorganici, gasi acidi e polveri. Classe FFABE1P3R D

AP4279SP - respiratore per vapori organici, gas/vapori inorganici, gas/vapori inorganici, gasi acidi e ammoniaca/metilammina e polveri. Classe FFABEK1P3R D

AP4251PSP - prefiltri per AP4251SP e AP4255SP. Prolungano la durata dei filtri riducendo l'intasamento. Minimo ordinabile 10 pezzi/multipli

i FACCIALI FILTRANTI PER GAS E VAPORI REALIZZATI IN UN UNICO PEZZO, DOTATI DI CONFEZIONE RICHIUDIBILE PER CONSERVARE IL RESPIRATORE IN MODO PRATICO E IGIENICO TRA UN IMPIEGO E L'ALTRO. A NORMA EUROPEA EN405:2001+A1:2009, MUNITI DI VALVOLA DI ESPIRAZIONE PER MIGLIORARE LA RESPIRAZIONE E DI DUE ELEMENTI FILTRANTI A CARBONI ATTIVI. QUANDO I FILTRI SONO ESAURITI, IL RESPIRATORE DEVE ESSERE ELIMINATO: NON SONO QUINDI NECESSARIE PARTI DI RICAMBIO O MANUTENZIONE.

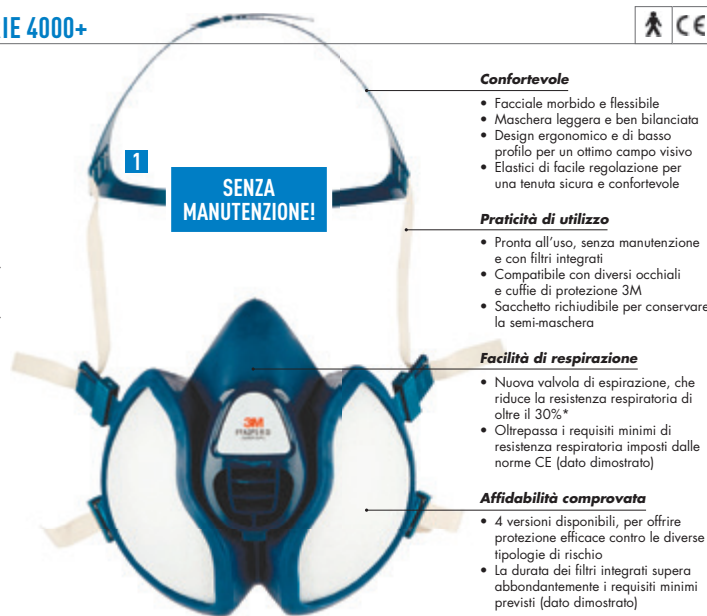

Confortevole

- Facciale morbido e flessibile
- Maschera leggera e ben bilanciata
- Design ergonomico e di basso profilo per un ottimo campo visivo
- Elastici di facile regolazione per una tenuta sicura e confortevole

Praticità di utilizzo

- Pronto all'uso, senza manutenzione e con filtri integrati
- Compatibile con diversi occhiali e cuffie di protezione 3M
- Sacchetto richiudibile per conservare la semi-maschera

Facilità di respirazione

- Nuova valvola di espirazione, che riduce la resistenza respiratoria di oltre il 30%*
- Oltrepassa i requisiti minimi di resistenza respiratoria imposti dalle norme CE (dato dimostrato)

Affidabilità comprovata

- 4 versioni disponibili, per offrire protezione efficace contro le diverse tipologie di rischio
- La durata dei filtri integrati supera abbondantemente i requisiti minimi previsti (dato dimostrato)

2 FILTRI SERIE 6000 PER GAS E VAPORI, PER SEMIMASCHERE E PIENO FACCIALE

Serie 6000 - serie di filtri per gas e vapori che garantiscono la protezione per un ampio spettro di sostanze. Giusto bilanciamento del peso per miglior comfort e del campo visivo. Si abbinano ai filtri e prefiltri antipolvere con gli appositi complementi. Conforme alla norma EN14387:2004. Minimo ordinabile 8 pezzi/multipli (eccetto TF6035 da 20 pezzi/multipli).



3 FILTRI SERIE 2000 E PREFILTRI SERIE 5000 PER SEMIMASCHERE E PIENO FACCIALE

Serie 2000 e serie 5000 - i filtri antipolvere garantiscono protezione sicura e confortevole a persone esposte a polveri, fumi e nebbie. A norma EN143:2000 Minimo ordinabile 20 pezzi/multipli (tranne TF5911 minimo ordinabile 30 pezzi/multipli).



FILTRI SERIE 6000		
CODICE	DESCRIZIONE	NORMA
TF6035	P3R - polveri tossiche, nebbie e fumi	EN143:2000
TF6038	P3R - polveri tossiche, nebbie e fumi + vapori organici e gas acidi sotto il TLV	EN143:2000
TF6051	A1 - vapori organici	EN14387:2004
TF6054	K1 - ammoniaca	EN14387:2004
TF6055	A2 - vapori organici	EN14387:2004
TF6057	ABE1 - vapori organici inorganici gas acidi	EN14387:2004
TF6059	ABEK1 - polivalente combinato	EN14387:2004
TF6075	A1 + Formaldeide	EN14387:2004
TF6096N	AE1 HG P3 - vapori organici, gas acidi, vapori di mercurio, polveri	EN14387:2004 143:2000
TF6098 *	AXP3R - vapori organici punto ebollizione < 65°C + polveri tossiche e nebbie. Fornibili a richiesta	EN14387:2004 143:2000
TF6099N *	ABEK2 HG P3 - polivalente combinato + vapori di mercurio	EN14387:2004 143:2000

* Solo per pieno facciale.

FILTRI SERIE 2000 E PREFILTRI SERIE 5000		
CODICE	DESCRIZIONE	NORMA
TF5911	P1R - polveri nocive e nebbie	EN143:2000
TF5925	P2R - polveri tossiche, nebbie e fumi	EN143:2000
TF5935	P3R - polveri tossiche, nebbie e fumi	EN143:2000
TF2125	P2R - polveri tossiche, nebbie e fumi	EN143:2000
TF2128	P2R - polveri + vapori organici/gas acidi <al TLV	EN143:2000
TF2135	P3R - polveri tossiche, nebbie e fumi	EN143:2000
TF2138	P3R - polveri + vapori organici/gas acidi <al TLV	EN143:2000

COMPLEMENTI PER SEMIMASCHERE E PIENO FACCIALE

COMPLEMENTI PER UTILIZZO FILTRI	
CODICE	DESCRIZIONE
4 TM0501	Ghiera - per i filtri serie 6000 e prefiltri serie 59..
5 TM0502	Adattatore - per i filtri serie 6000 e 2000
6 TM0603	Piattaforma - solo con filtri serie 59..

SCHEMA PER L'UTILIZZO DEI FILTRI

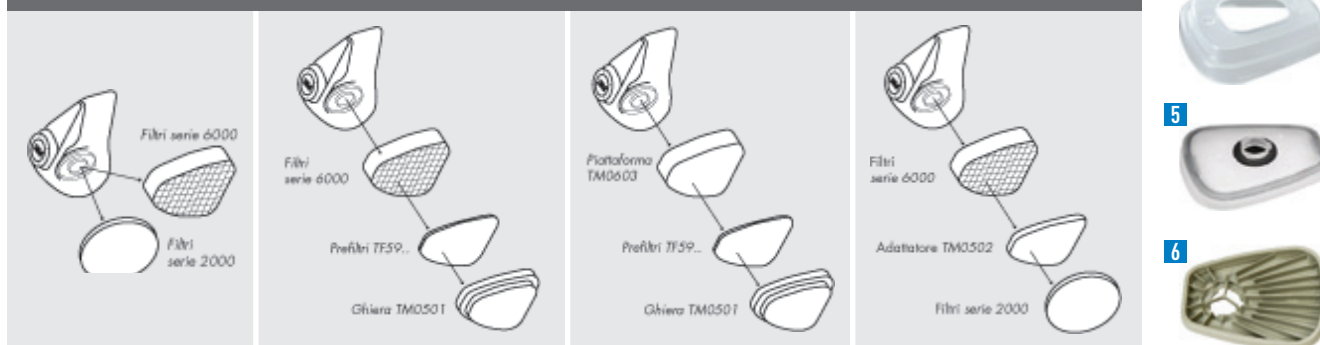



1

LEGGERA,
MASSIMO
COMFORT



2

ECONOMICA,
MANUTENZIONE
MINIMA



COMFORT
E DURATA



1 MASCHERA SERIE 6000



Maschera pieno facciale in materiale termoplastico, utilizzabile con filtri della serie 6000, 5000 e 2000, con innesto a baionetta a garanzia di una bilanciatura ottimale. Ampio campo visivo, leggera, facile da indossare, minima manutenzione, rapporto prezzo/qualità molto favorevole. Disponibile in due taglie, fornibile a richiesta la taglia piccola. A norma EN136:1998 - classe I.

TM6800S - maschera serie 6000, taglia M

TM6900S - maschera serie 6000, taglia L

2 SEMIMASCHERA SERIE 6000



Semimaschera in materiale elastomerico confortevole da indossare, grazie ad un soffice e ipoallergenico facciale e a una valvola di espirazione centrale. Semplice da utilizzare, richiede una manutenzione minima e rappresenta una scelta economica. A norma EN140:1998.

TM6200 - semimaschera serie 6000, taglia M

TM6300 - semimaschera serie 6000, taglia L

5 SEMIMASCHERA SERIE 7500



Semimaschera serie 7500 in gomma silicica con bardatura elastica bilanciata e morbido facciale, ampia valvola a bassa resistenza respiratoria. Fornibile nelle taglie media e grande. A norma EN140:1998.

TM7502 - semimaschera serie 7500, taglia M

TM7503 - semimaschera serie 7500, taglia L



4

RIUTILIZZABILE,
PERFETTA ADERENZA,
MASSIMO COMFORT



5

SISTEMA DROP DOWN

NEW

4 SEMIMASCHERA 6500QL



Semimaschera in silicone con sistema di aggancio/sgancio rapido **Quick Latch** che permette di indossare/togliere facilmente il respiratore. Calotta nucale con 3 regolazioni. Sistema a baionetta flessibile per attacco a un'ampia serie di filtri 3M per gas, vapori e antiparticolato. Valvola di espirazione **Cool Flow**, maggiore comfort grazie alla riduzione di calore e umidità. A norma EN 140:1998.

TM6501 - semimaschera serie 6500QL, taglia S

TM6502 - semimaschera serie 6500QL, taglia M

TM6503 - semimaschera serie 6500QL, taglia L

5 SEMIMASCHERA HM500



Semimaschera morbida, leggera e resistente, tenuta efficace, facile utilizzo. Grazie al materiale morbido, il comfort è garantito anche in caso di uso prolungato. **Il sistema drop-down consente ai lavoratori di indossare la semimaschera senza rimuovere gli altri DPI (elmetto, cuffie, occhiali).** Priva di lattice (anallergica) può essere utilizzata in operazioni in cui il silicone non è accettabile (ad es. verniciatura a spruzzo). Settori di utilizzo: farmaceutico, processi chimici, verniciatura, saldatura, edilizia. Facile aggancio con filtri a baionetta (non inclusi, da ordinare separatamente).

PHM500 - semimaschera bifiltro colore grigio, taglia M

PFHM500 - confezione da 4 filtri P3 per semimaschera HM500

6 KIT SEMIMASCHERA CON FILTRI



Kit composto da semimaschera in gomma TPE e polipropilene autoestinguenti sovrastampati, di taglia universale, dotata di due raccordi rapidi a baionetta con 2 filtri. **Il kit con filtri A1+P2 R è ideale per la verniciatura a spruzzo** in genere o altre applicazioni con vapori organici più particelle e aerosol di media tossicità, con granulometria uguale o superiore a 0,6 micron. Filtra il 94% di particelle solide e liquide. Limite di impiego: 12 x TLV. **Il kit con filtri ABEK1P3 R è ideale per trattamenti fitosanitari** in genere, con particelle e aerosol tossici, con granulometria uguale o superiore a 0,3 micron. Filtra il 99% di particelle solide e liquide. Limite di impiego: 50 x TLV.

APM2012 - kit semimaschera con filtri **A1+P2 R**

APM2013 - filtro di ricambio **A1+P2 R** (minimo ordinabile 4 pezzi/multipli)

APM2043 - kit semimaschera con filtri **ABEK1P3 R**

APM2044 - filtro di ricambio **A1B1E1K1 P3 R** (minimo ordinabile 4 pezzi/multipli)

SEMIMASCHERA A DOPPIO RACCORDO CON ATTACCO RAPIDO, FORNITA IN PRATICO BLISTER.



6



Maschere a pieno facciale



GUARDA IL VIDEO!



1 MASCHERA C701



Maschera a pieno facciale dal design ergonomico, leggera, semplice manutenzione. L'innovativo sistema di ispirazione dell'aria Air-On (con valvola di ispirazione rettangolare e assenza delle valvole di non-ritorno), consente allo schermo di non appannarsi, garantendo un livello minimo di resistenza respiratoria. Bardatura a 5 tiranti intercambiabile in EPDM. Visore in classe ottica 1 consente un ampio campo visivo senza distorsioni e aberrazioni. Attacco filtro universale, può essere impiegata con filtri antipolvere, antigas e combinati offrendo un'elevata protezione da gas, vapori e particolati. Certificata classe 3 (EN136). Colore rosso (a richiesta fornibile in altri colori).

PC5000 - maschera C701, bardatura in EPDM, peso 620 gr

MASCHERA C607 E



Maschera a pieno facciale taglia universale, per l'impiego diretto con filtri della **serie DIRIN 230** e **DIRIN 500** e tramite raccordo **PM3220** con filtri della **serie 230**. Raccordo filettato EN148/1. Schermo in policarbonato antigraffio, resistente agli urti, alla fiamma ed al calore. Peso gr 580 circa. A norma EN136 - classe II. Fornite senza filtro.

2 PC2025 - maschera C607 E in gomma silconica gialla

3 PC2007 - maschera C607E in EPDM

PC2030 - maschera in EPDM identica alla PC2007, **senza membrana fonica**

4 MASCHERA C607 TWIN



Maschera in EPDM, taglia universale, con 2 raccordi filettati per filtri **serie 200**. Schermo panoramico in polimetacrilato, gruppo valvolare di espirazione con precamera compensatrice, dispositivo fonico, bardatura elastica a 5 tiranti con fibbie di regolazione. A norma EN136 - classe II. **Fornita senza filtro.**

PC0608 - maschera C607 TWIN, peso gr 580 circa



AMPIO VISORE PANORAMICO

MASCHERA IDEA



Maschera in EPDM o gomma silconica con **ampio visore panoramico**, taglia universale per l'impiego diretto con filtri serie **DIRIN 230** e **DIRIN 500** e tramite raccordo (PM3220) con filtri serie **230**. Raccordo filettato EN 148/1. Ottima trasmissione della voce, schermo in policarbonato antiacido, antigraffio, privo di distorsioni. Tracolla di sostegno. Peso 665 gr. A norma EN136 - classe III. **Fornite senza filtro.**

5 PC4006 - maschera IDEA in EPDM colore nero

6 PC4009 - maschera IDEA in gomma silconica gialla



MASCHERA SFERA



Maschera in EPDM o gomma silconica, taglia universale, per l'impiego diretto con filtri della **serie DIRIN 230** e **DIRIN 500** e tramite raccordo **PM3220** con filtri della **serie 230**. Raccordo filettato EN 148/1. Ampio campo visivo, ottima trasmissione della voce, schermo antigraffio, resistente agli urti, alla fiamma ed al calore. Tracolla di sostegno. Peso gr 650 circa. A norma EN136 - classe III. **Fornite senza filtro.**

7 PC3005 - maschera SFERA in EPDM colore nero

8 PC3002 - maschera SFERA in gomma silconica colore giallo





Accessori per maschere a pieno facciale



1

1 PELLICOLE PER MASCHERE

Kit di 10 pellicole per la protezione dello schermo delle maschere a pieno facciale.
PC5027 - pellicole per maschere C701
PC5146 - pellicole per maschere C607



2



3

MONTATURE PER LENTI CORRETTIVE

Montature per maschere a pieno facciale.
2 PC1225 - montatura per maschera C607 E
3 PC1100 - montatura per maschera Sfera
4 PC1203 - montatura per maschera Idea

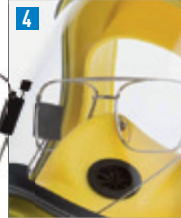

4



5

6

BORSE CUSTODIA PER MASCHERE

Borse custodia per maschere in resina sintetica.
5 PC9020 - custodia per maschere Sfera e Idea
6 PC9010 - custodia per maschere C607E e C607 Twin

Semimaschere



7



8



9



10

POLIMASK® 2000 ALFA



Semimaschera di taglia universale in EPDM (gomma sintetica) o silicone, per l'impiego con filtri della **serie DIRIN 230** o tramite raccordo con filtri della **serie 230**. Con raccordo filettato EN 148/1 e bardatura a doppio tirante con armatura anteriore per un ottimale trasferimento della trazione sulla parte in gomma o silicone permettendo una tenuta senza incertezze. **Fornita senza filtri.** Peso gr 160 circa. A norma EN140.

- 7 PM2107** - semimaschera in EPDM nera
- 8 PM2108** - semimaschera in gomma gialla siliconica
- PM3220** - raccordo per filtri serie 230

POLIMASK® 2000 GAMMA



Semimaschera di taglia universale disponibile in EPDM (gomma sintetica) o silicone. Dotata di raccordo filettato per un filtro della **serie 230**. Bardatura a doppio tirante con armatura anteriore per un ottimale trasferimento della trazione sulla parte in gomma o silicone, permettendo una tenuta senza incertezze. **Fornita senza filtri.** Peso gr 160 circa. A norma EN140.

- 9 PM2112** - semimaschera in EPDM nera
- 10 PM2113** - semimaschera in gomma gialla siliconica



11



12



13



14

POLIMASK® 2000 BETA



Semimaschera taglia universale in EPDM (gomma sintetica) o silicone. Con 2 raccordi filettati speciali per filtri **serie 200**. Bardatura a doppio tirante con armatura anteriore per un ottimale trasferimento della trazione sulla parte in gomma o silicone permettendo una tenuta senza incertezze. **Fornita senza filtri.** Peso gr 150 circa. A norma EN140.

- 11 PM2109** - semimaschera in EPDM nera
- 12 PM2111** - semimaschera in gomma gialla siliconica

POLIMASK® 230



Semimaschera di taglia universale in EPDM o gomma siliconica, con raccordo filettato per un filtro della **serie 230**. Bardatura anatomica a due tiranti di cui il superiore sdoppiato, con passanti di regolazione incorporati nelle fibbie. **Fornita senza filtri.** Peso gr 160 circa. A norma EN140.

- 13 PM2100** - semimaschera in EPDM nera
- 14 PM2105** - semimaschera in gomma gialla siliconica





Filtri per maschere e semimaschere



UTILIZZABILI CON LE MASCHERE 2000 ALFA - C607E SFERA - IDEA

1 FILTRI SERIE DIRIN 230



Filtri con involucro in resina sintetica ed attacco filettato EN148/1. Vedi classi, omologazioni e applicazioni nella tabella sotto riportata. Conformi alla norma EN14387:2004 (PF0590 a norma EN143:2000).

FILTRI SERIE DIRIN 230

CODICE	CLASSE	PROTEZIONE DA
PF0590	P3	Polveri, fumi, nebbie, radionucleidi
PF0600	A2	Vapori organici
PF0601	B2	Vapori inorganici
PF0602	E2	Gas acidi
PF0603	K2	Ammoniaca
PF0604	AX	Vapori organici basso bollenti
PF0619	A2 - B2	Vapori organici e inorganici
PF0620	A2 - P2	Vapori organici, polveri, fumi, nebbie
PF0623	K2 - B2	Ammoniaca, polveri, fumi, nebbie
PF0625	A2 - P3	Vapori organici, polveri, fumi, nebbie
PF0626	B2 - P3	Vapori inorganici, polveri, fumi, nebbie
PF0627	A2 - B2 - P3	Vapori organici e inorganici, polveri, fumi, nebbie
PF0628	E2 - P3	Gas acidi, polveri, fumi, nebbie
PF0638	A2 - B2 - E2 - K2	Polivalente
PF0640	A2 - B2 - E2 - K2 - P3	Polivalente combinato
PF0654	A2 - B2 - E2 - K2 - HG - P3	Polivalente combinato, vapori di mercurio



UTILIZZABILI CON LE MASCHERE C607E - SFERA - IDEA

2 FILTRI SERIE DIRIN 500/530



Filtri con involucro in lega leggera e attacco filettato EN148/1. Vedi classi, omologazioni e applicazioni nella tabella sotto riportata. Conformi alla norma EN14387:2004.

FILTRI SERIE DIRIN 500/530

CODICE	CLASSE	PROTEZIONE DA
PF1701	A2	Vapori organici
PF1702	B2	Vapori inorganici
PF1703	E2	Gas acidi
PF1704	K2	Ammoniaca
PF1710	A2 - P3	Vapori organici, polveri, fumi, nebbie
PF1711	B2 - P3	Vapori inorganici, polveri, fumi, nebbie
PF1713	K2 - P3	Ammoniaca, polveri, fumi, nebbie
PF1885	A2 - B2 - E2 - K2 - HgNO2COP3	Polivalente combinato, monossido di carbonio
PF1887	A2 - B2 - E2 - K2 - P3	Polivalente combinato
PF1894	A2 - B2 - E2 - K2 - HG - P3	Polivalente combinato



UTILIZZABILI CON LE MASCHERE 2000 BETA - C607 TWIN

3 FILTRI SERIE 200



Filtri con involucro in resina sintetica. Vedi classi, omologazioni e applicazioni nella tabella sotto riportata. A norma EN14387:2004 (PF1006 e PF1007 a norma EN143:2000).

FILTRI SERIE 200

CODICE	CLASSE	PROTEZIONE DA
PF1001	A1	Vapori organici
PF1002	B1	Vapori inorganici
PF1003	E1	Gas acidi
PF1004	K1	Ammoniaca
PF1006	P2	Polveri, fumi, nebbie
PF1007	P3	Polveri, fumi, nebbie, radionucleidi
PF1012	A1 - P3	Vapori organici, polveri, fumi, nebbie
PF1013	B1 - P3	Vapori inorganici, polveri, fumi, nebbie
PF1014	E1 - P3	Gas acidi, polveri, fumi, nebbie
PF1015	K1 - P3	Ammoniaca, polveri, fumi, nebbie
PF1021	A1 - B1 - E1 - K1 - P3	Polivalente combinato
PF3215	A1 - P1	Esteri fosforici, vernici a spruzzo
PF3216	A1 - B1	Vapori organici e inorganici



UTILIZZABILI DIRETTAMENTE CON LE MASCHERE 2000 GAMMA - POLIMASK 230

UTILIZZABILI TRAMITE RACCORDO CON LE MASCHERE 2000 ALFA - C607E - SFERA - IDEA

4 FILTRI SERIE 230



Filtri con involucro in ABS. Vedi classi, omologazioni e applicazioni nella tabella sotto riportata. A norma EN14387:2004 (PF5116 e PF5117 a norma EN143:2000).

FILTRI SERIE 230

CODICE	CLASSE	PROTEZIONE DA
PF5100	A1	Vapori organici
PF5101	B1	Vapori inorganici
PF5102	E1	Gas acidi
PF5103	K1	Ammoniaca
PF5105	A2	Vapori organici
PF5106	A2 - P2	Vapori organici, polveri, fumi, nebbie
PF5108	E2 - P2	Gas acidi, polveri, fumi, nebbie
PF5109	K2 - P2	Ammoniaca, polveri, fumi, nebbie
PF5113	B2	Vapori inorganici
PF5115	K2	Ammoniaca
PF5116	P2	Polveri, fumi, nebbie
PF5117	P3	Polveri, fumi, nebbie, radionucleidi
PF5120	A2 - P3	Vapori organici, polveri, fumi, nebbie
PF5121	B2 - P3	Vapori inorganici, polveri, fumi, nebbie
PF5123	A2 - B2 - E2 - K1 - P3	Polivalente combinato
PF5125	A1 - B1	Vapori organici e inorganici
PF5127	A1 - P1	Esteri fosforici, vernici a spruzzo



Dispositivi di fuga



1 DISPOSITIVO DI FUGA POLIBLITZ ABEK15



Con filtro ABEK, 4 anni di stoccaggio. Protegge da gas o vapori tossici per 15 minuti in caso di fuga o emergenza (secondo la norma DIN58647-7). Non offre protezioni da polveri o fumi né da monossido di carbonio. Fornito completo di contenitore in resina polimerica rossa. Peso: 410 gr circa con custodia. A norma DIN 58647-7.

PM0230 - respiratore POLIBLITZ con filtro ABEK

PM0240 - kit ricambio (filtro e nastro adesivo)

2 DISPOSITIVO DI FUGA BLITZ 5



Dispositivo di fuga monouso a filtro con boccaglio e stringinaso, **copertura di 5 minuti e 6 anni di stoccaggio**. Apertura semplice e veloce. Non protegge da monossido di carbonio o da carenze di ossigeno. Utilizzo istintivo che rende immediato l'isolamento dall'ambiente inquinato circostante. Pratica custodia rigida in PP che può essere tenuta in tasca o fissata comodamente alla cintura. Involucro filtro in ABS, boccaglio in silicone. Il filtro non è sostituibile. A norma DIN 58647-7.

PM0369 - dispositivo di fuga BLITZ 5 con filtro ABEK, peso 165 gr con custodia

3 DISPOSITIVO DI FUGA SEKUR ESCAPE



Dispositivo di fuga monouso, **con filtro per proteggere dalle sostanze che normalmente si liberano durante un incendio. Copertura di 15 minuti e 6 anni di stoccaggio**. Cappuccio in sottile film poliimmidico altamente resistente al calore, alle temperature elevate e alla fiamma. La colorazione giallo-ambra migliora la visibilità dell'utilizzatore in ambienti in cui c'è presenza di fumo, mantenendo il campo visivo completo senza aberrazioni né distorsioni. Resistente alla fiamma e all'impatto; provvisto di boccaglio e stringinaso; indicato contro polveri, gas e vapori che si sprigionano più frequentemente durante un incendio (monossido di carbonio (CO), Acroleina, HCl, HCN, e da polveri in classe P2). A norma EN403.

PM0300 - dispositivo Sekur Escape

4 DISPOSITIVO DI FUGA A FILTRO ESCABEK



Dispositivo di fuga monouso con filtro ABEK P 15 e P 3 15, dotato di boccaglio e cappuccio. Protegge da gas, vapori e polveri. Non offre protezioni da monossido di carbonio. **Studiato appositamente per l'evacuazione di siti industriali in caso di contaminazione da agenti chimici**. Offre una **copertura di 15 minuti e 6 anni di stoccaggio**. Il cappuccio, resistente e trasparente, mantiene inalterato il campo visivo naturale. Tutti gli altri materiale che compongono il dispositivo sono resistenti a fiamma e calore, con elevata resistenza all'impatto. Apertura semplice e veloce: si indossa il boccaglio e lo stringinaso, quindi si calza il cappuccio regolando il laccio sul collo. A norma DIN 58647-7.

PM0305 - dispositivo di fuga escABEK P15

PM3305 - dispositivo di fuga escABEK P 3 15 (certificazione aggiuntiva in conformità alla direttiva EN 14387, classe A1B1E1K1 P3)



5 DISPOSITIVO DI FUGA SEKUR NAVY CAP



Autorespiratore a cappuccio a flusso costante per la fuga in presenza di sostanze tossiche o carenza di ossigeno. Copertura di 15 minuti. Per l'uso basta aprire la borsa di trasporto, indossare il cappuccio e fuggire. Bombola in acciaio da 3.0 litri a 200 bar CEE; segnalatore acustico che entra in funzione quando la riserva d'aria si avvicina all'esaurimento. Conforme alla Direttiva DPI 89/686/CEE e successive modifiche ed alla norma nazionale che recepisce la norma armonizzata EN 1146 e ISO 23269-1. È inoltre conforme alla Direttiva MED 2014/90/UE e alla Direttiva PED 2014/68/UE.

PM0282 - dispositivo di fuga Sekur Navy Cap



6 AUTORESPIRATORE INDUSTRIAL DIABLO



Modello per il mondo industriale. Zaino realizzato con piastra anatomica in resina sintetica autoestinguenta; bardatura prodotta con struttura composita di filato autoestinguenta, gli spillacci imbottiti alloggiati al loro interno le tubazioni di alta e media pressione proteggendole così dal fuoco e dalle abrasioni, riduttore di pressione C2000 (brevettato), di tipo compensato, sfrutta un principio di compensazione attiva della spinta per la chiusura della valvola principale; manometro posizionato sul lato sinistro dell'operatore ancorato allo spillaccio e connesso al riduttore tramite una frusta di alta pressione; segnalatore acustico direttamente montato sul corpo riduttore; erogatore E400 AP/A di tipo autopositivo (resta in standby fino al momento della prima respirazione). Conforme alla norma europea EN 137.

PC5126 - autorespiratore DIABLO C 607 SP/A, senza innesto rapido, con bombola in acciaio da 6 litri a 300 bar DIN





1 SEMIMASCHERA FIT MASK 87 A DOPPIO FILTRO

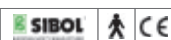

Nastro elastico in poliestere e gomma, bardatura nucale con quattro punti di attacco per una maggior aderenza al volto. La presenza della valvola di espirazione agevola la respirazione. Il prefiltro P2 (RSS123) può essere aggiunto o rimosso su qualsiasi filtro in base alle necessità o all'usura. A norma: EN 140:1998. Peso circa 135 gr. Compatibile con filtri RSS025, RSS011, RSS123, RSS31.

PCS87 - semimaschera in TPE a doppio filtro

FILTRI E PREFILTRO PER FIT MASK 87

CODICE	CLASSE	PROTEZIONE DA
RSS025	A1 B1 E1 K1	polivalente
RSS011	A2	vapori organici
RSS123	P2	polveri, fumi
RSS311	A2 P3 NR	vapori organici, polveri, fumi

2 SEMIMASCHERA ST85



In gomma stampata a filtro singolo. Ideale per manipolazione di sostanze chimiche nocive, gas tossici, solventi e polveri. Nastro elasticizzato, raccordo filettato EN 148/1. A norma: EN 140:1998. Compatibile con filtri RSS415, RSS442, RSS453.

PCS85 - semimaschera a filtro singolo, peso 120 gr circa

3 MASCHERA INTERA TR82



Maschere intera a pressione negativa con raccordo filettato EN 148-1. Peso circa 650 g.

PCS112 - maschera intera a norma EN 136:1998 Classe III

4 MASCHERA TR 2002 CL2



Maschera intera a pressione negativa con raccordo filettato EN 148-1. Costituita da facciale in TPE, schermo in policarbonato, mascherina interna in TPE, testiera in EPDM a cinque bracci. Può essere utilizzata con dispositivi a depressione dotati dello stesso raccordo filettato EN148-1. Con dispositivo fonico, peso 580 g circa. A norma EN 136:1998 Classe II. Compatibile con filtri RSS415, RSS442, RSS453.

PCS202 - maschera intera in TPE a filtro singolo

FILTRI E PREFILTRO PER TR2002 E TR82

CODICE	CLASSE	PROTEZIONE DA
RSS442	A2 P3	vapori organici, polveri, fumi
RSS415	P3 R	polveri, fumi
RSS453*	A2 B2 E2 K2 P3 R D	polivalente combinato

* Montabile su semimaschere con raccordo EN 148-1 (PCS85), peso < 300 gr



5 RESPIRATORE D'EMERGENZA H900



Cappuccio di fuga per auto salvataggio. Facile impiego, consente di allontanarsi con rapidità dall'area inquinata in caso di incendio. Con filtro per acroleina, cloruro di idrogeno, cianuro di idrogeno, monossido di carbonio, polveri, fumi, nebbie. Il respiratore è contenuto in una pratica borsa in tessuto antistatico con passanti per cintura, anello per applicazione a parete e anelli laterali per l'uso a tracolla. Peso circa 550 g. Cappuccio filtrante antifumo di tipo CO P classe 15 minuti, di tipo M (mobile) secondo la norma EN 403:2004. A richiesta fornibile varia gamma di filtraggio.

PCS171 - respiratore d'emergenza H900 CO P



6 AUTORESPIRATORE DI FUGA (EEBD) SK 1203



Autorespiratore ad aria compressa a circuito aperto con cappuccio per la fuga composto da una bombola, da una valvola/riduttore di pressione, da un tubetto di respirazione, da un cappuccio e da una sacca di contenimento. Ideale per ambienti con presenza di fumi di incendio o mancanza di ossigeno. Peso circa 6 kg. Fornisce all'utilizzatore aria respirabile a flusso continuo per più di 15 minuti. A norma: EN 1146:2006 e ISO 23269-1:2008 Classe 15 minuti.

PCS403 - autorespiratore di fuga SK 1203



7 RESPIRATORE D'EMERGENZA M900 ABEK P 15



Dispositivo di fuga di facile impiego che consente di allontanarsi con la massima rapidità dall'area inquinata in caso di incidente. Fornito in una pratica custodia in plastica con clip per aggancio alla cintura. Peso circa 306 g. Dispositivo filtrante per auto salvataggio contro gas e polveri ABEK P, classe 15 minuti. A norma DIN 58647-7:1997.

PCS117 - respiratore d'emergenza M900



Spazi confinati DPR n. 177/2011

Per spazio confinato non si intende esclusivamente un ambiente ristretto e angusto ma si intendono anche ambienti in cui la presenza di ossigeno è ridotta, luoghi dai quali non è possibile allontanarsi velocemente e comunque dove la ventilazione può cambiare repentinamente modificando la concentrazione dei tossici presenti nell'ambiente (ad esempio silos, cisterne, pozzi, reti fognarie ecc). **Il Decreto DPR n. 177/2011** sottolinea l'importanza della formazione preventiva e in particolare sancisce che, per avere la qualificazione ad operare in tali condizioni è necessario il possesso di Dispositivo di Protezione Individuale, strumentazione e attrezzature di lavoro idonei.

RESPIRATORI PER L'UTILIZZO IN SPAZI CONFINATI COME:

- ◆ SERBATOI, CISTERNE, SILOS, POZZI, GASDOTTI, RETI FOGNARIE ECC.
- ◆ LUOGHI ANGUSTI CON SCARSA PRESENZA DI OSSIGENO
- ◆ LUOGHI DOVE LA VENTILAZIONE PUÒ CAMBIARE REPENTINAMENTE MODIFICANDO LA CONCENTRAZIONE DEI TOSSICI PRESENTI NELL'AMBIENTE
- ◆ LUOGHI DAI QUALI SIA COMUNQUE POSSIBILE PRELEVARE DALL'AMBIENTE CIRCOSTANTE ARIA NON CONTAMINATA SENZA ADDUZIONE DI ARIA COMPRESSA



RESPIRATORI ISOLANTI AD ARIA FRESCA DUCT ECO / DUCT A ECO



Disponibile in due versioni con principio di funzionamento identico: l'aria viene prelevata al di fuori dell'area contaminata per mezzo di un tubo corrugato. Di semplice utilizzo, facile e intuitivo, ideale per utilizzatori non altamente specializzati. Costituito da un **imbragatura** dotata di cintura regolabile, spallaccio con fascetta in velcro per mantenere il tubo corrugato in posizione. Il **collettore**, situato alla cintura, collega il tubo corrugato e il tubo di alimentazione. Nella versione assistita il collettore è dotato di valvola di sovrafflusso. **Tubo di respirazione** provvisto di raccordo a filettatura standard secondo EN 148/1 per la parte che si collega alla maschera intera, e **tubo di alimentazione** da 10 m. Un raccordo a baionetta permette di collegare gli spezzoni in modo da poter raggiungere la lunghezza necessaria. Per la versione DUCT ECO (non assistita) la lunghezza massima è di 20 m. La parte terminale del tubo è dotata di un filtro il cui scopo è di prevenire la penetrazione accidentale di corpuscoli esterni come polveri, granelli, ecc.. Nella versione DUCT A ECO (assistita) la lunghezza può arrivare fino a 60 m quando utilizzato da un operatore, oppure 30 m quando utilizzato da due operatori simultaneamente. Facile trasporto grazie al contenitore in materiale plastico. **Conforme alla norma UNI EN 138:1994.**

- 1 PCS202** - maschera a pieno facciale TR 2002 CL2
 - 2 PCS1401** - respiratore DUCT A ECO ad aria fresca **assistito** (respirazione facilitata da un ventilatore elettrico - flusso d'aria regolabile). Per un operatore, con 10 m di tubo, senza maschera
 - 3 PCS1400** - respiratore DUCT ECO ad aria fresca **non assistito** (si utilizza la sola forza dei polmoni). Per un operatore, con 10 m di tubo, senza maschera
- PCS14012** - spezzone tubo alimentazione da 10 m



SET RESPIRATORE TURBINE



Gamma di dispositivi di protezione delle vie respiratorie alimentati da elettroventilatore. Sono dotati di batteria ricaricabile e sono da utilizzarsi in combinazione con due filtri antipolvere o combinati. Sostituiscono i dispositivi filtranti tradizionali costituiti da facciale più filtro in lavori gravosi e prolungati perché il flusso d'aria immesso elimina lo sforzo respiratorio. Sono adatti per lavori quali bonifica da amianto, lavorazioni in ambienti polverosi e irrorazione di prodotti chimici per agricoltura. Oltre a TURBINE TM 1702 (maschera pieno facciale) già da tempo presente sul mercato, la gamma è stata ampliata con tre nuovi modelli: TURBINE CFU (casco con visiera), TURBINE FU (visiera leggera) e TURBINE H (cappuccio in Tyvek F®). I respiratori TURBINE sono concepiti per proteggere l'operatore garantendo un alto grado di comfort grazie:

- al flusso ideale in maschera che annulla lo sforzo respiratorio dell'operatore e non dà fastidio al viso
- allo schienalino ergonomico imbottito applicato in cintura
- al peso decisamente contenuto rapportato all'autonomia offerta

Sono progettati per poter essere utilizzati durante decontaminazione tramite doccia.

- 4 PCS388** - set Turbine H cappuccio Tyvek F, a norma EN12941:2009 classe TH2P
 - 5 PCS381** - set Turbine TM1702 2, a norma EN12942:2009 classe TM3
 - 6 PCS386** - set Turbine CFU casco con visiera, a norma EN12941:2009 classe TH2P
 - 7 PCS387** - set Turbine FU visiera leggera, a norma EN12941:2009 classe TH2P
 - 8 PCS911** - cintura PVC 45 per Turbine H, Turbine CFU e Turbine FU
- PCS361** - carica batterie 1000 mAh -Turbine 170
RSS415 - filtro 100 P3 R
PCS332 - filtro 202 A2B2P3 R D
PCS335 - filtro 202 A2B2E2P3 R D



1 AUTORESPIRATORE PSS3000 FIXED LDV PER DOTAZIONI DI EMERGENZA



Autorespiratore a sovrappressione con schienale antistatico rinforzato in fibra di carbonio, fascetta stringibombola universale. Bardature smontabili e lavabili senza l'ausilio di attrezzi; pneumatica serie PSS con connessioni snodate; erogatore bilanciato in sovrappressione serie PSS **collegato direttamente al primo stadio**. Bombola in acciaio 7 litri 200 bar con valvola DIN200 montata e carica di aria respirabile pronta all'impiego. Maschera a pieno facciale in EPDM con attacco unificato M45x3 UNI-EN 148-3, diaframma fonico in materiale composito e paraflamma in acciaio inox. **A norma EN137 classe 2. Certificazione MED & SOLAS (specifica per l'equipaggiamento marittimo).**

RSD685 - autorespiratore con bombola 7 litri 200 bar (durata stimata 35 minuti), dotata di valvola con attacco DIN G5/8" (fornita carica e pronta all'uso), maschera a pieno facciale

2 AUTORESPIRATORE PSS3000 QRC PER DOTAZIONI PROFESSIONALI



Autorespiratore professionale a sovrappressione con schienale antistatico rinforzato in fibra di carbonio, fascetta stringibombola universale. Bardature smontabili e lavabili senza l'ausilio di attrezzi; pneumatica serie PSS con connessioni snodate; erogatore bilanciato in sovrappressione serie PSS **staccabile con aggancio rapido**. Bombola in acciaio 7 litri 200 bar con valvola DIN200 montata e carica di aria respirabile pronta all'impiego. Maschera a pieno facciale in EPDM con attacco unificato M45x3 UNI-EN 148-3, diaframma fonico in materiale composito e di paraflamma in acciaio inox. **A norma EN137 classe 2. Certificazione MED & SOLAS (specifica per l'equipaggiamento marittimo).**

RSD913 - autorespiratore con bombola 7 litri 200 bar (durata stimata 35 minuti), dotata di valvola con attacco DIN G5/8" (fornita carica e pronta all'uso), maschera a pieno facciale



3 AUTORESPIRATORE "COLT" PER SPAZI CONFINATI



Sistema di fuga a breve durata di facile impiego, leggero ed ergonomico. Bombola da posizionare al fianco con un sistema di bardatura sofisticato che lo trattiene in posizione garantendo comfort e rapido ed agevole indossamento. Bardatura in materiale antistatico resistente agli agenti chimici e sollecitazioni meccaniche, la particolare flessibilità dei materiali consente alla bardatura di modellarsi sul corpo dell'utilizzatore. **A norma EN137 ed EN136 classe 3 per la maschera.**

RSD634 - sistema per spazi confinati PAS Colt, base con alloggiamento per bombola lt 3 200 bar (durata stimata 15 minuti)



4 COMPRESSORE PORTATILE BAC100



Per la ricarica di bombole ad aria compressa respirabile ad alta pressione. Raffreddato ad aria, dotato di due uscite con attacco intenzionale DIN G5/8" di cui una a 225 bar e una a 330 bar. Telaio portante in acciaio inossidabile. Portata 100 litri/minuto. Dimensioni: cm 65 x 39 x 40.

RSD646 - compressore BAC100 PN 225/330 bar/230V/50Hz 1 fase

RSD786 - spegnimento automatico al raggiungimento pressione di carica e contatore ore di lavoro

RSD788 - drenaggio automatico condensa per motore 1 fase

RSD789 - telaio di supporto con ruote



SUGLI AUTORESPIRATORI ACQUISTATI SI ESEGUONO INTERVENTI DI MANUTENZIONE E REVISIONE PERIODICA (PREVENTIVI A RICHIESTA).



1 DISPOSITIVO DI FUGA PARAT 1200



Dispositivo di fuga estremamente compatto, con boccaglio/stringinaso e filtro multigas ABEK, che assicura 10 minuti di protezione contro gas e vapori industriali tossici. Custodia semitrasparente con sigillo antimano-missione, clip integrata per aggancio a cintura o indumenti da lavoro. A norma DIN 58647-7. Peso 210 g circa, dimensioni 115 x 95 x 70 mm.

RSD2149 - dispositivo di fuga Parat 1200 (durata 4 anni)

RSD2150 - dispositivo di fuga Parat 1260 (durata 6 anni)



SISTEMI DI FUGA PARAT 3000



Proteggono le vie respiratorie per almeno 15 minuti, assicurando la via di fuga dalla zona contaminata dai gas e vapori. Facili da usare anche per personale non addestrato. Classe protettiva contro gas e vapori: ABEK. Custodia in materiale antifuoco con clip per il fissaggio a cintura (A). Disponibile in due versioni: a semimaschera e con boccaglio. Omologazione CE conseguita per conformità alla specifica tecnica DIN 58647-7.

2 RSD311 - semimaschera con filtro ABEK, peso gr 360. Durata minima: 15 minuti

3 RSD312 - boccaglio con tappanaso e filtro ABEK, peso gr 330. Durata minima: 15 minuti

RSD350 - filtro di ricambio ABEK per serie PARAT 3000



Cappuccio ben visibile

Imbragatura elastica interna

Forma ergonomica

Perfetta visibilità

Filtro ad alte prestazioni

Collarino flessibile

Valvola di espirazione



CAPPUCCIO DI FUGA PARAT 5500



Assicura 15 minuti di protezione effettiva da gas tossici, polveri e vapori presenti nell'aria, filtrando anche il "monossido di carbonio". Facile da usare, idoneo anche per portatori di occhiali correttivi. Tessuto ad alta resistenza colore giallo ad elevata visibilità, autoestinguente. A norma EN 403:2004 per cappucci di emergenza da utilizzare in caso di incendio, testato anche per l'utilizzo in caso di H2S (2.500 ppm) secondo la norma DIN 58647-7. Confezione singola di cartone.

4 RSD415 - cappuccio di fuga Parat 5510, peso gr 600, classe CO P2

5 RSD817M - marsupio per cappuccio Parat in materiale tessile ad alta tenacità, impermeabile ai liquidi, con fascia addominale, fibbia ad incastro rapido e possibilità di regolazione della lunghezza



AUTORESPIRATORE DI EMERGENZA SAVER CF



Ad aria compressa a flusso costante specificatamente studiato per la fuga dai luoghi confinati in caso di emergenza. Attivazione automatica ad apertura borsa, riduttore di pressione con manometro e segnale acustico di allarme che entra in azione quando nella bombola è rimasta una pressione residua di 50 bar. Cappuccio ignifugo con mascherina oronasale e visore trasparente in materiale flessibile contenuto in sacca a tracolla in tessuto ignifugo. Fornito completo di bombola da lt 2 oppure 3, 200 bar. **A norma EN1146 e direttiva IMO/MED (specifica per l'equipaggiamento marittimo).**

6 RSD492 - con bombola da lt 2, autonomia 10 minuti, peso kg 4,2

RSD491 - con bombola da lt 3, autonomia 15 minuti, peso kg 5,2

7 RSD412 - contenitore in plastica per applicazione murale, per auto-respiratori Saver CF. Dimensioni: (b x h x p): cm 76 x 28 x 21



8 ARMADIO MURALE PER AUTORESPIRATORE



In plastica, può alloggiare un autorespiratore completo di bombola. L'armadio è in grado di contenere anche un'eventuale bombola di scorta. L'alloggiamento del dispositivo all'interno dell'armadio avviene in modo tale che il DPI sia pronto per essere indossato dall'utilizzatore. Porta incenerita su un lato, guarnizione sul perimetro, finestrella di ispezione e doppia chiusura con chiave mappata contenuta nello sportellino trasparente a rottura facilitata.

RSD260 - armadio murale, dimensioni cm 87 h x 57 l x 38 p



9 ARMADIO MURALE PER AUTORESPIRATORE



Modello universale per tutti i tipi di respiratori. In lamiera verniciata, colore azzurro, con chiave. Sportello con lastra in plexiglass.

AST8550 - dimensioni: cm 85 x 50 x 28



Sistema carrellato Airpak 1 ed Airpak 2

Sistema in grado di garantire rifornimento di aria respirabile agli operatori tramite tubo di prolunga; può essere equipaggiato con bombole di aria compressa con capacità fino a 12 litri ognuna. Struttura metallica in acciaio ad alta resistenza rivestito con vernici antistatiche. Dotato di un avvolgitore con 50 metri lineari di tubo antistatico ad alta resistenza (diverse lunghezze fornibili a richiesta fino a un massimo di 100 metri). **A richiesta fornibili configurazioni per più operatori.**



1 AIRPAK 1



RSD228 - sistema Airpak 1
RSD229 - bombola lt 6 300 bar (necessari 2 pezzi)



2 AIRPAK 2



RSD276 - sistema Airpak 2
RSD277 - bombola lt 50 200 bar (necessari 2 pezzi)

Filtri PAS per sistemi di alimentazione d'aria di rete

Robusto, stabile, realizzato in polietilene e munito di manometro di rete. Garantisce aria pulita da una fonte di aria di rete, tratteneo particelle liquide e solide, vapori d'olio e odori, erogando aria conforme ai requisiti della norma EN 12021. Versione portatile con maniglia di trasporto, attacco filettato in entrata e 3 connessioni a sgancio rapido in uscita. Prefiltro interno. **A richiesta fornibile versione per 5 operatori.**



3 SISTEMA DI ALIMENTAZIONE D'ARIA DI RETE



RSD922 - sistema PAS F3500, capacità fino a 760 l/min, 3 uscite
RSD925 - tubazione da m 5 (altre lunghezze fino a 50 m fornibili a richiesta)
RSD928 - ricambio filtro a carbone attivo
RSD927 - ricambio coalescente
RSD929 - ricambio prefiltro



I SISTEMI AIRPAK 1, AIRPAK 2 E FILTRI PAS PREVEDONO L'AGGIUNTA DI CINTURA (CODICE RSD947), MASCHERA (CODICE RSD720) ED EROGATORE (CODICE RSD706).

Articoli a corredo dei sistemi per spazi confinati Airpak 1, Airpak 2 e filtri PAS



4 MASCHERA PANORAMA



Maschera Panorama Nova Standard PE a pieno facciale in EPDM, con attacco unificato M45x3 UNI-EN148-3, dotata di diaframma fonico in materiale composito e di paraflamma in acciaio inox.

RSD720 - maschera Panorama Nova Standard PE



5 CINTURA AIRLINE PAS X-PLORE

Cintura Airline PAS X-plore dotata di segnale acustico per bassa pressione e completa di innesti rapidi (erogatore escluso).

RSD680 - cintura standard (media)

RSD584 - collettore PAS X-plore, senza cintura



7 EROGATORE



RSD706 - erogatore M45x3 PA 90 PLUS sovrappressione

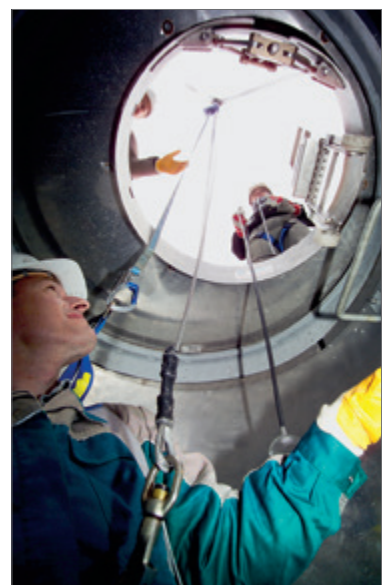

AUTORESPIRATORE COLT PER SPAZI CONFINATI A PAGINA 354.



SISTEMI PER L'INGRESSO E IL RECUPERO IN SPAZI CONFINATI A PAGINA 424.





1 VENTILATORE E ASPIRATORE PER SPAZI CONFINATI

Un'adeguata ventilazione degli spazi confinati è condizione indispensabile da realizzarsi prima di potervi accedere. Per questo i ventilatori e aspiratori sono la soluzione ideale. Il ventilatore UB20 è un ventilatore assiale ad alta pressione, la soluzione ideale per pozzetti e spazi confinati. Potente, versatile e leggero, con telaio in polietilene a doppio strato, a prova di corrosione, resistente alle ammaccature e virtualmente indistruttibile. Alimentazione a corrente, con cavo di alimentazione lunghezza 4,6 metri. Sezione di ventilazione DN 200. Disponiamo inoltre su richiesta di una vasta gamma di ventilatori/aspiratori, con varie tipologie di tubi, raccordi speciali, ventilatori con alimentazione a batteria, ventilatori con portate maggiori per gli spazi più ampi ed infine anche di ventilatori certificati ATEX (richiedi un preventivo).

MED451 - ventilatore 20 cm 1/4HP - 230V + prolunga porta tubo per conversione da ventilazione ad aspirazione (canister) con tubo da 4,6 metri

MED453 - M.E.D (Manhole Entry Device) ventilatore 220V + prolunga porta tubo per conversione da ventilazione ad aspirazione (canister) + tubo da 1,5 metri + raccordo per tombino che agevola l'ingresso/uscita degli operatori dal pozzetto + tubo da 4,6 metri



2 SISTEMA UOMO A TERRA BODYGUARD 1000

Leggero (215 g), robusto e resistente, progettato per proteggere la vita avvisando la squadra quando chi lo porta è immobile o in difficoltà. Emette segnali e allarmi chiari e distinti per garantire di essere rintracciati in modo rapido ed efficace, anche nelle peggiori condizioni ambientali. Uso semplice ed intuitivo, compatibile con tutti gli autorespiratori. Bande luminose, archivio storico elettronico dell'incidente, possibilità di scegliere diverse modalità operative. A tenuta d'acqua (IP67), funzionante da -30°C a +60°C. Esente da manutenzione periodica, sostituzione della batteria quando è necessaria. **Certificazione ATEX IIM / IIIGD Ex IA I/II C T4.**

RSD131 - sistema uomo a terra Bodyguard 1000, dimensioni mm 100 x 70 x 40 mm



RILEVATORE DI GAS PAC® 6000

Identifica velocemente la presenza di gas e memorizza fino a 60 eventi. Durata di vita utile: 2 anni senza necessità di calibrazione. Allarmi: vibrante, acustico (multitono >90 dB a 30 cm) e visivo (led lampeggianti). IP68 per garantire lo svolgimento delle operazioni anche in presenza di spruzzi d'acqua. Durata della batteria al litio per 8 ore di utilizzo al giorno e 1 minuto di allarme al giorno: 2 anni per CO, H₂S; 10 mesi per O₂. Omologato: ATEX I/II M 1/1 G EEx ia I/II C T4 - UL - cUL - IECEx - GOST. Dimensioni: mm 84 x 64 x 25, peso gr 120.

3 RSD111 - rilevatore per gas CO (monossido di carbonio)

4 RSD112 - rilevatore per gas H₂S (idrogeno solforato)

5 RSD113 - rilevatore per gas O₂ (ossigeno)

6 RSD114 - rilevatore per gas SO₂ (anidride solforosa)

7 RILEVATORE MULTI GAS X-AM 2500

Per la rilevazione portatile di gas. Display alfanumerico per identificare facilmente i valori misurati, due pulsanti per navigare facilmente nel software dello strumento. Clip per applicazione all'indumento dell'utilizzatore. Allarmi: vibrante, acustico e visivo led. **Grado di protezione IP67.** Fornito con batteria ricaricabile. Omologazioni: ATEX I M1 Ex ia I Ma, II 1G Ex ia IIC T3 Ga, I M2 Ex d ia I Mb, II 2G Ex d ia IIC T4/T3 Gb. Datalogger (memorizza dati sino a 100 ore) incluso. Fornibile modello completo di pompa elettrica con tubo 3 m (capacità di aspirazione sino a 45 m di distanza), filtro antipolvere e valigetta per l'utilizzo in zone confinate prima dell'accesso dell'utente. Dimensioni: mm 130 x 48 x 44. Peso: gr 220.

7 RSD16 - rilevatore di 4 gas (Ch₄, O₂, H₂S e CO) con batteria ricaricabile

RSD17 - rilevatore di 4 gas (Ch₄, O₂, H₂S e CO) con batteria ricaricabile e pompa elettrica per campionamento

RSD20 - rilevatore di 2 gas (H₂S e SO₂) con batteria ricaricabile

RSD21 - rilevatore di 2 gas (H₂S e SO₂) con batteria ricaricabile e pompa elettrica per campionamento

8 RSD18 - custodia di trasporto in nylon



PROTEZIONE DELL'UDITO: LE NORME, I DANNI DA RUMORE, COME PROTEGGERSI

MISURE ATTE A RIDURRE IL RISCHIO INDIVIDUALE DI IPOACUSSIA INDOTTA DA RUMORE



RIFERIMENTI LEGISLATIVI

“DECRETO LEGISLATIVO 81/2008 - TITOLO VIII: AGENTI FISICI CAPO II - I RISCHI DI ESPOSIZIONE AL RUMORE”

La presente Direttiva stabilisce prescrizioni minime di protezione dei lavoratori contro i rischi per la loro salute e sicurezza che derivano, o possono derivare, dall'esposizione al rumore e stabilisce i parametri fisici utilizzati quali indicatori del rischio.

SINTESI DELLE SPECIFICHE DELLA UNI EN 352:

EN352/1: cuffie auricolari

EN352/2: inserti auricolari

EN352/3: cuffie per elmetto

EN352/4: cuffie elettroniche

EN352/5: Cuffie con controllo attivo della riduzione del rumore

EN352/6: Cuffie con comunicazione audio

EN352/7: Inserti con attenuazione in funzione del livello sonoro

EN352/8: Cuffie con possibilità di ascolto audio non legato al lavoro

OBBLIGHI PER IL DATORE DI LAVORO

- **Livello di esposizione quotidiana >80dB(A):**
fornitura dei dispositivi di protezione auricolare (utilizzo volontario), addestramento all'uso corretto, formazione sui rischi legati al rumore
- **Livello di esposizione quotidiana >85dB(A):**
fornitura dei dispositivi di protezione auricolare (obbligo di utilizzo), addestramento all'uso corretto, formazione sui rischi legati al rumore, segnalare le aree rumorose con segnaletica idonea.
- **Livello di esposizione quotidiana >87dB(A):**
massimo livello di rumore consentito nell'ambiente lavorativo indossando i dispositivi di protezione

DANNI CONSEGUENTI ALL'ESPOSIZIONE AL RUMORE

Muscoli, peli e cere presenti nel canale auricolare sono una naturale difesa contro le particelle di polvere e sporco, ma non esiste una difesa naturale contro il rumore. Le cellule ciliate, che si distruggono quando si è sottoposti ad eccessivo rumore, NON si ricreano e piano piano senza accorgersi ci si ritrova con problemi di ipoacusia. Per questo motivo è importante usare i mezzi di protezione dell'udito.

SINTOMI DELLA PERDITA DELL'UDITO

I sintomi principali sono: ronzii nell'orecchio, suoni ad alta o bassa frequenza percepiti più debolmente, difficoltà nel capire le conversazioni. La sensazione generale è che tutti i suoni sembrino soffocati. La perdita dell'udito è un danno irreversibile.

CALCOLO DELL'ABBATTIMENTO

Il metodo più semplice è il metodo SNR (Single Number Rating).

Ma che cosa è il Single Number Rating?

"Esprime con un solo valore, in dB, l'attenuazione sonora semplificata (Simplified Noise Reduction) del DPI; il fabbricante ricava questo valore dai valori in banda d'otava. L'attenuazione deve essere tale da non generare una protezione insufficiente o, viceversa, una iperprotezione; lo spettro di attenuazione dovrebbe essere scelto in funzione dello spettro del rumore da cui proteggere e delle modalità di espletamento del lavoro".

ESEMPIO DI CALCOLO DELL'ABBATTIMENTO

- Livello di rumore misurato nell'ambiente di lavoro: 100 dB(A)
- Livello di rumore attenuato dall'otoprotettore SNR:
(VALORE DICHIARATO DAL FABBRICANTE 35 dB - LIVELLO DI RUMORE = 100 - 35 = 65 dB(A))

GUIDA ALLA SCELTA

I dispositivi di **protezione auricolare** sono definiti come un **Dispositivo di Protezione Individuale** devono essere accompagnati dai dati di attenuazione sonora forniti dal fabbricante. Grazie alla loro proprietà di attenuazione riducono gli effetti del rumore sull'udito al fine di evitare un danno uditivo. Si possono distinguere 2 tipologie di dispositivi di protezione auricolare: inserti auricolari e cuffie auricolari.

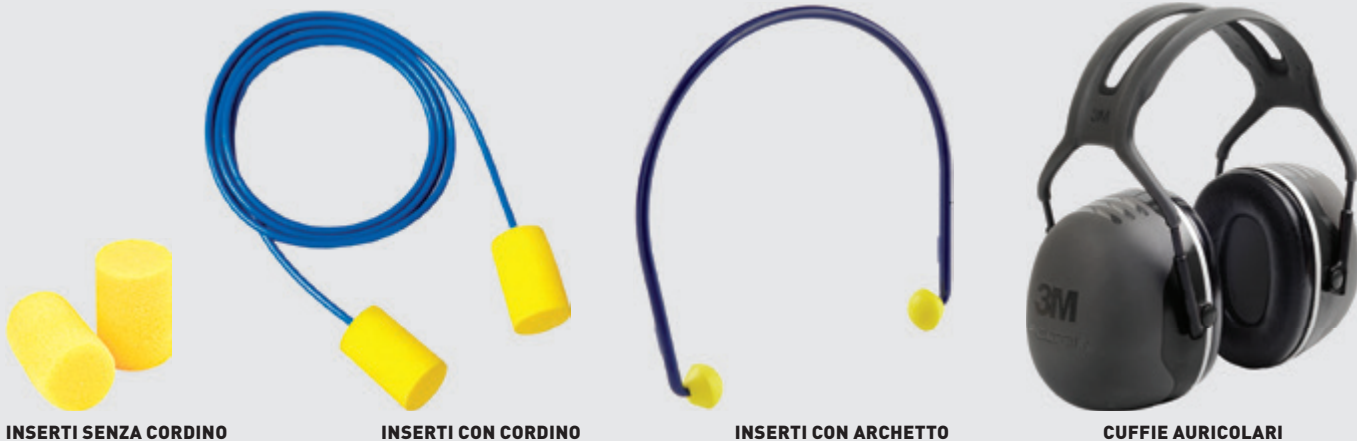

INSERTI AURICOLARI

Gli inserti auricolari si inseriscono nella conca del padiglione auricolare per chiudere a tenuta l'imbocco del meato acustico esterno. Si suddividono in due categorie: riutilizzabili o monouso e in 3 tipologie: con cordino, senza cordino, con archetto. (Gli inserti auricolari possono anche essere realizzati su misura, si tratta di inserti realizzati normalmente in materiale plastico modellato su un'impronta dei meati acustici interni del portatore e vengono spesso adottati in casi di allergie verso i materiali con cui vengono realizzati gli altri otoprotettori).

CUFFIE AURICOLARI

Le cuffie auricolari sono costituite da due conchiglie contenente materiale spugnoso fonoassorbente, che coprono le orecchie creando un contatto ermetico con la testa per mezzo di cuscinetti morbidi solitamente riempiti di schiuma. Sono collegate con un archetto di sostegno per una tenuta sicura e confortevole oppure con attacchi specifici per agganciarsi all'elmetto. Le cuffie sono destinate a coprire la maggior parte delle dimensioni delle teste esistenti tra i lavoratori Europei.

LA NORMA EUROPEA EN458

Nella nuova versione, pone l'attenzione sul corretto indossamento, individuandolo come fattore chiave per garantire il corretto livello di protezione ed invitando a fare una valutazione del reale abbattimento dell'otoprotettore. Fra i criteri di selezione è importante considerare fattori che possono influire sulla confortevolezza e sull'accettabilità da parte dell'utilizzatore. Inoltre fra le misure atte a ridurre il rischio individuale di ipoacusia indotta da rumore, oltre ai Dispositivi di Protezione Individuali, bisogna porre attenzione prioritaria ad altri elementi come l'identificazione delle aree di rumore, la valutazione dell'esposizione personale al rumore e la riduzione dei rumori.





PROTEZIONE DELL'UDITO

3M**EAR****PELTOR****RNR <85 dB (A)**

Non è necessario indossare protezioni acustiche, ma fornitele ai vostri dipendenti

RNR 83-93 dB (A)

Siete al di sopra del livello: la protezione acustica è obbligatoria

RNR 87-98 dB (A)

Siete al di sopra del livello: la protezione acustica è obbligatoria. Ideale per rumori ad alta frequenza

RNR 94-105 dB (A)

Siete al di sopra del livello: la protezione acustica è obbligatoria. Ideale per rumori ad alta/media frequenza

RNR 95-110 dB (A)

Siete al di sopra del livello: la protezione acustica è obbligatoria. Ideale per tutte le frequenze

**1****2****3**

3M™ E-A-R™ CLASSIC™



Inserti auricolari in soffiche espanso polimerico a lenta espansione. Non provocano irritazioni. Fornibili in 2 modelli: Classic e Classic Small con diametro ridotto per canali auricolari medio-piccoli. A norma EN352.2.

1 APE6200 - E-A-R™ Classic™, distributore da 250 coppie

2 APE6515 - E-A-R™ Classic™ in bustina di polipropilene, distributore da 200 coppie

3 APE6220 - E-A-R™ Classic™ Small, distributore 250 coppie

E-A-R™ Classic - attenuazione (in dB): H=30 M=24 L=22 SNR=28

E-A-R™ Classic Small - attenuazione (in dB): H=31 M=25 L=21 SNR=28

**4**

3M™ E-A-R™ SOFT 21™



Studiati per livelli di rumore fino a 93 dB(A). Di facile utilizzo, si inseriscono spingendo semplicemente nel canale auricolare poichè non necessitano di essere premodellato. A norma: EN352.2.

APE6209 - scatola distributrice da 250 coppie

Attenuazione (in dB): H=24 M=17 L=14 SNR=21

**5****6****7**

DISTRIBUTORE ONE TOUCH PRO PER 3M™ E-A-R™ CLASSIC™ E 3M™ E-A-R™ SOFT™



Distributore in metallo, a parete o da banco, azionabile con un solo movimento (ricariche escluse).

5 AP2043 - distributore One Touch Pro, solo base

6 APE6310 - contenitore trasparente completo di 500 coppie d'inserti E-A-R™ Classic™ (per AP2043)

7 APE6320 - contenitore trasparente completo di 500 coppie d'inserti E-A-R™ Soft™ (per AP2043)

APE6311 - ricarica in sacchetti da 500 coppie d'inserti E-A-R™ Classic™ (per APE6310)

APE6321 - ricarica in sacchetti da 500 coppie d'inserti E-A-R™ Soft™ (per APE6320)

**8**

3M™ E-A-R™ CLASSIC CORDED™



Inserti auricolare Classic con l'aggiunta di un cordino ben visibile, in vinile blu che stimola a riutilizzare l'inserto. Particolarmente adatti nelle industrie alimentari e manifatturiere. A norma: EN352.2.

APE6210 - scatola distributrice da 200 coppie

Attenuazione (in dB): H=30 M=26 L=23 SNR=29

**9**

3M™ E-A-R™ SOFT™



Inserti auricolari in morbido polimero spugnoso dal design affusolato. Dermatologicamente testati, non irritano la pelle. Il liscio polimero a lenta espansione esercita la minima pressione sul condotto auricolare rendendoli particolarmente confortevoli. A norma: EN352.2.

APE6290 - scatola distributrice da 250 coppie

Attenuazione (in dB): H=34 M=34 L=31 SNR=36

**10****11**

E-A-R™ EXPRESS™



Inserti auricolari riutilizzabili in schiuma. Dotati di gambino per la massima igiene, non occorre toccare la schiuma in fase di inserimento. Indicati in ambienti lavorativi particolarmente sporchi. Minimo ordinabile 100 coppie/multipli. Conformi alla norma: EN352.2.

10 AP6260 - modello senza cordino

11 AP6261 - modello con cordino

Attenuazione (in dB): H=30 M=24 L=22 SNR=28



1 3M™ E-A-R™ PUSH-INS™

Inseri auricolari con stelo, con il più alto livello di attenuazione, **riutilizzabili** in materiale spugnoso. Grazie al gambo non è necessario toccare il filtro sia per l'inserimento che per la rimozione per una massima igiene. La particolare struttura spugnosa si ammorbidisce e diviene più duttile in base alla temperatura corporea. Minimo ordinabile 100 coppie/multipli. A norma EN352.2.

1 **AP6250** - modello con cordino

2 **AP6251** - modello senza cordino

Attenuazione [in dB]: H=37 M=36 L=34 SNR=38



2



3 3M™ E-A-R™ SOFT METAL DETECTABLE™

Inseri auricolari in morbido poliuretano **per le industrie alimentari (HACCP)** rilevabili al metal detector tramite sfera d'acciaio integrata nel filtro stesso. Atossici ed ipoallergenici. A norma EN352.2.

APE6270 - scatola distributrice da 200 coppie

Attenuazione [in dB]: H=34 M=34 L=31 SNR=36



4 3M™ E-A-R™ TRACER™

Inseri auricolari **riutilizzabili** con sfera di acciaio incorporata nello stelo rilevabile al metal-detector. Particolarmente adatti **per le industrie alimentari (HACCP)**. A norma EN352.2.

AP6240 - minimo ordinabile 50 coppie/multipli

Attenuazione [in dB]: H=33 M=28 L=25 SNR=32



5 3M™ E-A-R™ ULTRAFIT™

Inseri auricolari **riutilizzabili**. La struttura a flange rende più ampia la zona di contatto tra l'inserito e il canale auricolare, in modo da ottenere un efficace grado di attenuazione dei rumori. Forniti con cordino applicabile. A norma EN352.2.

AP6230 - minimo ordinabile 50 coppie/multipli

Attenuazione [in dB]: H=33 M=28 L=25 SNR=32



9

10

1100/1110

Inseri auricolari in schiuma poliuretana morbida e ipoallergenica. Forma conica progettata per modellarsi ai diversi condotti auricolari. A norma: EN352.2.

9 **APT1110** - modello con cordino, scatola distributrice 100 coppie/multipli

10 **APT1100** - modello senza cordino, scatola distributrice 200 coppie/multipli

Attenuazione [in dB]: H=37 M=34 L=31 SNR=37



Archetti semiauricolari



6

7

3M™ E-A-R™ CAP™

Archetto semiauricolare per alti livelli di rumore. Costituito da tamponi in espanso morbido fonoassorbenti. Leggero (8 g), indicato ad un uso continuato. Ideale anche per visitatori. A norma: EN352.2.

6 **AP6420** - archetto E-A-R™ CAP™, minimo ordinabile 10 archetti/multipli

7 **AP6421** - inserti di ricambio, minimo ordinabile 10 coppie/multipli

Attenuazione [in dB]: H=27 M=19 L=17 SNR=23



8

8 3M™ 1310

Archetto semiauricolare adatto per entrare ed uscire da zone molto rumorose. Peso gr 13. A norma: EN352.2.

AP1310 - archetto 3M™ 1310, minimo ordinabile 10 archetti/multipli

AP1311 - tamponi ricambio, minimo ordinabile 20 coppie/multipli

Attenuazione [in dB]: H=30 M=22 L=19 SNR=26



12

11

1261/1271

Inseri auricolari in monoprene con custodia e clip per aggancio a cintura in modo da conservarli e proteggerli dallo sporco. Minimo ordinabile 50 coppie/multipli. A norma EN352.2.

11 **AP1261** - colore arancione senza cordino

12 **AP1271** - colore arancione con cordino

Attenuazione [in dB]: H=27 M=22 L=20 SNR=25



**1****2**

1 SISTEMA WIRELESS SERIE X



Per utilizzo con cuffie 3M serie X temporali e per elmetto. Facile utilizzo: si rimuove il cuscinetto della cuffia e si inserisce il dispositivo. Con tecnologia wireless Bluetooth per sincronizzare il cellulare, un solo pulsante multifunzione. IP54, 8 ore di conversazione /streaming. Peso gr 55.

APH310 - sistema di comunicazione wireless per cuffie serie X

**3**

3 CARTINE ANTISUDORE

APH100 - confezione da 100 paia di cartine compatibili con tutti i tipi di cuffie Peltor

2 3M™ PELTOR™ X1



Isolata elettricamente, peso ridotto e doppia bardatura per una maggiore stabilità. Attenuazione standard. Coppe sottili e attenuazione in grado di soddisfare le esigenze dei diversi ambienti industriali.

APH447 - bardatura temporale, peso gr 184

APH469 - attenuazione (in dB): H=32 M=24 L=16 SNR=27

**4****5****6**

3M™ PELTOR OPTIME™ I



Profilo basso senza parti sporgenti, compatibili con altri DPI. Auricolari ampi e morbidi, facili da utilizzare anche per chi porta gli occhiali. Attacco a 2 punti. Semplice manutenzione. A norma EN352-1.

4 APH511 - bardatura temporale, peso gr 180

5 APH512 - bardatura nucale, peso gr 165

6 APH513 - cuffie attacco per elmetto G3000, peso gr 205. A norma EN352-3

APH336 - come sopra + attacco per G2000

APHY51 - ricambio coppia tamponi + coppia cuscinetti

APH511 - attenuazione (in dB): H=32 M=25 L=15 SNR=27

APH512 - attenuazione (in dB): H=32 M=25 L=15 SNR=27

APH513 - attenuazione (in dB): H=32 M=23 L=15 SNR=26

**7****8****9**

3M™ PELTOR OPTIME™ II



Per ambienti rumorosi. Tenuta ottimale degli auricolari grazie ad un mix di liquido e schiuma, pressione contenuta a garanzia di comfort. Canali di ventilazione rivestiti con una pellicola igienica. A norma EN352-1.

7 APH521 - bardatura temporale, peso gr 210

8 APH522 - bardatura nucale, peso gr 195

9 APH523 - cuffie attacco per elmetto G3000, peso gr 235. A norma EN352-3

APHY52 - ricambio coppia tamponi + coppia cuscinetti

APH521 - attenuazione (in dB): H=34 M=29 L=20 SNR=31

APH522 - attenuazione (in dB): H=34 M=29 L=20 SNR=31

APH523 - attenuazione (in dB): H=34 M=28 L=19 SNR=30

**10****11****12**

3M™ PELTOR OPTIME™ III



Per ambienti particolarmente rumorosi. Una nuova tecnologia riduce le risonanze all'interno del guscio della coppa. Auricolari ampi e riempiti di schiuma morbida per un'ottima tenuta e bassa aderenza. A norma EN352-1.

10 APH541 - bardatura temporale, peso gr 285

11 APH542 - bardatura nucale, peso gr 270

12 APH543 - cuffie attacco per elmetto G3000, peso gr 310. A norma EN352-3

APHY54 - ricambio coppia tamponi + coppia cuscinetti

APH541 - attenuazione (in dB): H=40 M=32 L=23 SNR=35

APH542 - attenuazione (in dB): H=40 M=32 L=23 SNR=35

APH543 - attenuazione (in dB): H=40 M=32 L=22 SNR=34

**13****14**

CUFFIE DIELETRICHE CON ATTENUAZIONE IMPAREGGIABILE!

3M™ PELTOR™ X5



Isolata elettricamente, massima attenuazione, coppe imbottite e anello di tenuta. Coppe standard con peso ridotto per un miglior comfort dell'utilizzatore. A norma EN 352-1.

13 APH469 - bardatura temporale, peso gr 351

14 APH498 - cuffie attacco per G3000 e G2000, peso gr 353. A norma EN 352-3

APH469 - attenuazione (in dB): H=37 M=35 L=27 SNR=37

APH498 - attenuazione (in dB): H=36 M=34 L=26 SNR=36



CUFFIE ANTIRUMORE PER ELMETTI KASK A PAGINA 366.



DECRETO LEGISLATIVO 81/08 LIVELLO DI ESPOSIZIONE LEX, 8H ≥85 dB (A)



Obbligo da parte del lavoratore di utilizzare i mezzi di protezione individuali messi a loro disposizione dal datore di lavoro.

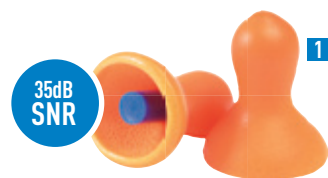

1 QUIET



Ipoallergenici, riutilizzabili, senza cordoncino dalla forma sagomata per una perfetta adesione ai contorni del condotto uditivo. Stelo rigido integrato per facile e rapido inserimento.

APB8456 - scatola da 50 coppie

Attenuazione (in dB): H=29 M=25 L=23 SNR=28



2 SERIE 300



Inseri auricolari in schiuma poliuretanicca ad espansione graduale, struttura conica a superficie liscia. Disponibile nelle taglie Small e Large. A norma: EN352.2.

APB5073 - scatola da 200 coppie taglia Large

APB5074 - scatola da 200 coppie taglia Small

Attenuazione (in dB): H=32 M=29 L=29 SNR=33



3 LASER LITE



Inseri auricolari in schiuma poliuretanicca ad espansione graduale in colori vivaci per una maggior visibilità. Forma a "T" per un inserimento più facile. A norma: EN352.2

APB1105 - scatola da 200 coppie taglia unica

Attenuazione (in dB): H=34 M=32 L=31 SNR=35



4 PERCAP



Archetto con morbidi inserti in schiuma sostituibili. Pieghevole per essere riposto in tasca. Conforme alla norma EN352.2.

APB5952 - minimo ordinabile 10 archetti/multipli

APB5980 - scatola da 10 paia di ricambi per archetto Percap

Attenuazione (in dB): H=27 M=20 L=18 SNR=24



5 SMARTFIT



Inseri auricolari con cordoncino. Si modellano con il calore del condotto uditivo, adattandosi ad ogni conformazione offrendo una vera soluzione personalizzata.

APB1239 - minimo ordinabile 50 coppie/multipli, conformi alla norma: EN352.2

Attenuazione (in dB): H=32 M=27 L=23 SNR=30



6 DISTRIBUTORE HL400



Leggero e resistente, fornito completo di 400 paia di inserti auricolari 300 taglia L, erogabili ruotando la manopola. Base inseribile su supporti di altri dispenser. Può essere montato a parete o su superficie orizzontale.

APB9767 - distributore HL400 fornito completo

APB6186 - ricarica da 200 paia inserti serie 300 taglia L per distributore HL400



7 SYNC WIRELESS



Cuffia attiva comoda e facile da utilizzare, con tecnologia wireless Bluetooth per sincronizzare il cellulare, un solo pulsante multifunzione. Microfono con protezione antivento, batteria al litio per oltre 16 ore di utilizzo. Cavo USB e caricabatteria inclusi. Elevata attenuazione passiva (esclude l'80% del rumore ambientale). A norma 352-2.

APB4510 - cuffia attiva Sync Wireless Bluetooth

APB5280 - kit ricambi 1 paio di cuscinetti e inserti per cuffia attiva Sync® Wireless

Attenuazione (in dB): H=33 M=30 L=24 SNR=32



8 VERISHIELD



Buona attenuazione. Stabile regolazione a forcella delle coppe, per mezzo del solido archetto con anima metallica. L'appoggio dell'archetto sul capo è reso confortevole da un'imbottitura morbida e ampia. Cuscinetti in memory foam, per un appoggio confortevole, e per minimizzare la perdita di tenuta in caso di abbinamento con occhiali. Coppe in ABS, imbottitura coppe in schiuma PU. Peso g 210. Conforme alla norma: EN 352-1.

APB0120 - cuffia antirumore bardatura temporale

APB0120R - kit ricambio coppia di cuscinetti e imbottiture delle coppe

Attenuazione (in dB): H=31 M=35 L=28 SNR=30

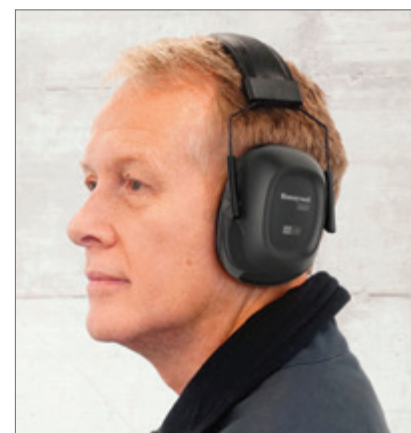

ELMETTI DI PROTEZIONE: LE NORME



Gli elmetti proteggono il capo dall'impatto e dalla caduta di oggetti. Il grado di protezione che possono offrire è condizionato, da una parte, dai limiti fisiologici di tollerabilità della sollecitazione d'urto, dall'altra la difficoltà di ordine tecnico connesso alla realizzazione di un mezzo che deve, nello stesso tempo, possedere un'adeguata resistenza meccanica, un'elevata capacità ammortizzante ed un peso non elevato.

LE NORME

EN397 - ELMETTO DI PROTEZIONE PER LE INDUSTRIE

Questa norma per la marcatura prevede:

- il numero della presente norma europea
- il nome o la marca del fabbricante
- l'anno e il trimestre di fabbricazione
- il tipo di elmetto (indicazione del costruttore)
- la taglia/grandezza (in cm)

Indicazioni complementari, quali le istruzioni o raccomandazioni di regolazione, montaggio, uso, lavaggio, disinfezione, manutenzione e stoccaggio, sono specificate nella nota informativa.

EN 812 - CASCO ANTIURTO

Norma relativa a protezioni per la testa atti a proteggerla da lacerazioni o altre ferite superficiali. Questi dispositivi sono prevalentemente destinati a utilizzatori che lavorano in ambienti interni (non devono in nessun caso sostituire un elmetto di protezione per l'industria, regolato dalla norma EN397).

EN 443 - CASCHI PER VIGILI DEL FUOCO

Questa norma specifica le caratteristiche richieste agli elmetti di protezione utilizzati per i servizi di soccorso e per la lotta contro gli incendi e determina i metodi di prova che permettono di verificare queste caratteristiche.

EN 50365 - ELMETTI ISOLANTI

Questa norma specifica le caratteristiche richieste agli elmetti destinati ad essere utilizzati in ambienti in cui vi è la possibilità di contatto con un elevato potenziale di tensione elettrica (fino a 1.000 Volts AC e 1.500 Volts DC). Questo standard supera i requisiti delle prove facoltative di resistenza elettrica a norma EN397 e EN812 e i requisiti elettrici del EN443. Utilizzati insieme ad altri dispositivi elettricamente isolanti, proteggono i lavoratori dalle correnti pericolose.





1 ELMETTI ZENITH X

Elmetto dielettrico con regolazione millimetrica della taglia tramite rondella, calotta esterna in polipropilene, calotta interna in HD polistirolo espanso, fascia antisudore in nylon morbido, completo di sottogola. Taglia regolabile da 52 a 63 cm. **Conforme alle norme EN397 - EN50365 (Classe 0).**

Colori standard: **W** bianco **B** blu. Fornibili a richiesta: **HV** HI VIZ (inserti luminescenti)

ELE90. - elmetto ZENITH X dielettrico con sottogola, peso 490 g



2 ELMETTI PRIMERO

Elmetto con sistema di attacco che consente di agganciare e sganciare facilmente l'imbottitura. Calotta esterna in polipropilene, interna in polistirene espanso, fascia antisudore in nylon morbido. Ben ventilato, grazie alle 14 prese d'aria sagomate che migliorano traspirabilità e comfort, anello per cinturino sottogola che consente di fissare saldamente il casco a un'imbracatura. Slot per il fissaggio di cuffie antirumore. Sistema di regolazione della taglia del casco mediante rotella: il sistema si sposta verso l'alto e verso il basso per adattarsi a una vasta gamma di forme della testa. Taglia regolabile da 52 a 63 cm. **Conforme alle norme EN397 - EN50365 (Classe 0).**

2 ELE320. - elmetto Primero con sottogola, peso 460 g. Colori: **W** bianco **N** nero **R** rosso **Y** giallo **B** blu **G** verde

3 ELE4221. - elmetto Primero ad alta visibilità con sottogola, peso 460 g. Colori: **Y** giallo alta visibilità **W** bianco alta visibilità



ACCESSORI PER ELMETTI ZENITH X E PRIMERO

- 4 TV001** - supporto per visiera full face Zen, da abbinare all'adattatore TV004
- 5 TV017** - visiera corta Zen peso 80 g, in policarbonato trattamento antiappannante ed antigraffio, lente panoramica sovrapponibile agli occhiali correttivi, bordo antitaglio, profilo in gomma antigocciolamento. Clip fermalampada. Compatibile con elmetti Zenith X e Primero tramite adattatore TV004
- 6 TV004** - adattatore per attacco visiere Zen agli elmetti Zenith X e Primero
- 7 TV019** - visiera Zen full face per elmetti Zenith X e Primero. Da usare con adattatore TV004 e supporto TV001
- 8 TV014** - visiera Arc Flash in policarbonato per arco elettrico classe 1, a norma EN166 - EN170. Si aggancia direttamente all'elmetto dielettrico ELE90. Dielettrico 1000 V. Classe ottica: 1. Trasmissione luminosa NA: 88%. Indice di resa cromatica: > 95%. Protezione dagli schizzi di liquidi: 3. Protezione da particelle ad alta velocità: energia d'impatto media (B). Peso: 294 g. Certificazioni: GS-ET-29: Class 1 2C 1,2 K 1 B 8-1-0 3





ELMETTI SUPERPLASMA

Elmetto con sistema di attacco che consente di agganciare e sganciare facilmente l'imbottitura. Calotta esterna in polipropilene, interna in polistirene espanso, fascia antisudore in nylon morbido. Ben ventilato, grazie alle 10 fessure d'aerazione, che migliorano traspirabilità e comfort, protette da griglia in alluminio e anello per cinturino sottogola che consente di fissare saldamente il casco a un'imbracatura. Punti di attacco per il fissaggio di cuffie antirumore e visiera. Sistema di regolazione della taglia del casco che garantisce la massima stabilità, facile da utilizzare grazie ad una rotella di grande diametro. Taglia regolabile da 51 a 63 cm. **Conforme alle norme EN397 - EN50365 (Classe 0).**

1 ELE4201. - elmetto Superplasma con sottogola, peso 390 g. Colori: **W** bianco **N** nero **R** rosso **Y** giallo **B** blu **G** verde

2 ELE4211. - elmetto Superplasma ad alta visibilità con sottogola, peso 390 g. Colori: **Y** giallo alta visibilità **W** bianco alta visibilità



ELMETTO PLASMA AQ



Casco leggero, compatto, confortevole e ben ventilato grazie alle 10 fessure d'aerazione protette da griglia in alluminio. Taglia regolabile dalla 51 alla 62 e regolazione millimetrica della taglia tramite rondella. Calotta esterna in polipropilene ad alta densità resistente agli urti. Fascia antisudore e bardatura imbottite per un comfort estremo, notevole resistenza al freddo, al vento, elevata traspirabilità. Cinturino sottogola con chiusura e apertura a sgancio rapido <25 kg. Bardatura removibile e lavabile. Peso 390 g. Conforme alla norma EN 397.

3 ELE88. - casco Plasma AQ. Colori standard: **W** bianco **R** rosso **B** blu **Y** giallo.

Fornibili a richiesta: **A** arancio **Z** royal **G** green **H** british green

4 ELE89. - casco Plasma HI-VIZ con inserti luminescenti e rifrangenti.

Colori standard: **W** bianco **Y** giallo. Fornibili a richiesta: **L** lime fluo

ACCESSORI PER ELMETTI PLASMA E SUPERPLASMA

5 TV016 - visiera full face linea in polycarbonato trasparente antigraffio antiappannante, a norma EN166

6 TV020 - visiera corta V2 PLUS trasparente, in polycarbonato, antigraffio, antiappannante, provvista di bordo antitaglio e antigocciolamento in gomma, a norma EN166, EN170, EN14458, ANSI Z87.1 2 - 1,2 1BT



PER AMBIENTI MOLTO RUMOROSI.



PER AMBIENTI CON LIVELLO DI RUMORE MEDIO-ALTO.



PER AMBIENTI CON LIVELLO DI RUMORE DA BASSO A MEDIO (DB).



CUFFIE ANTIRUMORE COMPATIBILI CON TUTTI I MODELLI KASK



Attacco universale da 30 mm, regolazione telescopica continua della taglia, realizzate in materiale non conduttivo. **Si applicano a tutti gli elmetti Kask tramite gli adattatori TV003 da acquistare separatamente (agli elmetti ZenithX e Primero si applicano senza adattatori).** A norma EN 352-3.

7 APEK203 - cuffie antirumore colore arancio (rumore a bassa frequenza). Attenuazione (in dB): H= 32 M=30 L=21 SNR=31

8 APEK202 - cuffie antirumore colore giallo (rumore livello medio-alto). Attenuazione (in dB): H= 31 M=27 L=20 SNR=29

9 APEK205 - cuffie antirumore colore verde (rumore da basso a medio - dB - e con frequenza medio-alta). Attenuazione (in dB): H= 27 M=23 L=16 SNR=25

10 TV003 - coppia adattatori per cuffie necessari per l'utilizzo con tutti gli elmetti Kask (tranne serie Zenith X e Primero)



A DIFFERENZA DELLE ALTRE COLORAZIONI, L'ELMETTO DIELETRICO ANCE0747HV HA ANCHE GLI ADESIVI RIFLETTENTI



Photo Rikky Feldner, © C.A.M.P.

1 ELMETTO DIELETRICO ARES PER LAVORI IN QUOTA



Elmetto dielettrico, confortevole e di elevati standard prestazionali, particolarmente indicato per i **lavori in quota**. Calotta in ABS e PC, completamente chiusa per la protezione contro rischi elettrici o proiezioni di metallo fuso. Predisposizione per fissaggio cuffie. Fettuccia sottogola con fibbia a sgancio di sicurezza. Taglia regolabile 54-62 cm con rotella. **A norma EN397 e EN50365 Classe 0**, inclusi i requisiti di deformazione laterale (LD), isolamento elettrico (440 V a.c.) temperatura molto bassa (-20°C) spruzzi di metallo fuso (MM) e uso in prossimità di installazioni elettriche fino a 1000 V c.a. o 1500 V c.c.

ANCE0747 - elmetto dielettrico con sottogola, peso 470 gr. Colori:

HV Hi-Viz **W** bianco **R** rosso **Y** giallo **A** arancione **B** azzurro **G** verde

2 ELMETTO SKYLOR PLUS



Elmetto con calotta in ABS stampata ad iniezione, dal design innovativo per una praticità di utilizzo ed un comfort unici. Predisposizione fissaggio cuffie e visiera protettiva, interno confortevole staccabile e lavabile, **clips portalampada (A)**, **regolazione rapida a rotella (B)**. Sottogola a sgancio di sicurezza. Taglia regolabile: 54-62 cm. Omologazioni aggiuntive: 440V A.C., isolamento elettrico, LD, Deformazione laterale, -20°C, MM, spruzzo di metallo fuso. Peso 475 gr. A norma EN397.

ANCE0209 - elmetto tesa corta. Colori: **W** bianco **R** rosso



ELMETTO CONCEPT DIELETRICO



Elmetto in ABS tesa corta (20 mm), non ventilato, bardatura tessile a 6 punti, deformazione laterale (LD), metallo fuso (MM), resistenza termica fino a -30 °C, ultra leggero (peso 305 g). Misura cm 51-63. Comprensivo di fascia antisudore Hydro-Flock in spugna 4 mm. Regolazione millimetrica con rondella. Altri colori fornibili a richiesta. Isolamento elettrico 440 V, 1000 V (EN397), 20.000 V (ANSI Standard). **A norma: EN397, ANSI Z89.1-2003 type 1 Class E, EN50365.**

- 3 ELE60A** - elmetto dielettrico tesa corta colore arancione
- 4 TV810** - visiera per archi elettrici 230 mm in policarbonato trasparente per elmetto Concept EN 166:2001
- TV811** - supporto visiera per arco elettrico per elmetto Concept



ELMETTO SPECTRUM DIELETRICO



Elmetto con occhiali di protezione integrati a scomparsa (utilizzabili anche con occhiali da vista), protezione impatto tipo B (impatto a media energia) modello ampio, offre maggiore protezione. In ABS visiera corta (20 mm), non ventilato, deformazione laterale (LD), bardatura tessile a 6 punti, resistenza termica fino a -30 °C, peso 440 g. Misura cm 51-63. Comprensivo di fascia antisudore Hydro-Flock in spugna 4 mm. Altri colori fornibili a richiesta. **A norma: EN397, ANSI Z89.1-2003 type 1 Class E, EN50365.**

- 5 ELE61W** - elmetto Spectrum colore bianco, occhiali di protezione inclusi
- 6 ELE61WP** - elmetto Spectrum colore bianco, versione con portabadge



PROTEZIONE DEL CAPO E DEL VISO



ELMETTI BERICO



Elmetto economico in polietilene, bardatura interna a 4 punti in tessuto, frontalino antisudore in spugna. Resistente alle basse temperature (-20°C), isolamento elettrico 440 Vca. A norma: EN397. Peso gr 300.

Colori: **W** bianco **R** rosso **Y** giallo **A** arancione **B** blu **G** verde

- 1 ELE25** - elmetto con bardatura interna (fornita smontata)
- ELS25** - sottogola regolabile in tessuto
- 2 APB305** - solo telaio in alluminio, molla per aggancio ai più diffusi tipi di elmetto. A norma EN166 B 3
- 3 APB302** - solo telaio in policarbonato, fascia elastica per aggancio ai più diffusi tipi di elmetto. A norma EN166 B 3 9
- APB312** - solo schermo per l'utilizzo con i telai APB305 o APB302 in policarbonato incolore, spessore mm 1, a norma EN166 1B 3 9



4 ELMETTO ANTINCENDIO HPS® SAFEGUARD



Dräger HPS® SafeGuard è un elmetto universale che grazie al suo peso ridotto è la soluzione ideale durante le operazioni antincendio e di soccorso prolungate senza protezione respiratoria. Può essere adattato alle diverse misure della testa (da 50 a 64/66 cm) grazie alla rotella posta sulla calotta dell'elmetto. Bardatura a 3 punti di fissaggio con cinghie nuca e sottogola regolabili. Bande rifrangenti. A richiesta fornibile torcia a LED integrata 3W ad alto rendimento. Peso 1,2 kg. Omologazione CE per conformità alle norme EN443:2008 (type A 3b, C, E2, E3, -30°C) - EN14458:2018 (visiere per elmetti di protezione) - EN16471:2014 (lotta contro incendi boschivi/di vegetazione) - EN16473:2014 (soccorso tecnico).

RSD1621 - elmetto HPS SafeGuard completo di visiera retrattile. Colori: **W** bianco **R** rosso **Y** giallo fluo **L** luminescente

RSD1622 - elmetto HPS SafeGuard Extend completo di paranuca e visiera + occhiale retrattili. Colori: **R** rosso **Y** giallo fluo **L** luminescente



FORI LATERALI RICHIUDIBILI



5 ELMETTI SUPER BOSS



Elmetto in polietilene, fori laterali richiudibili. Bardatura in plastica a 6 cardini con fascia antisudore in pelle sintetica. Misura 52-61 cm. Resistente alle basse temperature (-20°C). A norma EN397. Colori: **W** bianco **Y** giallo **B** blu

- ELE08** - elmetto in polietilene, peso gr 359.
- ELF11** - fascia antisudore per elmetti SUPER BOSS (ELE08.)
- ELS11** - sottogola in pelle per ELE08, ELE13Y ed ELE14

6 VISIERE PER ELMETTI SUPER BOSS



Visiere incolore ribaltabili montate su telaio, compatibili con elmetti ELE08. Schermi di ricambio fornibili a richiesta. Dimensioni: mm 540 x 195.

APU9721 - visiera in acetato antiappannante. Peso gr 218, spessore mm 1. Conforme alle norme: EN166 - EN167 - EN168 1F 3

APU9723 - visiera in policarbonato. Peso gr 205, spessore mm 1,5. A norma: EN166 3-1,2 1B 3



VERSIONE PER EDILIZIA CON TESA CORTA

ELMETTI PHEOS



Massima sicurezza e comoda vestibilità sono i segni distintivi degli elmetti protettivi della serie Pheos. Elmetto in polietilene dal design sportivo, con tre prese d'aria regolabili per la massima areazione. Bardatura interna con sistema di regolazione graduale a rotella, visiera corta per un campo visivo più ampio verso l'alto. A norma EN 397 e requisiti supplementari per temperature molto basse (-30°C) e spruzzi di metallo fuso (MM = "Molten Metal"). Colori: **W** bianco **R** rosso **Y** giallo

- 7 ELE131Y** - elmetto per edilizia con tesa corta, colore giallo
- 8 ELE141** - elmetto con tesa standard, peso 400 g

9 VISIERE PER ELMETTI PHEOS



In materiale plastico estremamente leggero, con adattatore per elmetti Pheos. Guida regolabile in lunghezza per adattare le visiere (possono essere bloccate in 3 posizioni). Schermi di ricambio fornibili a richiesta. Dimensioni: mm 540 x 195.

APU9725 - visiera in acetato antiappannante. Peso gr 182 spessore mm 1. Conforme alle norme EN166 - EN167 - EN168 - EN170 1F 3-1,2

APU9726 - visiera in policarbonato. Peso gr 218 spessore mm 1,5. Conforme alle norme EN166 - EN167 - EN168 - EN170 1B 2-1,2



1



2



ELMETTO, VISIERA
E CUFFIE DIELETTRICHE
A PAGINA 370.

1 3M™ PELTOR™ G2000 CON UVICATOR™

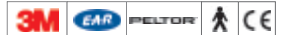

Elmetto ventilato in ABS, stabilizzato raggi UV con bardatura in plastica e fascia antisudore. Resistenza termica da + 50 °C a - 30 °C, deformazione laterale, metallo fuso (MM). Il modello è dotato di un indicatore di usura: rimane rosso fino a che può essere utilizzato. Peso 340 g. Misura cm 54-62. A norma EN397.

2 3M™ PELTOR™ G3000 CON UVICATOR™



Stesse caratteristiche del G2000, ma con un maggior numero di fori per una massima aerazione, divisoria più corta per migliorare la visibilità, forma arrotondata che riduce il rischio di impigliamento, rivestimento reversibile (può essere ruotato di 180° per portare l'elmetto davanti-dietro: utile, ad esempio, per passare in spazi stretti o per le risalite). Peso: 310 g. Misura cm 54-62. A norma EN397. **Il modello Hi-Viz offre agli utenti una maggiore visibilità.**

ELE15. - elmetto ventilato 3M™ Peltor™ G2000 con Uvicator™. Colori: **W** bianco **R** rosso **Y** giallo. Altri colori a richiesta

ELE16. - elmetto ventilato 3M™ Peltor™ G3000 con Uvicator™.

Colori: **H** Hi-Viz **W** bianco **R** rosso **Y** giallo **A** arancione **B** azzurro

ELE17W - elmetto G3001 non ventilato, colore bianco. **Dielettrico** **1000V**. A norma EN50365. Compatibile con visiera dielettrica APU9714 (pagina 370)



3



6



3 SET CUFFIA, ELMETTO E VISIERA



Composto da:

ELE16. - elmetto Peltor™ G3000 (vedi colori disponibili)

TV116 - visiera V4FK per elmetti ELE16.

APH513 - cuffia Optime™ I per elmetti Peltor™ G3000 (codice ELE16.)

6 KIT FORESTALE



Elmetto resistente, ultra leggero, ventilato, completo di visiera a rete e cuffie auricolari. Elmetto in ABS con bardatura tessile a 6 punti, misura cm 51-63, fascia antisudore Hydro-Flock in spugna 4 mm a norma EN 397. Visiera in rete metallica rivestita in nylon, mm 170, a norma EN 1731.

ELE63 - kit forestale elmetto, visiera, cuffie

Attenuazione (in dB): H=29 M=22 L=15 SNR=25



FORNIBILI A RICHIESTA VISIERE RETATE.

ALTRI ARTICOLI PER VIGILI DEL FUOCO (GUANTI, STIVALI, ABBIGLIAMENTO) ALLE PAGINE 382, 406 E 467.



7



CLIP PER AGGANCCIO TORCIA



FORNIBILE ANCHE IN GIALLO

VISIERE 3M™ PELTOR™ V4



Visiere in policarbonato chiaro di alta qualità, estremamente resistenti a urti e graffi. Temperatura di utilizzo: -40°C +130°C. Con attacchi per cuffie Peltor™ e, tramite attacchi aggiuntivi, anche per elmetti Peltor™. Spessore mm 1, peso 110 g. A norma EN166 1F. Altre visiere fornibili a richiesta.

4 TV115 - visiera V4F per elmetto ELE15.

5 TV116 - visiera V4FK per elmetti ELE16.

TV216 - attacco visiera elmetto ELE16. - ELE17W. senza parti metalliche

TV315 - attacco visiera elmetto ELE15.

ACCESSORI PER ELMETTI



ELS16 - cinturino sottogola in nylon per elmetti Peltor G3000

ELF16 - fascia antisudore in pelle per tutti gli elmetti Peltor

7 ELMETTO ANTINCENDIO V.V.F.



Calotta in poliammide ignifugo rinforzato con fibre di vetro (massima resistenza meccanica e termica). Cinghiaggi di regolazione interni in NOMEX®, superfici interne di contatto rivestite in pelle, calotta interna SHOCK-ABSORBING in poliuretano. Semplice da indossare, adattabile mediante sistema di regolazione a rotella (circonferenza della taglia variabile da 54 a 62 cm). Inclusi sottogola, paranuca in tessuto ignifugo e 2 visiere di protezione (visore panoramico dorato e visore ad occhiale), retrattili a scomparsa all'interno del casco. Visiere in policarbonato resistente alle fiamme e agli agenti chimici. A norma EN 443:2008, EN166:2001, EN 14458:2004, EN171:2002.

Dispositivo di protezione di III categoria.

ELV031. - elmetto antincendio per V.V.F., peso 1,57 kg.

Colori: **R** rosso **Y** giallo

ELN031A - protezione nucale alluminizzata (opzionale) per elmetti ELV031



PROTEZIONE DEL CAPO E DEL VISO



1 ELE119.
elmetto dielettrico Pheos

2 APU0078
adattatore per
visiera dielettrica

3 APU6006
visiera dielettrica

4 APU0215
cuffie dielettriche Pheos

SET DIELETTICO PHEOS: ELMETTO, VISIERA E CUFFIE



Set composto da:

- 1 ELE119.** - elmetto protettivo dal design sportivo. Massimo comfort, bardatura interna con sistema di regolazione graduale a rotella, tre prese d'aria regolabili, visiera corta per un campo visivo più ampio verso l'alto. Certificata EN50365 (1.000 Volt CA) per le applicazioni in ambito elettrico. A norma EN397 e requisiti supplementari per temperature molto basse (-30 °C) e spruzzi di metallo fuso (MM = "Molten Metal"). Colori: **W** bianco **Y** giallo
- 2 APU0078** - adattatore per visiera magnetico combinabile con gli elmetti Pheos e le cuffie anti rumore Pheos K2P con sistema di aggancio magnetico
- 3 APU6006** - visiera in policarbonato antiappannante e antigraffio, con rivestimento Supravisation Excellence. Due versioni di fissaggio: braccio per aggancio meccanico o magnetico. Sistema snodato ergonomico per la distribuzione del peso
- 4 APU0215** - cuffie dielettriche Pheos K2P. Aggancio magnetico all'elmetto, comfort eccezionale grazie ai cuscinetti in memory foam extra morbido, anche in caso di utilizzo prolungato. Rotazione a 360 gradi per le modalità "pronto all'uso" e "riposo". A norma EN 352-3. Attenuazione (in dB): H=35 M=27 L=20 SNR=30



5



VISIERE PER
SEMICALOTTA
A PAGINA 379.

5 VISIERA IN ACETATO DIELETTICA



In acetato trasparente 3-1,2 antiappannante, spessore mm 1,5, a norma EN166, EN167, EN168 EN170 1F 38. Ideale per l'utilizzo con gli elmetti dielettrici ELE9. ed ELE17W **senza l'uso delle cuffie dielettriche.**

APU9714 - visiera dielettrica completa di attacchi



6

6 ELMETTO ISOLANTE CON VISIERA INTEGRATA



Viso completamente protetto grazie all'ampiezza della visiera a scomparsa: facile da manovrare con i guanti isolanti, consente l'utilizzo di occhiali e previene l'appannamento. Schermo di qualità ottica classe 1 per una migliore visione durante le attività di lavoro prolungate. Bardatura a 4 punti regolabile tramite rondella, fibbia automatica sottogola. A norma EN 397:2012 + A1, EN 50365:2002, EN 166:2001, EN 170:2001, marcatura visiera EN 166: 2001 3-1,2 1 AT S 3 4 8 9 KN. Protezione da arco elettrico (Classe I). Peso 780 g.

ELE43WR - elmetto isolante con sacca richiudibile in dotazione



7



7 ALLARME PERSONALE



Offre un livello di sicurezza ulteriore ai lavoratori che operano in ambiente elettrico. L'allarme acustico aumenta in base all'intensità del campo elettrico rilevato. Fornito con kit di adattatori (3x), fascia elastica, custodia, caricabatterie e cavo USB. **A norma EN61000-6-2, EN 61000-6-4.**

EAC65 - dispositivo rilevazione di tensione individuale con lampada, peso gr 98, IP65



8

8 CAPPELLINO DI SICUREZZA



Calotta interna in polipropilene. Imbottitura interna, tessuto assorbente. Inserti retroriflettenti ad alta visibilità. A norma EN812.

ELCH090 - cappellino di sicurezza, peso 180 g



9

9 CAPPELLINO DI SICUREZZA



Calotta interna, massima flessibilità e adattabilità. Imbottitura interna, tessuto assorbente in pile a rete traspirante. A norma EN812.

ELC430 - cappellino di sicurezza EN812



10



11

ACCESSORI SOTTO ELMETTI



10 TCK04 - sottocasco in TNT con elastico, 100% polipropilene 40 g/m². **Confezione 100 pezzi.** Taglia unica. DPI di 1^a categoria.

11 ELC010 - berretta sottocasco in maglia. Composizione: 50% lana, 50% acrilico. Minimo ordinabile 10 pezzi/multipli.



1 TORCIA PER ELMETTI RICARICABILE



Torcia **certificata ATEX** in alluminio di grado aeronautico con 4 modalità di illuminazione: stroboscopica, alta, media e bassa intensità. Ricarica USB. 1000 Lumen. Cinturino elastico. **IP-X7 impermeabile.**

TNI708 - torcia per elmetti lunghezza 178 mm, peso gr 173, autonomia 2 ore ad alta intensità, 6 ore a bassa intensità



4 DIVERSE MODALITÀ DI ILLUMINAZIONE



3 DIVERSE MODALITÀ DI ILLUMINAZIONE

2 TORCIA PER ELMETTI



Con **doppia fascia in caucciù per elmetto e in tessuto per la testa.** Autonomia 15 ore. Funziona con 3 batterie AAA incluse. Lente in policarbonato antigraffio. Testa inclinabile, dotata di interruttore singolo sopra la torcia per selezionare 3 diverse modalità di illuminazione (compresa Dual-Light™), distanza del raggio fino a 19 metri. Certificata IP-X7. 30 Lumen.

TNI602 - torcia per elmetti a led, lunghezza 48 mm, peso gr 104 con batterie

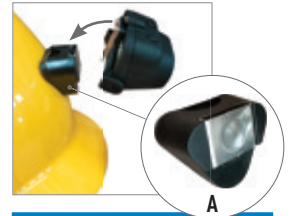

5 DIVERSE MODALITÀ DI ILLUMINAZIONE

3 TORCIA PER ELMETTI



Con **clip in acciaio (integrata) adesiva per elmetto (A).** Autonomia da 5 a 14 ore. Funziona con 3 batterie AAA incluse. Lente in policarbonato antigraffio. Testa inclinabile, dotata di doppio interruttore sopra la torcia per selezionare 5 diverse modalità di illuminazione (compresa Dual-Light™), distanza del raggio fino a 158 metri. Certificata IP-X7. 180 Lumen.

TNI608 - torcia per elmetti, lunghezza 53 mm, peso gr 94 con batterie



5 DIVERSE MODALITÀ DI ILLUMINAZIONE

4 TORCIA FRONTALE LED 2 IN 1 RICARICABILE



5 modalità di luce: striscia COB alta (350 Lumen), striscia COB bassa, luce laterale alta, luce laterale bassa, strobo. Luce 2 in 1: Illuminazione dell'intera area e illuminazione a lunga distanza. Il sensore permette di accendere/spgnere la luce senza toccarla. Autonomia 5 ore. Ricaricabile tramite USB.

LR524 - torcia frontale ricaricabile mm 205 x 200 x 40, peso gr 80



3 DIVERSE MODALITÀ DI ILLUMINAZIONE

5 LAMPADA DA TESTA RICARICABILE



3 modalità di luce: 100% (300 Lumen, autonomia 3 ore), 50% (150 Lumen, autonomia 7 ore), 15% (autonomia 14 ore). Manopola dimmer e sensore che permette di accendere/spgnere la luce senza toccarla. Portata 10 metri. Ricaricabile tramite USB, tempo di ricarica 3 ore. Dimensioni 80 x 60 x 40 mm.

LR207 - lampada da testa ricaricabile, peso gr 140



7 DIVERSE MODALITÀ DI ILLUMINAZIONE

6 LAMPADA DA TESTA RICARICABILE



7 modalità di luce: 100% (900 Lumen), 40%, 15%, 2%, strobo, luce rossa fissa o lampeggiante. Manopola dimmer e sensore che permette di accendere/spgnere la luce senza toccarla. Portata fino a 120 metri. Ricaricabile tramite USB. Potenza 10W. Impermeabile IPX4. Dimensioni 170 x 170 x 50 mm.

LR201 - lampada da testa, peso gr 136



3 DIVERSE MODALITÀ DI ILLUMINAZIONE

7 TORCIA DA TESTA CON FASCIA DOPPIA



Torcia da testa in ABS, orientabile in senso verticale. Ideale per utilizzo professionale, nel campo dell'industria. Con fascia elastica regolabile, 1 LED da 1 Watt, portata 30 m, 40 Lumen. 3 modalità di luce: 100%, 50%, flash) Autonomia 10 ore. Confezione in blister. 3 batterie AAA (non incluse).

ESV510 - torcia da testa mm 43 x 93 x 43, peso gr 150

PROTEZIONE OCCHI E VISO: LE NORME, COME PROTEGGERSI

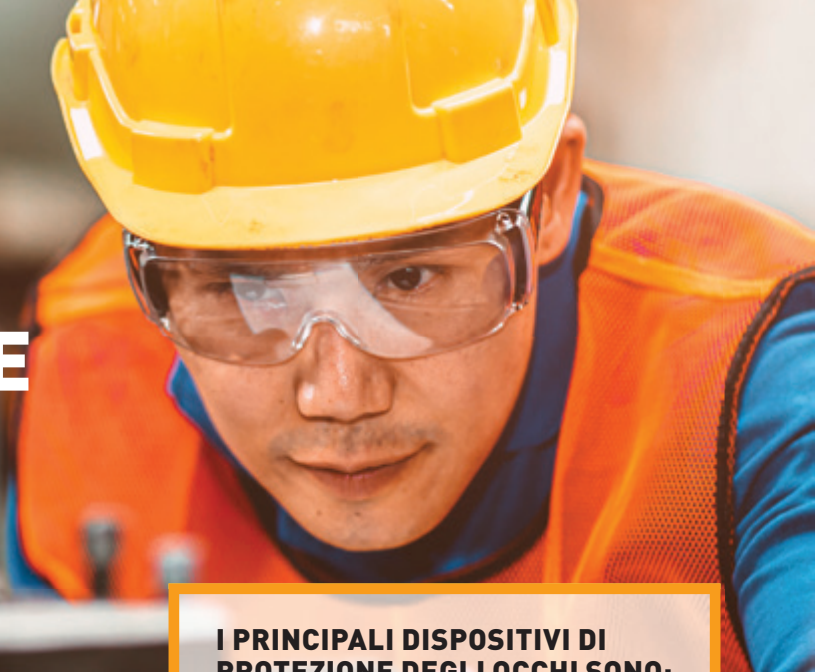

I PRINCIPALI DISPOSITIVI DI PROTEZIONE DEGLI OCCHI SONO:

- Occhiali a stanghetta
- Occhiale a mascherina ad elastico
- Visiere a casco
- Schermi a mano
- Maschere a casco

L'occhio è un organo delicato, che deve essere protetto da rischi meccanici ed ottici. I casi in cui devono essere usati i dispositivi di protezione degli occhi sono:

- Rischi meccanici (polvere a grana grossa e fine, particelle ad alta velocità, corpi incandescenti e metalli fusi)
- Rischi ottici (raggi nocivi derivanti dalla saldatura o taglio alla fiamma oppure elettrica)
- Rischi chimici (gas, spruzzi o gocce di soluzioni chimiche)

RIFERIMENTI LEGISLATIVI

EN165: Terminologia

EN166: Requisiti dei DPI - specifiche

EN167: Collaudi ottici

EN168: Collaudi non ottici

EN169: Filtri per saldatura e tecniche simili. Requisiti di trasmissione ed uso consigliato

EN170: Filtri di raggi ultravioletti. Requisiti di trasmissione ed uso consigliato

EN171: Filtri di raggi infrarossi. Requisiti di trasmissione ed uso consigliato

EN172: Filtri solari per uso industriale

EN175: Protezione durante le operazioni di saldatura o processi similari

EN207: Filtri e protezione degli occhi contro i raggi laser

EN208: Occhiali per lavori di aggiustamento a laser

EN379: Protezione personale degli occhi - Specifiche per filtri di saldatura automatici

EN1731: Protezione personale degli occhi - Protettori degli occhi e del viso a rete



CARATTERISTICHE TECNICHE E CLASSIFICAZIONE

I DPI devono essere adottati in base al tipo di lavoro da eseguire. In generale:

- **Saldatura e/o taglio alla fiamma:** occhiali a stanghetta o a mascherina con lenti verdi/grigie inattiniche con livello di protezione da 1,7 a 8.
- **Saldatura e/o taglio ad arco elettrico:** schermi a mano o maschere a casco con lastre verdi inattiniche con livello di protezione da 9 a 14
- **Protezione contro rischi meccanici:** occhiale a stanghetta o a mascherina con lenti incolore in policarbonato
- **Protezione contro polvere/liquidi:** occhiale a mascherina con lente incolore e sistema di areazione che non permette la penetrazione di polvere e/o liquidi

VARIANTI COLORI DELLE LENTI

COLORELENTE	DESCRIZIONE	NORME
Chiara	Massima trasmittanza	EN166 - EN170
Chiara specchiata	Adatta in condizioni di illuminazioni alternate	EN166 - EN172
Azzurra	Riduce l'affaticamento oculare	EN166 - EN170
Gialla	Aumenta il contrasto in caso di scarsa visibilità	EN166 - EN170
Marrone	In condizioni di luce solare e di abbagliamento	EN166 - EN172
Grigio Fumo	Buon riconoscimento dei colori	EN166 - EN172
Blu IR	Protezione contro raggi IR	EN166 - EN171
Verde IR	Specifico per la saldatura	EN166 - EN169
Grigia	Radiazioni IR e UV con percezione perfetta del colore	EN166 - EN169

ESEMPI DI MARCATURA

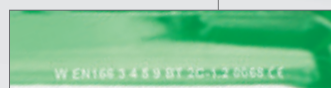
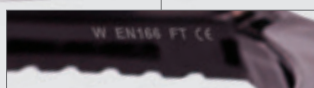
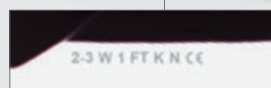

MARCATURA SULLA LENTE	
2 - 3	Numero di scala (n. codice + n. gradazione)
W	Produttore
1	Classe ottica
FT	Resistenza meccanica
KN	Requisiti aggiuntivi

MARCATURA SULLA MONTATURA	
W	Produttore
EN166	Norma
FT	Resistenza meccanica

MARCATURA SULLA MONTATURA	
W	Produttore
EN166	Norma
3 4 5 9	Campi di impiego
BT	Resistenza meccanica
2C-1.2	Filtro compatibile con la montatura
0068	ID Ente notificato (DPI IIIª categoria)

MARCATURA SULLA LENTE	
2C-1.2	Numero di scala (n. codice + n. gradazione)
W	Produttore
1	Classe ottica
BT	Resistenza meccanica
9	Campi di impiego
KN	Requisiti aggiuntivi
0068	ID Ente notificato (DPI IIIª categoria)

NORMA EN 166

TIPO DI FILTRO

Filtro per ultravioletti con effetti sull'identificazione dei colori
Filtro per ultravioletti con buona identificazione dei colori
Filtri per infrarossi
Filtri per radiazioni solari senza specifiche
Filtri per radiazioni solari con specifica per infrarossi

CLASSE OTTICA

Tolleranza potere rifrattivo $\pm 0,06$
Tolleranza potere rifrattivo $\pm 0,12$
Tolleranza potere rifrattivo $\pm 0,25$

RESISTENZA MECCANICA

Robustezza incrementata 12 m/s - 43 km/h
Impatto a bassa energia 45 m/s - 162 km/h
Impatto a media energia 120 m/s - 432 km/h
Impatto ad alta energia 190 m/s - 684 km/h

CAMPI DI UTILIZZO

Liquidi/gocce/spruzzi
Particelle solide grossolane
Gas/particelle solide fini
Archi elettrici da cortocircuiti
Metalli fusi/solidi incandescenti

PREREQUISITI OPZIONALI

Resistenza all'abrasione
Resistenza all'appannamento
Resistenza all'impatto a temperature estreme (-5°/+55°C)
Riflettanza incrementata nell'infrarosso

MARCATURE

MONTATURA O SUPPORTO	LENTI
	2 + gradazione
	3 + gradazione
	4 + gradazione
	5 + gradazione
	6 + gradazione
	S
F (T*)	F (T*)
B (T*)	B (T*)
A (T*)	A (T*)
3	-
4	-
5	-
8	-
9	9
	K
	N
	T
	R

TIPI DI PROTETTORE

OCCHIALI	OCCHIALI A MASCHERINA	VISIERE
X	X	X
X	X	X
X	X	X
X	X	X
X	X	X
X	X	X
X	X	X
X	X	X
X	X	X
	X	X
	X	X
	X	X
	X	X
X	X	X
X	X	X
X	X	X
X	X	X

* NB: la lettera "T" che segue la resistenza meccanica indica che la montatura resiste all'impatto a temperature estreme (-5°/+55°C).



1 I-GUARD™



Innovativi occhiali protettivi 3 in 1. La montatura flessibile garantisce una migliore protezione, adattandosi alle diverse forme del viso. Ergonomici, proteggono in modo affidabile da liquidi e particelle. Design delle lenti ampio e piatto per un campo visivo senza ostacoli. Lente in policarbonato con tecnologia di rivestimento Uvex Supravision - resistente ai graffi e antiappannante permanente. Le stanghette laterali ergonomiche possono essere inclinate a più livelli, consentendo un elevato livello di personalizzazione per garantire un'ottima vestibilità, senza punti di pressione. Metal-free. Materiale: TPE riciclato, colore antracite. A norma EN166 - EN170.

APU3266 - occhiali protettivi 3 in 1 I-Guard™



2 PURE FIT™



Occhiali di protezione in policarbonato incolore, riciclabili al 100%. Innovativi e confortevoli, si contraddistinguono per l'estrema leggerezza (19 gr). Le stanghette flessibili si adattano perfettamente a qualsiasi forma del viso e garantiscono una tenuta sicura, senza punti di pressione. Lente in policarbonato con tecnologia di rivestimento Uvex Supravision - resistente ai graffi e antiappannante permanente, senza montatura, per un ampio campo visivo. UV400 - 100% di protezione da pericolose radiazioni UVA e UVB fino a 400 nm. Metal-free. a norma EN166 - EN170.

APU5265 - occhiali incolore Pure Fit™



3 PHEOS 9192



Inclinazione nella parte superiore della lente per una maggiore protezione delle sopracciglia. Lente panoramica, stanghette in morbido terminale. Lente in policarbonato antigraffio esternamente, antiappannante internamente. Peso gr 30.

- 3 APU2225** - stanghette nero/lime, lente incolore 2-1,2 (1F EN166 - EN170)
- 4 APU2245** - stanghette nero/arancio, lente grigia 5-2,5 (1F EN166 - EN172)
- 5 APU2385** - stanghettenero/giallo, lente gialla 2-1,2 (1F EN166 - EN170)
- 6 APU2881** - stanghette grige, lente specchiata 5-1,7 (1F EN166 - EN172)



7 PHEOS SMALL 9192



Modello Pheos 9192 studiato per adattarsi a visi più piccoli. Inclinazione nella parte superiore della lente per una maggiore protezione delle sopracciglia. Stanghette in morbido terminale. Lente panoramica, per un ampio campo visivo, in policarbonato antigraffio esternamente, antiappannante internamente. Peso gr 28.

- 7 APU2725** - stanghette lime, lente incolore 2-1,2 (1F EN166 - EN170)
- 8 APU2745** - stanghette arancioni, lente grigia 5-2,5 (1F KN EN166 - EN172)



X-FIT



Occhiale protettivo leggero (peso gr 23) con lente in policarbonato. Montatura in ABS, stanghette con chiusura a cerniera. Metal free. Lenti antiappannanti all'interno, resistenti all'abrasione e alle sostanze chimiche all'esterno. A norma EN166 e EN170 1 FT K N.

- 9 APU9192** - montatura grigio translucido, lente grigia 23% 5-2,5
- 10 APU9191** - montatura azzurro translucido, lente incolore 2C 1,2



1 SUPER F OTG 9169



Sovracchiale ultra leggero, ripari laterali integrati, ampio campo visivo. Stanghette ultra morbide per una perfetta adattabilità. Lente in policarbonato antigraffio. Peso gr 37. Conforme alle norme EN166 e EN170 1F.

1 **APU6964** - montatura nera, lente in policarbonato colore marrone chiaro 65% 2C-1,2 (W1 FTKN EN 166 - EN 170)

2 **APU9585** - montatura nera, lente incolore 2-1,2, elevata resistenza all'abrasione e prodotti chimici



3 SKYLITE



Occhiali protettivi (monoculare) con lenti grigie per una protezione impeccabile contro i raggi UV. Protezione antiriflesso opacizzata, protezione sopraccigliare e laterale integrata stanghette blu con inclinazione regolabile, rivestimento antigraffio di alta qualità. Pratici da indossare, consigliati in caso di pericoli derivanti da particelle in proiezione, ideali per proteggere gli occhi da polvere e schegge. Conforme alle norme EN166-168, EN 170/172;1F. Peso gr 27.

APU9177 - lente grigia antigraffio, filtro solare 5-2,5



4 VISITOR 9161

STANGHETTE CON MORBIDO TERMINALE DUO-FLEX®



Occhiale protettivo con lente in policarbonato. Stanghette regolabili in inclinazione e lunghezza. Consigliato come sovracchiale. Peso gr 47. Conforme alla norma EN166 1F.

APU9160 - lente incolore antigraffio, stanghette non regolabili, senza terminale Duo-flex®

APU9161 - lente incolore antigraffio, stanghette con terminale Duo-flex®, elevata resistenza all'abrasione e prodotti chimici

APU9162 - lente incolore antiappannante antigraffio, antistatica, stanghette con terminale Duo-flex®



5 I-5



Occhiali protettivi dal design sportivo Premium. Robusta lente incolore in policarbonato, resistente ai graffi. Le stanghette ergonomiche con regolazione dell'inclinazione e della lunghezza a più livelli consentono un elevato livello di personalizzazione e garantiscono una buona vestibilità per tutte le forme della testa e del viso. Le estremità morbide garantiscono una tenuta comoda e sicura, senza punti di pressione. Il nasello morbido e flessibile si adatta a chi indossa gli occhiali e garantisce una vestibilità antiscivolo e senza pressione. Metal-free. Montatura colore antracite/blu. Conforme alle norme EN166 e EN170 1F. UV400 - 100% di protezione da pericolose radiazioni UVA e UVB fino a 400 nm.

APU3065 - occhiali protettivi I-5, marcatura: W 166 FT CE - 2C-1,2 W1 FTK CE



7 SKYGUARD 9175



Design ergonomico, ripari laterali e sopraccigliari integrati. Bardatura in elastomero sintetico per una più completa protezione da liquidi spruzzi e particelle polvere. Stanghette regolabili in inclinazione. Lenti in policarbonato antigraffio esternamente antiappannanti internamente. Peso gr 40. Conforme alle norme EN166 e EN170 1 F 3 4.

APU9275 - montatura grigio/arancio, lente incolore 2-1,2



9

10

SPORTSTYLE 9193



Leggeri (23 gr), design sportivo, ponte nasale regolabile, lente in policarbonato trasparente antigraffio all'esterno, antiappannante all'interno. Conforme alle norme EN166 e EN170 1 F TKN.

9 **APU3376** - stanghette nero/azzurro con terminali morbidi, lente incolore 2-1,2 antigraffio e antiappannante

10 **APU3280** - stanghette bianco/nero con terminali morbidi, lente grigia filtro solare 5-2,5 antigraffio e antiappannante.



8 METEOR



Con lenti in policarbonato. Stanghette regolabili in lunghezza, elevata resistenza all'abrasione e prodotti chimici. Conforme alla norma EN166 1F.

APU9105 - lente incolore 2-1,2



1 PHEOS CX2



Occhiale protettivo con lenti in policarbonato. Montatura in POM-TPE, parti morbide nelle zone di contatto (stanghette, fronte e nasello integrato). Stanghette sottili per un comodo utilizzo con altri DPI. Peso 28 gr. La versione con lente CBR65 abbatte la luce blu ed è consigliata per utilizzo durante attività in interno o esterno. Conforme alla norma EN166 e EN170 1 FT K N.

1 **APU9197** - montatura bianco/nero, lente marrone chiaro (CBR 65) 5 - 1,4 EN 172

2 **APU9196** - montatura nero/celeste, lente incolore 2C 1,2



3 I-VO



Occhiale protettivo con lenti in policarbonato resistente all'abrasione e ai prodotti chimici. Quattro cuscinetti su ogni stanghetta, regolabile in inclinazione e lunghezza. Peso gr 37. Conforme alla norma EN166 1F.

3 **APU9155** - lente incolore 2-1,2 antiappannante

4 **APU9156** - lente grigia 5-2,5 (EN172), elevata resistenza all'abrasione e prodotti chimici



5 ULTRAVISION ANTIGAS



Mascherina con lenti in policarbonato incolore, antiappannante, antigraffio. Telaio in TPU rosso autoestinguente, completamente chiuso per utilizzo in presenza di gas. Per industria chimica, squadre antincendio, e pronto intervento forestale. Certificato per liquidi, polveri, gas, metalli fusi e corpi ardenti. A norma EN166, EN168 e EN170 1B 3459KN.

APU9301 - occhiale a mascherina Ultravision antigas, peso gr 128



6 MEGASONIC



Occhiali a mascherina con campo visivo ottimizzato (+ 20% di campo visivo). Lenti in policarbonato trasparente. Lenti interne antiappannanti, lenti esterne con elevate proprietà antigraffio e resistenti alle sostanze chimiche. A norma EN 166 e EN 170 (filtro UV).

APU9320 - occhiale a mascherina con fascia elastica



7 ULTRASONIC



Mascherina con lenti in policarbonato incolore antiappannante, antigraffio. Idoneo per chi porta occhiali correttivi. Morbido telaio in PP e TPE, ideale contro gli urti, liquidi, polveri, metalli fusi. Peso gr 80. A norma EN166, EN167 e EN168 1B 349KN.

APU9302 - occhiale a mascherina con banda elastica sintetica regolabile

A RICHIESTA VERSIONE AUTOCLAVABILE PER CAMERE BIANCHE.



9 ULTRAVISION



Mascherina con lenti in acetato incolore antiappannante per rischi chimici. Morbido telaio in PVC idoneo per chi porta occhiali correttivi. Peso gr 119. A norma EN166 1F 34N.

APU9314 - occhiale a mascherina



8 CARBONVISION 9307



Occhiale a mascherina leggerissimo (solo gr 42). Perfetta aderenza al viso, banda elastica di alta qualità e lunga durata. Comoda clip per rimozione della banda elastica prima della pulizia. Il profilo sottile dell'occhiale lo rende **particolarmente adatto per l'utilizzo con visiere**. A norma EN166 e EN170 1B 3 4.

APU7375 - montatura grigio/nera, lente policarbonato incolore 2-1,2 antiappannante





1



2



3

SECUREFIT 400X



Occhiale protettivo con lenti in policarbonato e rivestimento antiappannamento con resistenza maggiore rispetto ai rivestimenti tradizionali. Protezione aggiuntiva sopraccigliare morbida e sagomata. Tecnologia brevettata "Pressure Diffusion Temple" che permette di distribuire in modo uniforme la pressione sulle tempie per una vestibilità sicura e confortevole. Nasello morbido antiscivolo. A norma EN166. A richiesta fornibili con lente colore giallo e vermiglio (arancio).

1 AP8222 - montatura blu/grigia, lente incolore a norma EN170 2 - 1,2 1 F(T) KN

2 AP8223 - montatura blu/grigia, lente grigia a norma EN172 5-3,1 1 F(T) KN

3 AP8224 - montatura blu/grigia, lente grigia auto oscurante (interno/esterno) a norma EN172 5 - 1,7 1 F(T) KN



4

4 SECUREFIT 600™



Occhiale protettivo con lenti trasparenti in policarbonato, antiappannante e antigraffio. Tecnologia brevettata "Pressure Diffusion Temple", permette l'adattamento alle diverse forme del capo esercitando una pressione uniforme nella zona temporale. Nasello morbido antiscivolo. Peso 27 g. A norma EN166, EN170 2C-1.2 3M 1 FT K.

AP8221 - montatura grigia, lente incolore



5

SOLUS 2000™



Occhiale protettivo con lenti in policarbonato, antiappannante e antigraffio. Montatura sottile che avvolge le lenti solo nella parte superiore e stanghette con sistema pivotante a più livelli di regolazione che consente di adattare le lenti alle caratteristiche del volto e alla posizione degli occhiali. A norma EN 166, 2C-1.2 3M 1 FT K N

5 AP8817 - montatura grigio/rosso, lente incolore

6 AP9600 - montatura grigio/rosso, lente grigia



6



7

VIRTUA™/TORA™



Occhiale protettivo monolente in policarbonato a protezione da impatti. Modello Virtua: lenti antigraffio, astine piatte leggere e avvolgenti, dotato di protezione sopraccigliare. Modello Tora: lenti antigraffio, antiappannante, ripari sopraccigliari trasparenti e integrati, dotati di cordino regolabile e facilmente rimovibile. A norma EN166, EN170 2-1,2 1FT.

7 AP8150 - Virtua, lente chiara antigraffio

8 AP8151 - Tora, lente chiara antiappannante



9

9 SOLUS 1000™



Occhiale protettivo con lenti trasparenti in policarbonato che assorbe il 99,9% dei raggi UVA-UVB, antiappannante e antigraffio. Montatura sottile, stanghette in materiale morbido, con imbottitura interna. Inserto in schiuma rimovibile che riduce l'esposizione al rischio di particolato. A norma EN 166, 2C-1.2 3M 1 FT K N.

AP8882 - montatura verde/nera, lente incolore



OCCHIALI SENZA PARTI METALLICHE A PAGINA 428.



8



10

10 VISITOR™



Occhiali protettivi monolente interamente in policarbonato incolore, resistenti agli urti, avvolgenti, con ripari laterali e fori. Comodi e leggeri, adatti come sovraocchiale per operatori o visitatori che portano occhiali graduati.

AP8160 - Visitor, monolente incolore, a norma EN166 2-1,2 1F

APU002C - CORDINO PER TUTTI I MODELLI DI OCCHIALI





PROTEZIONE DEGLI OCCHI



1



2



GEAR SERIE 500

Occhiali a mascherina con trattamento antiappannamento superiore, progettato per utilizzo in situazioni di condizioni caldo/umido, ambienti esterni/interni, attività fisicamente impegnative e aree con clima condizionato. Ideali per la protezione da polveri e schizzi, design dal profilo sottile e cinturino regolabile in tessuto. Insetto per lenti da vista opzionale fornibile a richiesta. A norma EN166 e EN170.

1 **AP8214** - Gear 500, lente incolore 2 - 1,2 1 B(T) KN

2 **AP8218** - Gear 500, lente grigia IR5 a norma EN169 5 1 B KN



3



4



4700/4800

Occhiali a mascherina generici. Disponibili in tre modelli dal design e dal tipo di protezione diversa. Tutti i modelli hanno lente incolore in policarbonato.

3 **AP8147** - modello 3M™ 4800, ventilazione indiretta, lente non trattata, a norma EN166 1B 349

AP8148 - modello come sopra con lente antiappannante, a norma EN166 1B 34

4 **AP8159** - modello 4700, economico con fori di aerazione, a norma EN166 1B



5

5 FAHRENHEIT™



Occhiali a mascherina, versatili e dal peso leggero, con eccellente campo visivo. Lenti in policarbonato antigraffio e antiappannanti. Testati per la protezione da impatti a temperature estreme -5°C +55°C. Confortevole banda elastica.

AP7111 - mascherina Fahrenheit, a norma EN166 1B 34 T



6

ADATTI PER
SALDATURA

6 NEMESIS™



Occhiale per saldatori, lente singola in policarbonato verde IR5, modello con lenti avvolgenti 99,9% protezione UV. Ponte nasale e stanghette in morbido PVC. Applicazioni: saldatura al cannello, alto abbagliamento.

APL5694 - occhiale saldatura lenti verdi IR 5, a norma EN166 1F - EN169



7

7 SUPER F OTG



Occhiale per saldatori, ultraleggero ed utilizzabile anche come sovraocchiale. Lente in policarbonato spessore 21 mm grigia (perfetto riconoscimento dei colori) protezione UV e IR. Trattamento della lente Optidur NCH estremamente resistente ai graffi. Stanghette flessibili. Peso 38 g. A norma EN166 1F(T) K - EN169 - EN172.

APU9543 - lente grigia IR 3

APU9545 - lente grigia IR 5



8

PRATICO FILTRO,
SOLLEVABILE
E SOSTITUIBILE

8 ULTRASONIC FLIP-UP



Occhiale a mascherina con lente fissa in policarbonato chiara UV 2-1,2 B9KN antigraffio sulla superficie esterna e antiappannante sulla superficie interna, lente ribaltina grigia IR5 resistente a proiezioni di schizzi di saldatura (perfetto riconoscimento dei colori). Facile sostituzione della lente grigia (ricambio fornibile a richiesta). A norma EN166 1B349 - EN169 - EN172.

APU2045 - occhiale a mascherina lente flip-up grigia IR5

APU2045R - lente di ricambio grigia IR5



Semicalotte e visiere

Honeywell



1



1 SEMICALOTTA CON VISIERA



Semicalotta in policarbonato con visiera ribaltabile, calotta, protezione mento in policarbonato chiaro, bandatura interna regolabile. Protegge da schizzi e spray, resistente a solventi, acidi e alcali.

APB2140 - semicalotta in policarbonato con visiera



2

2 SEMICALOTTA



Semicalotta in policarbonato con protezione frontale, bardatura nucale regolabile a cremagliera. Bardatura in policarbonato e bardature di poliammide resistenti a numerosi solventi acidi e alcali. Resistenza al calore 125 °C. Peso 220 g.

APB2297 - semicalotta a norma EN166 B-3-9



3



4

VISIERE PER SEMICALOTTA



3 APB312 - visiera in policarbonato incolore, per l'utilizzo con semicalotta APB2297. Spessore mm 1, a norma EN166 1B 3 9

APB2307 - visiera in acetato incolore per l'utilizzo con semicalotta APB2297. Resistenza all'aggressione chimica di numerosi solventi, acidi, alcali, oli e grassi. Spessore mm 1, a norma EN166 1F

4 AP2330 - visiera in policarbonato verde, gradazione I.R. 5.0 per l'utilizzo con semicalotta APB2297. Spessore mm 1, a norma EN166 1F 3

Abbigliamento boscaiolo

Composizione tessuto: 68% poliestere 32% cotone. Colore verde/arancio. La presenza di una fibra ad alta tenacità nelle imbottiture delle parti protette garantisce il blocco istantaneo della catena della sega portatile. A norma EN 381 (per operatori esposti al rischio di taglio con l'utilizzo di seghe a catena portatile).



5



5 GIACCA



Giacca con protezione sul torace, sulle spalle e sulle maniche: Soffietti e ventilazione sulla schiena, chiusura con lampo. Taglie dalla M alla XXXL. A norma EN 381-11.

UTP895 - giacca da boscaiolo colore verde arancio



6



6 STIVALI



Stivale in gomma con puntale e lamina. Protezione da taglio con moto sega sulla tibia e sul metatarso in gomma multistrato. Suola anti derapante. A norma EN ISO 17249+ A1 EN ISO 20345 (P classe 3) SRA. Misure 40 - 47.

ZCI8907 - stivali da boscaiolo verde arancio



7



7 GAMBALI



Protezione sulla parte anteriore della gamba a 180° + 5 cm. Aperture totali laterali sulle gambe a mezzo lampo e lampo centrale che consente di separarli. Passanti in vita. Taglie dalla L alla XXL. A norma EN 381-5.

UTP894 - gambali da boscaiolo colore verde arancio



8



8 PETTORINA



Pettorina con protezione sulla parte anteriore della gamba a 180° + 5 cm. Cintura elastica in vita, bretelle elastiche regolabili con fibbia in plastica, Tasca chiusa con lampo sulla pettorina 2 tasche sul pantalone e tasca posteriore. Taglie dalla M alla XXL. A norma EN 381-5.

UTP893 - pettorina da boscaiolo verde arancio



KIT FORESTALE
A PAGINA 369.



1



ALTRI ARTICOLI
PER LA SALDATURA
ALLE PAGINE 430-431.

1 GIACCA PER LA SALDATURA BEST



Giacca in crosta di alta qualità realizzata con pelle molto flessibile per facilitare i movimenti, con omogeneità di spessore di 1,9 mm. Cuciture in Kevlar, chiusura con bottoni automatici protetti, nessuna parte metallica a contatto con l'esterno. Le maniche nascono dalla base del collo per facilitare i movimenti del braccio. Peso: 13,7g/cm². Colletto in morbido cotone per un maggior comfort al contatto con la pelle dell'operatore, possibilità di chiusura tramite striscia di velcro. Taglie fornibili dalla L alla XXL. *Conforme alla norma: UNI EN 11611:2007 classe 2 A1 + A2.*

TAS2011 - giacca Best per saldatori



2



2 MANICHETTE PER LA SALDATURA BEST



Manichette in crosta marrone con bottoni automatici protetti ai polsi spessore mm 2. Attacco dorsale con stringhe rosse elastiche per facilitare i movimenti. Taglia unica. *Conforme alla norma: UNI EN 11611:2007 classe 2 A1 + A2.*

TAS490 - manichetta per saldatori, lunghezza mm 650



3



3 GREMBIULE PER LA SALDATURA



Grembiule di cuoio con rinforzo ventrale. Cinghie regolabili in vita e al collo con agganci rapidi. Nessuna parte metallica. Protegge il tronco dell'utente durante la saldatura o attività simili. Idoneo per saldatura ad arco. Spessore con rinforzo mm 2,30. Dimensioni cm 90 x 60, peso 650 g. *A norma EN 11611 classe 2 A1+A2.*

TAS220 - grembiule in crosta bovina colore marrone



4

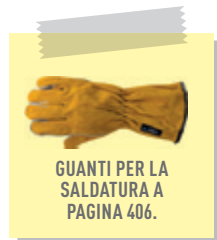

GUANTI PER LA
SALDATURA A
PAGINA 406.

4 GHETTE PER LA SALDATURA BEST



Ghette in crosta marrone e grigia. Ottimo livello delle rifiniture, protezione dello stinco e del collo del piede da spruzzi di metallo fuso e proiezioni, copre e protegge perfettamente la calzatura di sicurezza. Doppia chiusura di velcro regolabile in due posizioni. Due protezioni di rinforzo sullo stinco e sul collo del piede per ammortizzare colpi accidentali. Spessore della pelle 1,4 mm. Altezza 40 cm. Taglia unica. *Conforme alla norma: UNI EN 11611:2007 classe 2 A1 + A2.*

TAS390 - ghette per la saldatura



5



5 SAFE-KNIT® III CATEGORIA



Manichetta da mm 660, prodotta con tessuto **Kevlar®**, con fodera interna di cotone, materiali che rendono il prodotto leggero e ventilato e, al tempo stesso, proteggono dall'elevato calore di scintille e particelle di materiale fuso. Adatta per: operazioni generali di assemblaggio presso impianti di saldatura, manipolazione di metalli in ambienti di lavoro con oggetti molto caldi. Taglia unica.

GE59416 - lunghezza mm 660





1 CAPPUCCIO CON MANTELLA



Cappuccio per la saldatura con trattamento ritardante di fiamma per la saldatura, lunghezza estesa per offrire ulteriore protezione alle spalle, al torace e alla schiena. Si adatta sotto al casco da saldatura. Conforme alle norme: EN 149-3:2004 e EN1149-5:2008 - EN ISO 11612:2008 A B1 C1 - EN ISO 11611:2007 classe 1 A1. Taglia unica.

TAS040 - cappuccio ignifugo per saldatori con mantella



2 CUFFIA GREEN



Cuffia sottocasco per la saldatura in cotone ignifugo Proban®, copricollo, rego-lazione chiusura con velcro ed elastico di tensionamento. CE I categoria. Taglia unica.

TAS805 - cuffia Green per la saldatura



5



6

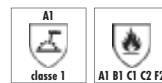

COMPLETO IGNIFUGO PER LA SALDATURA II CATEGORIA



Completo in tessuto 100% cotone ignifugato peso 295 gr/m². con doppie cuciture nei punti di maggior sforzo. Giubbotto ignifugo resistente all'arco elettrico. Collo a camicia, chiusura anteriore con bottoni automatici coperti. Elastico ai polsi, due tasche al petto chiuse con pattina e velcro. Rinforzo sulle spalle. Pantaloni ignifughi, chiusura patta con bottoni coperti, due tasche anteriori a filetto, una tasca posteriore applicata chiusa con pattina e velcro, rinforzo interno al cavallo. A norma: UNI EN ISO 13688:2013; UNI EN ISO 11611:2015; UNI EN ISO 11612:2015. Taglie fornibili dalla 44 alla 58. Colore verde.

5 TASP512. - giacca in tessuto ignifugo

6 TASP513. - pantalone in tessuto ignifugo



3 CUSCINO ISOLANTE PER SALDATURA



Cuscini isolanti per saldatori e per trattamenti termici con pre-riscaldamento, spessore 50 mm. Permettono agli operatori di lavorare in sicurezza anche in prossimità di superfici ad alte temperature, garantendo maggior comfort. Lato superiore che protegge gli utilizzatori impedendo il passaggio di calore, lato a contatto con il pavimento progettato per impedire l'adesione delle scorie incandescenti ai manufatti. Dotati di due maniglie per agevolare il trasporto (A).

CUS100 - cuscino 1000 x 500 mm

CUS050 - cuscino 500 x 500 mm

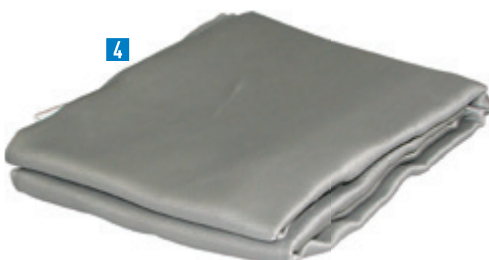

4



4 COPERTE PER LA SALDATURA



Tessuto di Silice Amorfa, finitura inorganica e trattamento antisfilacciamento a base di "Vermiculite".

TAS1092 - dimensioni mm 920 x 1000

TAS1292 - dimensioni mm 920 x 1200



INDUMENTI ANTICALORE ALLUMINIZZATI

SPECIFICHE DEI TESSUTI INDUMENTI ANTICALORE III^A CATEGORIA

Tutti i prodotti della linea alluminizzata TAA... sono realizzati con un nuovo tessuto 50% Para-aramide + 50% Panox 340 gr/m² alluminizzato che, oltre ad avere caratteristiche di alta resistenza al calore e alla fiamma, è estremamente morbido e confortevole. **CERTIFICATI EN ISO 11612 III CATEGORIA.**

EN ISO 11612: A propagazione alla fiamma, B calore convettivo, C calore radiante, D spruzzi di alluminio fuso, E spruzzi di ferro fuso, F calore da contatto.

NB: la norma EN ISO 11612 è solo relativa alla protezione del corpo di lavoratori esposti al calore e alla fiamma ma non comprende ed esclude operazioni come la lotta antincendio trattata nello specifico dalla EN 1486:2008 (vedi nota in basso).



ALTRI ARTICOLI PER VIGILI DEL FUOCO (ELMETTI, STIVALI, GUANTI) ALLE PAGINE 369, 406 E 467.

i A RICHIESTA FORNIBILE COMPLETO PER VIGILI DEL FUOCO A NORMA EN 1486:2008 PER LE OPERAZIONI DI LOTTA CONTRO GLI INCENDI. GLI INDUMENTI EN ISO 11612 NON SONO ADATTI PER QUESTO TIPO DI OPERAZIONI.



1



2



3



4



5

1 GREMBIULE EN ISO 11612 (A1-B1-C3-D3-E3-F2)

Grembiule in tessuto alluminizzato con lacci di sostegno.

TAA1 - grembiule protettivo, dimensioni cm 70 x 100, taglia unica

2 CAPPOTTA EN ISO 11612 (A1-B1-C3-D3-E3-F1)

In tessuto alluminizzato sfoderato. Apertura anteriore con chiusura interna tramite soffietta fermata da Velcro® F.R. e da bandella di protezione chiusa a sua volta con Velcro® F.R. Collo alla coreana, maniche ad ampio giro. Taglie M - L - XL - XXL.

TAA2 - cappotta in tessuto para aramidico

3 GHETTE EN ISO 11612 (A1-B1-C3-D3-E3-F1)

Ghette realizzate in tessuto alluminizzato, chiusura Velcro® F.R. sul retro.

TAA9 - ghette con laccio sotto-scarpa, altezza totale mm 400

4 PANTALONI E GIACCA EN ISO 11612 (A1-B2-C4-D3-E3-F2)

Completo per lavoratori esposti al calore in tessuto alluminizzato coibentato. Taglia M - L - XL - XXL.

4 TAA51P. - pantaloni coibentati con patta anteriore con chiusura a mezzo Velcro® F.R. e bretelle elasticizzate regolabili, apertura a soffietto sul fondo gamba, chiusa a sua volta da Velcro® F.R.

5 TAA51G. - giacca coibentata internamente con compound trapuntato in carbonio e fodera aramidica. Apertura anteriore, chiusura interna tramite soffietta fermata da Velcro® F.R. e da bandella di protezione, chiusa a sua volta da Velcro® F.R., collo alla coreana e maniche ad ampio giro

! LA CERTIFICAZIONE DEL COMPLETO SI RIFERISCE AI CODICI TAA51P + TAA51G + TAA54 + TAA55 + GA5035 UTILIZZATI CONTEMPORANEAMENTE.



6



7



8



ALTRI INDUMENTI ALLUMINIZZATI A PAGINA 480.

9



2543CX



433444

10



7 CAPPUCCIO EN ISO 11612 (A1-B2-C4-D3-E3-F2)

Con visore panoramico in policarbonato dorato, caschetto interno regolabile EN397.

TAA54 - cappuccio coibentato con bretelle, per completi TAA51 e TAA57

6 TUTA ALLUMINIZZATA EN ISO 11612 TIPO 2 (A1-B2-C4-D3-E3-F2)

Tuta alluminizzata coibentata internamente da compound, trapuntato in tessuto ignifugo. Con sacca per alloggiare l'autorespiratore. Taglia M - L - XL - XXL.

TAA57 - solo tuta intera in tessuto con fibra aramidica

8 CALZARI EN ISO 11612 (A1-B2-C4-D3-E3-F2)

Suola 100% in para aramidico e chiusura sul retro tramite Velcro® F.R. Taglia unica.

TAA55 - calzari coibentati per completi TAA51 e TAA57.

9 CALZARI EN ISO 11612 (A1-B2-C4-D3-E3-F2)

Suola 100% in para aramidico e chiusura sul retro tramite Velcro® F.R. Taglia unica.

TAA55 - calzari coibentati per completi TAA51 e TAA57

10 GUANTI ANTICALORE III^A CATEGORIA

Guanti tipo 2 III^a categoria, palmo in tessuto diagonale 100% para aramidico con dorso e manico in tessuto alluminizzato coibentato. Lunghezza mm 350. **A norma: EN420 - EN388 - EN407.**

GA5035 - guanti anticalore, taglia unica

! LA CERTIFICAZIONE DEL COMPLETO SI RIFERISCE AI CODICI: TAA57 + TAA54 + TAA55 + GA5035 UTILIZZATI CONTEMPORANEAMENTE.



1 COMPLETO IGNIFUGO ANTISTATICO, RESISTENTE ALL'ARCO ELETTRICO III CATEGORIA



Tessuto 98% cotone ignifugato 2% fibre di carbonio **peso 260 gr/m²**. Giacca con collo a camicia bottoni automatici coperti, elastico ai polsi, due tasche al petto chiuse con pattina e velcro. Rinforzo sulle spalle e doppie cuciture. Pantaloni chiusi con patta con bottoni coperti, due tasche anteriori e una posteriore. A norma: UNI EN ISO 13688:2013; UNI EN ISO 11611:2015; UNI EN ISO 11612:2015; UNI EN 1149-5:2008/ CEI EN 61482-1-2:2008 classe 1; CEI EN 61482-1-1 ATPV 8,9 cal/cm².

- 1 **TACP550.** - giacca per arco elettrico colore blu, taglie fornibili dalla S alla XXL
- 2 **TACP551.** - pantalone per arco elettrico colore blu, taglie fornibili dalla S alla XXL

COMPLETO IGNIFUGO ARCO ELETTRICO, ANTISTATICO, ANTIACIDO, III CATEGORIA



Tessuto 78% cotone ignifugato, 20% poliestere, 2% fibra dissipativa **peso 250 gr/m²**. Giacca con collo a camicia bottoni automatici coperti, elastico ai polsi, due tasche al petto chiuse con pattina e velcro, rinforzo sulle spalle. Pantaloni chiusi con patta con bottoni coperti, due tasche anteriori e una posteriore. A norma: UNI EN ISO 13688:2013; UNI EN ISO 11611:2015; UNI EN ISO 11612:2015; UNI EN 1149-5:2008 / UNI EN 13034:2005; CEI EN 61482-1-2 classe 1.

- 3 **TACP553.** - giacca, taglie fornibili dalla S alla XXL
- 4 **TACP554.** - pantalone, taglie fornibili dalla S alla XXL

7 GUANTI IN COMPOSITO RESISTENTI AD ARCO ELETTRICO III CATEGORIA



Guanti isolanti 3 in 1: protezione dielettrica, meccanica e anti-arco. Materiale composito bicolore che facilita l'ispezione visiva. Protezione meccanica integrata: non è necessario il sopra guanto in pelle. Resistenza all'arco elettrico attestata presso laboratorio qualificato. Colore esterno rosso, colore interno nero e categoria RC. L'esclusiva formula della miscela di gomma rende i guanti estremamente flessibili. Ogni paio di guanti viene fornito con un paio di sottoguanti in cotone per assorbire il sudore. Lunghezza 410 mm. A norma IEC61482-1-2 CLASS 2 (0.5s - 7kA), EN60903:2003, IEC60903:2014, ASTM F2675. Taglie (EN): 8-9-10-11.

- GDRD500/.** - guanti classe 00, spessore max < 2,4 mm, voltaggio di prova 2.500 (V)/AC, voltaggio d'uso 5.00 (V)/AC, ATPV ASTM F2675 26,3 cal/cm²
- GDRD1000/.** - guanti classe 0, spessore max < 2,9 mm, voltaggio di prova 5.000 (V)/AC, voltaggio d'uso 1.000 (V)/AC, ATPV ASTM F2675 71,6 cal/cm²
- GDRD7500/.** - guanti classe 1, spessore max < 3,4 mm, voltaggio di prova 10.000 (V)/AC, voltaggio d'uso 7.500 (V)/AC, ATPV ASTM F2675 42,2 cal/cm²
- GDRD17000/.** - guanti classe 2, spessore max < 3,9 mm, voltaggio di prova 20.000 (V)/AC, voltaggio d'uso 17.000 (V)/AC, ATPV ASTM F2675 74,5 cal/cm²
- GDRD26500/.** - guanti classe 3, spessore max < 4,2 mm, voltaggio di prova 30.000 (V)/AC, voltaggio d'uso 26.500 (V)/AC, ATPV ASTM F2675 73,2 cal/cm²
- GDRD36000/.** - guanti classe 4, spessore max < 4,8 mm, voltaggio di prova 40.000 (V)/AC, voltaggio d'uso 36.000 (V)/AC, ATPV ASTM F2675 87,7 cal/cm²

5 CAMICE ANTISTATICO II CATEGORIA



Camice antistatico colore bianco con sottili righe grigie, tessuto: 99% cotone, 1% fibra antistatica, peso 160 g/m². Collo a giacca, chiusura con bottoni coperti, due tasche anteriori e una superiore. Polsini con elastico. Taglie: S (42-44), M (46-48), L (50-52), XL (54-56), XXL (58-60). A norma EN ISO 13688 e EN1149-5.

TACP1543. - camice antistatico

6 CAMICIA TRIVALENTE III CATEGORIA



Tessuto Ripstop 98% cotone 2% fibra carbonio antistatica, **peso 130 gr/m²**. Maniche a giro polsi chiusi con bottoni, chiusura centrale con bottoni ricoperti, tasche applicate al petto. A norma: UNI EN ISO 14116:2015; UNI EN 1149-5:2008; UNI EN 13034:2005 type 6.

TACP528. - camicia trivalente (ignifuga, antistatica e antiacido, taglie fornibili dalla S alla XXL



COMPLETO IGNIFUGO AD ALTA VISIBILITÀ



Offre una protezione ideale contro l'esposizione ai rischi industriali, proteggendo da calore da contatto, convettivo e radiante. Tessuto esterno: 60% modacrilico, 39% cotone, 1% fibra di carbonio 280 g.

- 1 **PWT25.** - giacca ad alta visibilità, 4 ampie tasche, chiusura con zip e bottoni nascosti, polsini regolabili, anello porta radio taglie fornibili dalla S alla XXL
- 2 **PWT26.** - pantalone ad alta visibilità, vita elasticizzata, tasca porta metro, due tasche posteriori, tasche per ginocchiere a due livelli. Taglie fornibili dalla S alla XXL



3 GIACONE IGNIFUGO PER SQUADRE ANTINCENDIO



Giaccone in Nomex® che protegge da calore da contatto, convettivo e radiante. Impermeabile e traspirante, con cuciture nastrate per prevenire la penetrazione dell'acqua. Zip di chiusura frontale a rilascio rapido, tasche laterali con bottone di chiusura e polsini in maglia, tasca frontale inferiore con chiusura a strappo, tasca per radio adatta a tutte le dimensioni, proteggi gola su colletto, polsini regolabili a strappo. **Marcato UKCA, III^a categoria.**

PWT30. - giaccone ignifugo per squadre antincendio, taglie fornibili dalla S alla XXL

4 SOVRA PANTALONI IN NOMEX®



Proteggono la parte bassa del corpo. Le bretelle non staccabili, la vita elasticizzata e la chiusura a rilascio rapido garantiscono un'ottima libertà di movimento. A norma EN 469 (livello 2).

PWT31. - sopra pantaloni in Nomex®, taglie fornibili dalla S alla XXL



COMPLETO PER CELLA FRIGO



Tessuto esterno: 100% Oxford in poliestere traspirante. Fodera in tessuto: 100% poliestere Taffeta 60 g. Tessuto di riempimento: 100% poliestere 300 g. Finitura anti macchia. Protezione contro il freddo fino a -58°C.

- 5 **PWT10.** - giacca 3/4 per cella frigo con cerniera robusta, polsini lunghi e stretti con foro per il pollice. Nastro riflettente, tasca sul petto con tasca porta badge. Taglie fornibili dalla S alla XXL
- 6 **PWT11.** - pantaloni traspiranti, antivento e impermeabili con salopette anteriore e posteriore, retro vita e bretelle elastiche. Nastro riflettente, rinforzi sulle ginocchia, tasche per ginocchiere, tasche laterali oversize. Taglie fornibili dalla S alla XXL



COMPLETO TERMICO



Offre isolamento, protezione termica e calore ottimale in ogni momento, grazie al tessuto traspirante che assorbe l'umidità dal corpo mantenendo la pelle asciutta. Tessuto esterno: 50% poliestere, 50% cotone 200 g.

- 7 **PWT123.** - maglia termica a maniche lunghe, vestibilità comoda, girocollo ideale per essere indossata come sotto-capo. Taglie fornibili dalla S alla XXL
- 8 **PWT121.** - calzamaglia termica e isolante con orlo a costine ed elastico in vita per una vestibilità comoda. Taglie fornibili dalla S alla XXL



COMPLETO IGNIFUGO ANTISTATICO



Resistente, ideale per i lavoratori esposti al calore. Antistatico, protegge da calore da contatto, convettivo e radiante. Tessuto classificato 40+UPF per bloccare il 98% dei raggi UV. CE - CAT III. Marcato UKCA.

- 9 **PWT12.** - felpa maniche raglan lunghe, girocollo e polsini a costine. Tessuto esterno: 60% modacrilico, 39% cotone, 1% fibra di carbonio x 2 strati 300 g. Taglie fornibili dalla S alla XXL
- 10 **PWT14.** - sottopantaloni colore blu ignifughi e antistatici. Tessuto esterno: 60% modacrilico, 39% cotone, 1% fibra di carbonio 200 g. Vita elasticizzata per una vestibilità comoda. Taglie fornibili dalla S alla XXL



COMPLETO AD ALTA VISIBILITÀ



Protezione ottimale in ambienti multi pericolosi. Tessuto con resistenza intrinseca alle fiamme, schizzi di sostanze chimiche, arco elettrico e pericoli di saldatura. Protegge da calore da contatto, convettivo e radiante. Tessuto esterno: Modafleme HVO woven: 61% modacrilico, 18% viscosa, 15% poliestere, 5% aramide, 1% fibra di carbonio 300 g. CE - CAT III. Marcato UKCA.

- 1 **PWT35.** - giacca ad alta visibilità, tasche laterali con zip, 4 ampie tasche (tasca nascosta per il cellulare), polsini regolabili. Taglie fornibili dalla S alla XXL
- 2 **PWT36.** - pantalone ad alta visibilità con 9 ampie tasche, tasche per ginocchiere, retro vita elastico, orlo regolabile e inserti a contrasto. Taglie fornibili dalla S alla XXL



3 BOMBER AD ALTA VISIBILITÀ



Maniche staccabili con cerniera, cappuccio a scomparsa, fodera trapuntata, cuciture impermeabili nastrate, polsini e girovita elasticizzati per vestibilità aderente e massimo comfort. Tessuto esterno: 100% poliestere, trama Oxford 300D anti macchia, rivestito PU 100% poliestere, doppio rivestimento in PU 190 g. Fodera in tessuto: 100% poliestere 60 g. Tessuto di riempimento: 100% poliestere 170 g.

PWT486. - bomber ad alta visibilità, taglie fornibili dalla S alla XXL



4 GILET AD ALTA VISIBILITÀ



Leggero e confortevole, bande riflettenti per una maggiore visibilità. Chiusura a strappo per un facile accesso, vestibilità abbondante per un maggior comfort. Certificato EN ISO 20471 per oltre 50 lavaggi, conforme RIS 3279-TOM per l'industria ferroviaria. Taglie fornibili dalla S alla XXL.

PWT474. - gilet colore arancio
PWT000. - gilet colore giallo



5 GIACCA AD ALTA VISIBILITÀ



Giacca impermeabile e traspirante con ampie tasche, cappuccio a scomparsa, collo foderato e cuciture nastrate per prevenire la penetrazione dell'acqua. Polsini regolabili a strappo, collo foderato in pile per un maggior calore, giacca interna reversibile staccabile, tasche scaldamani. Taglie fornibili dalla S alla XXL.

PWT426. - giacca ad alta visibilità colore arancio
PWT427. - giacca ad alta visibilità colore giallo



6 FELPA AD ALTA VISIBILITÀ



Realizzato per durare a lungo, questo indumento è adatto a tutti i tipi di ambienti lavorativi. Gli inserti a contrasto sul gomito in 600D 100% poliestere forniscono maggiore supporto e durata nel tempo. Tessuto esterno: 65% poliestere, 35% cotone 300g. Tessuto a contrasto: 100% poliestere Oxford 600D.

PWT308. - felpa ad alta visibilità, taglie fornibili dalla S alla XXL



7 GILET AD ALTA VISIBILITÀ



Pratico, leggero, ideale in tutte le situazioni in cui una giacca può essere troppo calda. 7 ampie tasche (con tasca porta badge e tasca porta penne/cellulare), D-ring per chiavi o ID card. Certificato EN ISO 20471 per oltre 50 lavaggi. Conforme RIS 3279-TOM per l'industria ferroviaria. Marcato UKCAPWT12S. Taglie fornibili dalla S alla XXL.

PWT476. - gilet colore arancio
PWT000. - gilet colore giallo



1 PARKA IDROREPELENTE MULTIRISCHIO II CATEGORIA



Parka bicolore giallo/blu, tessuto esterno 98% poliestere, 2% fibra antistatica spalmato poliuretano, con ignifugazione e bande rifrangenti ignifughe. Multiprotezione, ignifugo, antistatico, antiacido. Chiusura centrale con cerniera e bottoni a pressione, 2 tasche inferiori e 1 tasca al petto chiuse con bottoni a pressione. Cappuccio staccabile con coulisse, fondo manica con velcro per regolazione chiusura polso. Conforme alle norme: EN ISO 13688; EN 14116; EN ISO 20471; EN ISO 13034 Type PB6; EN 1149-5; EN 343 1:1.

TACP613. - parka multiprotezione ad alta visibilità, taglie fornibili dalla M alla XXL

2 PARKA ANTIFREDDO MULTIRISCHIO III CATEGORIA



Parka bicolore giallo/blu, tessuto esterno 98% poliestere, 2% fibra dissipativa + PU. Multiprotezione, ignifugo, antistatico, arco elettrico, antiacido. Chiusura centrale con cerniera e bottoni a pressione, 2 tasche inferiori e 1 tasca al petto chiuse con bottoni a pressione. Cappuccio staccabile con coulisse, fondo manica con velcro per regolazione chiusura polso. Conforme alle norme: EN ISO 13688; EN ISO 11611 classe 1; EN ISO 11612 A1 B1 C1; EN ISO 20471; EN ISO 13034 Type PB6; EN 1149-5; EN 343 3:1; EN 14058; EN 61482-1-2/15 classe 1. Abbinato al sottogiacca isotermico ignifugo TACP612 (EN 14058).

TACP614. - parka multiprotezione ad alta visibilità, taglie fornibili dalla M alla XXL

TACP612. - sottogiacca colore blu isotermico, ignifugo, taglie fornibili dalla M alla XXL



3 GIACCA INGON



Pratica giacca ad alta visibilità con 2 passanti, 4 tasche esterne e 1 interna. Materiale: tessuto ignifugo 57% aramidico - 42% poliestere - 1% AST, peso 260 g/m². Eccellente protezione contro arco elettrico o altri pericoli di calore e fiamme industriali. A norma EN ISO 20471 classe 3. Taglie fornibili dalla 44 alla 64.

TAX166.. - giacca ignifuga Ingon

4 GIACCONE ECOFIRE



Giaccone Ecofire in fibra metaaramidica di circa 165 gr, completo di gilet interno staccabile, collo alto con alamaro di chiusura a velcro, maniche con fondo di regolazione tramite velcro, due tasche. Colore arancio con bande retroriflettenti. Certificato EN531 - II Categoria. Taglie fornibili: L - XL - XXL.

TAX165.. - giaccone Ecofire in fibra metaaramidica



1

2



COMPLETO AD ALTA VISIBILITÀ MULTIRISCHIO III CATEGORIA

Tessuto 78% cotone ignifugato, 20% poliestere, 2% fibra dissipativa, peso 250 gr/mq. Multiprotezione, ignifugo, antistatico, arco elettrico, antiacido. Giacca: collo a camicia, maniche a giro con elastico ai polsi, chiusura anteriore con bottoni automatici, 2 tasche al petto chiuse con pattine e velcro, rinforzo sulle spalle, 2 bande retroriflettenti che circondano il torace e 2 bande sulle maniche. Pantalone: chiusura a patta con bottoni coperti, 2 tasche anteriori a filetto, 1 tasca posteriore applicata chiusa con pattina e velcro, 1 tasca laterale chiusa con pattina e velcro, rinforzo interno al cavallo, doppie cuciture nei punti di maggior sforzo, 2 bande retroriflettenti che circondano le gambe. Conforme alle seguenti norme: EN ISO 13688; EN ISO 11611; EN ISO 11612 A1 B1 C1; EN ISO 20471; EN 13034 Type 6; EN 1149-5; EN 61482-1-2 CL1.

1 TACP537. - giacca bicolore giallo/blu multirischio ad alta visibilità, taglie fornibili dalla M alla XXL

2 TACP538. - pantalone bicolore giallo/blu multirischio ad alta visibilità, taglie fornibili dalla M alla XXL



3



A

PARTE INTERNA



4



PARKA TRIPLO USO WINTER AD ALTA VISIBILITÀ II CATEGORIA



Parka triplo uso impermeabile e traspirante, bande rifrangenti 3M™. Parka esterno con 2 tasche inferiori chiuse con pattina e bottoni a pressione, 1 tasca al petto con pattina chiusa con bottoni a pressione, velcro per porta badge, chiusura polsi regolabile con bottone a pressione. Gilet interno (A) autoportante con maniche staccabili imbottite in trapunta, 2 tasche inferiori con pattina chiusa con velcro, 1 tasca porta penne al petto, polso elastico antivento. Taglie dalla S alla XXXL. A norma EN ISO 13688 - EN ISO 20471 - EN 343 - Classe 3-3 impermeabile e traspirante.

3 VPAP413. - parka bicolore blu/arancio

4 VPAP414. - parka colore arancio



REVERSIBILE!

5



5 GIUBBOTTO REVERSIBILE AD ALTA VISIBILITÀ



Giubbotto in poliestere e cotone, chiusura con cerniera, maniche staccabili, polsini e fondo in maglia, 4 tasche esterne e 4 interne con cerniera, taschino con cerniera sulla manica, bande retroriflettenti. Duplice funzione: lato arancione ad alta visibilità per attività lavorative, lato blu non riflettente per attività extra lavorative. Conforme alla norma EN ISO 20471.

VPA715. - giubbotto Pilot ad alta visibilità reversibile, colore arancio fluo e blu, taglie fornibili dalla M alla XXL



REVERSIBILE!

6



6 GILET REVERSIBILE AD ALTA VISIBILITÀ



Pratico gilet reversibile 100% poliestere, doppio uso alta visibilità da un lato e tinta unita blu dall'altro. 4 tasche applicate nel lato blu e 1 tasca porta cellulare nel lato ad alta visibilità. Conforme alla norma EN ISO 20471.

VPA720. - gilet in poliestere ad alta visibilità reversibile, colore arancio fluo e blu, taglie fornibili dalla M alla XXL



INDUMENTI AD ALTA VISIBILITÀ, GILET ATEX



1



3 (giubbotta)



2 (pantaloni)



2



3 (giubbotta)



2 (pantaloni)



3



2

3 POLO AD ALTA VISIBILITÀ II CATEGORIA



Tessuto piquet 100% poliestere 200 gr/mq colore arancio, con bande 3M™ Scotchlite 8910. Collo chiuso con 2 bottoni. Collo e giromanica colore grigio. Taglie: dalla S alla XXXL. A norma UNI EN ISO 20471.

VPAP1130A. - polo ad alta visibilità colore arancio



4



3

4 PILE BICOLORE AD ALTA VISIBILITÀ



Pile in poliestere ad alta visibilità, collo a fascetta con zip, elastici al fondo maniche e vita. Taschino con cerniera, 2 tasche. Lavorazione anti-pilling. Bande retroriflettenti 3M™ Scotchlite®. Taglie: dalla M alla XXL.

VPA453. - pullover bicolore arancio/blu

1 COMPLETO ESTIVO AD ALTA VISIBILITÀ II CATEGORIA



Tessuto fluorescente: poliestere 35%, cotone 65%, peso 210 gr/mq; Scotchlite 8910. Giubbotta con collo a camicia chiusura anteriore con bottoni coperti, 2 tasche al petto e polsini fondo manica chiusi con bottoni; pantalone con patta e bottoni ricoperti, 2 tasche anteriori, 1 posteriore più tasca portametrometro. Taglie: dalla S alla XXXL. A norma UNI EN ISO 20471.

VPAP530A/. - giubbotta estivo colore arancio

VPAP530Y/. - giubbotta estivo colore giallo

VPAP531A/. - pantalone estivo colore arancio

VPAP531Y/. - pantalone estivo colore giallo

2 COMPLETO INVERNALE AD ALTA VISIBILITÀ II CATEGORIA



Tessuto fustagno fluorescente: poliestere 40%, cotone 60%, peso 350 gr/mq; Scotchlite 8910. Giubbotta con collo a camicia chiusura anteriore con bottoni coperti, 2 tasche al petto e polsini fondo manica chiusi con bottoni; pantalone con patta e bottoni ricoperti, 2 tasche anteriori, 1 posteriore più tasca portamento. Taglie: dalla S alla XXXL. A norma UNI EN ISO 20471.

VPAP535A/. - giubbotta invernale colore arancio

VPAP536A/. - pantalone invernale colore arancio



5



POSSIBILITÀ DI PERSONALIZZAZIONE (A RICHIESTA).

EMERGENZA

5 GILET AD ALTA VISIBILITÀ



In poliestere, chiusura con velcro, taglia unica regolabile. Bande rifrangenti applicate. Rende visibile a distanza il personale impegnato su strada. D.M.L.P.P. del 9/6/95. Dispositivo di Protezione Individuale EN ISO 20471.

GBR07A - gilet colore arancio

GBR07Y - gilet colore giallo



22



6



6 GILET ATEX AD ALTA VISIBILITÀ



Gilet unico pezzo cucito alle spalle, completamente orlato con lo stesso tessuto di base, orlo da 7 mm, bande applicate cucite sul torace. Metal-free. Composizione: 98% poliestere, 2% fibre dissipate (carbonio), peso 120 g/m². Taglie: L (M/L) e XL (XL/XXXL).

GBR05Y. - gilet ATEX ad alta visibilità colore giallo fluo



EN 416



EN 149-5



EN 20471



Articoli vari ad alta visibilità



BRACCIALI RETRORIFLETTENTI

- 1 BR14A** - bracciale in PVC rosso fluo cm 50 x 10, chiusura con velcro con banda rifrangente cucita al centro altezza cm 3
- 2 BR14Y** - bracciale giallo fluo in poliuretano 69% - polietilene 20% - cotone 11%, cm 50 x 10, chiusura con velcro con banda rifrangente cucita al centro altezza cm 3



3 BRACCIALI RETRORIFLETTENTI

Bracciale in pellicola ad alta intensità a microprismi Reflexite®. Superficie liscia, chiusura regolabile in velcro, supporto in velluto. Raccomandati in condizioni di scarsa visibilità. **Per uso non professionale.**
BR07A - bracciale rosso fluo, cm 46 x 7



4 CINTURA

In pellicola rifrangente ad alta intensità luminosa Reflexite®, accoppiata in HF a supporto in velluto. Chiusura con fibbia in nylon regolabile.
BRC50Y - cintura giallo fluo, cm 125 x 4 h



5 MANICOTTI

Coppia di manicotti rifrangenti, per operatori del traffico in tessuto UNITIKA # MR 801.
BRM25 - coppia di manicotti colore grigio argento cm 45 x 25

Indumenti anti pioggia



COMPLETO ANTIPIOGGIA

Completo in nylon spalmato in PVC nastrato sulle cuciture. Giacca con cappuccio fisso all'interno del collo, aerazione su dorso e sotto le ascelle, chiusura con cerniera, due tasche con pattina. Pantalone con elastico in vita, bottone al fondo. Taglie fornibili: dalla M alla XXL.

- 6 VPP1710** - completo giacca/pantalone colore giallo
- 7 VPP1720** - completo giacca/pantalone colore verde

8 CAPPOTTO ANTIPIOGGIA

Cappotto in PVC/poliestere/PVC bispalmato. Cappuccio fisso, aerazione sul dorso e sotto le ascelle, due tasche con pattina. Taglie fornibili: dalla M alla XXL.

VPP510 - cappotto colore giallo

STIVALI VERDI IN PVC

Fodera in jersey, suola a carrarmato.

- 9 ZC6310** - stivale al ginocchio a norma EN347. Misure: 36/46
- ZC6425** - stivale al ginocchio a norma EN20345. Misure 38/47
- 10 ZC6301** - stivale tronchetto per rischi minimi. Misure: 38/47

Camici da lavoro



CAMICI DA LAVORO

Tre tasche applicate, martingala cucita, elastico ai polsi, chiusura con bottoni.

- 11 VPC8100** - camice colore blu, 100% cotone sanforizzato. Taglie fornibili: dalla 44 alla 58
- 12 VPC8111** - camice colore bianco da uomo in terital/cotone. Taglie fornibili: dalla M alla XXL
- 13 VPC8151** - camice colore bianco da donna in terital/cotone. Taglie fornibili: dalla S alla XL

Tuta ignifuga repellente per insetti



14 TUTA IGNIFUGA REPELLENTE PER INSETTI

Super leggera, garantisce protezione da numerosi insetti. Il repellente per insetti è intrinseco alla fibra ed inodore. Tessuto: 99% cotone, 1% fibra di carbonio. Protegge da calore da contatto, convettivo e radiante. A norma EN ISO 11612 (A1+A2, B1, C1, E2, F1), EN ISO 11611 Classe 1 (A1+A2), EN 1149-5. Peso: 210 g. Taglie fornibili: dalla S alla XXL.
PWT22 - tuta ignifuga repellente per insetti colore blu navy



GILET ESTIVO SAFE IN®

Gilet multitasche con inserti ad alto potere riflettente. Realizzati con tessuto (98% cotone, 2% elasthan, 245 g/m²), aventi caratteristiche di qualità e resistenza superiori. Inserti in tessuto tecnico antiusura, coulisse per aumentare l'aderenza e il comfort. A norma EN ISO 13688:2013. Taglie fornibili dalla S alla XXXL.

- 1 **VPSS692B.** - gilet multitasche colore beige
- 2 **VPSS692S.** - gilet multitasche colore grigio

3 GILET IMBOTTITO SAFE IN®

Gilet imbottito con parte posteriore sagomata. Tessuto esterno nylon 100% poliestere da 175 g/m². Fodera interna ad alta intensità. Interno collo in pile. Coda di topo in materiale rifrangente di colore grigio, su petto e su schiena. Taschino al petto destro con porta penna esterno, chiuso da pattina sagomata. Sulla parte inferiore del taschino è presente un supporto per l'aggancio di porta badge. Due tasche inferiori a soffietto chiuse da pattina sagomata. A norma EN ISO 13688:2013. Colore blu. Misure: dalla S alla XXXL.

VPSS625B. - gilet imbottito colore blu



PANTALONE SAFE IN®

Pantaloni da lavoro realizzati con tessuto (98% cotone 2% elasthan, 245 g/m²) aventi caratteristiche di qualità e resistenza superiori. Fascia per la protezione lombare, inserti elastici per aumentare il comfort e agevolare i movimenti e di tessuto tecnico per aumentare la resistenza nei punti di maggior attrito. Sistema di regolazione della lunghezza millimetrica **[A]**. A norma EN ISO 13688:2013. Taglie fornibili dalla S alla XXXL.

- 4 **VPSS104B.** - pantalone colore beige
- 5 **VPSS104S.** - pantalone colore grigio



6 GIUBBINO SAFE IN®

Giubbino imbottito con cappuccio fisso con tiretti di regolazione. Tessuto esterno nylon 100% poliestere, foderato internamente in pile su corpo e cappuccio. Fondo manica con alamaro di regolazione con velcro ed elastico nella parte inferiore del polso. Una tasca interna su lato destro, un'altra tasca napoleone su lato sinistro entrambe chiuse da cerniera. A norma EN ISO 13688:2013. Colore blu. Misure: dalla S alla XXXL.

VPSS867B. - giubbino imbottito colore blu



7 FELPA SAFE IN®

Felpa aperta frontalmente con zip, realizzata con tessuto (80% cotone, 20% poliestere, 340 g/m²). Inserto in tessuto misto cotone 60% poliestere 40% cotone con colore a contrasto su parte posteriore dell'avambraccio e su spalle. Due tasche inferiori chiuse da zip. Colore blu con contrasti di colore grigio **[B]**. A norma EN ISO 13688:2013. Colore blu. Misure: dalla S alla XXXL.

VPSS044B. - felpa colore blu



1

1 TUTA IN COTONE



2 tasche più 2 taschini. Tasca posteriore e tasca porta metro. Elastico in vita nella parte posteriore e rimovibile ai polsi. Chiusura con cerniera in nylon ricoperta da patta. Collo a camicia.

VPS8070/. - tuta colore blu, taglie fornibili dalla 44 alla 60



2

2 FELPA



Felpa mezza zip con costina elasticizzata su polsini e fondo. Tessuto stabilizzato per evitare il restringimento. Composizione 65% cotone 35% poliestere. Taglie: dalla S alla XXL.

VPS4820. - felpa colore blu



3

3 GIACCONE PARKA MASTERPLUS



Giaccone antifreddo **triplo uso** impermeabile. Esterno sintetico con cuciture nastrate, quattro tasche a soffietto, scaldamani, cappuccio, porta tessera, porta telefono, porta occhiali, aerazione dorsale. Interno trapuntato (A) antifreddo con imbottitura in poliestere foderato con flanella di cotone scozzese, staccabile e utilizzabile singolarmente, due tasche esterne, una interna, maniche staccabili. Taglie: dalla S alla XXL.

VPS4661. - giaccone antifreddo Parka Masterplus, triplo uso, colore blu



4



MAGLIETTE STRETCH A MANICA CORTA



Maglietta stretch manica corta, girocollo, bicolore, Composizione 96% cotone 5% elastane da 180 g/m². Taglie fornibili: dalla S alla XXL.

4 VPS8772G. - maglietta manica corta colore grigio con inserti neri

5 VPS8772M. - maglietta manica corta colore beige con inserti neri

6 VPS8772B. - maglietta manica corta colore blu con inserti grigi



7



8

POLO A MANICA CORTA



Polo in cotone 100% pettinato da 190 g/m². Manica corta con girocollo tergisudore. Taglie fornibili: da S a XXL.

7 VPS8185. - polo colore blu

8 VPS8186. - polo colore bianco

CAMICIE



Camicie 100% cotone. Taglie dalla S alla XXL.

9 VPS8161. - camicia manica corta

10 VPS8160. - camicia manica lunga



9



10



11



12

11 PANTALONE IN COTONE



Pantalone in cotone con tasche anteriori, tasca posteriore con bottone e tasca porta metro, passanti in vita ed elastico sulla parte posteriore, patta con bottoni.

VPS8030/. - pantalone, taglie fornibili dalla 40 alla 60

12 BERMUDA IN COTONE



Bermuda in cotone leggero 100% gr 220/m², per ambienti caldi. Due tasche ai fianchi, tasca posteriore e due tasconi laterali chiusi con velcro. Passanti in vita con elastico nella parte posteriore. Taglie fornibili dalla S alla XL.

VPS8034. - bermuda in cotone colore blu



1

NEW



2



3

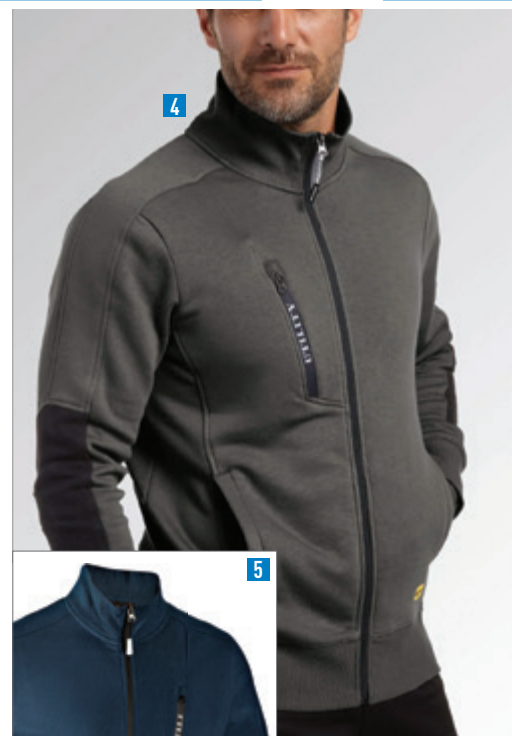

4



5

1 GIACCA DA LAVORO SOFTSHELL CARBON TECH



Giacca con tecnologia Breathing System by Geox. Cappuccio staccabile, 2 tasche laterali e 1 frontale con zip, tasca interna con velcro. Manica ergonomica con polsini regolabili. Composizione: 94% poliestere, 6% elastane, 310 gr/m² + membrana in PU. Taglie disponibili dalla S alla XXXL.

VP5D640N. - giacca SoftShell Carbon Tech colore nero

PILE SWEAT



Pile Sweat da lavoro con doppia gazatura 100% poliestere, 280 g/m². Tasche mani e taschino al petto con zip personalizzata. Taglie fornibili: dalla S alla XXXL.

2 VP5D118B. - pile colore blu

3 VP5D118G. - pile colore grigio

FELPA DA LAVORO



Felpa full zip garzata, maniche lunghe e inserti laterali su maniche e fianchi. 2 tasche aperte laterali e 1 tasca frontale con zip. Collo, polsini e fondo in costina elasticizzata. Composizione 80% cotone, 20% poliestere, 280 gr/m². Taglie fornibili: dalla S alla XXXL.

4 VP5D943S. - felpa colore grigio acciaio

5 VP5D943B. - felpa colore blu classico



6



7



8



9



10

6 BOMBER DA LAVORO D-SWAT



Bomber imbottito con maniche staccabili in tessuto idrorepellente, cappuccio di servizio, tasca interna, tasca cartuccera sulla manica sinistra, porta badge, dettagli reflex e confortevole costina su polsi e vita. Taglie fornibili: dalla XS alla XXXL.

6 VP5D175N. - bomber D-Swat colore nero

7 VP5D175B. - bomber D-Swat colore blu

8 PANTALONE DA LAVORO CARGO



Pantalone cargo, due tasche laterali e due tasche dietro, dettagli rifrangenti, elastico in vita, tripla cucitura. Pence sulle ginocchia per una maggiore ergonomia. Peso 260 g. Taglie fornibili: dalla S alla XXL.

8 VP5D75070G. - pantalone cargo colore grigio

9 VP5D60062B. - pantalone cargo colore navy

10 JEANS STONE



Cotone 98% Denim - 2% Elastane con 4 tasche + tasca porta metro e passante porta martello. Perfetta vestibilità. Taglie: dalla M alla XXL.

VP5D590. - stretch denim jeans stone washed

1

1 GIACCONE PARKA DIAMOND

Giaccone impermeabile termosaldato foderato in morbido pile. Colore blu, tasche e tasconi chiusi con zip, 2 tasche interne portadocumenti e taschino porta cellulare, chiusura con zip e pattina con bottoni a pressione, polsino a fondo manica regolabile con velcro, cappuccio staccabile, vita regolabile con coulisse interna. Tessuto 100% poliestere spalmato. Taglie fornibili: dalla S alla 3XL. A norma UNI EN 14058, UNI EN 343 Classe 3:3.

VPG209. - giaccone colore blu

2

2 GIACCONE PARKA SCOUT

Giaccone Parka Scout con 2 tasche interne portacellulare e portadocumenti, inserti rifrangenti, polsini antifreddo. Tessuto Rip Stop ed elastico con zip waterproof, cappuccio staccabile, taschino sulla manica. Tessuto: 100% poliestere + 100% nylon PU. Taglie fornibili: dalla S alla 3XL. A norma UNI EN 14058.

VPG219. - giaccone colore nero

6

3

GRAZIE ALLE ZIP, OGNI MISURA PUÒ VESTIRE 3 TAGLIE!

3 PANTALONE MULTITAGLIA TRINITY

Pantalone brevettato in 3 misure, studiato affinché ciascuna misura possa vestire tre taglie, grazie all'inserimento, in punti strategici (fianchi tasche anteriori e nella zona lombare) di aperture con zip che a seconda del grado di chiusura si adattano a chi indossa il pantalone. Tessuto: 97% cotone 3% elasthan 240 gr/m². Fornibile nelle taglie M (42/44/46), L (48/50/52), XL (54/56/58).

VPG146. - pantalone multitaglia colore blu

4
4 PANTALONE JEANS BIKER

Inseri con cuciture elasticizzate sul retro e sulle ginocchia per maggior comfort nel movimento, tasconi laterali e sul retro chiusi con bottoni a pressione, tasca portametro. Tessuto: 70% cotone 28% poliestere 2% elasthan, 10,5 once. Fornibile nelle taglie: dalla XS alla 3XL.

VPG145. - jeans colore blu

5
5 PANTALONE HAMMER

Pantalone Hammer da lavoro con tasconi applicati e rinforzo sulle ginocchia con porta ginocchiere (non fornite). Tessuto 60% cotone 40% poliestere 240 gr/m². Fornibile nelle taglie dalla S alla 3XL.

VPG820. - pantalone colore grigio/nero

6 LINEA EXPLORER

Giubbino con fianchi in tessuto stretch per agevolare i movimenti, interno collo in tessuto felpato, tasca portabadge staccabile. Pantaloni con fianchi e ginocchia in tessuto stretch e dettagli fluo a contrasto. Dettagli colore arancio. Tessuto canvas: 65% poliestere 35% cotone 265 gr/m². Fornibili nelle taglie: dalla S alla 3XL.

VPG419. - giubbino colore grigio
VPG420. - pantalone colore grigio



ABBIGLIAMENTO INTIMO TECNICO

Abbigliamento intimo traspirante antifreddo

Indumenti realizzati con fibra in Polipropilene che non trattiene umidità, permettendo l'isolamento termico e mantenendo il corpo a una temperatura ottimale. Grazie alle proprietà batteriostatiche, gli indumenti risultano antiallergici e antifodora. L'elastomero rende elastici ed ergonomici i capi realizzati con materiali B-Fit, garantendo massima libertà di movimento.



IDEALI PER CHI OPERA IN AMBIENTI A BASSA TEMPERATURA ED ESTERNI DURANTE LA STAGIONE INVERNALE.

ABBIGLIAMENTO INTIMO ANTIFREDDO

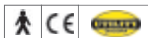

Composizione: 50% poliammide - 45% polipropilene - 5% elastane da 190 gr/mq. Pantalone e maglia anallergici e inodore, mantengono la pelle asciutta e la temperatura del corpo costante favorendo l'isolamento termico. Taglie fornibili: XS - M (S/M) - L (L/XL) - XXL.

- 1 **VPSD596.** - pantalone unisex senza cuciture
- 2 **VPSD597.** - maglia unisex senza cuciture, maniche lunghe

Abbigliamento intimo traspirante antifreddo in doppio strato traforato

Indumenti realizzati con tessuto 100% polipropilenico da 130 gr/mq, termoregolante e antifreddo. Anti-stress, con fascia elastica contenitiva antiforsione per la massima vestibilità, stabilità e aderenza dell'indumento.



IL DOPPIO STRATO DI MAGLIA TRAFORATA GARANTISCE UNA ELEVATA TRASPIRABILITÀ E RIMOZIONE DELL'UMIDITÀ CORPOREA.

ABBIGLIAMENTO INTIMO ANTIFREDDO



Polsini elasticizzati, morbido colletto e coulisse elasticizzati con effetto stabilizzante e con proprietà anallergiche e antidoloranti. Cuciture piatte a 4 aghi. Taglie fornibili: M - L - XL - XXL - 3XL.

- 3 **VPSI30.** - sottotuta lungo senza patta unisex
- 4 **VPSI31.** - maglia manica lunga girocollo unisex
- 5 **VPSI32.** - t-shirt girocollo unisex

Calze tecniche

Realizzate con la combinazione dei migliori filati tecnologici di alta qualità. Le strutture tecniche ergonomiche e i rinforzi anatomici assicurano la massima performance con effetto tonificante anti-stress. Cuciture piatte extra-fine. Punta e tallone traspiranti e rinforzati per proteggere e rinfrescare il piede e aumentare la resistenza all'usura. Rinforzo protettivo anti-usura anatomico per il tendine d'Achille. Speciale struttura per evitare la formazione di grinze. Massima vestibilità, aderenza e comfort. Cuscini anatomici in spugna differenziati per piede DX e SX, svolgono una funzione ammortizzante/riposante per il tallone e il palmo del piede. Inserti a strisce parallele nella zona plantare, aumentano la traspirazione e il mantenimento costante del microclima. **Taglie fornibili: S (36/39) M (40/43) L (44/47).** **Confezione minima: 3 lotti da 6 paia totali colori assortiti (giallo, arancio, verde, blu, rosso, grigio).**

CALZE TECNICHE DA LAVORO RINFORZATE E CONFORTEVOLI. GARANTISCONO UN EQUILIBRIO TERMICO COSTANTE E LA TRASPIRAZIONE DELLA PELLE IN OGNI CONDIZIONE DI CALDO, FREDDO, UMIDITÀ. LE FASCE ELASTICHE ANTI-TORSIONE FAVORISCONO ADERENZA E STABILITÀ, MENTRE TALLONE E PUNTA PIÙ ROBUSTI AUMENTANO LA RESISTENZA ALL'USURA.



6 ECLIPSE

Calze estive, taglio basso, colori assortiti. Composizione 40% cotone 34% polipropilene 23% nylon 2% elastane 1% carbonio no-shock. Taglie: S - M - L.

VPSI20. - confezione da 6 paia



7 ESCALADE

Calze estive, taglio corto, colori assortiti. Composizione 40% cotone 34% polipropilene 23% nylon 2% elastane 1% carbonio no-shock. Taglie: S - M - L.

VPSI21. - confezione 6 paia



8 EVOKE

Calze autunnali mezzo taglio, colori assortiti. Composizione 25% lana merino 25% acrilico 29% polipropilene 18% nylon 2% elastane 1% carbonio no-shock. Taglie: S - M - L.

VPSI22. - confezione 6 paia



9 ESSENCE

Calze invernali altezza ginocchio colori assortiti. Composizione 25% lana merino, 25% acrilico, 29% polipropilene, 18% nylon, 2% elastane, 1% carbonio no-shock. Taglie: S - M - L.

VPSI23. - confezione 6 paia



Articoli riscaldanti



1



2



3

**1 SOTTOCASCO INVERNALE**

Con doppia fascia: in caucciù per elmetto, in tessuto per la testa. Ideale per chi opera in ambienti a bassa temperatura in stagione invernale. Scocca 100% poliestere, rivestimento in PU. Fodera 100% pile, cinturino sottogola a strappo.

EDS684 - sottocasco invernale colore nero

2 PASSAMONTAGNA PER CASCHI

Passamontagna termico anti vento e anti freddo da usare con il casco. Collo lungo per assicurare la massima copertura. Tessuto riflettente per una maggior visibilità. Taglia unica.

EDS6821 - passamontagna in poliestere

3 PARAORECCHIE PER CASCHI

Paraorecchie termico elasticizzato anti vento e anti freddo. Da indossare con il casco. Taglia unica.

EDS6810 - paraorecchie in poliestere, taglia unica



4



TORCIA
REMOVIBILE!

4 BERRETTO CON LUCE FRONTALE

Pratico e comodo berretto con torcia LED incorporata che illumina fino a 20 metri di distanza. La torcia LED si rimuove facilmente dal cappellino per consentire il lavaggio anche in lavatrice. Ricaricabile con presa USB. Luminosità regolabile (25%, 50%, 100%). Materiale: 100% acrilico.

EDS610 - berretto colore con torcia LED colore nero



5

5 SCALDAPIEDI PER SCARPE

Difendono i piedi dalle basse temperature. Con ingredienti naturali, per attivarli è sufficiente aprirli (durata fino a 6 ore). Minimo ordinabile: 1 confezione da 5 pezzi (ogni pezzo contiene dx e sx).

EDS6995 - coppia di scaldapiedi taglia unica



6

6 SCALDAMANI PER GUANTI

Difendono le mani dalle basse temperature. Con ingredienti naturali, per attivarli è sufficiente aprirli (durata fino a 12 ore). Minimo ordinabile: 1 confezione da 10 paia.

EDS6990 - coppia di scaldamani da inserire nei guanti, taglia unica

Articoli rinfrescanti

Riducono la sensazione di calore (durata: 4 ore), rendendo confortevoli le condizioni di lavoro anche in condizioni di elevate temperature. Si attivano in modo facile e rapido immergendoli in acqua fredda per circa 1 minuto. Lavabili in lavatrice, sciacquare prima di ogni utilizzo.



7

7 INSERTO RINFRESCANTE PER ELMETTI

Rinfresca la testa e protegge il collo dai raggi UV. Si applica al casco tramite le chiusure a strappo.

EDS671 - inserto rinfrescante per elmetti



8

8 ASCIUGAMANO RINFRESCANTE

Asciugamano rinfrescante, protegge dai raggi UV, rinfrescando collo, braccia e dorso. Dimensioni 33 x 75 cm, spessore 2 mm.

EDS660 - asciugamano rinfrescante



9

9 BANDANA RINFRESCANTE

La bandana rinfresca testa e collo e si indossa perfettamente sotto gli elmetti.

EDS670 - bandana rinfrescante



ABBIGLIAMENTO MONOUSO

NORME E SIGNIFICATI DELLA SIMBOLOGIA



La marcatura CE attesta la conformità dell'indumento ai requisiti essenziali di salute e sicurezza fissati dalla legislazione UE.

1 2 3 4

Quattro cifre identificano il numero di riconoscimento dell'organismo notificato che ha emesso l'omologazione del prodotto e rilasciato la certificazione CE.

L'abbigliamento monouso e gli accessori monouso per la protezione parziale del corpo, offrono protezione dagli agenti chimici: vapori, liquidi e particelle pericolose. Per aiutarti a scegliere l'abbigliamento protettivo corretto, l'Unione Europea ha definito 6 livelli di protezione o "Tipi":



INDUMENTO IDONEO ALLA PROTEZIONE DAGLI AGENTI CHIMICI - CATEGORIA III

TIPO	PITTOGRAMMA	DESCRIZIONE	NORMA
Tipo 1		Indumenti di protezione contro prodotti chimici solidi, liquidi e gassosi pericolosi, inclusi aerosol liquidi e solidi (a tenuta di gas)	EN 943-1 - EN 943-2
Tipo 2		Indumenti di protezione contro prodotti chimici solidi, liquidi e gassosi pericolosi, inclusi aerosol liquidi e solidi (non a tenuta di gas)	EN 943-1
Tipo 3		Indumenti di protezione contro agenti chimici liquidi (a tenuta di liquidi)	EN 14605
Tipo 4		Indumenti di protezione contro agenti chimici liquidi (a tenuta di spruzzi)	EN 14605
Tipo 5		Indumenti di protezione per l'utilizzo contro particelle solide (prestazioni della tenuta a particelle solide disperse)	EN 13982-1
Tipo 6		Indumenti di protezione contro agenti chimici liquidi (offrono una protezione limitata contro agenti chimici liquidi)	EN 13034
		Indumenti di protezione - proprietà elettrostatiche	EN 1149
		Indumenti di protezione contro particolati solidi aerotrasportati inclusa la contaminazione radioattiva	EN 1073
		Indumenti di protezione contro gli agenti infettivi	EN 14126



1 TYCHEM "F"



Tuta colore grigio in materiale ottenuto laminando il polietilene stratificato Tyvek® a una pellicola rivestita con un polimero, resistente alle particelle e alla penetrazione di liquidi. Le tute, cucite e nastrate a caldo, hanno cappuccio, polsi e caviglie con elastico e doppia patella autoadesiva copricerniera.

TYV2. - tuta Tychem "F", taglie: M - L - XL. **Tipo 3, 4, 5 e 6**

2 TYVEK® CLASSIC PLUS



Tuta colore bianco in tessuto leggero e resistentissimo ottenuto legando, sotto l'azione del calore e della pressione, milioni di sottilissime fibre di polietilene, a protezione completa contro la penetrazione di particelle asciutte nocive (amianto). Cucita e nastrata a caldo: cappuccio, vita, polsi e caviglie con elastico, patella coprigola e una doppia patella autoadesiva che protegge la cerniera in Tyvek®.

TYV4. - tuta Tyvek® Classic Plus, taglie: M - L - XL - XXL. **Tipo 4, 5 e 6**

3 TYCHEM "C"



Tuta colore giallo in materiale ottenuto laminando il polietilene stratificato Tyvek® con un polimero della DuPont. Il polimero sigilla i pori rendendolo resistente alle particelle e alla penetrazione di molti liquidi. Viene utilizzato come protezione nei confronti di fluidi corporei, sangue e agenti patogeni dello stesso. Caratteristiche della tuta identiche all'articolo TYV2.

TYV3. - tuta Tychem "C", taglie: M - L - XL. **Tipo 3, 4, 5 e 6**

4 TYVEK® CLASSIC XPRT



Tuta colore bianco cucita con cappuccio e cuciture esterne rinforzate; cappuccio in tre pezzi, zip autobloccante, patta della zip in Tyvek®, elastico attorno al viso, ai polsi e alle caviglie, elastico in vita incollato e non cucito. Protegge i lavoratori durante la manipolazione di sostanze chimiche pericolose. La tuta va utilizzata secondo il livello di tossicità della sostanza chimica e le condizioni di esposizione per la protezione delle particelle (tipo 5), dagli spruzzi o spray limitati (tipo 6). Protezione dei liquidi 3 volte superiore.

TYV6. - tuta Tyvek® Classic Xpert, taglie: M - L - XL - XXL. **Tipo 5 e 6**

APPLICAZIONI IN CUI GLI INDUMENTI AD USO LIMITATO IN TYVEK FORNISCONO UNA PROTEZIONE ECONOMICA E AFFIDABILE

COMPATIBILITÀ LAVORI CON PRODOTTI CODICE PRODOTTO

- Interventi su condotte con sostanze pericolose sotto pressione
- Manipolazione di petrolio e solventi, pulitura cisterne
- Manipolazione di polveri, acidi, basi inorganiche e spruzzi di agenti chimici organici
- Manipolazione su sostanze chimiche pericolose liquide

TYV2

- Finitura metalli
- Interventi in presenza di sangue e di virus quali epatite e HIV
- Manipolazione di polveri, acidi, basi inorganiche e spruzzi di agenti chimici organici
- Spruzzatura di solventi nocivi
- Trattamento con erbicidi erogati sotto pressione

TYV3

- Fabbricazione e manipolazione di farmaci e vaccini
- Insetticidi, fertilizzanti, erbicidi
- Manipolazione materiali tossici, eliminazione scorie di condotta
- Placcatura in oro e sabbatura
- Rimozione di amianto
- Verniciatura a spruzzo

TYV4

- Camere bianche
- Contaminazione farmaci di batteri, spore, parassiti del corpo umano
- Ispezioni filtri caldaie
- Manipolazione di sostanze chimiche conosciute (classe 1000)
- Produzione alimentare di cibi destinati a persone o animali

TYV6



IL TYVEK® È UN MATERIALE 100% SINTETICO, REALIZZATO CON FIBRE DI POLIETILENE AD ALTA DENSITÀ, CHE VIENE UTILIZZATO PER SVARIE APPLICAZIONI IN MOLTEPLICI SETTORI INDUSTRIALI. È LEGGERO, ROBUSTO E TRASPIRANTE, MA ALLO STESSO TEMPO RESISTENTE ALL'ACQUA, ALL'ABRASIONE, ALLA PENETRAZIONE BATTERICA E ALL'INVECCHIAMENTO.

Indumento saldato

Indumento cucito



1 SPACEL COMFORT FLAME RETARDANT



Tuta in tessuto non tessuto di Viscosa impregnato, 138 g/m². **Certificata Flame Retardant (EN533/EN14116)**, materiale trattato ignifugo a limitata propagazione di fiamma, antistatica, sviluppato per la protezione contro sostanze chimiche. Cuciture nastrate, doppia patella di chiusura, doppia cerniera, rinforzo alle ginocchia, buona resistenza ai liquidi ed agli strappi. Elastici ai polsi ed alle caviglie, esente da lattice e silicone. Adatta per industria petrolchimica, manutenzioni industriali, decontaminazioni, industria farmaceutica. Disponibile anche in versione non impregnata.

TTB8000. - colore grigio. Taglie: L - XL. **Tipo 3 e 4**

2 DELTASAFE PLUS FLAME RETARDANT



Tuta in tessuto non tessuto Polipropilene 4 strati SMMS - 60 g/m². **Certificata Flame Retardant M1 (EN533/NFP92507)**, materiale trattato ignifugo a limitata propagazione di fiamma, antistatica, ottima resistenza allo strappo, abrasione e perforazione, protezione contro particelle radioattive. Estremamente traspirante, chiusura a doppio cursore. Adatta per industria farmaceutica, nucleare, raffinerie, energia, servizi.

TTB1450. - colore bianco. Taglie: L - XL. **Tipo 5 e 6**



Protezione capo e corpo

Indumenti di protezione parziale del corpo da rischi di lieve entità. DPI di 1^a categoria. Colore bianco.

3 MANICOTTI



Manicotti **in Tyvek** con elastico alle estremità, 100% polietilene 41 g/m².

Confezione da 10 paia.

TYV15 - manicotti in Tyvek, lunghezza cm 40, taglia unica



4 GIUBBINO



Giubbino con cappuccio, cerniera, elastico ai polsi e in vita **in Tyvek**[®].

TYV8. - giubbino, taglie: M - L - XL



5 CAMICE



Due tasche, taschino, collo a camicia, chiusura con velcro **in Tyvek**[®].

TYV7. - camice, taglie: M - L - XL



6 CALZARI



Calzari **in Tyvek**[®] con suola in PVC antiscivolo, laccetti di chiusura ed elastico al ginocchio. **Confezione da 5 paia.** Fornibili a richiesta in Tychem "F" (codice TYV11).

TYV17 - calzari in Tyvek[®] 100% polietilene 41 g/m², misura 34 cm



7 SOVRASCARPE



Sovrascarpe **in Tyvek**[®], suola in PVC antiscivolo, elastico alla caviglia, 100% polietilene 41 g/m². **Confezione da 10 paia.** Fornibili a richiesta in Tychem "F" (codice TYV12).

TYV16 - sovrascarpe in Tyvek[®], misura 34 cm



8 CALOTTA



Calotta sotto elmetto in TNT con elastico alla nuca, 100% polipropilene 40 g/m². **Confezione da 100 pezzi.**

TCK04 - calotta sotto elmetto, taglia unica



9 CUFFIETTE



In polipropilene 18 gr/m² spessore 0,12 mm, cucita. Elastico su tutta la circonferenza. Confezionate in **scatola distributrice da 100 pezzi.**

TCK350 - confezione da 100 cuffiette monouso colore bianco



1 3M™ 4565

Tuta realizzata con pellicola microporosa laminata, cuciture rinforzate con quadruplo filo, termonastratura. Cappuccio a 3 lembi per l'utilizzo con DPI, zip doppia via con patella adesiva, polsi in maglia, elastico in vita e alle caviglie. **Tipo 4, 5 e 6.**

TTM4560. - tuta colore bianco, taglie dalla M alla XXL

2 3M™ 4545

Tuta in tessuto microporoso morbido, resistente e leggero (49 g/m²). Ampia gamma di applicazioni, tra cui in camere bianche. Cappuccio a 3 lembi per l'utilizzo con DPI, zip doppia via con patella adesiva, polsi in maglia, elastico in vita e alle caviglie. **Tipo 5 e 6.**

TTM4545. - tuta colore bianco, taglie dalla M alla XXL

3 3M™ 4532+

Tuta in materiale traspirante in polipropilene, eccellente barriera contro particolato secco e limitati spruzzi di alcune sostanze chimiche liquide. Trattato per aumentare la repellenza ad alcuni oli e solventi. **Tipo 5 e 6.**

TTM4532 - tuta colore blu, taglie dalla M alla XXL

4 3M™ 4520

Tuta molto leggera (43 g/m²) e traspirante per prolungati periodi di indossamento. Cappuccio a 3 lembi per l'utilizzo con DPI, zip doppia via con patella adesiva, polsi in maglia, elastico in vita e alle caviglie. **Tipo 5 e 6.**

TTM4520. - tuta colore bianco, taglie dalla M alla XXL

5 3M™ 4500

Tuta in polipropilene (45 g/m²) uso generico, protezione contro sporco e sostanze non aggressive. Cappuccio, polsi, caviglie e cintura elasticizzati, zip con patella protettiva. CE I categoria.

TTM4500W. - tuta colore bianco, taglie dalla M alla XXL

GUIDA ALLA SELEZIONE				
TIPO DI LAVORO	TTM4520	TTM4532	TTM4545	TTM4565
Ispezione amianto, preparazione impianto, isolamento			■	■
Rimozione di amianto			■	■
Preparazione cemento, smerigliatura e lucidatura metalli	■	■	■	■
Pulizie industriali leggere, manutenzione macchinari	■	■	■	■
Preparazione farmaci, manipolazione polveri tossiche	■	■	■	■
Verniciatura e rivestimenti, resine			■	■
Camere bianche			■	■
Pesticidi spray				■
Manipolazione e miscelatura componenti chimici				■



■ Indumento consigliato
■ Indumento adatto

Protezione capo e corpo



6 CAMICE

Ideale in laboratorio, 100% polipropilene (45 g/m²), chiusura a zip, elastici ai polsi. CE I categoria. Taglie dalla M alla XXL. **TTM4400.** - camice bianco



SOVRASTIVALI

Materiale: PP + PE. Taglia unica. **7 TTM450** - sovrastivali bianchi, suola antiscivolo, confezione da 100 pezzi **8 TTM440** - sovrastivali bianchi, confezione da 200 pezzi



SOVRASCARPE

Confezione da 300 pezzi, taglia unica. **9 TTM402** - sovrascarpe antiscivolo colore blu **10 TTM442** - sovrascarpe tipo 5-6 colore bianco



SOVRAMANICHE

Venduti in confezione da 150 paia, taglia unica. **TTM444** - sovramaniche bianche con polsino elastico

PROTEZIONE DELLE MANI: LE NORME E I TEST



DEFINIZIONE DELLE CATEGORIE DI PROTEZIONE DEI GUANTI DA LAVORO

- **CATEGORIA I > PROTEZIONE RISCHI MINIMI.** Guanti con disegno semplice che proteggono da rischi di basso livello (ad esempio guanti per lavori di pulizia). I produttori sono autorizzati a testare e ad autocertificare i loro guanti.
- **CATEGORIA II > PROTEZIONE RISCHI MEDI,** diversi da quelli elencati nelle categorie I e III. Guanti progettati per proteggere contro rischi di livello intermedio (ad esempio guanti per operazioni generiche di manipolazione che necessitano di resistenza a taglio, perforazione e abrasione). Devono essere sottoposti a test specifici e ottenere la certificazione da un ente notificatore indipendente (CE). Senza l'apposito marchio CE, il guanto non può essere venduto né utilizzato. Il nome e l'indirizzo dell'ente notificatore che certifica il prodotto devono apparire sulle istruzioni per l'uso che accompagnano il guanto.
- **CATEGORIA III > PROTEZIONE RISCHI MOLTO GRAVI,** che possono causare la morte o danni irreversibili alla salute (ad esempio prodotti chimici, agenti biologici, scosse elettriche e lavori sotto tensione). Devono essere testati e certificati da un ente notificatore. Deve essere, inoltre, sottoposto a verifica indipendente del sistema di controllo qualità attuato dal produttore per garantire l'omogeneità della produzione. Il nome e l'indirizzo dell'ente notificatore deve apparire anche sulle istruzioni per l'uso ed essere identificato da un numero che appare accanto al marchio CE.

NORMA EN ISO 21420:2020

Requisiti generali per i guanti protettivi

Questa norma definisce i requisiti generali per il disegno del guanto e la sua costruzione, innocuità, comfort, efficienza e marcatura, nonché le informazioni applicabili a tutti i guanti di protezione. La norma è applicabile anche alle protezioni per le braccia. I livelli di prestazione mostrano i valori ottenuti dal guanto in un test specifico, e i risultati in base ai quali eseguire la valutazione. Il livello 0 indica che il guanto ha fatto registrare un livello di prestazione inferiore al minimo. Valori più alti indicano livelli più alti di prestazione. Un livello di prestazione X indica che il guanto non è stato testato.

NORMA EN 388:2016

Rischi meccanici

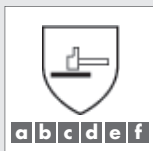

Sintesi dei principali cambiamenti:

- **Abrasione:** nuova carta abrasiva utilizzata nelle prove
- **Taglio:** nuova procedura per il **Coup Test**, in grado anche di determinare se si verifica un effetto di riduzione dell'affilatura della lama. Se si verifica una riduzione dell'affilatura della lama, il metodo di test EN ISO 13997 diventa il riferimento mentre il coup test resta solo indicativo.
- **Impatto:** metodo di prova per le zone dichiarate di protezione contro gli impatti. "P" per superato, nessun codice in caso di prova fallita.

LIVELLO DI PRESTAZIONE

1	2	3	4	5
100	500	2.000	8.000	-
1,5	1,5	5,0	10,0	20,0
10	25	50	75	-
20	60	100	150	-

LIVELLO DI PRESTAZIONE

A	B	C	D	E	F
2	5	10	15	22	30
Superato (P) o fallito (nessuna marcatura)					

a Resistenza all'abrasione (numero di cicli)

b Resistenza al taglio da lama Coup Test (indice adimensionale)

c Resistenza allo strappo (Newton)

d Resistenza alla perforazione (Newton)

e Resistenza al taglio ISO (Newton)

f Protezione contro gli impatti EN

A quanto precede, può anche essere applicato il livello X da (a) a (E), che significa "non testato" o "non applicabile".

NORMA EN16778:2016

Misurare la dimetilformammide (DMF o DMFa) nei guanti

La dimetilformammide, nota anche come DMF, DMFa o DMFo, è un solvente volatile pericoloso per inalazione e che può penetrare la pelle. Al momento non esiste alcuna guida normativa specifica riguardante l'esposizione del contatto dermico. La norma EN 16778 definisce un metodo di prova armonizzato (NON si tratta di un requisito né di un limite) per misurare il contenuto di DMFa nel materiale che costituisce il guanto.

NORME EN ISO 374:2016





Rischi chimici e contaminazione batteriologica

GUANTI DI PROTEZIONE CHIMICA

Il pittogramma "resistente alle sostanze chimiche", sul guanto, deve essere accompagnato da un codice a lettere per i guanti di tipo A e B. I guanti di tipo C sono marcati senza codice a lettere. Le lettere del codice si riferiscono a un elenco di sostanze chimiche definite dalla norma. Il tempo minimo di permeazione per un **guanto di tipo C è di 10 minuti** per una sostanza chimica, per uno di **tipo B è di 30 minuti** per almeno 3 sostanze chimiche, e per il **tipo A è di 30 minuti** per almeno 6 sostanze chimiche nell'elenco.

SOSTANZE CHIMICHE SOTTOPOSTE AL TEST

La tabella di permeazione chimica include ora 6 nuove categorie, classificate da M a T.

EN ISO374-1:2016 TYPE C	EN ISO374-1:2016 TYPE B	EN ISO374-1:2016 TYPE A	
			
	XY Z	UVW XYZ	
Tempo minimo di permeazione: 10 MINUTI per 1 sostanza chimica	Tempo minimo di permeazione: 30 MINUTI per almeno 3 sostanze chimiche	Tempo minimo di permeazione: 30 MINUTI per almeno 6 sostanze chimiche	L'icona del beaker (bassa resistenza chimica/impermeabilità) è stata eliminata

NORMA EN 511

Protezione contro il freddo

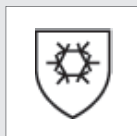

- A: resistenza al freddo convettivo
- B: resistenza al freddo da contatto
- C: impermeabile all'acqua: 1=SI 0=NO

NORMA EN ISO 374-5

Protezione contro i microorganismi



Il pittogramma riguardava, in precedenza, batteri e funghi. La nuova norma impone un nuovo test di penetrazione virale (ISO16604:2004). Se il guanto supera questo ulteriore test, viene aggiunta la parola "VIRUS" sotto il pittogramma.

NORMA EN 421

Protezione contro la contaminazione radioattiva



Specifica requisiti e metodi di prova per i guanti destinati alla protezione dalla contaminazione radioattiva.

NORMA EN 60903:2003

Lavori sotto tensione /isolamento elettrico



La norma si applica ai guanti progettati per proteggere da scosse elettriche durante l'esecuzione di lavori sotto tensione. I guanti isolanti in gomma dovrebbero essere normalmente utilizzati con guanti di protezione in pelle, che vengono indossati sopra i guanti isolanti per conferire protezione meccanica.

NORMA EN 421

Protezione contro radiazioni ionizzanti



Il guanto deve superare la prova d'impermeabilità e subire certe prove specifiche secondo il suo utilizzo.

NORMA EN 407

Protezione contro calore e/o fuoco



- A: resistenza alla fiamma
- B: resistenza al calore da contatto
- C: resistenza al calore convettivo
- D: resistenza al calore radiante
- E: resistenza a piccole proiezioni di metallo liquido
- F: resistenza a grosse proiezioni di metallo fuso

NORMA EN 12477:2006

Protezione contro la saldatura



Questa norma si applica ai guanti protettivi da utilizzare per saldatura manuale, taglio e processi connessi.





GUANTI PER RISCHIO MECCANICO - II^A CATEGORIA



1 PU 18

Guanto in poliammide, rivestimento del palmo in poliuretano. Adatto nei settori: manifattura in generale, logistica, edilizia, falegnameria, elettronica ed hobbistica. Assenza di silicone. Taglie (EN): dalla XS alla XXL. Confezionati al paio in pratiche buste. Minimo ordinabile 10 paia/multipli.

GER018. - guanto PU18, lunghezza mm 240, colore grigio

2 PU 13

Guanto in maglia sintetica a filo continuo senza cuciture, spalmati in poliuretano. Polsino elasticizzato e dorso e dita a rete. Buona destrezza, presa e resistenza meccanica. Taglie (EN): dalla S alla XXL. Confezionati al paio in pratiche buste. Minimo ordinabile 10 paia/multipli.

GER013. - guanto PU13, lunghezza mm 240, colore nero

3 ERGO PREMIUM

Guanto in maglia di poliammide e Lycra grigio con rivestimento in microschiuma di nitrile nero, sul palmo e sulla punta delle dita. Confortevole, buona resistenza all'abrasione. Ottima presa in ambienti grassi e oleosi. Indicato per lavori di precisione. Taglie EN: 6, 7, 8, 9, 10, 11. Minimo ordinabile 12 paia/multipli.

GEE8084/. - guanto Ergo Premium, elastico al polso, colore grigio/nero

4 ERGO GRIP

Guanto in maglia HPPE senza cuciture e con rivestimento in nitrile sul palmo e sulle punta delle dita. Elevata resistenza al taglio, ottima presa in ambienti grassi e oleosi. Rinforzo pollice/indice. **Protezione durante la manipolazione di parti taglienti e abrasive e contro rischio alto di tagli.** Taglie EN: 6, 7, 8, 9, 10, 11. Minimo ordinabile 10 paia/multipli.

GEE8309/. - guanto Ergo Grip, elastico al polso, colore blu/nero



5 N16 MS

Guanto in Spandex, materiale che aumenta l'elasticità limitando il passaggio dei liquidi. Rivestimento del palmo in **nitrile Microsandy**, che conferisce ottima presa e oleo/idrorepellenza. Particolarmente adatto nei settori: carrozzeria, verniciatura, manifattura, logistica, edilizia e hobbistica. Assenza di silicone. Dorso aerato. Taglie (EN): dalla S alla XXL. Minimo ordinabile 10 paia/multipli.

GER016. - guanto N16 MS, lunghezza mm 240 colore nero

6 N22

Guanto in maglia HPPE con proprietà antitaglio, più elastico e poliammide che lo rendono elastico e confortevole. Rivestimento del palmo in **doppio bagno di nitrile Microsandy** per un'ottima presa ed elevata oleo/idro repellenza. Dorso aerato. Settori: carrozzeria, lastratura, verniciatura, manifattura, logistica, edilizia e hobbistica. Taglie (EN): dalla S alla XXL, minimo ordinabile 10 paia/multipli.

GER023. - guanto N22, lunghezza mm 240, colore nero

7 ATHLETIC D5 XP

Guanti in HPPE, acciaio, poliammide/elastane con rivestimento in microschiuma, NBR, palmo immerso. Resistenti al taglio (Livello D), flessibili, ottima vestibilità. Ottima presa in condizioni asciutte, oleose e bagnate, ottima resistenza all'abrasione. Rinforzo nell'area del pollice. Funzionalità touchscreen. Settori: lavorazione di metalli, manutenzione, imballaggio, edilizia.

GPU6030/. - guanti Athletic D5 XP, taglie (EN): dalla 8 alla 11

8 BAMBOO TWINFLEX

Guanti in Bamboo TwinFlex®, tecnologia brevettata che garantisce il massimo comfort alla pelle. Morbida vestibilità, rapido assorbimento dell'umidità. Ottima presa in condizioni asciutte e leggermente umide/oleose. Eccellente resistenza all'abrasione, rinforzo nell'area del pollice. Funzionalità touchscreen. Resistenza al taglio (livello D).

GPU6090/. - guanti Bamboo Twinflex, taglie (EN): dalla 8 alla 12



EN388:2016
3131A

1 HYFLEX 11-800™ Ansell

Guanti in filo, rivestimento di schiuma di **nitrile**. Sottili, flessibili, confortevoli, nessuna cucitura. Valida resistenza alle abrasioni e ai tagli. Rivestimento senza silicone. Particolarmente indicati per lavori di precisione. Taglie (EN): 7 - 8 - 9 - 10. **Minimo ordinabile 12 paia/multipli.**

GE11800/. - guanti lunghezza mm 200 - 270, colore bianco/grigio



EN388:2016
4131A
X1XXXX

1 HYFLEX 11-840™ Ansell

Guanti con rivestimento schiuma di nitrile di qualità premium. La comoda fodera offre una migliore vestibilità (sensazione di una seconda pelle - maggiore destrezza). Privi di silicone, confortevoli, senza cuciture. Indicati per lavori di precisione. Taglie (EN): 7 - 8 - 9 - 10. **Minimo ordinabile 12 paia/multipli.**

GE11840/. - guanti lunghezza mm 200 - 275, colore grigio/nero



EN388:2016
4121A

3 HYFLEX 11-900™ Ansell

Guanti per uso generale, con palmo rivestito in **nitrile** e fodera di poliammide in filo continuo. Sottili, flessibili, confortevoli, nessuna cucitura. Buona presa su parti oleate, ideali per manipolazioni di plastica, gomma, metallo. Buon grado di resistenza alle abrasioni. Taglie (EN): 7 - 8 - 9 - 10. **Minimo ordinabile 12 paia/multipli.**

GE11900/. - guanti lunghezza mm 200 - 255, colore bianco/blu



EN388:2016
4121A

4 EDGE™ 48-128 Ansell

Guanti economici in poliestere rivestiti di **nitrile**. Leggeri e confortevoli, elevato livello di destrezza e flessibilità, buon livello di abrasione e resistenza all'olio. Adatto per: assemblaggio, manipolazioni, confezionamento, controllo qualità. **Minimo ordinabile 12 paia/multipli.** Taglie (EN): 7 - 8 - 9 - 10.

GE48128/. - guanti lunghezza mm 270, colore nero



EN388:2016
4131A

HYFLEX 48-100™ E 48-101™ Ansell

Realizzati a filo continuo rivestito in **poliuretano**. Ottima presa asciutta e bagnata. Adatti per: imballaggio, assemblaggio, manipolazione minuterie. **Minimo ordinabile 12 paia/multipli.** Lunghezza mm 250. Taglie (EN): 8 - 9 - 10.

5 GE48100/. - guanti bianchi
6 GE48101/. - guanti neri



EN388:2016
2131X

7 N12 reflex

Guanto in maglia sintetica a filo continuo senza cuciture, spalmati esternamente in nitrile. Polsino elasticizzato e dorso e dita areate, buona destrezza, presa e resistenza meccanica. Taglie (EN): dalla S alla XXL. Confezionati al paio in pratiche buste. **Minimo ordinabile 10 paia/multipli.**

GER012/. - lunghezza mm 240, colore bianco

Guanti per lavori leggeri



EN388:2016
2141X

8 GUANTI IN POLISTERE

Guanto a maglia filo continuo 100% poliestere, **palmò puntinato PVC**. Taglie (EN): dalla 6 alla 10. A norma EN388:2003.

GC208/. - guanti puntinati, minimo ordinabile 12 paia/multipli



GUANTI IN COTONE A NORMA EN420:2003

9 GC210/10 - guanti in tela di cotone con palmo e ritorno pollice, indice e mignolo puntinati in PVC. Polsino elasticizzato. Lunghezza 26 cm, larghezza 11,5 cm. **Minimo ordinabile 12 paia/multipli.** Taglia unica (EN): 10

10 GC218. - guanto ambidestro 100% cotone, manichetta elasticizzata. **Minimo ordinabile 10 paia/multipli.** Taglie (EN): S (6 - 7^{1/2}) - L (8 - 9^{1/2})



GUANTI CON RESISTENZA AL TAGLIO - II^a CATEGORIA



1 HYFLEX®
11-724

Guanti ultraleggeri in HPPE e Spandex con palmo rivestito in **poliuretano**, che conferisce ai guanti flessibilità e calzabilità, oltre a una presa salda su oggetti asciutti o leggermente oleosi. Il rivestimento resiste alle abrasioni e allunga la durata del guanto. Taglie (EN): 7 - 8 - 9 - 10. **Minimo ordinabile 12 paia/multipli.**

GE11724/. - lunghezza mm 208 - 261, **II^a categoria**



2 HYFLEX®
11-735

Guanti ultraleggeri in filato INTERCEPT™ con palmo rivestito in **poliuretano** e fodera in fibra di vetro, HPPE, Nylon e Spandex. Rivestimento grigio, elevata resistenza ai tagli, indicati nell'industria automobilistica, metallurgica e chimica. Taglie (EN): 7 - 8 - 9 - 10. **Minimo ordinabile 12 paia/multipli.**

GE11735/. - lunghezza mm 224 - 269, **II^a categoria**



3 HYFLEX®
11-561™

Guanti con rivestimento in **nitrile** per lavori medio-leggeri. La scelta migliore quando servono destrezza e alta resistenza al taglio in condizioni da asciutte a leggermente oleose. Il rinforzo tra pollice e indice aumenta la protezione ed allunga la durata del guanto. **Minimo ordinabile 12 paia/multipli.**

GE11561/. - lunghezza mm 285



4 EDGE®
48-707

Guanti con palmo rivestito in **poliuretano** e fodera in poliestere, fibra di vetro, Spandex, nylon, HPPE. Per applicazioni medie che richiedono resistenza contro taglio e abrasione in ambienti asciutti e leggermente oleosi. Taglie (EN): 7 - 8 - 9 - 10. **Minimo ordinabile 12 paia/multipli.**

GE11727/. - lunghezza mm 220 - 270, **II^a categoria**



EDGE™ 48-706
E 48-711

Guanti a filo continuo rivestiti di **nitrile**. Buona presa, resistenza al taglio e all'abrasione. Adatti per: industrie automobilistiche e metallurgiche. **Minimo ordinabile 12 paia/multipli.** Taglie (EN): 7 - 8 - 9 - 10.

5 GE48706/. - per applicazioni gravose, lunghezza mm 270

6 GE48711/. - per applicazioni medie, lunghezza mm 280



EDGE®
48-929 E 919

Guanti con polso a maglia elasticizzata, fodera senza cuciture, interamente rivestiti di NBR, per una presa sicura in ambienti oleosi. **Minimo ordinabile 12 paia/multipli.** Taglie (EN): 7 - 8 - 9 - 10.

7 GE48929/. - per applicazioni medie, lunghezza mm 270

8 GE48919/. - per applicazioni leggere, lunghezza mm 270



9 SYNEXO
IMPACT

Guanti robusti in HPPE, fibra di vetro e nylon, per settore Oil & Gas, minerario e lavori di costruzione pesanti. Chiusura al polso con velcro, palmo extra imbottito, protezioni in TPR per ossa e articolazioni. Ottimo grip, elevata resistenza al taglio. **Minimo ordinabile 10 paia/multipli.** Taglie (EN): 9 - 10.

GKU598/. - guanti colore verde



10 GUANTI
PROFLEX®
922 CR

Guanti Proflex® 922 CR resistenti al taglio in maglia HPPE calibro 13, senza cuciture. Protezione dorsale in TPR e palmo in nitrile rinforzato e antiscivolo. **Particolarmente indicati per il settore Oil & Gas.**

EDS922 - guanti antitaglio 922 CR, taglie fornibili: M / L / XL



EN388:2016
2 5 4 X
EN407
X 1 X X X X



EN388:2016
4 X 4 2 C



EN388:2016
4 X 4 2 C
EN407
X 1 X X X X



EN388:2016
2 X 4 X C

PRODOTTI ANALLERGICI

1 GUANTI ANTITAGLIO E ANTICALORE



Guanti in maglia in composito e filato in Para-aramide. Offrono aderenza, presa elevata, resistenza al calore, protezione contro il taglio. Ambidestri. Taglie (EN): dalla 7 alla 10. A norma EN388 - EN407. **GK2522/.** - guanti, lunghezza mm 250

2 GUANTI PU22 CUT PROTECTION



Guanto II^a categoria in maglia HPPE, elastan e poliammide. Rivestimento del palmo in poliuretano. Adatto per: carrozzeria, lastratura, verniciatura, manifattura, logistica ed edilizia. Senza silicone. Taglie (EN): dalla XS alla XXL. Minimo ordinabile 10 paia/multipli. **GER002/.** - lunghezza mm 240

3 GUANTI E MANICHETTA ANTITAGLIO



Guanto di protezione antitaglio in Dyneema®, fibra di vetro e poliammide, rivestimento in nitrile (HPE). Taglie (EN): 7 - 8 - 9 - 10. Manichetta di protezione antitaglio in fibra di vetro, poliammide, filato di bamboo e Dyneema®. Traspirante, taglia unica. **Minimo ordinabile 10 paia/multipli.**
3 GKU494/. - guanto antitaglio, lunghezza mm 270
4 VPU6491 - manichetta antitaglio, lunghezza mm 400

Guanti antifreddo



EN388:2016
2 2 3 1 X



EN388:2016
2 2 3 1 C
EN407
X 2 X X X X
EN511
0 2 0



EN388:2016
2 1 4 X A
EN407
X 1 X X X X
EN511
0 1 0



EN388:2016
2 2 3 1 B
EN511
1 2 X



EN388:2016
4 1 3 1 A
EN511
0 1 0

5 PROFLEX® 816



Muffole convertibili in mezziguanti, risolto delle estremità delle dita rimovibile. Interno in micro PVC (massima protezione contro escursioni termiche), esterno in poliestere. Palmo antiscivolo con doppio strato di pelle sintetica, fascia riflettente. Facili da sfilare. Taglie fornibili: M / L / XL. **EDS816.** - guanti termici Proflex® 816 colore nero

6 POWERFLEX T HI VIZ™



Mantengono le mani calde fino a -30° C. Sintetico in filo continuo, fodera termica acrilica altamente isolante, rivestimento di lattice. Presa sicura su oggetti asciutti e bagnati. Adatti per operazioni di manipolazione e trasporto. **Minimo ordinabile 12 paia/multipli.** Taglie (EN): 7 - 8 - 9 - 10. **GE80400/.** - lunghezza mm 250 - 295, II^a categoria

7 ACTIVARMR™ 78101



Guanti termici a filo continuo, leggeri ed elasticizzati, utilizzabili anche come sottoganti. Aderiscono perfettamente alla mano. Ambidestri, adatti in edilizia, manutenzione e per proteggere dal freddo. **Minimo ordinabile 12 paia/multipli.** Taglie (EN): 7 - 9. **GE78101/.** - lunghezza mm 240 - 260, II^a categoria

8 ACTIVARMR™ 97631



Guanti termici a due strati: fodera esterna in nylon, interno in acrilico. Polso a maglia, palmo rivestito in PVC (più flessibile alle basse temperature), elevato livello di destrezza, approvati per l'industria alimentare. **Minimo ordinabile 12 paia/multipli.** Taglie (EN): 7 - 9. **GE97631/.** - lunghezza mm 250 - 285, II^a categoria

9 ACTIVARMR™ 97-011



Guanti termici con rivestimento in nitrile. La finitura sabbata consente la manipolazione di materiali bagnati e oleosi, mentre la fodera in acrilico e poliestere permette di avere le mani sempre calde anche in condizioni di freddo estremo (fino a -20°C), proteggendole da tagli e abrasioni. **Minimo ordinabile 12 paia/multipli.** Taglie (EN): 8 - 9 - 10 - 11. **GE97011/.** - lunghezza mm 240 - 275, II^a categoria



GUANTI IN MAGLIA METALLICA, PER SALDATURA E ANTICALORE



EN388:2016
3 1 4 3 X
EN407:2016
4 1 3 2 4 X



EN388:2016
2 2 4 1 B
EN407
X 2 X X X X



1 GUANTI IMBOTTITI PER SALDATURA



Guanti in pelle fiore bovina. Taglia abbondante che evita lo sfilamento rapido del guanto. Fodera di cotone Jersey resistente alle alte temperature. Morbidi e resistenti, cuciture in Kevlar, elastico protetto al polso. Indicati per tutti i procedimenti di saldatura ad arco, molatura, smerigliatura, saldatura MIG con calore e scorie. **A norma EN420 - EN388 - EN407 - EN12477.** Taglia unica (EN) 10.

TAS1910/10 - guanti per saldatura, lunghezza mm 350

2 GUANTI CRUSADER FLEX™



IIIª categoria. Isolamento in feltro e barriera termica su tutta la lunghezza. Adatti per manipolazioni intermittenti di oggetti molto caldi fino a 250°C. Il rivestimento impregnato in nitrile protegge contro strappi, perforazioni, abrasioni e tagli. Taglie (EN): 9 - 10. **Minimo ordinabile 12 paia/multipli.**

GE42474/. - guanti lunghezza mm 330

GE42445/. - guanti lunghezza mm 240

CHAINEX



Realizzati con una lavorazione semi-artigianale di alto livello, massima protezione dai tagli in condizioni di lavoro estremamente pericolose. Robusti e durevoli, offrono leggerezza e comfort anche per usi prolungati.

3 GEH0302/. - guanto singolo reversibile, cinghia regolabile in tessuto, chiusura con bottoni. Taglie (EN): dalla 8 alla 10. **A norma EN1082**

4 GEH0303 - grembiule con bretelle tessili e cintura, moschettoni in materiale plastico. Dimensioni 700 x 450 mm. **A norma EN13998**



21 4 2
4 2 3 X 3 X



2 2 4 3
4 2 3 4 4 X



2 5 4 3 C X
4 3 3 4 4 4



3 2 3 3 4 4

5 GUANTI ANTICALORE IIIª CATEGORIA



Guanti IIIª categoria in tessuto di fibra 100% para aramidico, foderato in tessuto TNT ignifugo. Taglia 10. **A norma: EN420 - EN388 - EN407.**

GA2028 - guanti anticalore, lunghezza mm 280

GA2040 - guanti anticalore, lunghezza mm 400

6 GUANTI ANTICALORE IIIª CATEGORIA



Guanti IIIª categoria in tessuto di fibra para aramidica alluminizzata coibentati con tessuto ignifugo. Taglia 10. **A norma: EN420 - EN388 - EN407.**

TAA4028 - guanti anticalore, lunghezza mm 280

TAA4040 - guanti anticalore, lunghezza mm 400

7 GUANTI ANTICALORE IIIª CATEGORIA



Guanti tipo 2 IIIª categoria con palmo in tessuto diagonale 100% para aramidico, dorso e manico in tessuto aramidico alluminizzato coibentato. Taglia unica. **A norma: EN420 - EN388 - EN407.**

GA5035 - guanti anticalore, lunghezza mm 350

8 GUANTI ANTICALORE PER VIGILI DEL FUOCO



Guanti IIIª categoria resistenti al calore, palmo e dorso in nappa bovina da 1,3-1,5 mm resistente alla fiamma. Manichetta in crosta, polso elasticizzato, rinforzo proteggi arterie, alamaro regolabile con velcro. Guanto interno in 100% maglia para-aramidica. Cuciture in filo Kevlar. Taglie (EN): 9 - 10. **A norma: EN420 - EN388 - EN407 - EN659: 2003+ A1:2008.** Lunghezza mm 380.

GA2049/. - guanti anticalore



EN388:2016
3123X



EN388:2016
4124X



EN388:2016
4144X



NEW



GUANTI ANTIVIBRAZIONE
A PAGINA 268.

1 GUANTI IN PELLE CROSTA

Guanti sfoderati completamente in pelle crosta, manichetta mm 70. Lunghezza mm 270. Taglia unica (EN): 10. **Minimo ordinabile 12 paia/multipli.**

GP102 - guanti in pelle crosta, a norma EN388:2003

2 GUANTI IN PELLE FIORE

Guanti sfoderati, palmo e dorso in pelle fiore bovino, elastico stringipolso orlato al fondo. Taglie (EN): 8 - 9 - 10. **Minimo ordinabile 12 paia/multipli.**

GP140/. - guanti in pelle fiore bovino, a norma EN388:2003

3 GUANTI PALMO CROSTA

Guanti sfoderati palmo crosta, dorso e manichetta in tela. Lunghezza mm 270. Taglia unica (EN): 10. **Minimo ordinabile 12 paia/multipli.**

GP104 - guanti palmo crosta, a norma EN388:2003

4 SUPPORTO CON CLIP PER GUANTI

Per tenere a portata di mano maschere, guanti, DPI e asciugamani prevenendo la caduta e la perdita di oggetti. Durevole e resistente, ideale per magazzini, manifatture edilizia, pulizie etc. Può essere agganciato alla cintura, ai vestiti o ai moschettoni. Resistenza alla rottura: 11,8 kg.

EDS001 - supporto per guanti mm 160 x 25



EN388:2016
4121B



6



7



EN388:2016
3111A



EN388:2016
3111A



EN388:2016
2142B

ACTIVARMR[®] HYCRON[®] Ansell

Guanti per lavori pesanti in fodera di jersey rivestita di **nitrile**. Polso e dorso a maglia, ottima resistenza a tagli, strappi, perforazioni, grasso e olio, ottima presa su oggetti asciutti. Lavabili in lavatrice. Adatti per lavori gravosi: edilizia, attività meccaniche in genere, manutenzioni. **Minimo ordinabile 12 paia/multipli.**

5 GE27600/8 - lunghezza mm 260, taglia (EN): 8
GE27600/10 - lunghezza mm 275, taglia (EN): 10

6 GE27805/. - lunghezza mm 260, con manichetta di sicurezza, interamente rivestito. Taglie (EN): 9 - 10

7 GE27607/. - lunghezza mm 260, con manichetta di sicurezza, dorso a maglia. Taglie (EN): 9 - 10

8 HYNIT[®] 32-815 Ansell

Guanti per lavori pesanti in fodera di cotone poliestere rivestita di **nitrile**. Eccellente resistenza all'abrasione, respinge olio, grasso e sporco. Ideali per: assemblaggi, manipolazioni generali, barre di acciaio, lamiere, lattine e altri lavori metallici, confezionamento, manutenzione. **Minimo ordinabile 12 paia/multipli.**

GE32815/. - lunghezza mm 265, taglia (EN) 7 - 8 - 9 - 10

9 ACTIVARMR[®] HYLITE[®] 47-400 Ansell

Guanti in fodera di cotone Interlock rivestita di **nitrile**. Per lavori medio-leggeri: imballaggio, assemblaggio, lavorazione di metalli leggeri, taglienti e con sbavature, spedizione e ricezione merci, manutenzione. **Minimo ordinabile 12 paia/multipli.** Taglie (EN): 7 - 8 - 9 - 10.

GE47400/. - lunghezza mm 270

10 ACTIVARMR[®] 80-100 Ansell

Per uso generale. Fodera in filo continuo di cotone rivestita in **lattice**. Nessuna cucitura, esente da siliconi, morbido, sensibile, traspirante, confortevole con finitura rugosa. **Minimo ordinabile 12 paia/multipli.** Taglie (EN): 8 - 9 - 10.

GE80100/. - lunghezza mm 245, colore blu



GUANTI PER RISCHIO CHIMICO - III^a CATEGORIA



EN374-1-2016
tipo B
K P T

EN374-5-2016



EN388-2016
2 1 2 1 X

EN374-1-2016
tipo B
J K L N P T

EN374-5-2016
VIRUS



EN388-2016
+ AI-2018
4 1 0 1 X

EN374-1-2016
tipo A
J K L O P T

EN374-5-2016
VIRUS



EN388-2016
2 1 0 1 X

EN374-1-2016
tipo B
K O P T

EN374-5-2016

1 GUANTI R94



Guanti in lattice senza polvere di alta qualità. Doppio strato di lattice per maggiore resistenza su palmo/dita. Clorinati esternamente, con zigrinatura antiscivolo. Felpatura interna in morbido cotone. Adatti per: industria leggera, industria pesante, pulizie. Taglie (EN): dalla S alla XL. Riutilizzabili, confezionati al paio in pratiche buste. Minimo ordinabile 10 paia/multipli.

GER094. - lunghezza mm 330, colore giallo/blu

2 GUANTI 97 HD



Guanti in nitrile con leggera felpatura interna, clorinati internamente per una facile calzatura del guanto e per ridurre il rischio di allergie alle proteine del lattice, zigrinatura antiscivolo. Ottima resistenza chimica e meccanica. Adatti per: industria chimica, grafica, elettronica. Taglie (EN): dalla M alla XXL. Confezionati al paio in pratiche buste. Minimo ordinabile 10 paia/multipli.

GER097/. - lunghezza mm 330, colore verde

3 GUANTI 101 HD



Guanti in neoprene e lattice, leggera felpatura interna, clorinati esternamente, zigrinatura antiscivolo. Buona resistenza chimica e meccanica. Adatti per: industria chimica e petrolifera, manutenzione e pulizie industriali, agricoltura. Taglie (EN): dalla M alla XXL. Confezionati al paio in pratiche buste. Minimo ordinabile 10 paia /multipli.

GER101/. - lunghezza mm 320, colore nero

4 GUANTI 95 FH



Guanto in nitrile ideale per l'industria alimentare nei casi in cui si debbano manipolare alimenti con superfici appuntite o spigolose. Clorinatura interna. Zigrinatura antiscivolo sulle dita. Senza felpatura. Taglie (EN): dalla S alla XL. Confezionati al paio in pratiche buste. Minimo ordinabile 10 paia/multipli.

GER095/. - lunghezza mm 330, colore blu



EN388-2016
3 1 2 1 B

AlphaTec®
EN374-1-2016
tipo A
A K L M P T

EN407:2004
X 1 X X X X

EN374-5-2016

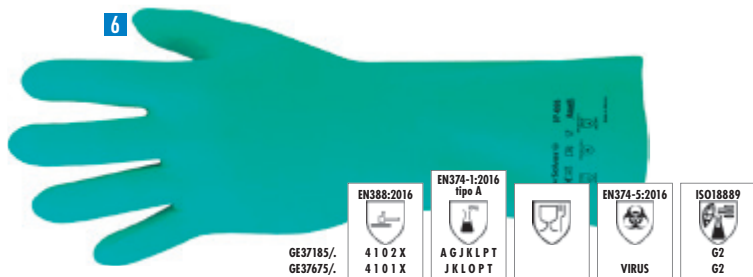

EN388-2016
4 1 0 2 X
4 1 0 1 X

EN374-1-2016
tipo A
A G J K L P T
J K L O P T

EN374-5-2016
VIRUS

ISO18889
G2
G2

GE37185/.
GE37675/.

5 ALPHATEC™ 09924 E 09928



Guanti con fodera di jersey rivestita in **neoprene**. Resistenti a strappi e abrasione, finitura liscia per un'eccellente resistenza chimica ad ampio spettro. Forma anatomica. Adatti per: industria petrolchimica, sgrassatura, lavorazione di materiali metallici, laminazione, applicazioni generiche e gravose e in presenza di prodotti chimici. **Minimo ordinabile 12 paia/multipli.** Taglia unica (EN): 10.

GE9924/10 - lunghezza mm 355

GE9928/10 - lunghezza mm 455

6 ALPHATEC SOLVEX™ 37185 E 37675



Guanti in **nitrile** senza fodera, alta resistenza meccanica e chimica. Anatomici, finitura del guanto per presa sicura. Adatti per: industria chimica, grafica, elettronica, verniciatura, mobilifici, sgrassaggio. **Minimo ordinabile 12 paia/multipli.** Taglie (EN): 7 - 8 - 9 - 10 - 11.

GE37185/. - interno liscio, lunghezza mm 455, spessore mm 0,56

GE37675/. - interno felpato, lunghezza mm 330, spessore mm 0,38



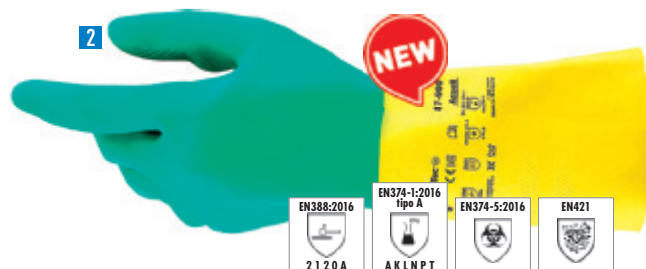

**1 ALPHATEC™
29-500**



Guanti in neoprene per mansioni di media gravosità. Felpatura di lanugine di cotone, morbido, comodo e assorbente. Ideale per l'impiego in atmosfere fredde, alta resistenza chimica contro acidi, sostanze caustiche, alcali e molti solventi. Adatti per: industria automobilistica, manutenzione e manipolazione di sostanze chimiche. Colore nero. **Minimo ordinabile 12 paia/multipli.** Taglie (EN): 7 - 8 - 9 - 10 - 11.

GE29500/. - lunghezza mm 300, spessore mm 0,7

**2 ALPHATEC™
87-900**



Guanti pesanti bicolore in gomma naturale e neoprene, con finitura a rombi in rilievo. Robusti, durevoli, con eccellente presa su oggetti asciutti e bagnati. Fodera floccata in cotone per ridurre il rischio di irritazioni. Adatti per manutenzione macchinari, operazioni di pulizia e manipolazione di sostanze chimiche. Colore verde/giallo. **Minimo ordinabile 12 paia/multipli.** Taglie (EN): 7.5 - 8 - 9 - 10 - 11.

GE87900/. - lunghezza mm 325, spessore mm 0,7

**3 ALPHATEC™
87-955**



Guanti pesanti in lattice naturale senza fodera, floccatura interna in cotone. Alta resistenza chimica contro acidi, chetoni, sali, detergenti, alcool, alcali e grasso animale. Finitura esterna a rombi. Adatti per: raffinazione industria chimica, agricoltura, manutenzioni industriali, manipolazioni gravose. Colore arancio. **Minimo ordinabile 12 paia/multipli.** Taglie (EN): 7 - 8 - 9 - 10.

GE87955/. - lunghezza mm 320, spessore mm 0,75

**4 ALPHATEC™
87-600**



Guanti leggeri in **lattice naturale** senza fodera. Basso contenuto di proteine, idonei a chi soffre di allergie al lattice. Eccellente sensibilità ed elasticità, buona resistenza ai prodotti chimici. Adatti per: industria farmaceutica, elettronica e elettrotecnica, manutenzione e pulizia industriale, protezione del prodotto, maneggio di manufatti in fibra di vetro. **Minimo ordinabile 12 paia/multipli.** Colore naturale. Taglie (EN): 7 - 8 - 9 - 10.

GE87600/. - lunghezza mm 305, spessore mm 0,43



**5 ALPHATEC™
62-401**



Guanti in lattice di gomma naturale, fodera cotone Jersey, finitura increspata. Ideali per mansioni gravose. Ottima flessibilità. Eccellente isolamento termico (fino a 250°C) o freddo (fino a -20°C). **Minimo ordinabile 6 paia/multipli.** Taglia (EN): 8 - 9 - 10.

GE62401/. - lunghezza mm 320

**6 ALPHATEC™
29-500**



Guanti in **neoprene** senza fodera, proteggono da una vasta gamma di prodotti chimici. Finitura esterna a rombi. Trattamento Sanitized®/Actifresh®. Adatti per: industria chimica e petrolifera, manutenzioni e pulizie industriali, agricoltura, attività medio gravose. **Minimo ordinabile 12 paia/multipli.** Taglie (EN): 7 - 8 - 9 - 10.

GE29500/. - lunghezza mm 300, spessore mm 0,70

**7 ALPHATEC™
58-530 / 58-535**



Guanti in **nitrile verde/nero** rivestiti di polimero con fodera di filo continuo senza cuciture. Finitura ruvida, ergonomici. Adatti per: manipolazioni leggere/medio pesanti di oggetti scivolosi bagnati di sostanze chimiche. Non usare contro fiamme e temperature inferiori a -25°C o superiori a 100°C. **Minimo ordinabile 12 paia/multipli.** Taglia (EN): 8 - 9 - 10.

GE58530/. - lunghezza mm 305
GE58535/. - lunghezza mm 356

8 MICROFLEX® 93-260



Guanti in **triplo strato nitrile** neoprene senza polvere. Materiale extrasofo, disegno ergonomico. Molto resistente alle sostanze chimiche aggressive. Adatti per: assemblaggio, manutenzione e riparazione attrezzature, cambio olio e fluidi, miscelazione di sostanze solide liquide, trasferimento di sostanze fra recipienti, cisterne e attrezzature di processo. **Minimo ordinabile 50 pezzi/multipli.** Taglia (EN): da XS a XXL.

GE93260. - lunghezza mm 295

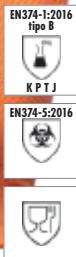

1 GUANTI N85 III^A CATEGORIA



Guanti in nitrile senza polvere ultra resistenti e robusti. Grip 3D su tutto il palmo e le dita per una presa ottimale anche sul bagnato o in presenza di olio. Idoneo nel settore della meccanica e automotive. Monouso, ambidestri, 100% latex free. Taglie (EN): dalla M alla XXL. Confezione dispenser da 50 pezzi. Minimo ordinabile 1 dispenser/multipli. Lunghezza mm 240.

GER085. - guanto colore arancio
GER086. - guanto colore nero



2 GUANTI R70 III^A CATEGORIA



Guanti in nitrile ambidestri, 100% senza lattice, internamente clorinati. Finitura microruvida per aumentare la presa e la sensibilità tattile. L'assenza di polvere riduce il rischio di dermatiti. Ideali per industria leggera, alimentare, laboratori, primo soccorso. Taglie (EN): dalla S alla XXL. Confezione dispenser da 100 pezzi. Minimo ordinabile 1 dispenser/multipli.

GER070/. - lunghezza mm 240, colore azzurro



3 GUANTI R76 III^A CATEGORIA



Guanti in nitrile senza polvere. Composizione "Soft" per maggiore morbidezza, elasticità e sensibilità. Dispositivo Medico in ambito ospedaliero e dentale EN 455 1, 2, 3 & 4. Monouso, ambidestri. 100% Latex Free. Taglie (EN): dalla XS alla XL. Confezione dispenser da 100 pezzi. Minimo ordinabile 1 dispenser/multipli.

GER076/. - lunghezza mm 240, colore azzurro



4 GUANTI R68 III^A CATEGORIA



Guanti in nitrile senza polvere. Spessore maggiorato, resistenza meccanica superiore. Finitura ruvida. Dispositivo Medico in ambito ospedaliero e dentale EN 455 1, 2, 3 & 4. Monouso, ambidestri. 100% Latex Free. Taglie (EN): dalla S alla XL. Confezione dispenser da 100 pezzi. Minimo ordinabile 1 dispenser/multipli.

GER068/. - lunghezza mm 240, colore verde



5 GUANTI "HI-RISK" 98 HR III^A CATEGORIA



Guanti ad altissima resistenza grazie al peso di 18,5 gr, monouso, ambidestri. Internamente clorinati per ridurre il rischio di allergie e dermatiti, finitura microruvida per aumentare la presa e la sensibilità tattile. Adatti per per automotive, industria leggera, laboratori, ambulanze e pulizie. Taglie (EN): dalla S alla XXL. Confezione dispenser da 50 pezzi. Minimo ordinabile 1 dispenser/multipli.

GER09. - lunghezza mm 300, colore blu



6 GUANTI "HI-RISK" 99 III^A CATEGORIA



Guanti in nitrile senza polvere ad alta resistenza. **Spessore maggiorato** per resistenza meccanica superiore, finitura micro ruvida per aumentare presa e sensibilità tattile. Dispositivo medico in ambito ospedaliero e dentale EN 455 1, 2, 3 & 4). Monouso, ambidestri. 100% Latex free. Taglie (EN): dalla S alla XXL. Confezione dispenser da 50 pezzi. Minimo ordinabile 1 dispenser/multipli.

GER099. - lunghezza mm 290, colore blu



7 GUANTI T22 I^A CATEGORIA



Guanti in termoplastici elastomeri senza polvere, monouso, ambidestri ideati per alimenti, superficie zigrinata per maggiore presa e sensibilità. Spessore maggiorato per ottima resistenza, calzata veloce (utilizzabile anche come sovraguanto). Taglie (EN): dalla S alla L. Confezione dispenser da 200 pezzi, minimo ordinabile 1 dispenser/multipli.

GEK022. - lunghezza mm 270, colore blu





1



2



3



1 NEO TOUCH 25-101 III^A CATEGORIA



Guanti monouso in **neoprene**, senza polvere per ridurre il rischio di dermatiti. Rivestimento interno in poliuretano, eccellente comfort, flessibilità e resistenza alla perforazione. Ottima protezione chimica contro acidi, basi ed alcali. Presa ottimale su oggetti asciutti e bagnati. Adatti per: industria farmaceutica, chimica, agricoltura/viticultura. Spessore mm 0,13. Taglie (EN): S (6^{1/2},7) - M (7^{1/2},8) - L (8^{1/2},9) - XL (9^{1/2},10). Venduti in sacchetto dispenser da 100 pezzi.

GEK25101 - lunghezza mm 240

2 TOUCH N TUFF™ 69-318 III^A CATEGORIA



Guanti in **lattice di gomma naturale** ambidestri, con proprietà superiori di flessibilità delle dita e presa. Adatti per: analisi di laboratorio, industria elettronica, industria alimentare e prodotti farmaceutici. Bordo arrotolato colore naturale. Disponibili nelle versioni: con polvere finitura liscia, senza polvere finitura texturizzata. Spessore mm 0,10. Taglie (EN): S (6^{1/2},7) - M (7^{1/2},8) - L (8^{1/2},9) - XL (9^{1/2},10).

GEK69318 - dispenser da 100 pezzi senza polvere di mais, lunghezza mm 240

3 TOUCH N TUFF™ 92-600 III^A CATEGORIA



Guanti monouso in **nitrile**, robusti, senza polvere ne siliconi per ridurre il rischio di dermatiti. Ideali per la protezione dagli spruzzi chimici, altamente versatili e idonei anche per altri usi. Resistenti alla perforazione fino a quattro volte in più rispetto ai guanti comparabili di lattice naturale. Facile calzabilità e presa salda su oggetti asciutti o bagnati. Adatti per: trasferimenti di liquidi e solidi, prelievo ed elaborazione di campioni, trasformazione di alimenti, carne e pesce, analisi di laboratorio, produzioni industriali, manutenzione, manipolazione di sostanze chimiche. Spessore mm 0,14. Taglie (EN): S (6^{1/2},7) - M (7^{1/2},8) - L (8^{1/2},9) - XL (9^{1/2},10). Venduti in sacchetto dispenser da 100 pezzi.

GEK92600 - lunghezza mm 240



4



4 PROFOOD™ 87-305 III^A CATEGORIA



Guanti in **puro lattice naturale 100%** senza fodera, zigrinati e riutilizzabili. Clorinati all'esterno per ottimizzare le resistenze chimiche e meccaniche. Interno satinato senza felpatura trattato con bagno di clorurazione molto potente per minimizzare il rischio di allergie. Polso dentellato, ideali per mansioni leggere, buona destrezza. Approvati per l'industria alimentare. Industrie primarie: trasformazione alimentari, imprese di pulizia/igienizzazione, manutenzione, agricoltura. Adatti per: tutte le applicazioni e trasformazioni che prevedono il contatto con gli alimenti, manipolazione di sostanze chimiche, attività ortofrutticole, operazioni di pulizia. Colore blu. **Minimo ordinabile 12 paia/multipli**. Taglie (EN): 7 (7^{1/2},8) - 8 (8^{1/2},9) - 9 (9^{1/2},10) - 10 (10^{1/2},11).

GE87305/L - lunghezza mm 305, spessore mm 0,43



5



6



5 GREMBIULE ANTIACIDO, ANTIOLIO III^A CATEGORIA



Grembiule in **vinile** resistente a olii, grassi, prodotti chimici, abrasione e perforazione. Occhielli in PVC, lacci in nylon. **A norma EN14605:2005 - EN ISO 13688:2013**. Dimensioni cm 90 x 115.

GE045W - grembiule medio pesante colore bianco, peso gr 475

6 GREMBIULE PER INDUSTRIA CHIMICA III^A CATEGORIA



Grembiule per l'industria chimica in **PVC** ad elevata protezione da acidi e basi. È una valida barriera contro spruzzi accidentali. **A norma EN 14605:2005 - EN ISO 13688:2013**. Dimensioni cm 90 x 115.

GE045G - grembiule pesante colore verde, peso gr 644



PROTEZIONE DELLA CUTE, CREME MANI

Perchè è importante proteggere le mani?

La pelle costituisce una barriera tra l'essere umano e l'ambiente che lo circonda proteggendo il corpo dagli effetti dannosi, esponendosi in prima linea a queste influenze. Se la pelle non è sufficientemente protetta, possono verificarsi serie dermatiti. Un terzo di tutte le malattie professionali colpisce la pelle. Negli ultimi anni sono stati registrati oltre 25.000 casi di dermatite all'anno, ma gli esperti ritengono che il numero effettivo possa essere da 50 a 100 volte superiore.

L'IMPORTANZA DELLE CREME BARRIERA

Le creme barriera prevengono la penetrazione e l'assorbimento nella pelle di diversi liquidi e sostanze pericolose. Riducono il rischio di lesioni e altre reazioni derivate dall'esposizione o contatto con agenti tossici. La corretta protezione della nostra pelle comincia con una crema barriera per la difesa (Skin Protection), passa per una crema per una detersione benefica non aggressiva (Skin Cleaning) e si conclude con una crema curativa antinfiammatoria che accelera la guarigione di ferite da screpolature (Skin Care).



GUARDA IL VIDEO!

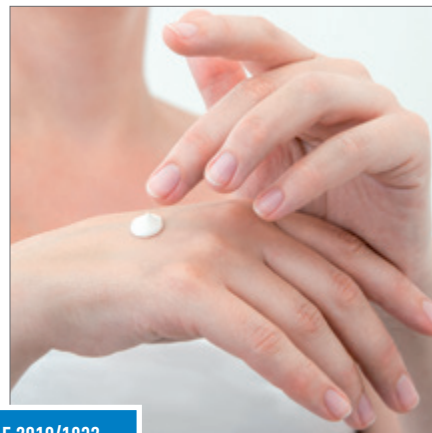

L'USO DI QUESTI PRODOTTI È RACCOMANDATO DALLA DIRETTIVA UE 2019/1832.

SKIN PROTECTION

Prima e durante il lavoro



Protezione contro lo sporco, oleorepellente



Protezione contro diverse sostanze, oleorepellente e idrorepellente



Protezione contro sostanze solubili in acqua, idrorepellente



1



2

OIL PROTECTOR REMO TEC

Crema barriera idrosolubile e oleorepellente, profumata, facilita la pulizia della pelle da diverse sostanze come oli, grassi, vernici, resine, polveri metalliche ecc. senza irritare. Crea un film idrosolubile sulla pelle che previene l'adesione di particelle di sporco. Grazie alla presenza di allantoina e glicerina idrata e protegge l'epidermide.

- 1 **CRG042** - tubetto crema barriera Oil Protector Remo Tec da 100 ml
- 2 **CRG043** - contenitore crema barriera Oil Protector Remo Tec da 2000 ml



3



4

UNIVERSAL PROTECTOR MULTI TEC

Crema barriera universale profumata. Ideale se si entra in contatto ripetutamente con differenti sostanze nocive/irritanti sia idrodissolte che oleodissolte, se sottoposti allo stress meccanico o per prevenire la macerazione dovuta all'uso di guanti. Protegge da oli e sostanze oleosolubili e dagli alcoli grassi resistenti all'acqua.

- 3 **CRG038** - tubetto crema barriera Universal Protector da 100 ml
- 4 **CRG039** - contenitore crema Universal Protector da 2000 ml per dispenser



5



5 IDROSOLUBIL PROTECTOR AQUA TEC

Crema barriera idrorepellente profumata contro le sostanze idrosolubili irritanti o aggressive come soluzioni acide o alcaline diluite, liquidi refrigeranti, detersivi e disinfettanti. Composta da vaselina e alcol grassi, crea un film invisibile sulla pelle e, grazie all'aggiunta di vitamina-A e olio di girasole, idrata e nutre l'epidermide.

- CRG084** - tubetto crema barriera Idrosolubil Protector da 100 ml



SKIN CLEANING

Durante e dopo il lavoro



Per lo sporco leggero



Per lo sporco di media - alta resistenza



Per lo sporco estremamente aggressivo e resistente



1



2



3



4



5



6

DETERGENTE MANI SOFT V

Detergente lavamani profumato per lo sporco leggero, ideale per gli uffici. La combinazione bilanciata di tensioattivi consente un'ottima tolleranza della pelle. Adatto al naturale valore pH della pelle, non contiene sapone. Bilanciamento lipidico, molto delicato sulla pelle.

- 1 **CRG093** - contenitore detergente Soft V lavamani da 500 ml
- 2 **CRG094** - contenitore detergente Soft V lavamani da 2000 ml per dispenser

DETERGENTE MANI SOFT G

Detergente lava mani per lo sporco medio-forte. Grazie al naturale effetto scrub della polvere di semi d'oliva rimuove in modo veloce ed efficace residui di grasso, olio, polvere di metallo, grafite e fuliggine. La presenza di sostanze naturali come l'olio di colza aiutano a prevenire le irritazioni senza alterare il naturale pH della pelle.

- 3 **CRG020** - contenitore detergente Soft G lavamani da 250 ml
- 4 **CRG021** - contenitore detergente Soft G lavamani da 2000 ml per dispenser

DETERGENTE MANI SOFT ULTRA

Detergente per sporco molto resistente e adesivo. Additivi ed estratti naturali come la polvere di semi d'oliva, garantiscono la massima efficacia contro lo sporco di vernici, resine, adesivi, pitture e bitume. Rispetta il naturale pH della pelle.

- 5 **CRG060** - tubetto detergente Soft Ultra lavamani da 250 ml
- 6 **CRG061** - contenitore detergente Soft Ultra lavamani da 2000 ml per dispenser

SKIN CARE

Dopo il lavoro



Per pelli normali e stessate



7



7 CREMA CURATIVA LOTION D

Crema profumata curativa adatta alla pelle delle mani e di tutto il corpo. Fornisce idratazione alla pelle stressata, donando una sensazione di freschezza. Asciuga rapidamente lasciando la pelle morbida e asciutta. Contiene pantenolo che ha una funzione antinfiammatorie ed accelera la guarigione di ferite da screpolatura.

- CRG004** - tubetto crema Lotion D idratante da 100 ml



8



8 DISTRIBUTORE VARIOMAT ECO

Realizzato in materiale plastico igienico, nessun contatto fra prodotto e dispenser. Modello Universale per contenitori da 2000 ml. Contiene un dispositivo di misurazione per ridurre la quantità erogata. Fornito completo di bulloneria per il fissaggio a muro.

- CRG090** - dispenser a muro vuoto, dimensioni (h x l x p) mm 351 x 126 x 130

PROTEZIONE DEI PIEDI: NORME E NOTE INFORMATIVE



NORMA UNI EN ISO 20344

Requisiti e metodi di prova per calzature di sicurezza calzature di protezione e calzature da lavoro per uso professionale.

NORMA UNI EN ISO 20345



Specifiche per calzature di sicurezza per uso professionale: calzature dotate di puntale 200 J.

SB = sicurezza base							
S1 = SB + E + A							
S1P = SB + E + A + P							
S2 = S1 + WRU							
S3 = S2 + P							

NORMA UNI EN ISO 20346



Specifiche per calzature di sicurezza per uso professionale: calzature dotate di puntale 100 J.

PB = sicurezza base							
P1 = PB + E + A							
P2 = P1 + WRU							
P3 = P2 + P							

NORMA UNI EN ISO 20347



Specifiche per calzature di sicurezza per uso professionale: calzature non dotate di speciali protezioni delle dita del piede.

OB = sicurezza base						
01 = OB + E + A						
02 = 01 + WRU						
03 = 02 + P						

NORMA EN 13287



Coefficiente di attrito. Roof Grip UNI 11583:2015
coefficiente d'attrito secondo la prova UNI EN ISO 13287.

SRA = soddisfa i requisiti della condizione con ceramica/soluzione detergente

SRB = soddisfa i requisiti della condizione con acciaio/glicerina

SRC = soddisfa entrambi i requisiti (SRA + SRB)

NORMA EN ISO 61340-4-3



ESD = Electro Static Discharge

Le calzature ESD servono a dissipare a terra la tensione elettrostatica accumulata nel corpo umano. Il grado di antistaticità di una calzatura viene definito attraverso la resistenza elettrica (Ω Ohm). La carica elettrica si può formare per sfregamento e separazione tra due corpi differenti quali: calpestio su pavimenti sintetici, sfregamento di indumenti sintetici, spostamento di contenitori di plastica, ecc.

INTERPRETAZIONE DEI REQUISITI

P	Resistenza della suola alla perforazione
E	Assorbimento di energia nella zona del tallone
A	Calzatura antistatica
C	Calzatura conduttiva
I	Calzatura elettricamente isolante
WRU	Tomaia idrorepellente
CI	Fondo isolante contro il freddo
HI	Fondo isolante contro il calore
HRO	Resistenza della suola al calore per contatto
FO	Resistenza della suola agli oli e idrocarburi
WR	Calzatura resistente all'acqua
M	Protezione metatarsale
AN	Protezione della caviglia
CR	Resistenza al taglio del tomaia
SRC	Suola antiscivolo





2



4



5

6

GLOVE II E GLOVE II H



Suola in gomma nitrilica. **Puntale in alluminio, lamina non metallica a passaggio 0, calzata 10.** A norma EN ISO 20345.

1 ZCS17023.. - scarpa bassa, tomaia colore nero in **Nabuck idrorepellente**, esecuzione S3 SRA HRO. Misure: 35/48

2 ZCS17068.. - scarpa bassa, tomaia colore nero in **vitello scamosciato**, esecuzione S1P SRA HRO. Misure: 38/48

2 ZCS17027.. - scarpa alta, tomaia colore nero in **Nabuck idrorepellente**, esecuzione S3 SRA HRO. Misure: 35/48

GLOVE MDS LOW



Tomaia in Nubuck silk idrorepellente. Mass Damper Technology, **Puntale in alluminio 200 J, calzata 11.** Fodera Air Mesh, plantare estraibile in PU. Protezione del tallone in TPU. Esecuzione S1P SRC HRO. A norma EN ISO 20345. Misure: 36/46.

3 ZCS75029.. - scarpa bassa color sabbia

4 ZCS80013.. - scarpa bassa colore nero

GLOVE NET PRO



Tomaia in pelle antigraffio, idrorepellente e traspirante. Suola in gomma nitrilica, protezione punta. **Puntale in alluminio, lamina non metallica, calzata 11.** Esecuzione S3 SRA HRO ESD. A norma EN ISO 20345. Misure: 35/48.

5 ZCS3527.. - scarpa alta colore nero

6 ZCS3528.. - scarpa bassa colore nero



8



10

11



12

13

GLOVE NET LOW



Tomaia in pelle Perwanger antigraffio, idrorepellente e traspirante. Suola in gomma nitrilica HRO. **Puntale in alluminio, lamina non metallica, calzata 11.** Esecuzione S1P SRA HRO ESD. A norma EN ISO 20345. Misure: 35/48.

7 ZCS3529.. - scarpa bassa colore blu

8 ZCS3530.. - scarpa bassa colore grigio

SHARK STABLE IMPACT



Tomaia in tessuto tecnico poliestere 350 gr/m². **Puntale in alluminio, calzata 11.** Fodera Air Mesh con antifiscante, K-SOLE, plantare estraibile. Esecuzione S3 SRC ESD. A norma EN ISO 20345. Misure: 36/46.

9 ZCS1153.. - scarpa bassa color sabbia

10 ZCS2541.. - scarpa bassa colore nero

11 ZCS7669.. - scarpa alta colore nero

RUN MID E RUN LOW



Tomaia in Nabuck Pull Up idrorepellente, traspirante, antistatica, plantare estraibile. Intersuola in PU espanso, suola in PU. **Puntale in acciaio, calzata 10.** esecuzione S3-SRC-ESD. A norma EN ISO 20345. Misure: 35/49.

12 ZCS5304.. - scarpa alta Run II

13 ZCS5303.. - scarpa bassa Run II



14

15



16

17



18

19

RUN NET AIRBOX



Tomaia in crosta scamosciata idrorepellente (S3) e tomaia in crosta scamosciata e mesh (S1P). Suola antiperforazione K SOLE, fodera in Nylon antiabrasione e ultra traspirante, plantare estraibile. **Puntale in alluminio 200 J, calzata 11.** A norma EN ISO 20345. Misure: 35/48.

14 ZCS76223.. - scarpa alta mid-cut, colore nero, esecuzione S3 SRC

15 ZCS76220.. - scarpa bassa, colore nero, esecuzione S3 SRC

16 ZCS76221.. - scarpa bassa, colore grigio, esecuzione S3 SRC

17 ZCS76222.. - scarpa bassa, colore blu, esecuzione S3 SRC

RUN TEXT LOW



Tomaia in crosta e tessuto rete, traspirante, antistatica, plantare estraibile. Intersuola in PU espanso con tecnologia D-Light. Suola in PU compatto antiabrasione. **Puntale in acciaio, calzata 10.** Esecuzione S1P SRC ESD. A norma EN ISO 20345. Misure: 35/49.

18 ZCS5305.. - scarpa bassa colore grigio/blu

19 ZCS5306.. - scarpa bassa colore grigio



1

NEW

1 HARD

Tomaia idrorepellente in Putek® Plus resistente all'abrasione. **Puntale AirToe® in alluminio**, soffietto in nylon imbottito. **Suola con sistema Infinergy®, intersuola in PU espanso**. Misure 38/48.

ZCP10356.. - scarpa alta Hard, esecuzione S3 SRC CI ESD. A norma EN ISO 20345



2

2 KICK

Tomaia in morbida pelle nabuk naturale idrorepellente, soffietto in nylon imbottito. Suola defaticante in PU, **puntale in alluminio forato con membrana resistente a 200J, lamina antiperforazione non metallica**. Misure 35/48.

ZCP20023.. - scarpa bassa Kick, esecuzione S3 SRC. A norma EN ISO 20345



3

3 INFINITY

Tomaia in morbida pelle nabuk naturale idrorepellente, collarino "No stress" per miglior comfort. Suola defaticante in PU, **puntale in alluminio forato con membrana resistente a 200J, lamina antiperforazione non metallica**. Misure 35/48.

ZCP10023.. - scarpa alta Infinity, esecuzione S3 SRC. A norma EN ISO 20345



4

NEW

4 MICHELLE

Tomaia in nylon ultra-traspirante con **bande laterali a contrasto rosa**. Sottopiede leggero e traspirante, **puntale AirToe® in alluminio leggero (54 gr)** con film anti-abrasione a protezione della punta. Misure 35/42.

ZCP20086.. - scarpa bassa Michelle, esecuzione S1P SRC ESD. A norma EN ISO 20345



5

5 POINT

Tomaia in morbida pelle scamosciata, inserti reflex traspiranti, soffietto in nylon imbottito. Suola defaticante in PU, **puntale in alluminio forato con membrana resistente a 200J, lamina antiperforazione non metallica**. Misure 35/48.

ZCP20037.. - scarpa bassa Point, esecuzione S1P SRC. A norma EN ISO 20345



6

6 ACTIVE

Tomaia in morbida pelle scamosciata, inserti reflex traspiranti, soffietto in nylon imbottito. Suola defaticante in PU, **puntale in alluminio forato con membrana resistente a 200J, lamina antiperforazione non metallica**. Misure 35/48.

ZCP20066.. - scarpa bassa Active, esecuzione S1P SRC. A norma EN ISO 20345



7

NEW

7 STRONG

Tomaia in Putek® Plus resistente all'abrasione. Puntale AirToe® in alluminio. Suola con sistema Infinergy®, intersuola in PU. Misure: 36/46.

ZCP20356.. - scarpa bassa Strong, esecuzione S3 SRC CI ESD. A norma EN ISO 20345



8

8 TROPHY

Tomaia in Canvas extra strong traspirante, inserti in pelle scamosciata. Suola in PU, **puntale in alluminio e lamina non metallica**. Misure: 35/48.

ZCP20056.. - scarpa bassa Trophy, esecuzione S1P SRC. A norma EN ISO 20345



9

9 NICO

Tomaia in pelle scamosciata con inserti in MESH ultra traspirante. Suola in PU, **puntale in alluminio e lamina non metallica**. Misure 35/48.

ZCP20136.. - scarpa bassa Nico, esecuzione S1P SRC. A norma EN ISO 20345



10

NEW

10 SUMMER CARPET

Tomaia in Ainet® ultra traspirante e morbida pelle scamosciata. **Puntale AirToe® in alluminio** e sistema antiperforazione. Intersuola in PU espanso. Misure 36/46.

ZCP20346.. - scarpa bassa Summer Carpet, esecuzione S1P SRC ESD. A norma EN ISO 20345



11

NEW

11 BRYAN

Tomaia in Putek® Star altamente resistente all'abrasione, puntalino in PU e tallonetta anti-shock, puntale in alluminio, antiperforazione, antiscivolo. Misure 38/48.

ZCP20114.. - scarpa bassa Bryan, esecuzione S3 SRC CI ESD. A norma EN ISO 20345



12

12 EMOTION

Tomaia in morbida pelle scamosciata, con soffietto in nylon imbottito. Suola in PU, **puntale in alluminio forato con membrana resistente a 200J**, lamina antiperforazione non metallica. Misure 35/48.

ZCP20087.. - scarpa bassa Emotion, esecuzione S1P SRC. A norma EN ISO 20345



1

1 BURGAZ



Scarpa bassa, in tessuto tecnico traspirante e resistente all'abrasione e MICRO-tech. Fodera in tessuto altamente traspirante e resistente all'abrasione. **Puntale e lamina in composito.** Calzatura interamente senza parti metalliche. Suola in poliuretano tre densità antistatica, resistente all'idrolisi ISO 5423:92, agli idrocarburi e all'abrasione, antishock e antiscivolo. Misure 39-47. Esecuzione S1P SRC. A norma EN 20345. CE UNI EN ISO 20345:2012 S1P SRC.

ZC9318A.. - scarpa bassa Burgaz



2

ALLACCIATURA FACILITATA CON RONDELLA

2 GOTLAND



Scarpa bassa, in pelle grouponne antigraffio WRU spessore 1,8-2,0 mm. e tessuto tecnico traspirante e resistente all'abrasione. Sistema di **allacciatura con rondella** che facilita la chiusura/apertura anche con i guanti. Fodera in tessuto altamente traspirante e resistente all'abrasione, inserto rifrangente. **Puntale e lamina in composito.** Suola in poliuretano a tre densità resistente all'idrolisi ISO 5423:92, agli idrocarburi e all'abrasione, antishock e antiscivolo. Misure 39/47. Esecuzione S1P SRC. A norma EN ISO 20345.

ZC9322A.. - scarpa bassa Gotland



3

3 ARUBA



Scarpa bassa, in tessuto tecnico traspirante e resistente all'abrasione e in pelle grouponne antigraffio. Fodera in tessuto altamente traspirante e resistente all'abrasione, inserto rifrangente. **Puntale e lamina in composito.** Calzatura interamente senza parti metalliche. Suola in poliuretano tre densità antistatica, resistente all'idrolisi ISO 5423:92, agli idrocarburi e all'abrasione, antishock e antiscivolo. La calzatura soddisfa il requisito in accordo con IEC 61340-4-3:2017 (IEC 61340-5-1:2016) per la resistenza elettrica ESD Misure 36/47. Esecuzione S3 SRC ESD. A norma EN 20345.

ZC9192A.. - scarpa bassa ARUBA

ALTRI MODELLI GIASCO FORNIBILI A RICHIESTA.



4

4 SPORT



In pelle fiore Nabuk idrorepellente con inserto in tessuto rifrangente. **Senza parti metalliche.** Suola ERGO SAFE in PU bidensità antistatica, resistente all'idrolisi (ISO 5423:92), agli idrocarburi e all'abrasione, antishock e antiscivolo. **Puntale e lamina in composito.** Sottopiede bi-componente estraibile: tallonetta anatomica ed antishock. Misure: 36/47. A norma EN ISO 20345.

ZC7325A.. - scarpa bassa, esecuzione S3 SRC + WRU ESD



5

RUGBY - BASKET



In vera pelle fiore Nubuck idrorepellente (WRU). Suola in PU bidensità antistatica, resistente all'idrolisi, agli idrocarburi e all'abrasione, anti-shock e antiscivolo. Interamente senza parti metalliche, **puntale e lamina in composito.** Misure: 38/47. Esecuzione S3.

5 ZC8370A.. - scarpa alta Basket. A norma EN ISO 20345, **EN 13287** e certificata UNI 11583:2015 (norma specifica per calzature professionali per lavoro su tetti inclinati)

6 ZC8371A.. - scarpa bassa Rugby. A norma EN ISO 20345



6



7



7 FRANKLIN



In pelle grouponne scamosciato, con tallone in pelle fiore Nubuck impermeabile (WRU), fodera esterna in tessuto Cordura® resistente all'abrasione; fodera interna in tessuto traspirante antibatterico ed idrofila. Suola in PU bidensità antistatica, resistente all'idrolisi, agli idrocarburi e all'abrasione, anti-shock e antiscivolo. Interamente senza parti metalliche, **puntale e lamina in composito.** Isolamento elettrico fino a 1000 V (suola dielettrica). Resistenza della suola al calore per contatto (HRO). Misure: 38/47. Esecuzione SB E P WRU HRO. A norma EN ISO 20345.

ZC2022A.. - scarpa bassa Franklin



8

8 USTICA



Scarpa bassa in MICROWASH. Fodera in tessuto altamente traspirante e resistente all'abrasione. **Puntale in composito.** Calzatura interamente senza parti metalliche. Suola in poliuretano a tre densità antistatica, resistente all'idrolisi ISO 5423:92, agli idrocarburi e all'abrasione, antishock e antiscivolo. La calzatura soddisfa il requisito in accordo con IEC 61340-4-3:2017 (IEC 61340-5-1:2016) per la resistenza elettrica ESD. Misure 36/47. Esecuzione S2 SRC ESD. A norma EN 20345.

ZC9321A.. - scarpa bassa Ustica



9

9 FREE



Sabot in MICROWASH con fodera traspirante e resistente all'abrasione. **Puntale in composito.** Suola in poliuretano bidensità antistatica, resistente all'idrolisi (ISO 5423:92), agli idrocarburi e all'abrasione, antishock e antiscivolo SRC. Soletta 5000 trimaterial extracomfort, anatomica, ESD e antibatterica. La calzatura soddisfa il requisito in accordo con IEC 61340-4-3:2001 per la resistenza elettrica **ESD classe 3 (calzatura dissipativa elettrica)**. Cinturino girevole. Misure 36/47. Esecuzione SB + FO + A + E + SRC + ESD CLASS 3.

ZC90070.. - zoccolo esecuzione SB FO A E SRC ESD



10



11

SOLETTE









10 ZC903.. - soletta trimaterial extra comfort con morbido cuscinetto in gel defaticante nel tallone. Resistente alla pressione corporea. Traspirante, anatomica, assorbente, ESD ed antibatterica. Misure: 36/47

11 ZC904.. - soletta trimaterial extra comfort con cuscinetto in morbido lattice Memory defaticante nel tallone e resistente alla pressione corporea. Traspirante, estraibile, anatomica, assorbente, antibatterica ed antistatica. Misure 36/47.



LEGENDA

-  Suola di protezione
-  Puntale di protezione
-  Assorbimento dell'impatto al suolo
-  Supporto naturale della curvatura del piede
-  Climate System
-  Protezione contro il taglio
-  Sistema di allacciatura flessibile

i PARTI DI RICAMBIO QUALI SOTTOPIEDI, LACCI, ZIP ECC. DISPONIBILI SU RICHIESTA. MISURE EXTRA-GRANDI 48-51 DISPONIBILI SU RICHIESTA.



1 AIRPOWER® XR1



Soccorso/lavoro. In pelle fiore spessore 2,0 - 2,2 mm, fodera Crosstech® traspirante e impermeabile. Antistatici, suola Airpower® XR in PU/gomma con grip incrementato. Puntale e lamina in composito. Copri puntale antiusura. Zip di chiusura sostituibile. A norma EN ISO 20345. Misure 35 - 47.

ZCH5117.. - stivaletto altezza 19 cm, esecuzione S3 WR HRO HI CI SRC



2 AIRPOWER® XR26



Lavoro. Pelle spessore 2,0 - 2,2 mm, fodera impermeabile e traspirante Gore-Tex®. Puntale composito e antiforo acciaio, antistatici. Robusta suola PU/gomma antiscivolo. A norma EN ISO 20345. Misure 39-47.

ZCH7205.. - scarpa nabuk marrone, alta 13,5, esecuzione S3 HRO HI CI WR SRC



3 BLACK EAGLE® SAFETY 40.1 MID E LOW



Lavoro Indoor/Outdoor. Tomaio in tessuto tecnico poliammide/microfibra, impermeabili e traspiranti, fodera Gore-Tex® Pearl. Metal-free e ESD. Puntale in composito e antiforo tessile. Suola PU/gomma antiscivolo. A norma EN ISO 20345. Misure 35-47.

- 3 ZCH6115..** - scarpa alta 13 cm, esecuzione S3 HRO HI CI WR SRC
- 4 ZCH1017..** - scarpa alta 13 cm, esecuzione S3 HRO HI CI WR SRC
- 5 ZCH1003..** - scarpa bassa 7,5 cm, esecuzione S1P HRO HI CI SRC
- 6 ZCH6101..** - scarpa bassa 7,5 cm, esecuzione S3 HRO HI CI WR SRC



6 BLACK EAGLE® SAFETY 53 LOW E MID



Lavoro Indoor/Outdoor. Pelle nabuk spessore 2,0 - 2,2 mm con fodera impermeabile e traspirante Gore-Tex® Extended. Metal-free e ESD. Puntale in composito, copri puntale in TPU, antiforo tessile. Suola PU/gomma antiscivolo, resistente all'abrasione, al calore di oli e benzine, eccellente isolamento termico. Haix® Climate System. Ottima calzatura e comfort, sostegno anatomico del piede per l'intera lunghezza. A norma EN ISO 20345. Misure 35-47.

- 7 ZCH6107..** - scarpa bassa 8 cm, esecuzione S3 HRO HI CI WR SRC
- 8 ZCH6122..** - scarpa alta 14,5 cm, esecuzione S3 HRO HI CI WR SRC



9 BLACK EAGLE® SAFETY 50 HIGH



Lavoro. Flessibile e leggera, in pelle fiore con fodera impermeabile e traspirante Gore-Tex®. Metal-free e ESD. Puntale in composito e anti-perforazione tessile. Suola PU/gomma con stabilizer integrato, fondo altamente antiscivolo. Allacciatura regolabile a 2 zone. A norma EN ISO 20345. Misure 35-47.

ZCH6210.. - scarpa alta, gambale 20 cm, esecuzione S3 WR HRO HI CI SRC ESD



10 PROTECTOR LIGHT 2.1



Forestale/lavoro. Pelle nabuk oleata spessore 2,2 - 2,4 mm, fodera in pelle, protezione taglio motosega Livello 2, antistatici. Protezione dai tagli in Kevlar® certificata livello taglio 2 (24 m/sec). Puntale in composito ed anti-perforazione tessile. Suola PU/gomma, alta resistenza all'abrasione, antiscivolo. Sistema di allacciatura rapida, protezione del tendine integrata, tomaio privo di cuciture laterali, area della punta rinforzata e copri puntale in TPU. A norma EN ISO 20345 - EN ISO 17249:2013 + AC:2014. Misure 36-47.

ZCH4111.. - scarpa alta 17 cm, esecuzione S3 HRO HI CI WR SRC + antitaglio livello 2

11 SOLETTE PERFECTFIT

100% poliestere. Funzionali, sicure, traspiranti, confortevoli, Aumentano stabilità e controllo, riducono lo scivolamento. Misure 35 - 47.

ZCH1454W.. - soletta gialla, sottile 4 mm

ZCH1454M.. - soletta rossa, media 6 mm (ricambio alla standard)

ZCH1454N.. - soletta blu, alta 8 mm



1 STIVALE DIELETTICO

Con isolamento elettrico: protezione fino a 20kV sull'intero stivale per 8 ore e 35 kV sulla suola per 3 minuti. Puntaletto in acciaio, rivestimento in maglia di nylon, soletta interna estraibile e lavabile. Suola in gomma vulcanizzata resistente a olio e combustibile, resistenza al contatto caldo 60 secondi a 300°C. Conforme a REACH e alle norme: EN ISO 20345 SB E CI HRO SRC FO - EN 50321 Classe 0 - ASTM F1117 (calzature dielettriche). Misure: 39/46 (escluso 40).
ZCR95.. - stivale dielettrico giallo

2 STIVALE A PROTEZIONE CHIMICA

Antistatico, puntaletto integrato, protezione da vapori chimici. Puntaletto in acciaio, rivestimento in maglia di nylon, soletta interna estraibile. Suola in gomma vulcanizzata resistente a olio e combustibile, resistenza al contatto caldo 60 sec. a 300°C. Conforme a REACH e alle norme: EN 13832 pt. 3 - EN ISO 20345 S5 HRO SRA CI. Misure: 39/46 (escluso 40).
ZCR84.. - stivale protezione chimica colore verde

3 STIVALE AL GINOCCHIO

Stivale al ginocchio in PVC. Fodera in jersey, suola a carrarmato in PVC. Puntaletto e lamina in acciaio. A norma EN ISO 20345. Misure: 38/47.
ZC6425Y.. - stivale in PVC colore giallo, esecuzione S5 SRC
ZC6425.. - stivale in PVC colore verde, esecuzione S5 SRC
ZC6425B.. - stivale in PVC colore blu, esecuzione S5 SRC

4 TRONCHETTO PVC

In PVC per rischi minimi. Suola a carrarmato. Misure: 39/46.
ZC6301.. - stivale tronchetto

5 TRONCHETTO PVC IMBOTTITO

Stivale in PVC colore verde. Fodera in poliestere, imbottito con pelliccia sintetica, suola a carrarmato in PVC. A norma EN ISO 20347 OB E CI SRC. Misure: 39/47.
ZC6320.. - stivale imbottito



ALTRI STIVALI DIELETTRICI A PAGINA 427.



STIVALI PER VIGILI DEL FUOCO A PAGINA 467.



6 STIVALE IN PVC NITRILICO

Stivale da lavoro in gomma nitrilica (PVC nitrilico) con puntaletto in acciaio, suola carrarmato, taglio ergonomico e tre tipi di rifinitura per una migliore pulitura. Inserto sul tallone per facilitare la svestizione. A norma: EN ISO 20345 S4 SRC. Misure: 36/47.
ZC6426.. - stivale in gomma nitrilica colore bianco

7 STIVALI AL GINOCCHIO

Stivale al ginocchio in PVC a norma EN ISO 20347. Due colori. Misure: 36/46.
7 ZC6310.. - stivale al ginocchio in PVC colore verde
8 ZC6310N.. - stivale al ginocchio in PVC colore nero

9 STIVALI DA BOSCAIOLO

In gomma con puntaletto e lamina. Protezione da taglio con motosega su tibia e metatarso in gomma multistrato. Suola anti derapante. A norma EN ISO 17249+A1 EN ISO 20345 (P classe 3) SRA. Misure: 40/47.
ZCI8907. - stivali da boscaiolo verde arancio



10 STIVALE SCAFIANDRO IN PVC

In PVC nitrilico con fodera in nylon, puntaletto e lamina in acciaio. Suola carrarmato in PVC nitrilico. A norma: EN ISO 20345 S5 SRC. Misure: 38/47.
ZC6361.. - stivale scafiandro

11 STIVALE TUTTACOSCIA IN PVC

In PVC nitrilico con fodera in nylon, puntaletto e lamina in acciaio. Suola carrarmato in PVC nitrilico. A norma: EN ISO 20345 S5 SRC. Misure: 38/47.
ZC6351.. - stivale tuttacoscia

ANTICADUTA: INFORMAZIONI TECNICHE



TECNICHE DI LAVORO IN ALTEZZA

Nei lavori in altezza è possibile scegliere tra una o più delle seguenti tecniche, in base all'entità del rischio, alle caratteristiche della struttura ed alla tipologia del lavoro da svolgere.

TRATTENUTA: tecnica che serve ad impedire all'operatore di raggiungere una zona a rischio di caduta, attraverso la limitazione della lunghezza della connessione tra punto di ancoraggio e imbracatura dell'operatore.

POSIZIONAMENTO: tecnica che serve a mantenere l'operatore in tensione con i dispositivi, eliminando la possibilità di caduta. Normalmente la connessione è regolabile in lunghezza. Da valutare attentamente la possibilità di prevedere una seconda connessione di sicurezza anticaduta.

ANTICADUTA: tecnica che permette l'arresto di una caduta dall'alto e la riduzione della forza sviluppata durante la caduta. Il sistema comprende un'imbracatura completa anticaduta ed una connessione che incorpori una funzione di assorbimento di energia.

ACCESSO SU CORDA: sistemi che permettono all'utilizzatore di accedere alla zona di lavoro in tensione o in sospensione, in modo che la caduta libera sia prevenuta o arrestata. Prevedono sempre una corda di lavoro per la movimentazione tramite discensori e risalitori, abbinata ad una corda di sicurezza dotata di un dispositivo anticaduta, che interviene in caso di problemi sulla corda di lavoro.

SOCCORSO: sistema che permette di evacuare dalla zona di lavoro se stessi o altri. Deve garantire la protezione sia dell'infortunato che del soccorritore e deve permettere l'evacuazione in luogo sicuro tramite una discesa e/o una risalita. Può comprendere una sola linea di soccorso: la linea di sicurezza aggiuntiva deve essere prevista necessariamente durante la formazione. Un sistema di soccorso e la relativa procedura devono sempre essere previsti per tutte le tipologie di lavoro in altezza.

ANTICADUTA

Durante l'utilizzo di sistemi anticaduta sono necessarie alcune precauzioni:

- I cordini con assorbitore di energia non devono superare la lunghezza di 2 metri (moschettoni compresi): per lo Shock Absorber Limited la lunghezza massima è di 1,5 m.
- È necessario ridurre al minimo l'altezza possibile di caduta.
- Quando possibile cercare di limitare al massimo il fattore di caduta, evitando sempre che sia superiore a 2.
- Calcolare esattamente il tirante d'aria al di sotto del punto di ancoraggio necessario a far sì che l'operatore non raggiunga il suolo dopo la caduta (figura 2).

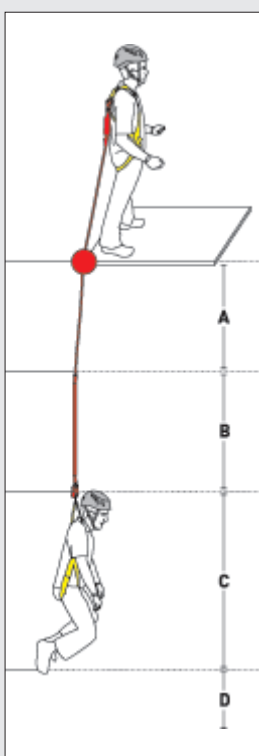

TIRANTE D'ARIA

- A** Lunghezza del cordino +
 - B** Estensione dell'assorbitore di energia +
 - C** Distanza fra l'attacco dell'imbracatura e i piedi dell'operatore, 1,5 m +
 - D** Altezza di sicurezza, 1 m.
- Con le tabelle in basso è possibile calcolare il tirante d'aria minimo per ogni situazione.
 - Dotarsi di adeguate attrezzature di soccorso e formare le squadre di lavoro in modo che possano soccorrere rapidamente l'infortunato per minimizzare gli effetti della sospensione inerte.



LA LUNGHEZZA DEL TIRANTE D'ARIA MINIMO VIENE CALCOLATA DAL PUNTO DI ANCORAGGIO.

FATTORE DI CADUTA

Per valutare la pericolosità di una situazione di lavoro, e quindi i DPI da utilizzare, viene definito il fattore di caduta (figura 1), calcolato con la seguente formula:

$$\text{FATTORE DI CADUTA} = \frac{\text{ALTEZZA DI CADUTA}}{\text{LUNGHEZZA DEL CORDINO}}$$

Nel caso in cui il fattore di caduta sia 0 e quindi l'operatore si trovi al di sotto del punto di ancoraggio con il cordino teso, oppure nel caso di fattore di caduta 1 ma con una libertà di movimento massima di 0,6 m, è possibile utilizzare cordini per il posizionamento (es. EN354 - EN358). Negli altri casi con fattore di caduta uguale o maggiore di 1 è obbligatorio l'utilizzo di dispositivi anticaduta (es. EN355) con dispositivo di assorbimento di energia.

	FATTORE 0	FATTORE 1	FATTORE 2
EN355 	✓	✓	✓
EN354 - EN358 	✓	!	✗

CONTATTACI PER INFORMAZIONI RELATIVE AGLI UTILIZZATORI CON PESO SUPERIORE A 100 KG.

ASSORBITORE DI ENERGIA NORMALE

LUNGHEZZA DEL CORDINO	FATTORE DI CADUTA		
	0	1	2
2 metri	4,5 metri	5,4 metri	6,1 metri
1,5 metri	4 metri	4,9 metri	5,6 metri
1 metro	3,5 metri	4,4 metri	5,1 metri

ASSORBITORE DI ENERGIA RETEXO

LUNGHEZZA DEL CORDINO	FATTORE DI CADUTA		
	0	1	2
1,5 metri	4 metri	4,5 metri	4,7 metri
1,35 metri	3,85 metri	4,35 metri	4,55 metri
1 metro	3,5 metri	4 metri	4,2 metri



! LE INFORMAZIONI TECNICHE IN MERITO ALLE VARIE ATTIVITÀ DI LAVORO IN ALTEZZA SONO PURAMENTE ESEMPLIFICATIVE E DEVONO ESSERE INTEGRATE E RIELABORATE IN FASE DI VALUTAZIONE DEI RISCHI PRIMA DELL'INIZIO DI QUALSIASI ATTIVITÀ, TENENDO CONTO DELLA LEGISLAZIONE SPECIFICA DI OGNI SINGOLO PAESE. LE TECNICHE EVIDENZIATE NON HANNO ALCUN VALORE FORMATIVO: L'UTILIZZO DI QUESTE TECNICHE E DEI RELATIVI DPI DEVE ESSERE PRECEDUTO DA FORMAZIONE ED ADDESTRAMENTO SPECIFICI.



1 BASIC  

Imbracatura con 1 attacco posteriore, fettuccia 44 mm in poliestere. Componenti in acciaio zincato. Abbinabile alla cintura di posizionamento (cod. ANC1268). A norma EN361. Peso 650 g.
ANC1298 - imbracatura Basic, taglia unica regolabile

2 BASIC DUO  

Imbracatura con 2 attacchi (posteriore e anteriore tramite anello a D da ordinare separatamente), fettuccia 44 mm in poliestere. Cosciali regolabili e sganciabili, cinta pelvica regolabile. Componenti in acciaio zincato. Abbinabile alla cintura di posizionamento (cod. ANC1268). A norma EN361. Peso 650 g.
ANC1275 - imbracatura Basic Duo, taglia unica regolabile

3 GRAVITY  

Imbracatura **veloce da indossare grazie alle fibbie a sgancio "STS" brevettate**. Imbottita, con 2 attacchi: sternale a doppia asola tessile e anello in lega d'alluminio dorsale. Due asole tessili laterali. A norma EN358 - EN361. Peso 1,81 kg.
ANC1265 - imbracatura Gravity, taglie disponibili: M (S, L) L (L, XXL)

4 ORBITAL  

Imbracatura leggera e confortevole, con 4 attacchi asole tessili: 1 sternale, 1 dorsale, 2 laterali di posizionamento. Cinturone di posizionamento incluso. Cosciali regolabili imbottiti, imbottitura aggiuntiva sulla schiena, fettuccia 44 mm in poliestere e cosciali imbottiti da 25 mm. A norma EN358 - EN361. Peso 1,35 kg.
ANC2120 - imbracatura Orbital, taglie disponibili: M (S, L) L (L, XL)



5 FOCUS VEST ANSI  

Imbracatura con 2 attacchi (sternale e dorsale), 2 anelli portaattrezzi. L'imbottitura da sostegno e protezione al schiena e spalle. Fibbie automatiche in acciaio zincato brevettate ANSI STS. 2 tasche frontali staccabili con chiusura a zip. Abbinabile alla cintura di posizionamento (cod. ANC1268). A norma EN361 - ANSI Z359.11. Peso 1,85 kg.
ANC2664 - imbracatura Focus Vest Ansi, taglia unica regolabile

6 VERTICAL 2 PLUS  

Imbracatura con cintura di posizionamento imbottita integrata. 5 attacchi: 1 posteriore, 2 anteriori e 2 laterali per il posizionamento. Fettuccia 44 mm in poliestere con cuciture ad alta resistenza. Cosciali regolabili e sganciabili, componenti in acciaio zincato. A norma EN358 - EN361. Peso 1,6 kg.
ANC0106 - imbracatura Vertical 2 Plus, taglia unica regolabile

7 VERTICAL 2  

Imbracatura con 3 attacchi: 1 posteriore, 2 anteriori. Fettuccia 44 mm in poliestere con cuciture ad alta resistenza. Cosciali regolabili e sganciabili, cinta pelvica regolabile. Componenti in acciaio zincato. Abbinabile alla cintura di posizionamento (cod. ANC1268). A norma EN361. Peso 1,2 kg.
ANC124702 - imbracatura Vertical 2, taglia unica regolabile

TUTTE LE IMBRACATURE CAMP SONO CERTIFICATE FINO A 150 KG!





ANTICADUTA RETRATTILI COBRA

Carter in ABS, cavo in acciaio zincato Ø 4,8 mm in diverse lunghezze: si estende e retrae automaticamente seguendo i movimenti dell'utilizzatore. Certificato per uso verticale (standard EN360) e per uso orizzontale/inclinato su spigoli vivi grazie all'assorbitore di energia esterno (utilizzato in abbinamento al cordino ANC5030101 fornito separatamente) in conformità al test europeo 11.060 Tipo A. Fornito con cordino guida Ø 5 mm, utile per guidare il cavo all'interno del dispositivo retrattile. Connettore girevole a doppia leva resistenza >23kN. A norma EN 360.

- 1 ANC3137** - anticaduta Cobra, dimensioni carter: Ø 18 x h 10 cm, peso kg 4,8, cavo 10 mt
- 2 ANC3138** - anticaduta Cobra, dimensioni carter: Ø 22 x h 11 cm, peso kg 7, cavo 15 mt
- 3 ANC3139** - anticaduta Cobra, dimensioni carter: Ø 25 x h 12 cm, peso kg 9, cavo 20 mt
- 4 ANC3140** - anticaduta Cobra, dimensioni carter: Ø 30 x h 13 cm, peso kg 12,5, cavo 30 mt

Connettori e moschettoni



8 CONNETTORE IN ACCIAIO

Per aggancio a strutture, bloccaggio con leva posteriore di sicurezza, apertura mm 53, lunghezza 220 mm. Peso 470 gr. A norma EN362.

ANC2017 - connettore in acciaio



9 CONNETTORE IN ACCIAIO

Per aggancio cordini e anticaduta a imbracatura, chiusura standard, bloccaggio ghiera a vite, apertura mm 16, lunghezza 108 mm. Peso 165 gr. A norma EN362.

ANC0981 - connettore in acciaio



5 DISPOSITIVO RETRATTILE COBRA 6

Dispositivo anticaduta per uso verticale con dissipatore di energia. Ingombro e peso limitati rispetto ai modelli in cavo metallico grazie all'utilizzo della fettuccia in poliestere. Carter in ABS. A norma EN 360.

ANC2075 - lunghezza fettuccia 6 m, peso 1,85 kg

6 DISPOSITIVO RETRATTILE COBRA 2

Carter in ABS, certificato per utilizzo verticale e per situazioni di lavoro con fattore di caduta 2 (in conformità con i requisiti dinamici EN 355). Lunghezza estesa 165 cm senza connettori (lunghezza massima con connettori 2 m). Fettuccia in poliestere da 46 mm. Carico di rottura >15 kN. Con assorbitore di energia, dispositivo di connessione girevole, connettore ovale. Peso kg 1,25. A norma EN 360.

ANC2074 - lunghezza fettuccia 1,8 mt compresi 2 connettori

7 FETTUCCIA DI PROLUNGAMENTO

Fettuccia tubolare di prolungamento in poliamide da 27 mm con chiusura a velcro per il fissaggio allo spallaccio delle imbracature anticaduta, utilizzabile come dispositivo di prolungamento. Carico di rottura kN 22. Peso 155 gr. A norma EN354, EN795/B.

ANC2030031 - fettuccia di prolungamento, lunghezza cm 30



10 CONNETTORE AGGANCIO A PUNTI DI ATTACCO STERNALE

Per imbracature con fettucce sternali da congiungere. Chiusura senza possibilità di impiglio della fune bloccaggio con ghiera a vite. **Apertura 24 mm, lunghezza 113 mm.** A norma EN362 - EN12275.

ANC1176 - connettore in alluminio, peso 75 gr



11 CONNETTORE AGGANCIO A PUNTI DI ATTACCO STERNALE

Per imbracature con fettucce sternali da congiungere. Bloccaggio con ghiera a vite. **Apertura mm 14, lunghezza 107 mm.** A norma EN362 - EN12275.

ANC0671 - connettore in alluminio, peso 125 gr



12 CONNETTORE AGGANCIO A PUNTI DI ATTACCO STERNALE

Per imbracature con fettucce sternali da congiungere. Chiusura senza possibilità di impiglio, bloccaggio con ghiera automatica a 3 movimenti. **Apertura 16 mm, lunghezza 103 mm.** A norma EN362 - EN12275.

ANC3142 - connettore in alluminio, peso 88 gr



13 MOSCHETTONE IN ACCIAIO

Chiusura senza possibilità di impiglio della fune, bloccaggio con ghiera a 2 movimenti, apertura mm 17, lunghezza 109 mm. A norma EN362 - EN12275.

ANC1878 - moschettone, peso 200 gr



14 MOSCHETTONE IN LEGA DI ALLUMINIO

Chiusura senza possibilità di impiglio della fune, bloccaggio con ghiera a vite, apertura 20, mm lunghezza 110 mm. A norma EN362 - EN12275.

ANC2123 - moschettone, peso 71 gr



15 MOSCHETTONE IN LEGA DI ALLUMINIO

Chiusura senza possibilità di impiglio della fune, bloccaggio con ghiera automatica a 2 movimenti, apertura 20 mm, lunghezza 110 mm. A norma EN362 - EN12275.

ANC2124 - moschettone, peso 76 gr



16 MOSCHETTONE IN LEGA DI ALLUMINIO

Chiusura senza possibilità di impiglio della fune, bloccaggio con ghiera automatica a 3 movimenti, apertura 20 mm, lunghezza 110 mm. A norma EN362 - EN12275.

ANC2125 - moschettone, peso 77 gr

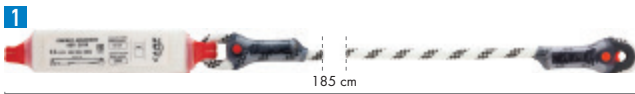

185 cm



115-170 cm

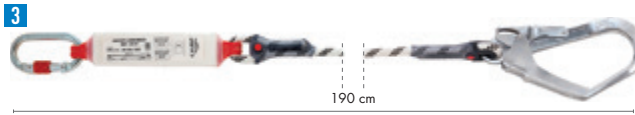

190 cm



190 cm

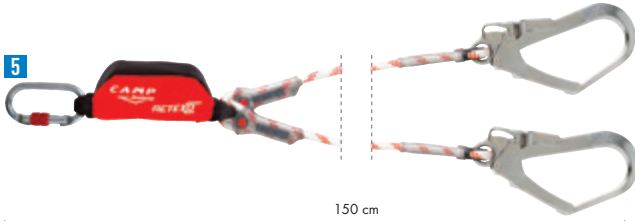

150 cm

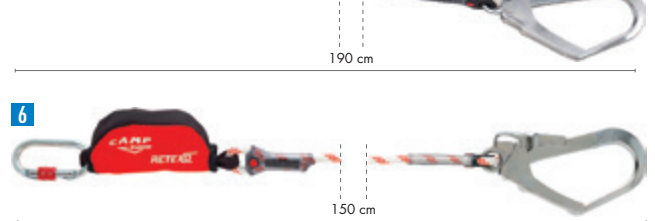

150 cm

CORDINI ANTICADUTA CON ASSORBITORE DI ENERGIA STANDARD



In corda statica in poliammide da 10,5 mm, equipaggiati con assorbitori di energia standard, estensione massima: fattore di caduta 1 = 90 cm fattore di caduta 2 = 160 cm. Massima forza di arresto: 6 kN. Certificati per uso orizzontale su spigolo vivo ($r > 0,5$ mm) in combinazione con i dispositivi anticaduta retrattili Cobra. A norma EN355. Vedi tabella a pagina 420.

- 1 **ANC5030101** - cordino con assorbitore privo di moschettoni, lunghezza 185 cm, peso 390 gr
- 2 **ANC5130101** - cordino con assorbitore privo di moschettoni, con regolazione della lunghezza da 115 a 170 cm, peso 540 gr
- 3 **ANC5030106** - cordino con assorbitore, 1 moschettone ANC0981 e 1 moschettone ANC2017, lunghezza totale 190 cm, peso 1020 gr
- 4 **ANC5030201** - cordino a Y con assorbitore, 3 moschettoni: 1 ANC0981 e 2 ANC2017, lunghezza totale 190 cm, peso 1690 gr

CORDINI ANTICADUTA RETEXO ROPE CON ASSORBITORE DI ENERGIA



Bracci in corda semi-statica Prium 10,5 mm con assorbitore di energia di ultima generazione, leggero e compatto. Certificati per utilizzo orizzontale su spigolo vivo ($r \geq 0,5$ mm). A norma EN355.

- 5 **ANC5050202** - cordino con assorbitore con 1 moschettone ANC0981 e 2 connettori ANC2017, lunghezza totale cm 1580 gr
- 6 **ANC5050103** - cordino con assorbitore con 1 moschettone ANC0981 e 1 connettore ANC2017, lunghezza totale cm 150, peso 1010 gr



lunghezza 100, 150 o 200 cm



8



9

7 CORDINI EN354



In corda statica di poliammide da mm 10,5, possono essere usati anche come dispositivi di ancoraggio. Forniti privi di moschettoni. A norma EN354 - EN795/B.

- ANC2030100** - cordino anticaduta, lunghezza cm 100, peso 140 gr
- ANC2030150** - cordino anticaduta, lunghezza cm 150, peso 180 gr
- ANC2030200** - cordino anticaduta, lunghezza cm 200, peso 220 gr

8 CORDINO DI POSIZIONAMENTO REGOLABILE



Cordino di posizionamento regolabile semi-statico Ø 10.5 mm. In poliammide, con redancia di protezione in polipropilene. Carico di rottura: 27.50 kN A norma EN358. Peso 280 gr.

- ANC203007** - cordino di posizionamento regolabile (lunghezza da 115 a 200 cm)
- ANC2030071** - cordino di posizionamento regolabile (lunghezza da 80 a 125 cm)

9 CORDINO DI POSIZIONAMENTO REGOLABILE CON CONNETTORI



In corda semi-statica in poliammide Ø 12.5 mm, regolatore in lega d'alluminio. Guaina di protezione tubolare per utilizzo come ancoraggio attorno a strutture. Fornito con 2 connettori: 1 ovale chiusura automatica 3 movimenti, in lega d'alluminio resistenza 28kN, apertura 20 mm e 1 con doppia leva, in lega d'alluminio, resistenza 30 kN, apertura 23 mm. A norma EN358.

- ANC203101** - cordino (lunghezza da 0,5 a 2 mt), peso 720 gr
- ANC203115** - cordino con connettori (lunghezza da 0,5 a 2 mt), peso 910 gr



10

10 CINTURA EASY BELT



Cintura di posizionamento sul lavoro. Utilizzo da soli o in abbinamento alle imbracature. Imbottitura ergonomica di sostegno triplo strato con fettuccia in poliestere 44 mm. Cuciture ad alta resistenza, 5 anelli porta materiali, 2 anelli a D di posizionamento in acciaio. A norma EN358. Peso 520 gr.

- ANC1268M** - cintura taglia S - L (70 - 110 cm)
- ANC1268L** - cintura taglia L - XXL (90 - 130 cm)



11

12



ZAINI



Zaini cilindrici, ideali per il trasporto di DPI e attrezzature anticaduta.

- 11 **ANC1984** - zaino in PVC con spillacci imbottiti e regolabili, Ø 32 x 55 cm. Chiusura interna con bloccacordino (A). Maniglia posteriore per il sollevamento (carichi fino a 50 kg). Capacità 40 lt. Peso 950 g.
- 12 **ANC2782** - zaino cilindrico in poliestere Ø 24 x 46 cm, chiusura con blocco cordino (A), tracolla regolabile. Capacità 15 lt



1



NEW

1 IMBRACATURA H500 IC6



Imbracatura facile da indossare grazie al sistema antigroviglio. Cinghie di regolazione laterali, imbottitura per spalle e schiena altamente traspirante, leggera ed ergonomica. Taglio ad H per le gambe. Fibbie per gambe e torace a rilascio automatico, fermi per cordino ripristinabili e collegamento al sistema di salvataggio a ritrazione automatica (SRL). Portata fino a 140 kg.

DAMH500. - imbracatura H500 IC6 con anello a D, taglie fornibili: 1, 2, 3

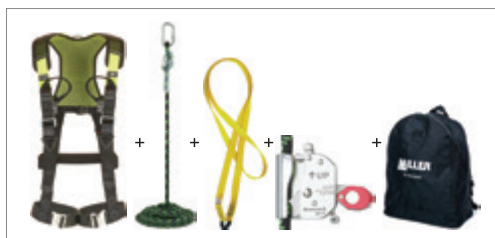

2 KIT H500 "MANUTENZIONE"



Pratica soluzione in kit, studiata per gli utilizzatori che non sanno quali DPI abbinare. Il kit include:

- imbracatura DAMH500.
- dispositivo anticaduta RG500 con cursore
- fune Ø 12 mm da 10 metri, con un moschettone leggero
- feltuccia di ancoraggio 1,5 metri
- zaino colore nero

DAMKITMH500 - kit 5 pezzi, ideale per manutenzioni

2



NEW



3 KIT H500 "PONTEGGI"



Pratica soluzione in kit, studiata per gli utilizzatori che non sanno quali DPI abbinare. Il kit include:

- imbracatura DAMH500.
- cordino Titan doppio, lunghezza 2 metri con assorbitore di energia
- zaino colore nero

DAMKITPH500 - kit 3 pezzi, ideale per ponteggi



NEW



NEW

4 IMBRACATURA H100



Imbracatura economica di qualità. Leggera (800 grammi) e confortevole, con protezione per etichette di identificazione. Anelli porta cordino e cinturino sub-pelvico e ferma nastro. Portata fino a 140 kg.

DAMH100 - imbracatura H100, taglia unica



GUARDA IL VIDEO!

5 KIT TREPPIEDE REGOLABILE DURAHOIST 3POD



Sistema di arresto caduta per spazi confinati. Facile da trasportare e spostare con una sola mano, installazione facile e sicura in meno di 2 minuti (tutte le gambe si aprono simultaneamente e una sola manopola fissa tutte le gambe insieme). Adattabile a botole di dimensioni diverse (1 m - 1,50 m - 2,50 m), collaudato per 2 persone (140 kg max ciascuna). Composto da:

- treppiede a norma EN795:2012 B
- dispositivo anticaduta MightEvac da 15 m a norma EN360:2002
- staffa

Il sistema deve essere integrato con un'imbracatura (acquistabile separatamente) e può essere integrato con organo per il sollevamento di carichi o con dispositivo anticaduta da 30 m anziché da 15 m come previsto dal kit (richiedi quotazione).

DAM4910 - kit treppiede composto da: treppiede, dispositivo anticaduta da 15 metri e staffa

5





SISTEMA DI RECUPERO PER SPAZI CONFINATI



Il lavoro in spazi confinati presenta una serie di difficoltà operative e problematiche riguardanti la sicurezza, dovute principalmente agli spazi ridotti che limitano la movimentazione, alle atmosfere/ambienti sospetti di inquinamento ed alla difficoltà oggettiva di portare a termine le operazioni di soccorso in caso di emergenza. L'utilizzo di dispositivi adeguati, unito ad una formazione ed addestramento specifici degli operatori deve ambire, oltre all'arresto di un'eventuale caduta, a garantire la possibilità di evacuazione immediata in caso di incidente, direttamente dall'esterno. Il sistema di recupero per spazi confinati è composto da:

- **Treppiede** in alluminio a norma EN 795/B, trasportabile, con gambe telescopiche in lega d'alluminio e catena in acciaio per connessione gambe.
- **Dispositivo di recupero** (20 mt) a norma EN1496 con cavo in acciaio e dispositivo di freno automatico.
- **Dispositivo anticaduta** retrattile a norma EN360 da 10 o 20 mt con cavo in acciaio zincato con assorbitore di energia integrato e connettore girevole, carico di rottura 12 kN.

- 1 ANC1883** - treppiede di sicurezza in lega di alluminio, peso kg 17
- 2 ANC0284** - dispositivo di recupero con cavo in acciaio da 20 mt
- 3 ANC3137** - dispositivo anticaduta retrattile con cavo in acciaio zincato da 10 mt

In alternativa:

ANC3139 - dispositivo anticaduta retrattile con cavo in acciaio zincato da 20 mt

A corredo:

- 4 ANC0981** - moschettone in acciaio (necessari 2 pezzi)
- 5 ANC1269** - dispositivo di ancoraggio a 5 fori mm 5 x 19

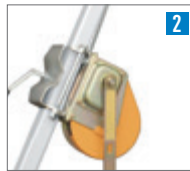

IL SISTEMA È COMPOSTO DA:

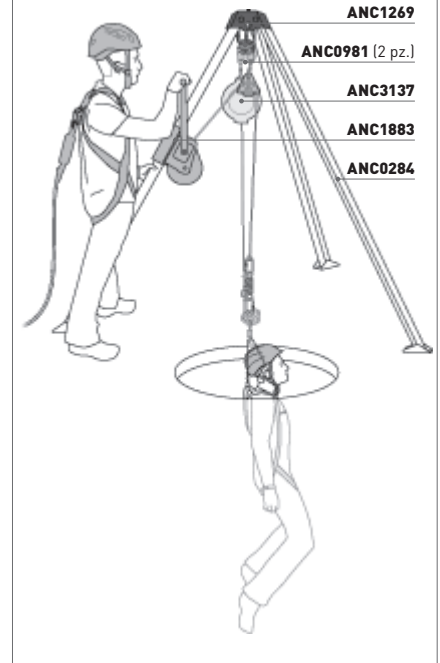

UNA DELLE POSSIBILITÀ DI RECUPERO NEGLI SPAZI CONFINATI AVVIENE ATTRAVERSO L'UTILIZZO DI UN TREPPIEDE ABBINATO A UN DISPOSITIVO DI SOLLEVAMENTO IN MODO CHE, IN CASO DI INCIDENTE, L'OPERATORE POSSA ESSERE RECUPERATO VELOCEMENTE. MOLTO SPESSO È NECESSARIO L'UTILIZZO CONGIUNTO DI UN SISTEMA DI ARRESTO - CADUTA.

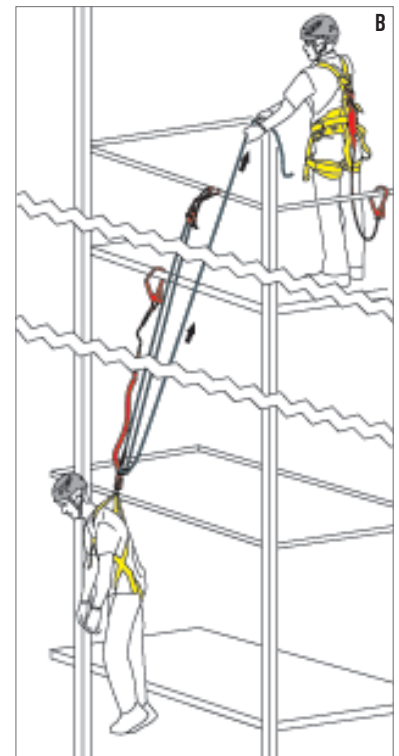
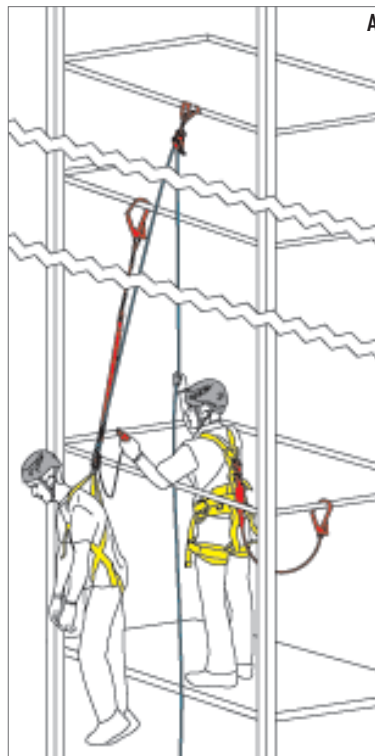

6 SISTEMA PER IL SOCCORSO SU PONTEGGI "RESCUE KIT DRUID"

Rescue Kit Druid è un dispositivo per il recupero su ponteggi o altre strutture verticali, pronto all'uso in caso di incidente. Permette un veloce e semplice soccorso tramite l'aggancio all'infortunato, il taglio del cordino di connessione e la calata a terra (A), oppure è possibile creare un paranco per il sollevamento dell'infortunato per lo sgancio del cordino senza taglio (B).

ANC2196 - Rescue Kit Druid da 20 mt, peso 3,2 kg



1

2

3

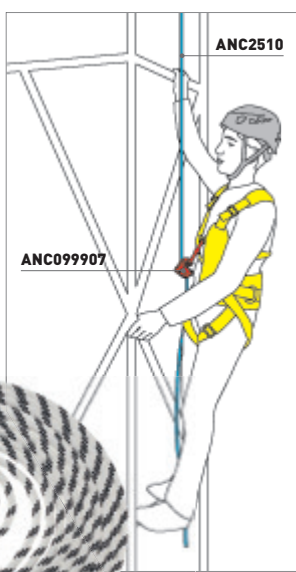

ANC2510

ANC099907



1 KIT DISPOSITIVO ANTICADUTA BLIN



Sistema anticaduta semplice e intuitivo, idoneo sia per uso verticale che per uso orizzontale/inclinato su spigolo vivo ($r \geq 0,5$ mm). Struttura in lega di alluminio e meccanismo in acciaio inox. Scorrimento migliorato grazie al dispositivo Rope Surfer di cui sono equipaggiate le fettucce di collegamento. Fornito con robusta corda semi-statica Iridium 10,5 mm asolata, disponibile in diverse lunghezze. Carico massimo di utilizzo: 120 kg (uso verticale), 100 kg (uso orizzontale/inclinato). Carico di rottura 15 kN. EN 353-2

ANC256503 - kit Blin con dispositivo di bloccaggio, fettuccia collegamento 26 cm, 2 moschettoni e fune 10 mt, peso 1240 gr

ANC256504 - kit Blin con dispositivo di bloccaggio, fettuccia collegamento 26 cm, 2 moschettoni e fune 20 mt, peso 1950 gr

DISPOSITIVO ANTICADUTA GOBLIN LANYARD



Robusta struttura in alluminio, meccanismo in acciaio inox. Concepito per uno scorrimento fluido sulla corda, sia durante la salita che nelle fasi di discesa. Comprende, per il prolungamento, una fettuccia apposta da 40 cm. Non necessita di assorbitore di energia. Due modi di funzionamento: anticaduta e bloccante per risalita, selezionabili con un semplice pulsante. Le funi Lithium mm 10,5 vengono consegnate con estremità asolate e coperte in plastica, resistenza 22 kN.

2 ANC099907 - dispositivo Goblin EN 12841/A-B EN353-2, fettuccia EN354, 2 moschettoni EN362 (componenti forniti smontati), peso 665 gr.

3 ANC2510 - fune 10 mt, peso 750 gr

ANC2520 - fune 20 mt, peso 1,4 kg

ANC2530 - fune 30 mt, peso 2,05 kg

Articoli anticaduta per attrezzi



4

5

6

7

CORDINO PORTA ATTREZZI



Cordini porta attrezzi elastico. Riduce il rischio di cadute accidentali o rotture. Per utensili con portata fino a 4,5 kg. Lunghezza cordino 96 - 123 cm. Conforme ANSI / ISEA 121-2018.

4 EDS311 - cordino per attrezzi con 2 moschettoni

5 EDS310 - cordino per attrezzi con 1 moschettoni

6 GANCIO PORTA OGGETTI



Impedisce la caduta di oggetti, prevenendone la rottura. Doppia clip, si aggancia a cinture, anelli a D, indumenti, ecc... In materiale dielettrico, robusto e resistente.

EDS340 - gancio porta oggetti colore arancio AV

7 CORDINO PORTA CASCO



Compatibile con elmetti con slot per cuffie. Riduce il rischio di cadute, permettendo di assicurare il casco anche indossando i guanti. Per oggetti con portata fino a 0,9 kg. Lunghezza cordino 58 - 123 cm. Colore giallo.

EDS315 - cordino elastico



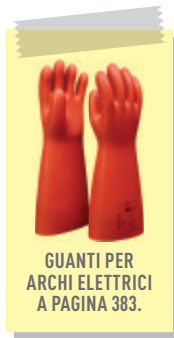

1 GUANTI DIELETRICI



Guanti isolanti in lattice naturale per lavori su impianti sotto tensione. Imballati singolarmente in busta opaca anti U.V., riportante le raccomandazioni d'uso e di conservazione. Lunghezza guanto mm 360 circa. **A norma EN 60903.**

CARATTERISTICHE E CODICI GUANTI DIELETRICI

CODICE	TENSIONE MASSIMA D'UTILIZZO	TENSIONE DI PROVA	CLASSE	TAGLIE	SPESSORE
GD02/..	500 V	2.500 V	00	8-9-10-11	0,5 mm
GD05/..	1.000 V	5.000 V	0	8-9-10-11	1 mm
GD10/..	7.500 V	10.000 V	1	8-9-10-11	1,5 mm
GD20/..	17.000 V	20.000 V	2	8-9-10-11	2,3 mm
GD30/..	26.500 V	30.000 V	3	8-9-10-11	2,9 mm
GD40/..	36.000 V	40.000 V	4	8-9-10-11	3,6 mm

FORMA

Ergonomia studiata per adattarsi alla forma della mano

TOUCH-SCREEN

Non è necessario togliersi i guanti per utilizzare schermi touch-screen

SPESSORE RIDOTTO

Fino al 30% più sottili dei guanti isolanti tradizionali

ARANCIONE

Associazione cromatica al rischio elettrico

CLORINATURA

Facili da indossare



2

ANTISCIVOLO

Presenza sicura degli utensili e delle miniature

1000 V CA / 1500 V CC

Protezione specifica per i veicoli elettrici/ibridi

2 GUANTI ISOLANTI DIELETRICI



Guanti isolanti dielettrici antiscivolo. Ergonomici, si adattano perfettamente alla forma della mano. Clorinati internamente per essere indossati facilmente. Fino al 30% più sottili dei guanti tradizionali. Non è necessario togliersi i guanti per utilizzare gli schermi touch-screen.

GD36. - guanti dielettrici, taglie 8 - 9 - 10

PIÙ SOTTILI RISPETTO AI GUANTI TRADIZIONALI PER UNA MAGGIORE SENSIBILITÀ!



3 CUSTODIA PER GUANTI

Applicabile a parete e munita di comoda maniglia per il trasporto.

GD43 - custodia per guanti in PVC rigido, dimensioni mm 430 x 170 x 50



VERIFICATORI PNEUMATICI PER GUANTI

Pratici e leggeri, consentono di verificare la buona integrità e la perfetta tenuta dei guanti isolanti secondo la norma EN60903.

4 CD44 - verificatore pneumatico per guanti

5 CD45 - verificatore pneumatico per guanti Touch-E con magneti, Ø 100mm

CD46 - verificatore pneumatico per guanti Electrosoft e Flash&Grip con magneti, Ø 130 mm

STIVALI E TRONCHETTI DIELETRICI



Stivali e tronchetti isolanti in gomma dielettrica per lavori sotto tensione: proteggono i lavoratori dai rischi di step-voltage. Testati 10.000 V, suola antiscivolo, fodera interna, sottopiede. Misure: dal 37 al 47 (37/38, 40/41 e 46/47, accorpate). A norma EN 50321:2018 - EN ISO 20347:2012 OB E HRO - EN 13287 - UE 2016/425. DPI III^A categoria.

6 ZCD519.. - stivali dielettrici, altezza cm 37, peso 1910 gr

7 ZCD510.. - tronchetto dielettrico, altezza cm 33, peso 1830 gr





PROTEZIONE DALL'ELETTRICITÀ

1



1 TAPPETI ISOLANTI IN GOMMA

Superficie antiscivolo ad impronta tela colore grigio. Spessori da mm 3 a 6, collaudati con tensioni di prova da 30.000 a 40.000 Volt. **Fornibili in altezza cm 100, in spezzoni da 2 metri e multipli sino a un massimo di metri precisati in tabella (specificare il numero degli spezzoni). Non propagante la fiamma secondo norma IEC 61111.** Marcatura di collaudo stampigliata sul tappeto ad ogni metro.

CARATTERISTICHE E CODICI TAPPETI ISOLANTI

CODICE	CONFORMITÀ IEC 61111	TENSIONE DI PROVA	TENSIONE DI TENUTA	TENSIONE DI UTILIZZO	SPESORE	LUNGHEZZA MASSIMA
TP030	classe 3	30 kV	40 kVac	26,5 kVac	3,0 mm	10 metri
TP052	classe 4	40 kV	50 kVac	36 kVac	5,2 mm	10 metri
TP060	classe 4	40 kV	50 kVac	36 kVac	6,0 mm	10 metri

2

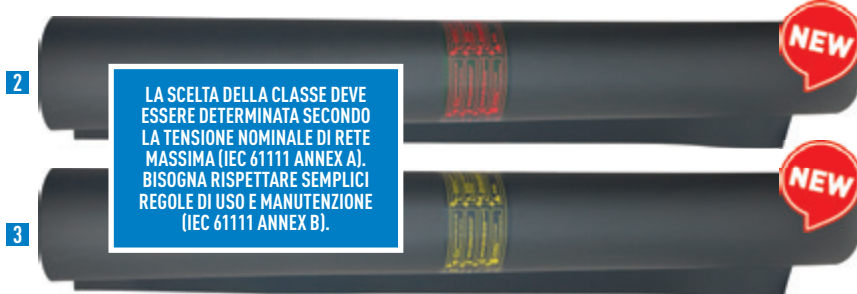

LA SCELTA DELLA CLASSE DEVE ESSERE DETERMINATA SECONDO LA TENSIONE NOMINALE DI RETE MASSIMA (IEC 61111 ANNEX A). BISOGNA RISPETTARE SEMPLICI REGOLE DI USO E MANUTENZIONE (IEC 61111 ANNEX B).

TAPPETI ISOLANTI IN ELASTOMERO



In aggiunta ai dispositivi di protezione individuale, il tappeto isola il lavoratore dal suolo evitandogli di essere attraversato dalla corrente in caso di contatto diretto o passaggio di tensione. Tappeti in elastomero ultraleggero che facilita le operazioni in bassa e media tensione, con superficie anti scivolo su entrambi i lati. Istruzioni per l'uso stampate direttamente sul tappeto. **Non propagante la fiamma secondo norma IEC 61111.** Altre misure fornibili a richiesta.

2 **TP01001** - tappeto classe 1, dimensioni cm 100 x 100, peso 3 kg. Tensione massima operativa: 1.000V AC/1.500V DC

TP01010 - tappeto classe 1, dimensioni cm 100 x lunghezza 30 metri, spessore 1,5 mm, peso 30 kg. Tensione massima operativa: 1.000V AC/1.500V DC

TP01006 - tappeto classe 1, dimensioni cm 60 x 100, spessore 1,5 mm, peso 1,84 kg. Tensione massima operativa: 1.000V AC/1.500V DC

3 **TP02001** - tappeto classe 2, dimensioni cm 100 x 100, spessore 2,5 mm, peso 3,9 kg. Tensione massima d'esercizio: 17.000 V AC/25.500 V DC

TP02010 - tappeto classe 2, dimensioni cm 100 x lunghezza 10 metri, spessore 2,5 mm, peso 39,8 kg. Tensione massima d'esercizio: 17.000 V AC/25.500 V DC

5



TELI ISOLANTI



Telo isolante trasparente in rotoli. Per protezione provvisoria da contatti accidentali nell'esecuzione di lavori su installazioni elettriche in tensione sino a 1000 Volt. Isolamento temporaneo effettuato coprendo parti nude o insufficientemente isolate e conduttori di un elemento di linea BT. Film in PVC ignifugo, isolante elettrico. A norma CEI 61112 Classe0 (1000 V).

4 **TI310R** - rotolo m 25 x 1,3, spessore mm 3, peso kg 13,9

TI315R - rotolo m 12,5 x 1,3, spessore mm 3, peso kg 6,6

5 **TI60P** - pinza per fissaggio rotoli



6

6 OCCHIALE SENZA PARTI METALLICHE



Design essenziale ed avvolgente **senza parti metalliche**. Stanghette regolabili in inclinazione in morbido materiale bicomponente. Ridotta sensazione di pressione sulla faccia per gran comfort in caso di uso continuativo. Resistenza al calore "T" (+55°C / - 5°C). Peso g 27. A norma EN166 1 F.

APD8330 - lente incolore antigraffio e antiappannante, stanghette colore blu



7

7 PEDANA ISOLANTE

Pedana isolante da interno per operazioni di manutenzione elettrica, lavori di prima categoria o manovre d'apparecchi di sezionamento di 2 o 3 categoria a comando manuale (sezionatore). Protezione dielettrica dell'operatore contro la tensione di passaggio.

PD1524 - isolamento 24.000 V, ingombro cm 50 x 50, h cm 15, peso 3,6 kg

PD1545 - isolamento 45.000 V, ingombro cm 50 x 50, h cm 25, peso 3,9 kg

8



8 MAGNETE PER TELI ISOLANTI

Magnete isolante utilizzato per fissare i teli isolanti durante gli interventi sui quadri elettrici. Utilizzabile anche per la copertura dei pacchi batteria dei veicoli elettrici. Nessuna parte conduttrice raggiungibile o visibile. Tensione massima di utilizzo: 1.000V AC / 1.500V DC. Forza di sollevamento: 4 kg. Magnete Ø 40 mm. Impugnatura grande (80 mm) per un facile utilizzo anche con i guanti isolanti.

MSM01 - magneti per teli isolanti, peso 140 gr



A RICHIESTA FORNIBILI SCALE APRIBILI IN VETRORESINA, ISOLAMENTO ELETTRICO 20.000 VOLT/CM², CONFORMI ALLA NORMA EUROPEA UNI EN131. COD. HSD150 - SCALA CON 3 GRADINI COD. HSD225 - SCALA CON 6 GRADINI



FIORETTI ISOLANTI PER MANOVRA SEZIONATORI

In resina poliestere rinforzata con fibra di vetro, lavorazione a fibre unidirezionali. Paramano di delimitazione in gomma, tappo di chiusura isolante. **Collaudo S.M.P. - ENEL.**

- 1 FRE0150 - gancio filettato a ricciolo**, lunghezza m 1,50, Ø 32 mm, isolamento 50 KV
- FRE0200 - gancio filettato a ricciolo**, lunghezza m 2,00, Ø 32 mm, isolamento 90 KV
- 2 FRM150 - gancio fisso a ricciolo**, lunghezza m 1,50, Ø 32 mm, isolamento 50 KV
- FRM200 - gancio fisso a ricciolo**, lunghezza m 2,00, Ø 32 mm, isolamento 90 KV
- FRM250 - gancio fisso a ricciolo**, lunghezza m 2,50, Ø 40 mm, isolamento 110 KV
- FRM300 - gancio fisso a ricciolo**, lunghezza m 3,00, Ø 40 mm, isolamento 150 KV

3 FIORETTO ISOLANTE

Per l'estrazione e innesto dei fusibili (conforme alla prescrizione tecnica ENEL EA 0375). Dotato di idonea morsa per fusibili Ø 30÷90 mm. È corredato di un dispositivo dinamometrico che limita la coppia di serraggio e garantisce comunque la presa.

FRF150 - lunghezza m 1,5, Ø 40 mm. Isolamento 30 KV

4 FIURETTI ISOLANTI DI SALVATAGGIO

Attrezzi ad alto isolamento in resina sintetica rinforzata con fibre di vetro. Paramano di delimitazione e tappo di chiusura. Gancio filettato in acciaio rivestito da guaina in plastica. Il fioretto lungo 4 metri è in due spezzoni da 2 m cadauno con raccordo rapido di giunzione.

FRS200 - lunghezza m 2,00, isolamento 63 KV

FRS300 - lunghezza m 3,00, isolamento 110 KV. Fornito in 2 spezzoni da m 1,5 con raccordo rapido di giunzione

FRS400 - lunghezza m 4,00 (2 da 2 m), isolamento 225 KV



6 DISPOSITIVO DI MESSA A TERRA

Dispositivo per cabine e impianti a media e bassa tensione, valore della corrente di circuito: 12,4 kA eff/1 s. **Composto da:** 3 pinze di contatto universali in ottone per: conduttori tondi, barre piatte, barre in costa, barre inclinate - 3 cavi di corto circuito, extraflessibili, in rame elettrolitico rivestito con guaina trasparente; sezione mq 50, lunghezza m 0,75 - 1 cavo di messa a terra c.s., lunghezza m 2,0 - 1 connettore di triforcazione - 1 morsetto di terra, serraggio fino a mm 22 - 1 fioretto isolante in vetroresina di m 1,35, in due spezzoni + raccordo rapido di giunzione - 1 cassetta metallica per trasporto e custodia. **Certificato in conformità alla norma: CEI EN 61230.**

DMT5004 - dispositivo di messa a terra



FIURETTI ISOLANTI

10 RMT3090F - fioretto lunghezza m 2,00 per RMT3090V in sacca. Utilizzabile fino a tensioni di 130 KV

11 RMT1030F - fioretto lunghezza m 1,20 per RMT1030V e RMT1133V in sacca (A). Utilizzabile fino a tensioni di 30 KV



RILEVATORE DI TENSIONE

Rilevatore elettronico unipolare e/o bipolare di tensione BT a segnale sonoro e luminoso. Alimentazione a batteria alcalina 9V. Puntaletto in nylon con elettrodo di contatto in ottone stagnato con rivestimento in gomma. Contenitore in ABS rinforzato con fibre di vetro. Dimensioni: mm 200 x 40 x 40. **Campo di misura:** bipolare 25-500 V c.a., bipolare 50-750 V c.c., unipolare 50-500 V c.a. **Conforme alla prescrizione tecnica ENEL EA 0118.**

5 RBT750 - rivelatore di tensione

6 RBT750A - antenna per uso rivelatore di tensione RBT750 su linea aerea



RILEVATORE ASSENZA/PRESENZA TENSIONE

Doppia segnalazione di presenza di tensione, acustica intermittente e luminosa lampeggiante a mezzo di 2 LED rossi. Assenza di tensione indicata dal permanere in funzione del LED verde. Alimentazione: batteria alcalina 9V (inclusa). **Conformi alla norma: CEI IEC 61243-1 Ed. 2 2003 - 10.**

7 RMT1030V - rivelatore per tensioni da 10 a 30 KV. Puntaletto di contatto in ottone stagnato (fioretto escluso)

8 RMT3090V - rivelatore per tensioni fino a 400 KV. Puntaletto di contatto a forma di gancio in alluminio (fioretto escluso)

9 RILEVATORE ASSENZA /PRESENZA TENSIONE

Segnalazione di presenza di tensione luminosa lampeggiante a mezzo di 4 LED rossi. Puntaletto di contatto in ottone stagnato e dispositivo di autocontrollo incorporato.

RMT1133V - rivelatore assenza /presenza per tensioni da 3 a 45 KV, segnale solo luminoso in cassetta metallica (fioretto escluso)



PROTEZIONI PER LA SALDATURA

DIN EN ISO 25980:2015-01 (EX 1598)

Disponibile nella colorazione classica:

LANSARC OR (rossa)

Trasparente. Protettiva UVIR e luce blu:

LANSARC FE (bronzo)

Trasparente. Protettiva con attenuazione del bagliore:

LANSARC R9 (verde scuro)

Opaca. Non trasparente. Per protezioni laterali

ravvicinate o per elevati amperaggi:

LANSARC RO (incolore)

Indicazioni e normative presenti in ogni singola striscia (lato alto a sinistra)



1 TENDE DI PROTEZIONE LANSARC®

Tende per cabine di saldatura. Forniscono uno schermo totale contro i raggi ultravioletti e la luce blu. I modelli TLA180 e TLA200 sono trasparenti e luminosi e quindi eliminano la sensazione di isolamento degli operatori illuminando il posto di lavoro. Resistono tutte alle proiezioni incandescenti, e sono autoestinguenti. Sono disponibili in larghezza standard di cm 140, in diverse altezze, e vengono fornite munite di occhiellatura sulla parte superiore e di bottoni automatici maschio/femmina ai lati per la formazione di complessi modulari. I ganci (TLK007) vengono forniti a parte. **Conforme alla norma EN ISO 25980.**

LANSARC OR - tenda di colore rosso

LANSARC R9 - tenda verde **non trasparente**

TLG918 - tenda Lansarc R9 cm 140 x 180 h

TLG920 - tenda Lansarc R9 cm 140 x 200 h

TLA180 - tenda Lansarc OR cm 140 x 180 h

TLA200 - tenda Lansarc OR cm 140 x 200 h

TLK007 - kit di n° 7 ganci per una tenda

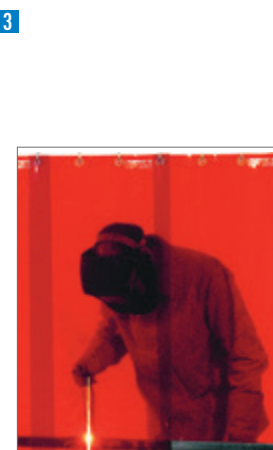
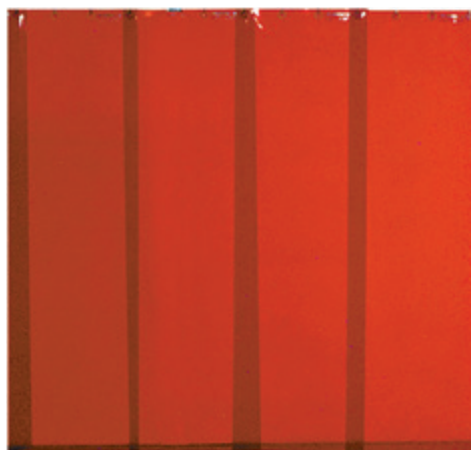

TENDA-STRISCIA

La tenda-striscia unisce i vantaggi della tenda tradizionale e della striscia. Il particolare sistema di aggancio della tenda-striscia permette un facile montaggio con ganci (forniti a parte) e anelli rinforzati. Si monta rapidamente e si adatta a tutte le strutture. Ideale per operazioni di saldatura a gas e ad arco elettrico. Fornita nelle versioni Lansarc OR (colore rosso) e Lansarc R9 (colore verde, non trasparente). **Conforme alla norma EN ISO 25980.**

2 La scatola di tende a strisce 470 x 0,4 mm contiene: 5 strisce per un totale utile di mm 2000 di larghezza. Ogni striscia si sovrappone automaticamente di 35 mm e dispone di 4 occhielli rinforzati.

TLT318 - scatola da 5 strisce Lansarc R9 mm 2000 x 1800 h

TLT320 - scatola da 5 strisce Lansarc R9 mm 2000 x 2000 h

TLT716 - scatola da 5 strisce Lansarc OR mm 2000 x 1600 h

TLT718 - scatola da 5 strisce Lansarc OR mm 2000 x 1800 h

TLT720 - scatola da 5 strisce Lansarc OR mm 2000 x 2000 h

TLK016 - kit da 16 ganci per ogni scatola di 5 tende a strisce

3 La scatola di tende a strisce 570 x 1 mm contiene: 4 strisce per un totale utile di mm 2000 di larghezza. Ogni striscia si sovrappone automaticamente di 35 mm e dispone di 4 occhielli rinforzati.

TLT816 - scatola da 4 strisce Lansarc OR mm 2000 x 1600 h

TLT818 - scatola da 4 strisce Lansarc OR mm 2000 x 1800 h

TLT820 - scatola da 4 strisce Lansarc OR mm 2000 x 2000 h

TLK013 - kit da 13 ganci per ogni scatola di 4 tende a strisce

LE TENDE DI PROTEZIONE E LE TENDE-STRISCIA PRESENTATE IN QUESTA PAGINA NON SONO COMPRENSIVE DI STRUTTURA METALLICA DI SOSTEGNO. PER KIT COMPLETI DI TALE STRUTTURA VEDERE, ALLA PAGINA SUCCESSIVA, I CODICI TLK...



1 SCHERMO A TRE ANTE



Box mobile di protezione per saldatura che permette di creare una protezione costante in qualsiasi zona dell'officina, grazie alle illimitate possibilità di realizzazione. Lo schermo mobile permette di realizzare installazioni non permanenti; stabile e robusto, mobile ed estensibile grazie alle ante laterali, è composto da tre ante con tenda-striscia. **Conformi alla norma EN ISO 25980** per tutte le applicazioni di saldatura ad arco. **Caratteristiche costruttive:** tubolare metallico trattato con vernice antiurto, colore nero epoxy - larghezza totale mm 4100 - piedini con 4 rotelle e 2 freni - altezza mm 1950 - distanza da terra mm 400. **Kit completo, pronto per il montaggio.** Fornite nelle versioni Lansarc OR (colore arancio) e Lansarc R9 (colore verde, non trasparente).

- TLK240** - schermo a tre ante con strisce Lansarc OR mm 570 x spessore mm 1
- TLK940** - schermo a tre ante con strisce Lansarc R9 mm 570 x spessore mm 1
- TLK244** - schermo a tre ante con strisce Lansarc OR mm 470 x spessore mm 0,4
- TLK944** - schermo a tre ante con strisce Lansarc R9 mm 470 x spessore mm 0,4



2 LANSKIT



Schermo modulare Lanskit equipaggiato con tenda-striscia Lansarc OR colore rosso, **conforme alla norma EN ISO 25980**. Consente di realizzare una barriera protettiva portatile che permette il passaggio degli operatori. Lo schermo Lanskit è fornito in kit e la sua installazione richiede poche e semplici operazioni. Realizzato in tubo d'acciaio verniciato, grazie ai piedini ad incastro può essere usato per formare dei box per le operazioni di saldatura.

- TLK200** - Lanskit con tenda Lansarc OR, cm 200 x 190 h, spessore mm 0,4



3 TRANSLIGHT 2400 MV



Maschera di protezione per saldatori con **filtro optoelettronico variabile**. Indice di protezione variabile da 9 a 13 DIN, alimentazione a celle solari, tempo di reazione 0,3 ms, tempo di ritorno al chiaro regolabile, sensibilità regolabile, **campo visivo Ultra Vision**, 3 sensori luce, oscuramento variabile 3 - 9/13 DIN. Dimensioni area visiva: 98 x 40 mm. Peso: g 510. A norma EN166 - EN379 - EN175.

- TRT2400** - maschera con cassetta ad indice di protezione variabile
- TRR4700** - kit da 10 lastrine in policarbonato mm 148 x 90

4 WH40 SCORPION



Maschera di protezione per saldatori con **filtro optoelettronico a indice variabile**. Indice di protezione variabile da 9 a 13 DIN esterno, alimentazione a celle solari, tempo di reazione 0,3 ms, tempo di ritorno al chiaro regolabile, sensibilità regolabile, poggiatesta. Dimensioni area visiva: 98 x 40 mm. Peso netto: g 400. A norma EN166 - EN379 - EN175.

- TRT3800** - maschera completa di cassetta con indice variabile
- TRR8301** - kit da 10 lastrine in policarbonato mm 97 x 110



STRISCE DI PROTEZIONE PER LA SALDATURA



Colore arancio, spessore 2 mm, stesse caratteristiche di assorbimento dei raggi delle tende. Alta resistenza meccanica, consentono in maniera agevole il passaggio di carrelli e persone. Si applicano con le apposite briglie di sospensione. Per ogni striscia sono necessari 1 briglia ed 1 distanziatore. **Conformi alla norma EN ISO 25980.**

- 5 TLS500** - rotolo Lansarc OR, lunghezza 10 m x altezza cm 30
- 6 TLS010** - distanziatore per strisce in plastica azzurra
- 7 TLS030** - briglia di sospensione in plastica azzurra



CUSTODIE E ARTICOLI PER DISINFEZIONE D.P.I.



1



2

A RICHIESTA FORNIBILI
ALTRE TIPOLOGIE DI
CUSTODIE PER D.P.I.
RICHIEDI UN RPEVENTIVO!



3



4



5

CUSTODIE SECUBOX

Custodie per D.P.I. in ABS. Resistenti, sicure e di facile applicazione alle pareti oppure ai macchinari, custodiscono e proteggono i Dispositivi di Protezione Individuale, soddisfacendo i requisiti delle norme in fatto di cura e manutenzione. L'umidità, la polvere, gli schizzi ed i residui di sostanze varie possono danneggiare i DPI. Le custodie possono contenere guanti, cuffie auricolari, tute, semimaschere, visiere, elmetti o maschere a pieno facciale. Simboli autoadesivi fornibili separatamente: serie 13...KS (pagine 44-45). *Fornita vuota e senza simboli.*

- 1 **SBB12** - custodia Secubox Mini, colore blu. Dimensioni: cm 23,6 x 12 x 12 h
- 2 **SBB22** - custodia Secubox Midi, colore blu. Dimensioni: cm 23,6 x 12,5 x 22,5 h
- 3 **SBB32** - custodia Secubox Maxi, colore blu. Dimensioni: cm 23,6 x 20 x 31,5 h

4 ARMADIO PER D.P.I.

In acciaio spessore 7/10, colore blu RAL 5015. 2 ripiani regolabili in altezza, 1 ripiano di base, serratura con 2 chiavi, possibilità di fissaggio a muro o su piantana (fornibile a richiesta). **Fornito vuoto.**

AST4565 - armadio per D.P.I., cm 45 x 27 x 65 h

5 SECUBOX FIRST AID

Custodia in ABS colore verde con specchietto interno. Si possono custodire flaconi per lavaggio oculare (max 3 da 500 ml, cod. CSC041 a pag. 441), bende oculari, garze, forbici e cerotti. **Fornita vuota.**

SBV23 - custodia Secubox First Aid, cm 24 x 13 x 23 h

Disinfezione D.P.I.

Prodotti per pulire e disinfettare i Dispositivi di Protezione Individuale.



6

6 SALVIETTINE DISINFETTANTI

Dräger

Salviette usa e getta in confezione da 10 pezzi, fornite con dispenser in cartone. Pronte all'uso, consentono di disinfettare con semplicità le superfici di contatto con il viso delle maschere, semimaschere e qualsiasi altro D.P.I.

RSD54134 - box da 10 pezzi salviette disinfettanti



7

7 SALVIETTINE DISINFETTANTI E DETERGENTI USA E GETTA PER DPI

Puliscono e disinfettano piani e strumenti da lavoro, DPI, ecc. Non necessitano di risciacquo, pronti all'uso con perossido di idrogeno Hi-speed H₂O₂TM. A norma EN 16615.

CRA380 - confezione richiudibile da 100 salviette



8

8 DETERGENTE DISINFETTANTE PER DPI

Detergente-disinfettante per piani e strumenti da lavoro, DPI, monitor, ecc. Non necessita di risciacquo, pronto all'uso con perossido di idrogeno Hi-speed H₂O₂TM. Ampio spettro di efficacia. Agisce rapidamente. Eccellente compatibilità con diversi materiali. Sicurezza garantita per l'utilizzatore, il principio attivo si decompone in acqua e ossigeno. A norma EN 16615 (requisiti minimi dell'attività batterica e fungicida).

CRA160 - dispenser a spruzzo disinfettante, detergente da 750 ml





ARTICOLI PER EMERGENZA E PRIMO SOCCORSO

ARMADIETTI E VALIGETTE DI MEDICAZIONE LINEA "FLUO" SAFE IN®	435-436
ARMADIETTI E VALIGETTE DI MEDICAZIONE ALLEGATO 1 "MAGGIORATO"	436
ARMADIETTI E VALIGETTE DI MEDICAZIONE ALLEGATO 1 E 2	437-438
ARMADIETTI E VALIGETTE DI MEDICAZIONE ALLEGATO 3 E VUOTE	439
VALIGETTE, BORSE DI MEDICAZIONE E KIT SPECIALI	440-441
AUSILI PER LA MEDICAZIONE E DISPENSER CEROTTI	442-443
SFIGMOMANOMETRI E RIANIMATORI	444
FORBICI E ARTICOLI VARI PER IL PRIMO SOCCORSO	445
BARELLE, FERMACAPO E DEFIBRILLATORE	446-447
PRODOTTI ANTIUSTIONE E KIT PRONTO INTERVENTO	448
ATTREZZATURE PER INFERMERIE AZIENDALI	449
DOCCE E LAVAOCCHI DI EMERGENZA	451-458

PRIMO SOCCORSO: REGOLAMENTI E NORMATIVE

DECRETO 15 LUGLIO 2003 N.388

Regolamento recante disposizioni sul pronto soccorso aziendale, in attuazione dell'articolo 15, comma 3, del Decreto Legislativo 19 settembre 1994, n. 626, e successive modificazioni.

ART. 1 - CLASSIFICAZIONE DELLE AZIENDE

Le aziende ovvero le unità produttive sono classificate, tenuto conto della tipologia di attività svolta, del numero dei lavoratori occupati e dei fattori di rischio, in tre gruppi:

GRUPPO A

I) Aziende o unità produttive con attività industriali...centrali termoelettriche, impianti e laboratori nucleari...aziende estrattive ed altre attività minerarie...aziende per la fabbricazione di esplosivi, polveri e munizioni;

II) Aziende o unità produttive con oltre 5 lavoratori appartenenti o riconducibili ai gruppi tariffari INAIL....

III) Aziende o unità produttive con oltre 5 lavoratori a tempo indeterminato del comparto dell'agricoltura.

GRUPPO B

Aziende o unità produttive con tre o più lavoratori che non rientrano nel gruppo A.

GRUPPO C

Aziende o unità produttive con meno di tre lavoratori che non rientrano nel gruppo A.

Il datore di lavoro, sentito il medico competente, ove previsto, identifica la categoria di appartenenza della propria azienda od unità produttiva e, solo nel caso appartenga al gruppo A, la comunica all'Azienda Unità Sanitaria Locale competente sul territorio in cui si svolge l'attività lavorativa, per la predisposizione degli interventi di emergenza del caso. Se l'azienda o unità produttiva svolge attività lavorative comprese in gruppi diversi, il datore di lavoro deve riferirsi all'attività con indice più elevato.

ART. 2 - ORGANIZZAZIONE DI PRONTO SOCCORSO

1. Nelle aziende o unità produttive di gruppo A e B, il datore di lavoro deve garantire le seguenti attrezzature:

a) cassetta di pronto soccorso, tenuta presso ciascun luogo di lavoro... contenente la dotazione minima indicata nell'allegato 1, da integrare sulla base dei rischi presenti nei luoghi di lavoro e su indicazione del medico competente... e della quale sia costantemente assicurata la completezza ed il corretto stato d'uso dei presidi ivi contenuti;

2. Nelle aziende o unità produttive di gruppo C, il datore di lavoro deve garantire le seguenti attrezzature:

a) pacchetto di medicazione, tenuto presso ciascun luogo di lavoro, contenente la dotazione minima indicata nell'allegato 2, da integrare sulla base dei rischi presenti nei luoghi di lavoro, della quale sia costantemente assicurata la completezza ed il corretto stato d'uso dei presidi ivi contenuti;...

5. Nelle aziende o unità produttive che hanno lavoratori che prestano la propria attività in luoghi isolati, diversi dalla sede aziendale o unità produttiva, il datore di lavoro è tenuto a fornire loro il pacchetto di medicazione di cui all'allegato 2.

ART. 5 - ABROGAZIONI

Il Decreto Ministeriale del 28 luglio 1958 è abrogato.

ART. 6 - ENTRATA IN VIGORE

Il presente Decreto entra in vigore sei mesi dopo la pubblicazione nella Gazzetta Ufficiale della Repubblica Italiana Roma, 15 luglio 2003.

ALLEGATO 1

AZIENDE DEI GRUPPI A E B CON 3 O PIÙ LAVORATORI

CONTENUTO MINIMO DELLA CASSETTA DI PRONTO SOCCORSO:

- 5 paia di guanti sterili monouso
- 1 visiera paraschizzi
- 1 flacone di soluzione cutanea di iodopovidone al 10% di iodio da 1 lt
- 3 flaconi di soluzione fisiologica (sodio cloruro 0,9%) da 500 ml
- 10 compresse di garza sterile 10 x 10 in buste singole
- 2 compresse di garza sterile 18 x 40 in buste singole
- 2 teli sterili monouso
- 2 pinzette da medicazione sterili monouso
- 1 confezione di rete elastica di misura media
- 1 confezione di cotone idrofilo
- 2 confezioni di cerotti di vari e misure pronti all'uso
- 2 rotoli di cerotto alto cm 2,5
- 1 paio di forbici
- 3 lacci emostatici
- 2 confezioni di ghiaccio pronto uso
- 2 sacchetti monouso per la raccolta di rifiuti sanitari
- 1 termometro
- 1 apparecchio per la misurazione della pressione arteriosa
- 1 foglio istruzioni: D.M. 388 istruzioni multilingue pronto soccorso

ALLEGATO 1 "MAGGIORATO"

AZIENDE DEI GRUPPI A E B CON 3 O PIÙ LAVORATORI

RISPETTO A QUANTO RICHIESTO DAL D.M. ALLEGATO 1 SONO STATI AGGIUNTI I SEGUENTI PRODOTTI DI MAGGIOR CONSUMO:

- 1 confezione da 8 salviettine (3 disinfettanti, 2 di ammoniaca, 3 di sapone liquido)
- 1 apribocca e rianimatore bocca a bocca (kit completo)
- 1 coperta isotermica
- 1 telo triangolare TNT cm 96 x 96 x 136
- 2 bustine di preparato per ustioni in gel g 3,5
- 2 bende elastiche m 4 x 6 cm
- 1 tampobenda mm 80 x 100
- 4 rotoli di benda orlata cm 10 x 3,5 m

ALLEGATO 2

AZIENDE DEL GRUPPO C CON MENO DI 3 LAVORATORI CHE NON RIENTRANO NEL GRUPPO A

CONTENUTO MINIMO DELLA CASSETTA DI PRONTO SOCCORSO:

- 2 paia di guanti sterili monouso
- 1 flacone di soluzione cutanea di iodopovidone al 10% di iodio da 125 ml
- 1 flacone di soluzione fisiologica (sodio cloruro 0,9%) da 250 ml
- 1 compressa di garza sterile 18 x 40 in busta singola
- 3 compresse di garza sterile 10 x 10 in buste singole
- 1 pinzette da medicazione sterile monouso
- 1 confezione di cotone idrofilo
- 1 confezione di cerotti di varie misure pronti all'uso
- 1 rotolo di cerotto alto cm 2,5
- 1 rotolo di benda orlata alta cm 10
- 1 paio di forbici
- 1 laccio emostatico
- 1 confezione di ghiaccio pronto uso
- 1 sacchetto monouso per la raccolta di rifiuti sanitari
- 1 foglio istruzioni: D.M. 388 istruzioni multilingue pronto soccorso

VALIGETTE E ARMADIETTI LINEA "FLUO"

Linea esclusiva di valigette e armadi di colore giallo fluorescente; indispensabili dove è necessario avere maggiore visibilità, per contrasto con l'ambiente circostante, e renderne più facile l'individuazione.



ALLEGATO 1

1 ARMADIETTO FLUO IN METALLO

Armadietto in metallo verniciato con polvere epossidica. Facilmente individuabile all'interno delle attività lavorative grazie al colore giallo fluorescente. 1 anta, 1 ripiano, serratura con chiave. Contenuto: presidi medici prescritti dall'Allegato 1 D.M. n.388.

BRA101F - dimensioni cm 30 x 12 x 40 h

2 VALIGETTA FLUO IN PLASTICA

Valigetta estraibile in ABS facilmente individuabile all'interno delle attività lavorative grazie al colore giallo fluorescente. Indispensabili all'esterno per le attività connesse all'edilizia e alla manutenzione stradale, dove la scarsa luce solare o la presenza di nebbia e foschia potrebbero impedirne la facile individuazione. Contenuto: presidi medici prescritti dall'Allegato 1 D.M. n.388.

BRV101F - dimensioni cm 42 x 31 x 11 h



ALLEGATO 2

3 ARMADIETTO FLUO IN METALLO

Armadietto in metallo verniciato con polvere epossidica. Facilmente individuabile all'interno delle attività lavorative grazie al colore giallo fluorescente. 1 anta, 1 ripiano, serratura con chiave. Contenuto: presidi medici prescritti dall'Allegato 2 D.M. n.388.

BRA201F - dimensioni cm 30 x 12 x 40 h

4 VALIGETTA FLUO IN PLASTICA

Valigetta estraibile in ABS facilmente individuabile all'interno delle attività lavorative grazie al colore giallo fluorescente. Indispensabili all'esterno per le attività connesse all'edilizia e alla manutenzione stradale, dove la scarsa luce solare o la presenza di nebbia e foschia potrebbero impedirne la facile individuazione. Contenuto: presidi medici prescritti dall'Allegato 2 D.M. n.388.

BRV201F - dimensioni cm 32 x 23 x 8 h



**LATO A
SOCCORSO OCCHI**

**LATO B
KIT USTIONI**

5 VALIGETTA "DOUBLE SAFE"

Avere accesso a un kit di prima emergenza ben fornito ed essere pronti ad agire rapidamente limita il danno e riduce i tempi di recupero. Double Safe è la prima e **unica** stazione di pronto soccorso **per le emergenze oculari e le ustioni** a portata di mano! Minimo ingombro, contiene i dispositivi necessari per il lavaggio oculare e la medicazione funzionale al trattamento delle ustioni di piccola entità. La valigetta è dotata di supporto per attacco a parete, maniglia per trasporto, vetrine che separano i due fondi e chiusura con 2 clip a scatto. Le etichette esterne **KIT LAVAOCCHI (lato A)** e **KIT USTIONI (lato B)** facilitano l'individuazione del lato dove trovare tempestivamente la medicazione necessaria per l'incidente che si è verificato.

BRV500DF - valigetta in ABS giallo fluo. Dimensioni: cm 32 x 21,3 x 12,5



6 STAZIONE DI LAVAGGIO OCULARE FLUO

Stazione di lavaggio in polipropilene con coperchio frontale trasparente. Contiene due flaconi di soluzione dotati di tappo oculare, 1 specchietto, viti e tasselli per il fissaggio a muro.

BRO690 - stazione di lavaggio oculare colore giallo, peso kg 1,20, dimensioni cm 41 x 32 x 7,5



ARMADIETTI E VALIGETTE PORTATILI DI MEDICAZIONE



BRV600F
Valigetta fluo per il settore agricolo con maggiorazione comparto agricoltura.



BRV601F
Valigetta fluo per il settore edile con maggiorazione comparto edilizia.



BRV602F
Valigetta fluo per il settore petrolchimico con maggiorazione comparto OIL&GAS.



BRV603F
Valigetta fluo per il settore alimentare con maggiorazione comparto alimentare.



BRV604F
Valigetta fluo per il settore scolastico con maggiorazione comparto scuola.



BRV605F
Valigetta fluo per il settore tecnico con maggiorazione comparto officine tecniche.

1 VALIGETTE FLUO CON CONTENUTI SPECIFICI

Linea di valigette per il pronto soccorso con **contenuti specifici** che tengono conto degli infortuni statisticamente più probabili legati sia agli strumenti lavorativi sia alle condizioni ambientali in cui il lavoratore opera. Acquistare una valigetta Safeln® significa non solo rispettare la normativa in materia di sicurezza, ma migliorare gli standard di sicurezza sul lavoro per raggiungere l'obiettivo più importante: la salvaguardia della sicurezza e della salute dei lavoratori. Le valigette sono in ABS colore giallo fluo, cm 41 x 15 x 31 h e contengono dispositivi medici: Allegato 1 D.M. n.388 e D.Lgs. 81/08 più le maggiorazioni previste da ogni comparto: disinfezione e protezione cute, rianimazione e immobilizzazione, emostasi, soccorso occhi, tagli e ustioni.



Armadietti e valigette

ALLEGATO 1 "MAGGIORATO"

Per aziende dei gruppi A e B con 3 o più lavoratori. Contenuto: presidi medici prescritti dall'Allegato 1 D.M. n. 388 "maggiorato".



ARMADIETTI IN METALLO

In acciaio al carbonio P02 spessore 6/10, verniciatura in epossipoliestere cottura a forno 180°C. Serratura con chiave, **spigoli arrotondati**.

2 BRA103 - dimensioni cm 32 x 12 x 50 h, con l'aggiunta di prodotti di maggior consumo

3 BRA104 - dimensioni cm 32 x 19 x 45 h, con l'aggiunta di prodotti di maggior consumo



4 VALIGETTA PORTATILE DI MEDICAZIONE

Valigetta di medicazione in ABS colore arancio, due scomparti completi di separatore trasparente. Con l'aggiunta di prodotti di maggior consumo.

BRV102 - dimensioni cm 42 x 31 x 15 h, con supporto per attacco a parete



5 PACCO DI REINTEGRO PER ALLEGATO 1 "MAGGIORATO"

Per BRA103, BRA104 e BRV102. Misuratore di pressione escluso.

BRP101 - pacco di reintegro Allegato 1 "maggiorato", imballo di cartone



Armadietti e valigette ALLEGATO 1

Per aziende dei gruppi A e B con 3 o più lavoratori. Contenuto: presidi medici prescritti dall'Allegato 1 D.M. n. 388.

1



1 ARMADIETTO IN PLASTICA

Armadietto colore bianco, 2 ante, 2 ripiani interni.

BRA102 - in plastica antiurto, dimensioni cm 45 x 13 x 37,5 h

2



2 ARMADIETTO IN METALLO

Armadietto colore bianco, 1 anta, 2 ripiani, serratura con chiave.

BRA101 - in metallo verniciato, dimensioni cm 30 x 12 x 40 h



3

3 VALIGETTA IN POLIPROPILENE

Maniglia per il trasporto, chiusura a clip. Aggancio a parete integrato a due fori.

BRV025 - in polipropilene colore arancio, dimensioni cm 40,5 x 30 x 11,4 h



4

4 VALIGETTA IN ABS ANTIURTO

Con maniglia e supporto per il fissaggio a parete o su automezzi.

BRV101 - in ABS antiurto verde, dimensioni cm 42 x 31 x 11 h

PACCO DI REINTEGRO ALLEGATO 1

Contiene:

- 1 copia Decreto Min. 388 del 15.07.2003
- 5 paia di guanti sterili monouso
- 1 visiera paraschizzi
- 1 litro di soluzione cutanea di iodopovidone al 10% di iodio
- 1500 ml di soluzione fisiologica (sodio cloruro - 0,9%)
- 10 compresse di garza sterile 10 x 20 in buste singole
- 2 compresse di garza sterile 18 x 40 in buste singole
- 2 teli monouso cm 40 x 60
- 2 pinzette da medicazione sterili monouso
- 1 confezione di rete elastica di misura media
- cotone idrofilo
- 2 confezioni di cerotti di varie misure pronti all'uso
- 2 rotoli di cerotto h cm 2,5
- 1 paio di forbici
- 3 lacci emostatici
- 2 confezioni di ghiaccio pronto uso
- 2 sacchetti monouso per la raccolta di rifiuti sanitari
- 1 termometro clinico digitale
- istruzioni sul modo di usare i presidi suddetti e di prestare i primi soccorsi in attesa del servizio di emergenza



5

5 PACCO DI REINTEGRO PER ALLEGATO 1

Per BRA101, BRA102 e BRV101. Misuratore di pressione escluso.

BRP100 - pacco di reintegro Allegato 1, imballo di cartone



Armadietti e valigette ALLEGATO 2

Per aziende del gruppo C con meno di 3 lavoratori che non rientrano nel gruppo A. Contenuto: presidi medici prescritti dall'Allegato 2.



1 ARMADIETTO IN METALLO

Armadietto in metallo verniciato colore bianco, 1 anta, 2 ripiani, serratura con chiave.
BRA201 - armadietto, dimensioni cm 30 x 12 x 40 h

- Con l'aggiunta dei seguenti articoli:
- 2 garze sterili
 - 1 confezione cotone idrofilo
 - 1 benda orlata
 - 1 telo triangolare TNT
 - 1 coperta isotermica
 - 1 confezione da 8 salviettine
 - 1 bustina di preparato per ustioni in gel
 - 1 tampobenda
 - 2 teli per ustioni



2 ARMADIETTO IN PLASTICA

Armadietto in plastica colore bianco, 1 anta, 2 ripiani interni.
BRA202 - armadietto, dimensioni cm 22 x 12 x 34 h



3 VALIGETTA IN POLIPROPILENE

Maniglia per il trasporto, chiusura a clip. Aggancio a parete integrato a due fori.
BRV026 - in polipropilene colore arancio, dimensioni cm 31 x 21 x 9,7 h



4 VALIGETTA IN PLASTICA

In polipropilene antiurto con maniglia e supporto per il fissaggio.
BRV202 - valigetta colore verde, dimensioni cm 32 x 21 x 9 h



5 VALIGETTA IN PLASTICA

In ABS colore arancio, con separatore trasparente e supporto per attacco a parete.
BRV201 - valigetta, dimensioni cm 32 x 21 x 12 h

- Con l'aggiunta dei seguenti articoli:
- 2 garze sterili
 - 1 telo per ustioni
 - 1 confezione da 8 salviettine
 - 1 telo triangolare in TNT



6 PACCO DI REINTEGRO ALLEGATO 2

Per BRA201 e BRA202.
BRP200 - pacco di reintegro Allegato 2, imballo di cartone

PACCO DI REINTEGRO ALLEGATO 2

Contiene:

- 1 copia Decreto Legislativo n° 81/2008
- 2 paia di guanti sterili monouso
- 125 ml di soluzione cutanea di iodopovidone al 10% di iodio
- 250 ml di soluzione fisiologica
- 3 compresse di garza sterile cm 20 x 20
- 1 compressa di garza sterile cm 18 x 40
- 1 pinzetta da medicazione sterile monouso
- 1 cotone idrofilo
- 1 confezione da 20 cerotti di varie misure
- 1 rotolo di cerotto alto h 2,5 x 5 m
- 1 rotolo di benda orlata h cm 10 x 5 m
- 1 paio di forbici
- 1 laccio emostatico
- 1 confezione di ghiaccio pronto uso
- 1 sacchetto per la raccolta di rifiuti sanitari
- Istruzioni sul modo di usare i presidi suddetti e di prestare i primi soccorsi in attesa del servizio di emergenza



Valigette ALLEGATO 3

Per aziende dei gruppi A e B con 3 o più lavoratori. Contenuto conforme all'Allegato 3 cat. AB DPP 25/2005 Alto Adige.

ALLEGATO 3
VALIDO SOLO PER
LA REGIONE DEL
TRENTINO ALTO
ADIGE.



1 VALIGETTA IN ABS

Valigetta in ABS con supporto a muro, maniglia per il trasporto, chiusura a clip.
BRV0662 - in ABS colore verde, dimensioni cm 41 x 31 x 11 h

CONTENUTO BRV0662

- 5 guanti sterili monouso
- 1 visiera paraschizzi
- 1000 ml di soluzione cutanea di iodopovidone al 10% di iodio
- 1500 ml di soluzione fisiologica (sodio cloruro - 0,9%)
- 10 compresse di garza sterile 10 x 20
- 2 compresse di garza sterile 18 x 40
- 2 teli sterili monouso cm 40x60
- 1 confezione di rete elastica di misura media
- 1 confezione cotone idrofilo
- 3 laccio emostatico in lattice
- 2 pinzetta monouso sterile
- 2 confezioni cerotti varie misure pz. 10
- 2 rotoli di cerotto alto cm. 2,5
- 1 paio di forbici
- 2 ghiaccio pronto uso
- 2 sacchetti monouso per la raccolta di rifiuti sanitari
- 1 termometro digitale
- 1 apparecchio per la misurazione della pressione con fonendoscopio
- 3 tampobenda cm 8 x 10
- 3 tampobenda cm 10 x 12
- 3 benda soft elastica m 4 x cm 8
- 3 benda di garza m 3,5 x cm 10
- 1 coperta isoterma oro-argento
- 1 dispositivo di protezione per la ventilazione artificiale
- 1 disinfettante flacone ml 250
- 1 manuale di pronto soccorso multilingue

2 VALIGETTA IN POLIPROPILENE

Valigetta in polipropilene con supporto a muro, maniglia, chiusura a clip.
BRV0663 - in polipropilene colore arancio, dimensioni cm 32 x 23 x 9 h

CONTENUTO BRV0663

- 2 guanti sterili monouso
- 125 ml di soluzione cutanea di iodopovidone al 10% di iodio
- 250 ml di soluzione fisiologica (sodio cloruro 0,9%)
- 1 compressa di garza sterile cm 18 x 40 in buste singole
- 3 compresse di garza sterile cm 20 x 20 in buste singole
- 1 confezione di cerotti di varie misure pronti all'uso pz. 20
- 1 rotolo di cerotto alto cm 2,5
- 1 confezione cotone idrofilo
- 1 laccio emostatico in lattice
- 1 pinzetta monouso sterile
- 1 paio di forbici
- 1 confezione di ghiaccio pronto uso
- 1 sacchetto monouso per la raccolta di rifiuti sanitari
- 2 tampobenda cm 8 x 10 DIN 13151 M - misura 8
- 2 tampobenda cm 10 x 12 DIN 13151 G misura 10
- 2 bende garza soft m 4 x cm 8 - misura 8
- 2 bende di garza m 5 x cm 10 - misura 10
- 1 coperta isoterma oro-argento
- 1 dispositivo di protezione per la ventilazione artificiale
- 1 manuale di pronto soccorso multilingue



3 PACCHI DI REINTEGRO PER ALLEGATO 3

BRP961 - pacco di reintegro per tutti i kit di pronto soccorso appartenenti alla categoria A e B dell'Allegato 3. Imballo di cartone.

BRP861 - pacco di reintegro per tutti i kit di pronto soccorso appartenenti alla categoria C dell'Allegato 3. Imballo di cartone.



VALIGETTE VUOTE IN ABS

Valigette in ABS in due diverse dimensioni e colori, fornite vuote.

4 BRV201V - valigetta colore arancio, dimensioni 31 x 21 x 12 h

5 BRV102V - valigetta colore verde, dimensioni 42 x 31 x 15 h



VALIGETTE E BORSE PORTATILI DI MEDICAZIONE

1 BORSA IN NYLON ALLEGATO 1

Borsa in resistente nylon colore blu, con scomparti interni, doppia cerniera e tracolla. Contenuto: presidi medici prescritti dall'Allegato 1 D.M. n. 388.

BAG0963 - borsa, dimensioni cm 41 x 31 x 11 h

Contenuto:

- 5 paia di guanti sterili monouso
- 1 visiera paraschizzi
- 1 litro iodopovidone al 10%
- 1500 ml di soluzione fisiologica
- 10 compresse di garza sterile 10x20
- 2 compresse di garza sterile 18x40
- 2 teli monouso cm 40x60
- 2 pinzette da medicazione sterili
- 1 confezione di rete elastica misura media
- cotone idrofilo
- 2 confezioni di cerotti misure varie
- 2 rotoli di cerotto h cm 2,5
- 1 paio di forbici
- 3 lacci emostatici
- 2 confezioni di ghiaccio pronto uso
- 2 sacchetti raccolta di rifiuti sanitari
- 1 termometro clinico digitale
- 1 apparecchio per la misurazione della pressione arteriosa
- istruzioni d'uso



2 VALIGETTA IN PLASTICA

In polipropilene con maniglia per trasporto. Per ferite di piccole entità, utile complemento per autovetture e nelle attività del tempo libero e nel fai da te, campeggio, ecc.

BRV301 - valigetta, dimensioni cm 23 x 17 x 4,3 h

Contenuto:

- 1 benda garza m 2 x cm 5
- 1 cerotto medicato cm 10 x 2
- 10 cerotti adesivi cm 7 x 2
- 1 cotone idrofilo g 5
- 3 fazzoletti disinfettanti
- 1 paio di forbici
- 25 garze sterili cm 10 x 10
- 1 paio di guanti sterili monouso
- 1 laccio emostatico
- 1 pacchetto fazzoletti di carta
- 1 rochetto cerotto m 2 x cm 1
- 1 foglietto illustrativo



3 VALIGETTA IN PLASTICA

Ideale per un primo soccorso per ferite di piccole entità, utile complemento per autovetture private, nelle attività del tempo libero e nel fai da te, campeggio, ecc.

BRV307 - valigetta, dimensioni cm 25 x 16,5 x 7 h

Contenuto:

- 2 bende garza m 2 x cm 5
- 10 cerotti adesivi cm 7 x 2
- 1 cotone idrofilo g 50
- 3 fazzoletti disinfettanti
- 1 paio di forbici
- 25 garze sterili cm 10 x 10
- 1 paio guanti monouso
- 1 laccio emostatico
- 1 pacchetto fazzoletti
- 1 pinzetta polipropilene
- 1 rochetto cerotto m 2 x cm 1
- 1 foglietto illustrativo



4 BORSA IN NYLON

Borsetta in nylon con zip, colore rosso. Ideale per ferite di piccola entità: utile complemento per autovetture private, nelle attività del tempo libero, nel fai da te, ecc.

BRA401 - borsa rossa in nylon, 150 x 130 x 50 mm

Contenuto:

- 1 paio di guanti sterili
- 1 benda elasticizzata m 4 x 6 cm
- 2 bustine sapone liquido 5 ml
- 3 salviette disinfettanti
- 1 pinzetta
- 1 paio di forbici
- 1 rochetto cerotto adesivo tela
- 1 pacchetto fazzoletti
- 10 cerotti medi cm 7 x 2
- 2 buste di garza sterile
- 1 laccio emostatico
- Istruzioni pronto soccorso

5 BORSA IN NYLON

Contenuto conforme a quanto previsto dalla norma DIN 13164 B.

BRA403 - borsa morbida in nylon, 240 x 170 x 80 mm

Contenuto:

- 1 telo sterile antiustioni cm 40 x 60
- 1 telo sterile antiustioni cm 60 x 80
- 2 teli triangolari
- 4 guanti in vinile
- 1 confezione cerotti 14 pezzi
- 1 coperta isoterma
- 1 paio di forbici lister cm 14
- 1 cerotto rochetto m 5 x 2,5 cm
- 4 tampobenda misure varie
- 6 compresse di garza 10 x 10 cm
- 2 bende elastiche 400 x 8 cm
- 3 bende elastiche 400 x 8 cm
- 2 salviette disinfettanti
- 1 manuale di pronto soccorso
- 1 elenco contenuti multilingua



ARMADIETTI VUOTI IN METALLO

Armadietti in acciaio verniciato, serratura metallica con chiave.

6 BRA104V - dimensioni cm 32 x 19 x 45 h

7 BRA103V - dimensioni cm 32 x 12 x 50 h

Contenuto:

- 2 paia di guanti sterili
- 8 fasciature adesive cm 10x6
- 1 flacone acqua ossigenata ml 250
- 5 fazzoletti ammoniaci
- 2 bende elastiche cm 10xm 4
- 2 bende elastiche cm 7,5xm 4
- 2 rochetti cerotto m 5xcm 2,5
- 1 paio di forbici tagliabendaggi
- 1 flacone di disinfettante ml 280
- 125 compresse sterili cm 10x10
- 6 garze idrofile sterili cm 18x40
- 2 teli sterili per ustioni cm 40x60
- cotone idrofilo
- 3 teli triangolari
- 1 coperta isoterma
- 2 bende di garza m 5xm 7
- 2 tampobende sterili cm 8x10
- 2 tampobende sterili cm 10x12
- 1 soluzione salina sterile ml 500
- 1 confezione da 20 cerotti assortiti
- 5 confezioni ghiaccio istantaneo
- 2 ghiaccio spray ml 400
- 3 confezioni rete tubolare elastica
- 1 laccio emostatico
- 2 rianimatori bocca a bocca
- 2 stecche per fratture
- 1 pinzetta sterile
- 1 manuale di pronto soccorso

8 BORSA IN NYLON EMERGENCY

Borsa in nylon ad alta resistenza, impermeabile, chiusura zip, cintura regolabile, tasca centrale più tasche laterali. I prodotti contenuti forniscono un primo ed efficace soccorso. Ideale per le attività all'aperto in caso di medicazione e rianimazione.

BRA404 - borsa in nylon cm 50 x 23 x 23 h





1 STAZIONE LAVAGGIO OCULARE

Contenitore pensile a parete per un'efficace primo lavaggio oculare d'emergenza. In materiale termoplastico, viene fornito corredato di viti con tasselli. La confezione contiene uno specchio e due flaconi di soluzione salina sterile da 500 ml.

BRV304 - stazione, dimensioni cm 25 x 15 x 8



2 KIT LAVAOCCHI

Valigetta verde in polipropilene con supporto per attacco a parete o su automezzi.

Contenuto: 1 flacone vuoto per lavaggio oculare; 1 flacone da ml 500 contenente soluzione salina sterile per lavaggio oculare (Medical Device 93/42/CEE CE 0473); 2 compresse oculari; 2 buste garza idrofila sterile cm 18 x 40; 1 paio di forbici; 1 rotolo cerotto m 1 x 2 cm; 1 pacchetto di fazzoletti; 1 specchio; istruzioni per l'uso

BRV305 - valigetta, dimensioni cm 32 x 23 x 9 h



KIT LAVAOCCHI

Stazione a parete con specchio (viti per fissaggio incluse). Contiene fino a 3 flaconi di soluzione salina da 500 ml per lavaggio oculare.

3 SBV23 - stazione a parete fornita vuota, dimensioni mm 240 x 130 x 230 h

4 CSC041 - soluzione salina sterile con tappo, flacone da 500 ml



KIT LEVASCHEGGE

Valigetta in polipropilene con l'occorrente per togliere schegge, dimensioni cm 23 x 17 x 4,5 h.

Contenuto: 1 lente d'ingrandimento; 1 pinzetta inox levaschegge; 1 matita magnetica; 2 buste garza sterile cm 18 x 40; 1 flacone soluzione sterile salina ml 100; 1 specchio

5 BRV306 - valigetta kit levaschegge

6 BRC103 - matita levaschegge con astuccio



7 KIT USTIONI

Valigetta in polipropilene con supporto.

Contenuto: 3 preparato antiustione 3,5 g; 1 compressa antiustione 10 x 10 cm; 1 paio di forbici lister 14,5 cm DIN; 1 soluzione sterile lavaggio oculare 500 ml; 2 pinze sterili monouso; 1 cerotto in rochetto m 5 x 2,5 cm; 2 telo sterile TNT 40 x 60 cm; 2 benda con tampone antiaderente 100 x 120 mm; 1 telo triangolare TNT; 2 compresse oculari adesive sterili; 1 medicazione antiaderente 10 x 8 cm; 2 confezione da 25 compresse sterili 10 x 10 cm; 2 paia di guanti sterili latex free; 1 elenco contenuto; 1 manuale pronto soccorso multilingua

BRV303 - dimensioni mm 250 x 190 x 85



9 RIANIMATORE BETA

Rianimatore manuale di primo intervento per prima rianimazione, completo di borsa in nylon con tracolla. Idoneo per studi dentistici, centri sportivi, aziende industriali, mezzi di soccorso, ecc.

Contenuto: 1 pallone di rianimazione; 1 apribocca elicoidale; 2 maschere oronasali; 1 pinza laringea in policarbonato; 3 cannule di gudel sterili; istruzioni di pronto soccorso

BRA402 - rianimatore, dimensioni cm 40 x 17 x 24 h



10 VALIGIE EXTRA STRONG VUOTE

Valigia in resina 100% riciclabile, chiusura ermetica stagna certificata IP67 per garantire la resistenza all'acqua e alle polveri. Il campo di applicazione spazia dalla nautica, fotografia, subacquea, caccia, pesca, corpi speciali, industria manifatturiera in generale e tutti quei settori dove è richiesta un'eccellente resistenza agli urti e agli agenti atmosferici.

BRV001V - valigia plastica antiurto, mm 465 x 365 x 175. Fornita vuota

BRV002V - valigia plastica antiurto, mm 550 x 430 x 210. Fornita vuota



CEROTTI

Cerotti classici per la prima medicazione di ferite ed escoriazioni. Supporto in polietilene elastico e micro perforato strato di garza antiaderente per favorire la traspirazione della pelle.

- 1 **BRC104** - confezione da 100 cerotti assortiti, 6 misure
- 2 **BRC105** - confezione da 100 cerotti dimensioni cm 2 x 7
- 3 **BRC106** - confezione da 20 cerotti assortiti, 4 misure
- 4 **BRC107** - rotolo di cerotto in TNT ipoallergenico h cm 2,5 x 5 m



5 CEROTTI EXTRA LUNGI

Cerotti extra lunghi colore pelle. Grazie alla loro lunghezza si avvolgono intorno alle dita mantenendo protetto il taglio o l'abrasione senza problemi di distacchi accidentali come accade con i comuni cerotti standard. Disponibili anche in versione "Detectable" colore blu.

CPS032 - confezione da 100 cerotti extra lunghi color pelle, dimensioni 180 x 20 mm



DISPENSER QUICK FIX PER ESTRAZIONE RAPIDA CEROTTI

Dispenser da parete per cerotti (tasselli e viti compresi). Con l'estrazione, la bustina si apre ed il cerotto è pronto per un immediata applicazione. Il sistema previene furti e sprechi. Fornito vuoto con ricarica a parte, può essere utilizzato con vari formati e modelli di cerotti sia standard in tessuto che "Detectable" colore blu.

- 6 **BRV309** - dispenser in ABS vuoto, dimensioni: cm 23 x 13
- 7 **BRC130** - 1 ricarica da 45 cerotti tessuto cm 7 x 2
- 8 **BRC131** - 1 ricarica da 45 cerotti tessuto cm 7 x 2 Blu Detectable
- 9 **BRC132** - 1 ricarica da 45 cerotti tessuto cm 7 x 2 Water Resistant



CEROTTI BLU "DETECTABLE" PER INDUSTRIE ALIMENTARI

Cerotti ipoallergenici in polietilene da 70 micron colore blu, adesivi, conformabili e morbidi. Ipoallergenici, non contengono lattice e PVC. La striscia sottile in alluminio li rende visibili al metal detector. Ideali per HACCP.

- 10 **BRC133** - confezione da 100 cerotti "Detectable", dimensioni 70 x 20 mm
- 11 **CPS143** - confezione da 50 cerotti "Detectable" extra lunghi, dimensioni 180 x 20 mm



SOLUZIONE SALINA STERILE CON TAPPO PER LAVAGGIO OCULARE

Soluzione monouso pronta all'uso. Per l'utilizzo basta applicare il tappo sopra il flacone e girarlo in senso orario. Ideale come ricambio per le stazioni di lavaggio oculare.

- 12 **BRC126** - flacone da 500 ml di soluzione salina sterile
- 13 **BRC127** - flacone da 250 ml di soluzione salina sterile



DISINFETTANTE IODOPOVIDONE

Disinfettante Iodopovidone al 10% di iodio fornito in due formati.

- 14 **BRC128** - flacone da 125 ml di disinfettante Iodopovidone
- 15 **BRC129** - flacone da 500 ml di disinfettante Iodopovidone



16 TERMOMETRO CLINICO DIGITALE

Termometro elettronico con segnale acustico e display a cristalli liquidi. Avviso acustico a fine misurazione. Auto spegnimento.

BRC124 - termometro clinico digitale con astuccio in plastica



1

1 COTONE IDROFILO

Soffice ovatta di puro cotone idrofilo (100 % cotone) in miscela tipo INDIA EXTRA, ottenuta da diversi tipi di cotone idrofilo pregiato, candeggiati con acqua ossigenata. Biocompatibile e microbiologicamente testato.

BRC111 - confezione di cotone idrofilo



2

2 GHIACCIO INSTANTANEO

Busta di ghiaccio istantaneo utile in caso di traumi o piccole emorragie. Mantiene fredda la parte lesa per circa 15 minuti.

BRC123 - ghiaccio istantaneo pronto all'uso, peso 300 g



3

3 PINZETTA STERILE

Utilizzata per effettuare medicazioni (afferrare garze o cotone o similari), indicata anche per la rimozione di piccoli corpi estranei e per operazioni con materiale sterile. Altezza 80 mm.

BRC113 - pinzetta sterile monouso



4

4 GUANTI R76 IIIA CATEGORIA



Guanti in nitrile senza polvere, monouso, ambidestri. 100% Latex Free. Taglie (EN): dalla XS alla XL. Confezione dispenser da 100 pezzi. Minimo ordinabile 1 dispenser/multipli.

GER076/. - lunghezza mm 240



NEW

5

5 BENDA COESIVA

Ideale per coprire ferite specialmente nei punti critici (es. dita delle mani). Modellabile, autoaderente, elastica, resistente all'acqua e privo di lattice. Si usa direttamente sulla ferita: assorbe il sangue e non si attacca alla pelle e ai peli.

CPS063 - benda coesiva color pelle, dimensioni 6 x 450 cm



NEW

6

6 TAMPOBENDA

Tampobenda assorbente per emorragie con benda elastica e fermabenda. Materiale: PE bassa densità e TNT.

CPS239 - tampobenda assorbente per emorragie, dimensioni 120 x 55 mm



7

7 FORBICI TAGLIABENDAGGI

Forbivi tagliabendaggi con manico in plastica, tipo Lister colore verde. In acciaio inox, con manico in plastica. Altezza 145 mm. Dispositivo conforme alla Dir. MDR 745/2017.

BRC112 - forbici tagliabendaggi



8

AUSILI PER LA MEDICAZIONE VARI

8 BRC114 - telo triangolare in TNT, misure 96 x 96 x 136 cm



9

9 BRC115 - confezione benda tubolare elastica, misura media, estensione 1 m



10

10 BRC116 - 1 compressa di garza sterile cm 10 x 20



11

11 BRC117 - 1 compressa di garza sterile cm 18 x 40



12

12 BRC118 - 1 benda garza orlata m 3,5 x 10 cm



13

13 BRC121 - laccio emostatico piatto in nitrile cm 46



14

14 BRC125 - confezione da 8 salviette (3 disinfettanti, 2 ammoniacca, 3 sapone)



15

15 SACCHETTI PER RIFIUTI SANITARI

Sacchetti con stampa "R" rifiuti, colore bianco, dimensioni cm 20 x 30.

BRC109 - confezione da 100 sacchetti per rifiuti sanitari



16

16 MASCHERINA CON VISIERA PARASCHIZZI

Mascherina chirurgica in TNT a tre strati di colore verde con visiera in PVC che protegge da spruzzi e schizzi. Con elastici e stringinaso conformabile. I tre strati di tessuto garantiscono la massima protezione da agenti esterni.

BRC120 - mascherina con visiera



1 SFIGMOMANOMETRO DA POLSO

Compatto, facile da usare e trasportare ovunque. Il grande display (2,5") di facile lettura visualizza contemporaneamente la misurazione rapida e precisa della pressione sistolica, diastolica, della frequenza del battito, data/ora e il rilevamento del battito irregolare IHD (Aritmia). Metodo di misurazione oscillometrica.

BRC119 - sfigmomanometro da polso digitale



2 SFIGMOMANOMETRO

Con manometro in lega leggera. Tolleranza +/-3 mm/Hg. Completo di bracciale adulto in cotone con chiusura velcro e anello in metallo, fornito in custodia in similpelle con cerniera.

BRC110 - sfigmomanometro ad aneroido con fonendoscopio (misuratore di pressione)



3 PALLONE PER RIANIMAZIONE

Da utilizzarsi in caso di emergenza sia come manovra nella rianimazione che per supportare l'attività respiratoria nei pazienti in cui la ventilazione polmonare è insufficiente. Consigliato per essere impiegato collegato all'ossigeno in caso vi sia la necessità di massimizzare l'ossigenazione del paziente. Pallone di rianimazione in PVC, dotato di valvola sovrappressione, tubo ossigeno e reservoir. Smontabile e disinfettabile a freddo con soluzioni battericide non corrosive.

CPS29 - pallone per rianimazione adulto, volume 1630 ml, reservoir 2000 ml



4 APRIBOCCA ELICOIDALE + RIANIMATORE

Strumento necessario per procedere all'apertura forzata della bocca in caso di serramento della mandibola del paziente. Apribocca elicoidale in nylon con pratica impugnatura che ne permette una presa sicura, dotata di scomparto per l'inserimento del rianimatore bocca a bocca CPS025. Scadenza prodotto: 5 anni dalla data di produzione (se il prodotto viene conservato adeguatamente).

CPS100K - apribocca elicoidale + rianimatore bocca a bocca monouso



5 POCKET MASK

Maschera con bordo pneumatico per la rianimazione bocca a bocca. Indicata per la rianimazione cardiopolmonare, è un dispositivo fondamentale per ripristinare la respirazione in caso di arresto respiratorio o cardiaco. Dotata di valvola unidirezionale e attacco per connessione ossigeno. Fornita con custodia in polipropilene.

CMAS001 - maschera per la rianimazione bocca a bocca



6 RIANIMATORE BOCCA A BOCCA

Rianimatore bocca bocca monouso (imbustato in sacchetto di polietilene) con boccaglio e valvola unidirezionale in policarbonato, schermo protettivo in PVC atossico che evita ogni contagio tra paziente e soccorritore. Date le sue ridotte dimensioni, è un utile accessorio in ogni kit di pronto soccorso. Fornito con istruzioni in 4 lingue (italiano, inglese, tedesco, francese).

CPS025 - rianimatore bocca a bocca monouso



1 FORBICI MULTIUSO

Ideali in caso di emergenza per: rompere cristalli, tagliare vestiti, cinture di sicurezza e oggetti spessi (coltello). Autoclavabile, fornita con fodero e accessori per il fissaggio a parete.

CPS299 - forbici multiuso in acciaio inox, lunghezza 233 mm



2 PINZA PER SIRINGHE

Pinza prensile multiuso, ideale per raccogliere piccoli oggetti come siringhe. Comoda impugnatura, leggera, con presa decisa evita qualsiasi contatto diretto con rifiuti pericolosi.

BRC101 - pinza di raccolta cm 100 x 12, peso gr 140

3 CONTENITORE PER SIRINGHE E AGHI USATI

Contenitore privo di cloro, piombo e cadmio. Chiusura sicura, con tenuta garantita anche in caso di caduta. Coperchio con 3 dispositivi per lo sgancio dei vari tipi di aghi e cannule. Capacità lt 3,5.

BRC100 - contenitore per rifiuti pericolosi, dimensioni mm 158 x 158 x 185 h

4 CONTENITORE RIFIUTI SANITARI PERICOLOSI

Cartone con sacco interno in polietilene per rifiuti pericolosi, mini-ordinabile: 60 pezzi/multipli.

BON269 - contenitore monouso in cartone, dimensioni mm 368 x 268 x 533 h



5 COPERTA ISOTERMICA IN ALLUMINIO DORATO

Coperta isoterica d'emergenza in film poliestere con copertura in alluminio/alluminio dorato. Ha la funzione di isolare termicamente l'infortunato in funzione del lato utilizzato: argento protegge dal caldo, dorato protegge dal freddo. Il telo riflette e trattiene oltre l'80% del calore emanato dal corpo permettendo così di mantenere calda una persona persino a temperature rigide.

BRB103 - coperta isoterica, dimensioni cm 160 x 220



GRAZIE ALLE SUE 10 MANIGLIE, PERMETTE DI TRASPORTARE L'INFORTUNATO IN MODO AGEVOLE E SICURO.

6 TELO PORTAFERITI A NORMA EN 1865

Telo in materiale sintetico, permette un trasporto sicuro dell'infortunato. Munito di 10 maniglie per il trasporto, antiputrescente, ininfiammabile, anticido e permeabile ai raggi X. Portata massima 150 kg.

BRB104 - telo portafertiti in tessuto spalmato PVC, dimensioni cm 190 x 53, peso 2 kg



7 SEDIA PORTANTINA

Sedia per trasporto pazienti in posti disagiati (scale, corridoi, ascensori) e dove non passa la barella. Quattro maniglie di cui due frontali regolabili in lunghezza. Struttura in alluminio anodizzato leggero con telo termoplastico impermeabile. Bloccaggio di sicurezza automatico. 3 cinture a sgancio rapido, 2 ruote fisse. Portata kg 159.

BRB108 - sedia portantina, dimensioni cm 91 h x 51 x 120 (manici aperti) e cm 91 h x 51 x 86 (manici chiusi), peso kg 8,5



BARELLE E FERMACAPO



1 BARELLA PIEGHEVOLE

Struttura solida e leggera in alluminio anticorrosione e anodizzato. Piedini di sostegno in alluminio protetti da gomma antiscivolo. Telo in resistente nylon arancio rivestito in vinile impermeabile, antiputrescente, autoestinguente e lavabile. La barella può essere ripiegata in 4 parti per facilitarne il trasporto. Borsa di trasporto inclusa. Peso kg 5, portata kg 159.

BRB109 - barella pieghevole. Dimensioni: aperta cm 221 x 53 x 15, chiusa cm 110 x 18 x 11

BRB109C - cinghie di bloccaggio fornite con custodia

2 BARELLA SPINALE RX

La barella rigida spinale permette di trasportare e immobilizzare il paziente con sospetta lesione della colonna vertebrale. Permette di mantenere la posizione neutrale fisiologica della colonna vertebrale, superiore alla tradizionale barella a "cucchiaio", la quale può comunque essere impiegata per posizionare il paziente sulla barella. Stampata in un unico pezzo in polietilene ad alta densità, che gli conferisce rigidità, leggerezza e resistenza agli urti e alla corrosione. Impermeabile, completamente radiotrasparente, lavabile.

BRB110 - barella in polietilene, dimensioni: cm 184 x 45 x 5, peso kg 7, portata kg 159

BRB110C - cintura a ragno di bloccaggio

3 CINGHE DI IMMOBILIZZAZIONE

Set di 3 cinghie per immobilizzare il paziente, idoneo per tutte le barelle e tavole spinali.

CPS235 - set 3 cinghie di immobilizzazione

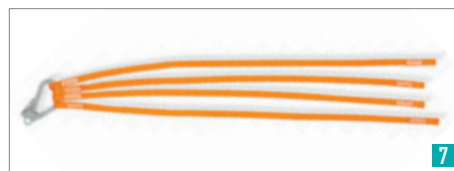

BARELLA ATRAUMATICA

Grazie all'azione delle due lame longitudinali è possibile sistemare la barella sotto il paziente senza doverlo muovere. Robusta struttura in lega di alluminio anodizzato, regolabile in lunghezza, con 3 cinture ad innesto rapido. Peso kg 8. Dimensioni: lunghezza massima cm 214, minima cm 167, larghezza cm 44, dimensioni chiusa cm 120 x 44 x 9,5. Portata massima kg 159.

4 BRB101 - barella atraumatica in alluminio

5 BRB101B - borsa custodia in nylon per BRB101

BARELLA BASKET

Ideale per il soccorso in miniera, in quota, in acqua. Guscio in polietilene ad alta densità solidarizzato a un telaio in alluminio, completa di materasso in poliuretano espanso ad alta densità trattato con spalmatura impermeabile all'acqua e al sangue. Fornita con cima in nylon lungo tutto il perimetro, 3 cinture da 50 mm in nylon a innesto rapido, poggipiedi in polietilene con regolazione del posizionamento. Fornibile a parte l'imbracatura per il trasporto con elicottero. Peso kg 14, portata kg 280.

6 BRB105 - barella, dimensioni cm 217 x 62 x 18,5

7 BRB105A - imbracatura per trasporto barella Basket con elicottero



8 BARELLA PER SPAZI CONFINATI

Barella in PE con maniglie in nylon per soccorsi in ambienti confinati e difficoltosi. Ideale per il trasporto del paziente in situazioni difficili, dove è richiesto un recupero rapido. La barella è inerte a tutte le condizioni ambientali e fluidi corporei e può essere lavata senza che vengano assorbiti liquidi organici o biologici. Compatta e leggera, facile da usare e predisporre (l'utilizzo di cinghie, fettucce e fibbie di colori differenti previene errori nel montaggio), permette un sostegno ottimale del paziente. Carico massimo: 150 kg.

CPS010 - barella per spazi confinati, dimensioni 2450 x 920 mm, peso kg 7,3

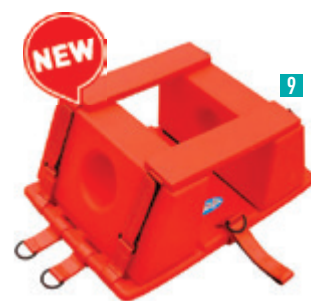

9 FERMACAPO PER BARELLE

In schiuma ad alta densità con rivestimento idrorepellente, permette un veloce e sicuro bloccaggio del capo del traumatizzato. Per tutte le barelle atraumatiche e spinali.

PSC001 - fermacapo, dimensioni 430 x 260 x 160 mm, peso kg 1



1



1 DEFIBRILLATORE SEMIAUTOMATICO HEARTSINE 350P

La confezione contiene:

- 1 defibrillatore HeartSine 350P
- 1 Pad-Pak (batteria + elettrodi) per adulti
- 1 borsa soft da trasporto (giallo-blu)
- 1 manuale d'uso (cartaceo)

Il software Saver EVO è scaricabile gratuitamente dal sito del produttore.

DEF350P - defibrillatore semiautomatico mm 234 x 184 x 48, peso kg 1,1

CARATTERISTICHE

- **Dimensioni e peso ridotti:** è il più piccolo e leggero (1,1 kg batteria inclusa) defibrillatore automatico disponibile sul mercato.
- **Facilità di utilizzo:** il defibrillatore è dotato di soli due pulsanti: "On/Off" e "Scarica".
- **Onda bifasica SCOPE®:** tecnologia esclusiva brevettata che modula l'energia erogata in base all'impedenza del paziente. L'impedenza è una grandezza che misura la resistenza elettrica: in base all'impedenza, il defibrillatore "adatta" l'intensità della scarica elettrica sul paziente. La misurazione dell'impedenza serve al dispositivo per "capire" se gli elettrodi sono stati posizionati correttamente sul torace del paziente. Nel caso in cui l'impedenza del paziente non dovesse essere corretta, il defibrillatore, anziché proseguire con l'erogazione della scarica elettrica, continuerebbe a ripetere di posizionare gli elettrodi sul torace della vittima.
- **Indice di protezione IP56:** la maggior parte dei DAE in commercio possiede indice di protezione IP54 o IP55. Il defibrillatore HeartSine 350P ha indice di protezione IP56, ossia possiede un involucro che li protegge da polvere e forti getti d'acqua, compresa l'acqua di mare.
- **Garanzia di 8 anni:** la più longeva sul mercato tra i defibrillatori DAE.
- **RCP Coaching:** il defibrillatore HeartSine 350P è provvisto di metronomo integrato che scandisce la frequenza alla quale effettuare le compressioni toraciche durante le manovre di rianimazione cardiopolmonare.
- **Cartuccia con elettrodi e batteria.** 2 versioni: una cartuccia per adulti e bambini con più di 8 anni d'età e/o sopra i 25 kg di peso; una cartuccia pediatrica per bambini con un peso inferiore ai 25 kg.
- **Funzione pediatrica:** il defibrillatore HeartSine 350P riconosce da sé l'energia di scarica da applicare in base alla tipologia di cartuccia inserita nel dispositivo. Codice accessorio da comprare a parte.
- **Aggiornamento software:** il dispositivo può essere aggiornato tramite cavetto USB e software gratuito Saver EVO scaricabile direttamente dal sito del produttore.
- **Registrazione degli eventi:** ogni volta che il defibrillatore viene utilizzato, il dispositivo registra data ed ora dell'intervento, ECG, intervalli di RCP (Rianimazione Cardio-Polmonare) e parametri di erogazione della scarica. Tutte queste informazioni sono scaricabili sul proprio PC mediante l'utilizzo dell'apposito software gratuito.
- **Self-test automatico settimanale:** segnala mediante un led pulsante se il dispositivo necessita di assistenza o se è perfettamente funzionante.

2



ARMADIO IN METALLO PER DEFIBRILLATORE

Realizzato in lamiera di acciaio al carbonio P02 zincato colore bianco. 1 anta finestrata, cerniere con perno zincato, chiusura a sigillo lucchettabile in zama nichelata. Preforata, per attacco a parete e su apposita piantana CPS040P. Disponibile versione con allarme sonoro fisso 100 db magnetico, con sistema di inserimento e disinserimento tramite comando con tastiera, installato all'interno dell'armadietto. Dimensioni mm 425 x 425 x 180 mm, peso 6,8 kg.

2 CPS040 - armadio per defibrillatore

CPS040A - armadio per defibrillatore con allarme

3 CPS040P - piantana per armadio

NEW



3

4



4 TECA PER DEFIBRILLATORE

Teca altamente robusta e durevole che garantisce una protezione ottimale del defibrillatore. Con allarme che si attiva in caso di apertura non autorizzata della teca: l'allarme ha un volume regolabile da 84 a 98 dB, un pulsante per essere messo temporaneamente in pausa ed è alimentato da due batterie AA (include). A richiesta fornibile teca riscaldata. Dimensioni 480 x 480 x 180 mm, peso 1,8 kg.

CPS047 - teca per defibrillatore con allarme



Prodotti e kit antiustione integrazione ottimale per cassette di Pronto Soccorso

Burnshield® è un **Dispositivo Medico Antiustione** CE 0473 Classe II b, **atto ad essere utilizzato su ustioni di 1°, 2° e 3° grado anche in presenza di derma leso**. Ottiene un raffreddamento immediato ed un'idratazione ottimale che riduce e/o annulla il dolore e l'ustione stessa. **Quanto prima si applica Burnshield® alla zona ustionata, tanto maggiore sarà la riduzione o l'eliminazione dell'ustione**. Per ottenere il massimo risultato, mantenere l'applicazione per almeno 15 minuti dopo la scomparsa del dolore. **Senza alcuna controindicazione sono adatti per abrasioni, ustioni chimiche e da radiazione. Le garze e le coperte antiustione Burnshield®** sono composte da tessuti ultrasottili ed elastici saturati con Idrogel. Non si attaccano mai alle ferite e possono essere rimosse senza dolore. Pronte all'uso sia su singole che su multiple bruciature. Sterili, sono confezionate in buste di polipropilene argentato all'interno.

IN CASO DI USTIONI, SI FIDANO DI BURNSHIELD®:

- MINISTERO DELLA SALUTE: SISTEMA SANITARIO NAZIONALE
- MINISTERO DELLA DIFESA: CROCE ROSSA MILITARE, ARMA DEI CARABINIERI, ESERCITO ITALIANO, MARINA MILITARE, AERONAUTICA MILITARE
- MINISTERO DEGLI INTERNI: POLIZIA DI STATO, VIGILI DEL FUOCO
- MINISTERO DELLA GIUSTIZIA: POLIZIA PENITENZIARIA
- MINISTERO DELL'ECONOMIA E FINANZA: GUARDIA DI FINANZA
- PRESIDENZA DEL CONSIGLIO: PROTEZIONE CIVILE



CONTENUTO KIT PROFESSIONAL

- 2 bustine IDROGEL 3,5 ml
- 2 garze IDROGEL cm 10 x 10
- 1 benda IDROGEL arto/collo cm 100 x 5
- 1 garza IDROGEL cm 20 x 20
- 1 flacone IDROGEL 125 ml spray no gas
- 1 garza IDROGEL cm 60 x 40
- 1 contour IDROGEL cm 100 x 100
- 1 rochetto cerotto ipoallergenico cm 500 x 1,25
- 1 paio di forbici cm 10
- 3 paia di guanti sterili latex free
- 1 pinzetta sterile
- 2 sacche isoterme arto cm 120 x Ø 33
- 2 bende isoterme cm 15 x 200
- 1 coperta isoterma
- 1 opuscolo informativo



CONTENUTO KIT EASY

- 2 garze IDROGEL cm 10 x 10
- 1 garza IDROGEL cm 20 x 20
- 3 bustine IDROGEL 3,5 ml
- 1 rotolo cerotto adesivo cm 1,25 x 50
- 1 paio di guanti sterili latex free
- 1 pinzetta sterile
- 1 paio di forbici cm 10
- 1 opuscolo informativo



CONTENUTO KIT ESSENTIAL

- 1 Burnshield Burngel Tubo 10 ml
- 1 medicazione per dita 2,5 cm x 50 cm
- 3 bustine IDROGEL 3,5 ml
- 2 bende cm 5 x 200
- 8 cerotti impermeabili
- 1 nastro in plastica
- 1 paio di guanti
- 1 opuscolo informativo



1 KIT COPERTA

BUK883 - kit coperta composto da: 1 coperta IDROGEL cotone cm 120 x 160 e 1 coperta isoterma argento/oro cm 210 x 160

PRODOTTI SFUSI

- BUG111** - 1 garza IDROGEL cm 10 x 10
- BUG906** - 1 garza IDROGEL cm 20 x 20
- BUG100** - 1 garza IDROGEL facciale cm 20 x 45
- BUG007** - 1 garza IDROGEL cm 60 x 40
- BUG520** - 1 flacone IDROGEL spray no gas ml 125
- BUG881** - 1 contour IDROGEL cotone cm 100 x 100 (garza in cotone impregnata di IDROGEL)
- BUG901** - 1 benda IDROGEL arto cm 100 x 5

KIT ANTIUSTIONE

- 2 BUK903 - Kit Professional.** Confezione in busta PVC, dimensioni cm 44 x 34
- 3 BUK012 - Kit Easy.** Confezione bauletto PVC rigido, dimensioni cm 24 x 14 x 6
- 4 BUK013 - Kit Essential.** Borsa in nylon con cinghie e gancio, dimensioni cm 18 x 11 x 4



1 LETTINO DA VISITA

Letto da visita con struttura portante in tubo d'acciaio e gambe smontabili. Sistema di sollevamento della testata azionato mediante dispositivo a scorsioio con regolazione autobloccante. Le parti imbottite sono costituite da gommapiuma incollate su supporti in legno truciolare e ricoperte in materiale lavabile autoestingente. Fornito smontato. Peso 28 kg.

CPS124 - lettino in acciaio cromato, dimensioni cm 180 x 55 x 80 h, portata 150 kg

2 LETTINO MEDICO PIEGHEVOLE

Letto medico con uno snodo pieghevole a valigia. Telaio in tubolare quadrato di acciaio cromato. Cuscini imbottiti e rivestiti in tessuto lavabile. Completo di sacca per il trasporto. Portata 130 kg.

CPS268 - lettino pieghevole, dimensioni cm 60 x 90 x 15 (chiuso), cm 180 x 61 x 72 h (aperto), peso 20 kg

3 SGABELLO GIREVOLE

Sgabello elevabile con seduta in acciaio inossidabile. Base in materiale plastico con ruote piroettanti e pistone con regolazione dell'altezza (regolabile 43-55 cm).

CPS112 - sgabello girevole, dimensioni Ø 32 cm

ACCESSORI PER LETTINI

4 CPS119 - portacarta per lettino

5 CPS120 - lenzuolo in carta mt 80 x cm 60. Minimo ordinabile 6 rotoli/multipli

6 CPS122 - predellino ad un gradino



7 ARMADIO VETRINA 4 ANTE

Armadio portastrumenti per ambulatorio medico realizzato in lamiera d'acciaio verniciato. Parte superiore: due porte a cerniera in vetro temperato, serratura con chiave e tre ripiani regolabili in acciaio inox. Parte inferiore: due ante in lamiera verniciata con serratura e 1 piano regolabile in acciaio inox.

CPS121 - armadio vetrina 4 ante con ripiani, dimensioni cm 75 x 38 x 164 h, peso 48 kg

8 ARMADIO VETRINA 1 ANTA

Armadio portastrumenti per ambulatorio medico realizzato in lamiera d'acciaio verniciato. Porta a cerniera in vetro temperato con serratura e chiave: all'interno, tre ripiani regolabili in acciaio inox. Struttura smontabile.

CPS107 - armadio vetrina 1 anta con ripiani, 1, dimensioni cm 53 x 36 x 139 h, peso 30 kg

9 PARAVENTO

Paravento a 3 elementi con ruote, telaio in tubolare di metallo cromato e tre teli plastici lavabili antifiamma di colore bianco. Ripiegabile su se stesso, ogni elemento misura cm 50 di larghezza. Peso con imballo 22 kg.

CPS117 - paravento con ruote a 3 ante, dimensioni cm 150 x 42 x 167 h

10 ATTACCAPANNI

Attaccapanni a colonna verniciato bianco con portaombrelli. Base a 5 razze. Fornito smontato.

CPS060 - attaccapanni con portaombrelli, basamento pesante

DOCCE E LAVAOCCHI DI EMERGENZA: LE NORMATIVE

NORME DI PRIMO SOCCORSO

Il primo soccorso per qualsiasi ustione chimica per l'azione di sostanze acide, caustiche, radioattive o comunque irritanti e contaminanti, consiste nel diluere il prodotto nocivo irrorando la parte del corpo interessata, il più rapidamente possibile, con abbondanti quantità d'acqua corrente: un simile trattamento è in grado, nella quasi totalità dei casi, di limitare dannose conseguenze, mentre anche un ritardo di pochi secondi può risultare fatale. I presidi disponibili per gli interventi di emergenza atti ad allontanare sostanze aggressive o a soffocare incendi degli indumenti, sono costituiti da lavaocchi, docce, complessi docce + lavaocchi e stazioni di decontaminazione. Tutto il personale dovrà essere istruito sull'uso corretto degli equipaggiamenti. Il lavaggio oculare dovrà avere una durata di 10/15 minuti, la doccia una durata di 5/10 minuti.

CRITERI D'INSTALLAZIONE DI DOCCE E LAVAOCCHI

L'installazione delle docce o dei lavaocchi, ove necessaria, deve essere prevista per ciascuna area considerata pericolosa in posizione ben visibile, chiaramente identificabile e raggiungibile in pochi istanti (max. 10") anche da una persona infortunata e priva di aiuto. Si consiglia una distanza massima di 15/20 metri. In caso di possibili incidenti simultanei, prevedere più di una apparecchiatura. Gli equipaggiamenti, docce e lavaocchi, devono essere collegati alla rete dell'acqua potabile installando a monte una valvola d'arresto per la manutenzione.

Lavaocchi: collegare alla rete dell'acqua potabile avente pressione minima di 2 bars con una tubazione minima di 3/4". La portata d'acqua minima dovrà essere di 12 lt/minuto a 2 bars.

Docce e docce + lavaocchi: collegare alla rete d'acqua potabile con una tubazione minima di 1 1/4", ed alla pressione minima di 2 bars. La portata d'acqua minima dovrà essere di 120 lt/minuto per la sola doccia.

STANDARD DI COSTRUZIONE

Le docce ed i lavaocchi di seguito illustrati vengono realizzati completamente in acciaio usando tubazioni zincate a caldo e successivamente ricoperte per immersione di resina Polyamide 11 (RILSAN) color GIALLO, oppure in acciaio INOX AISI 304 che garantisce una maggiore durata anche in atmosfere molto aggressive. Le vaschette dei lavaocchi ed i soffioni delle docce sono in ABS di colore giallo-cromo, oppure in acciaio INOX e le valvole sono in bronzo nichelato o cromato. Le tubazioni flessibili sono tutte provate a 25 bar. Costruzione a norma (a seconda dei modelli): **UNI EN 15154-2:2007**, **UNI EN 15154-1:2007**, **UNI EN 15154-1/2:2007** e **UNI 9608:1993**.

AVVERTENZA IMPORTANTE!

In alcune zone la presenza di acque ricche di calcare può causare inconvenienti su tubazioni e valvole per la formazione di incrostazioni. L'utilizzatore avrà cura, dove accertato l'inconveniente, di provvedere all'installazione a monte, di opportuni filtri decalcificanti. Si dovrà inoltre instaurare una procedura che garantisca un controllo settimanale della perfetta efficienza delle docce e dei lavaocchi.



Caratteristiche tecniche generali

- Docce e lavaocchi certificate a norma CE-DIN 12899 - UNI 9608 - EN 15154.
- Robusta struttura in acciaio zincato e raccordi in ottone
- Verniciatura epossidica anticorrosiva
- Coppe paraocchi in morbida gomma antiallergica con tappo antipolvere, spruzzo aerato e regolato tramite dispositivo integrato (a norma DIN EN 246)
- Testata con ampio getto conico (fino a \varnothing 2 m)
- Maniglia conforme alla normativa DIN
- Pre-assemblaggio di fabbrica
- Tutti i comandi sono collegati a valvole a sfera ispezionabili ed estraibili per una perfetta manutenzione
- Per interni ed esterni
- Per installazioni con condizioni climatiche particolari, dove si rischia il congelamento, si consiglia l'utilizzo di docce e lavaocchi autodrenanti

FORNIBILI ANCHE NEI COLORI VERDE E ROSSO!



DOCETTE SINGOLE O DOPPIE

Installazione a banco o a parete, doccia semplice o doppia. Tubo flessibile in acciaio inox 1,5 m e supporto per fissaggio. Attacco: G3/8" da collegare alla rete idrica. Utilizzare acqua potabile. Pressione minima richiesta: 2 bar. Portata d'acqua: > 12 litri/min (doccetta doppia), > 6 litri/min (doccetta singola).

- LVD19Y** - doccetta singola estraibile
- LVD20Y** - doccetta singola estraibile con supporto a parete
- LVD21Y** - doccetta doppia estraibile
- LVD22Y** - doccetta doppia estraibile con supporto a parete

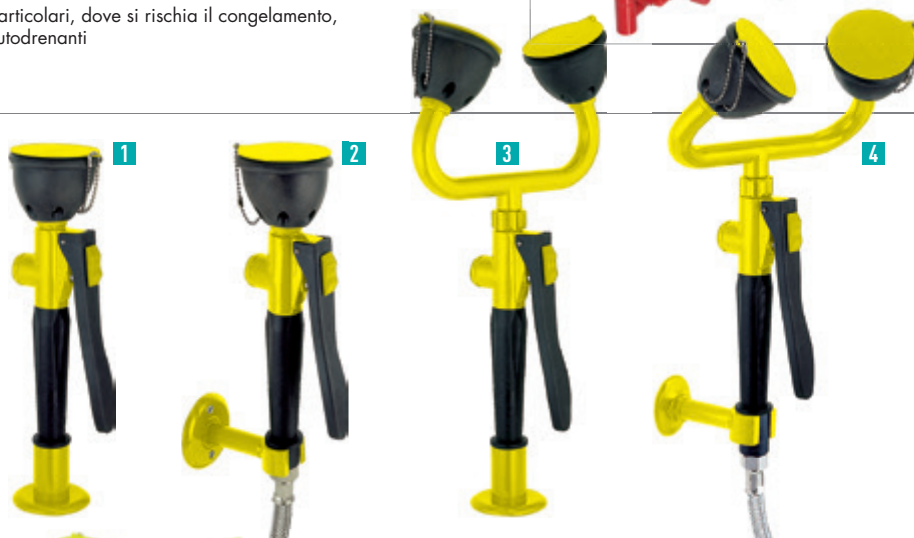

LAVACCHI CON VASCHETTA LVD11Y

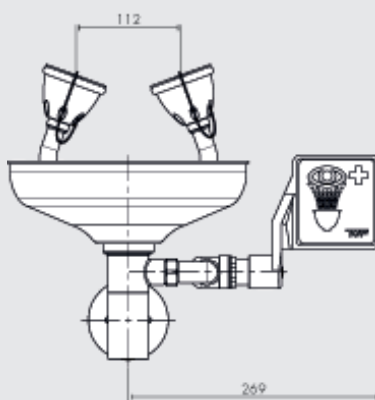

LAVACCHI A PARETE CON VASCHETTA

Installazione a parete. Comando manuale azionabile da leva completa di insegna conforme alla norma. Alimentazione G 1/2": da collegare alla rete idrica. Utilizzare acqua potabile. Scarico: G1". Pressione minima richiesta: 2 bar. Portata d'acqua: > 12 l/min (come da norma).

- LVD11Y** - lavaocchi a parete con vaschetta in ABS
- LVD11XY** - lavaocchi a parete con vaschetta INOX



7 FUSTO PORTATILE CON DOCSETTA D'EMERGENZA

Particolarmente indicato in ambiti ove non è possibile il collegamento alla rete idrica. Doccetta per occhi (DIN 12 899 - UNI 9608); portata acqua secondo normativa, azionamento mediante leva con fermo. Dotata di tubo flessibile inox 1,5 m. Fusto in acciaio inox capacità 18 l di cui 15 l di carico con acqua potabile da pressurizzare con 6 bar di aria. Caricabile con innesto "JOLLY" in dotazione. Dotato di manometro di controllo e valvola di sfogo in caso di sovraccarico.

LVD16Y - fusto portatile con doccetta estraibile



LAVAOCCHI A PAVIMENTO

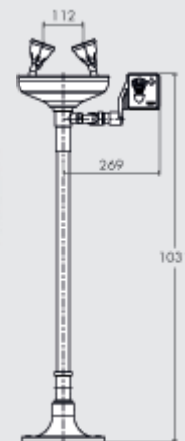

LAVAOCCHI A PAVIMENTO

Installazione a pavimento. Basamento a pedale in alluminio. Vaschetta in ABS. Comando manuale e/o pedale azionanti il lavaocchi. Alimentazione: G $\frac{1}{2}$ " da collegare alla rete idrica. Utilizzare acqua potabile. Scarico: G1". Pressione minima richiesta: 2 bar. Portata d'acqua: > 12 l/min.

- 1 **LVD12Y** - lavaocchi a pavimento
- 2 **LVD13Y** - lavaocchi a pavimento con doppio comando
- 3 **LVD13XY** - lavaocchi a pavimento con doppio comando e vaschetta INOX
- 4 **LVD09Y** - lavaocchi a pavimento con vaschetta e doccetta estraibile

RICAMBI PER DOCCE E LAVAOCCHI

- 5 **LVRIC119Y** - coppa paraocchi singola
- 6 **LVRIC103Y** - kit doppio oculare senza rompigetto e senza coppe
- 7 **LVRIC125** - rompigetto per doccette singole
- LVRIC126** - rompigetto per doccette doppie
- 8 **LVRIC124Y** - testata doccia
- 9 **LVRIC87Y** - kit raccordo 45° per oculare doppio inclinato
- 10 **LVRIC46** - guarnizione per oculare doppio inclinato
- 11 **LVRIC123Y** - valvola da 1" da incasso con leva per LVD14 e LVD15
- LVRIC131Y** - valvola da 3/4" da incasso con leva per LVD17 e LVD18
- LVRIC132Y** - valvola da 1/2" da incasso con leva per LVD11, LVD12 e LVD13
- 12 **LVRIC127Y** - tubo flessibile con schermatura inox
- 13 **LVRIC128Y** - kit supporto dritto da banco
- 14 **LVRIC129Y** - kit supporto 45° da banco/da parete
- 15 **LVRIC130Y** - kit supporto a parete

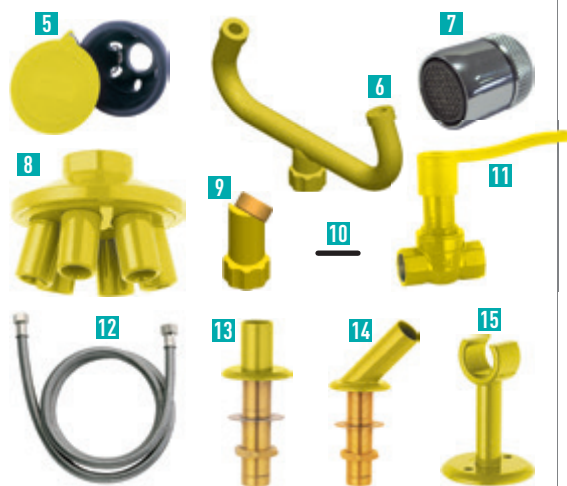

KIT OCULARE DOPPIO COMPLETO

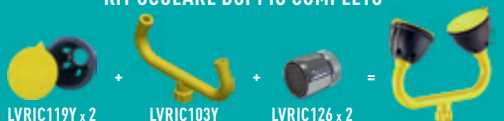

KIT OCULARE DOPPIO INCLINATO COMPLETO

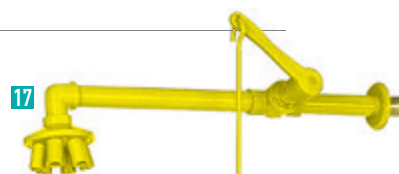

DOCCIA A SOFFITTO

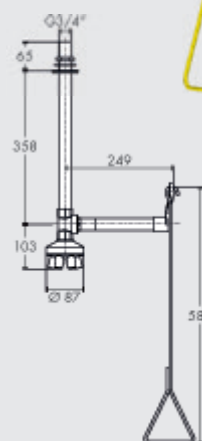

DOCCIA DI EMERGENZA DA PARETE E A SOFFITTO CON VALVOLA

Speciale testata in ottone, getto triangolare elicoidale. Asta comanda manuale azionante la testata. Alimentazione: G1" da collegare alla rete idrica. Utilizzare acqua potabile. Scarico: G1". Pressione minima richiesta: 2 bar. Portata d'acqua: > 60 l/min.

- 16 **LVD18Y** - doccia di emergenza a soffitto
- 17 **LVD17Y** - doccia di emergenza a parete



APPLICABILI AL CODICE FE110

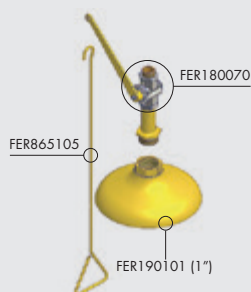

APPLICABILI AI CODICI FE111 - FE111S

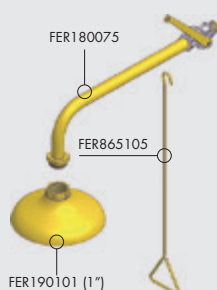

APPLICABILI AL CODICE FE111A

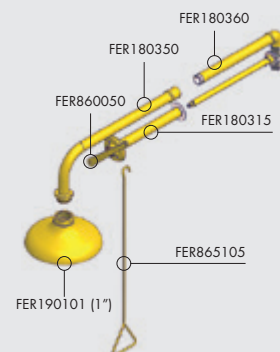

APPLICABILI AL CODICE FE311

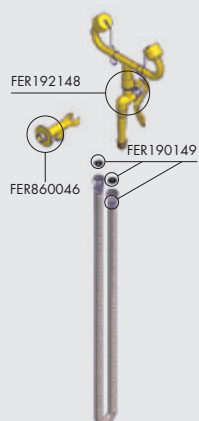

APPLICABILI AL CODICE FE312

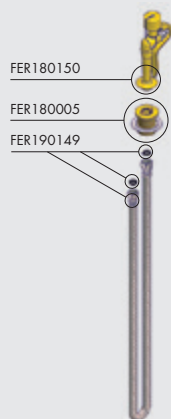

APPLICABILI AL CODICE FE313

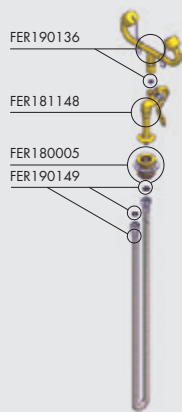

APPLICABILI AL CODICE FE212

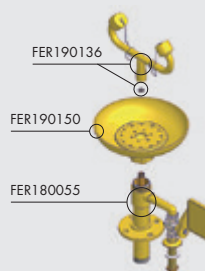

APPLICABILI AI CODICI FE221 - FE221S

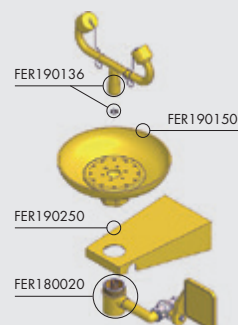

APPLICABILI AI CODICI FE425 - FE425S

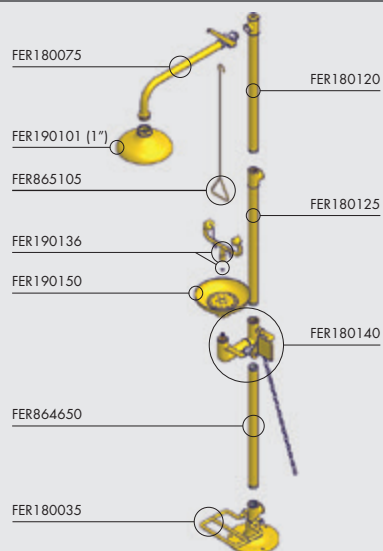

APPLICABILI AI CODICI FE426 - FE426S

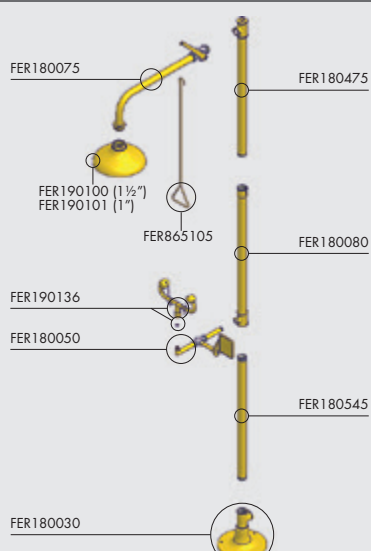

APPLICABILI AI CODICI FE470 - FE475

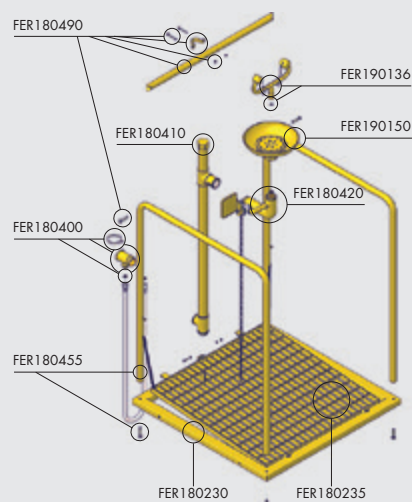



APPLICABILI AI CODICI FE222 - FE222S

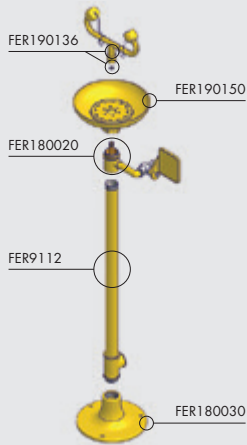

APPLICABILI AI CODICI FE224 - FE224S

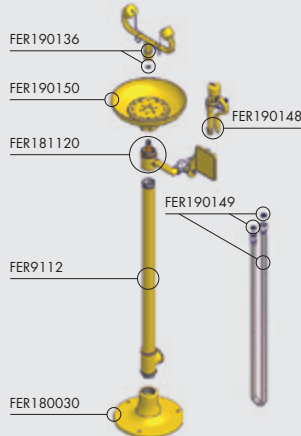

APPLICABILI AI CODICI FE271 - FE271S

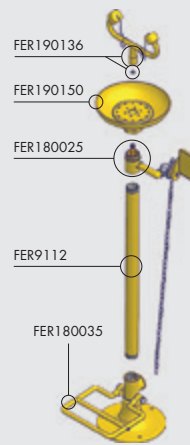

APPLICABILI AL CODICE FE310

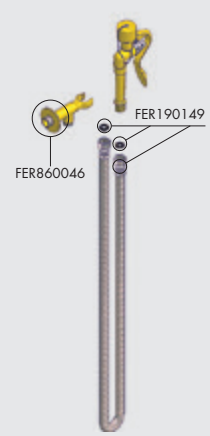

APPLICABILI AL CODICE FE351

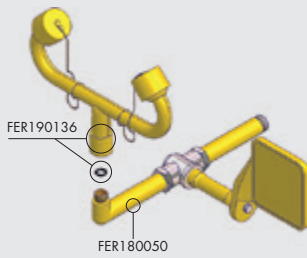

APPLICABILI AL CODICE FE112A

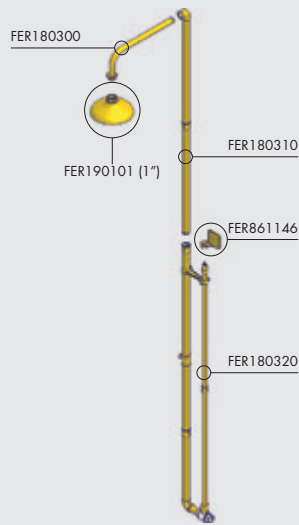

APPLICABILI AI CODICI FE422 - FE422S

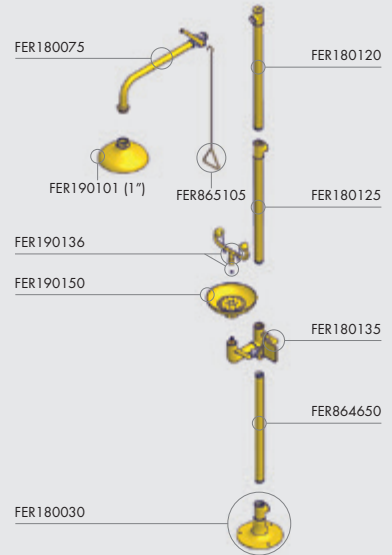

APPLICABILI AL CODICE FE471

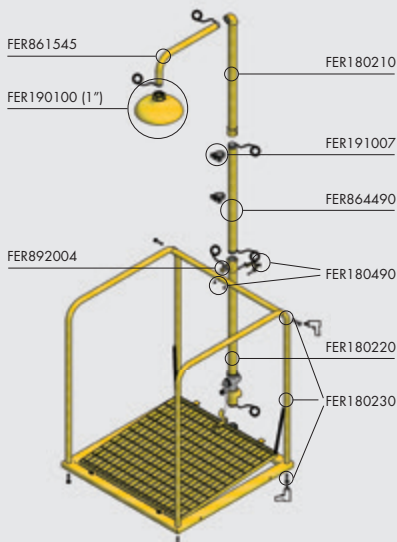

APPLICABILI AL CODICE FE473

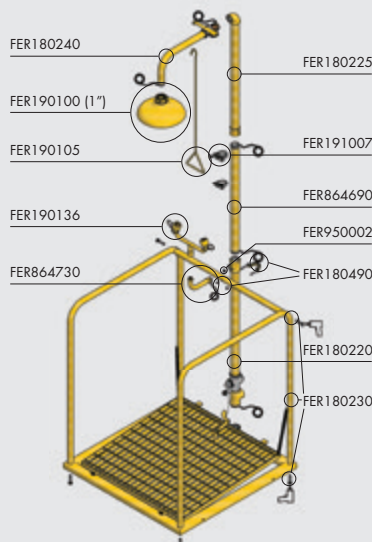

APPLICABILI AL CODICE FE481

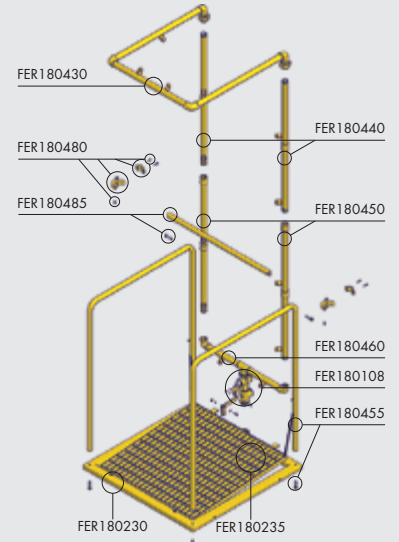

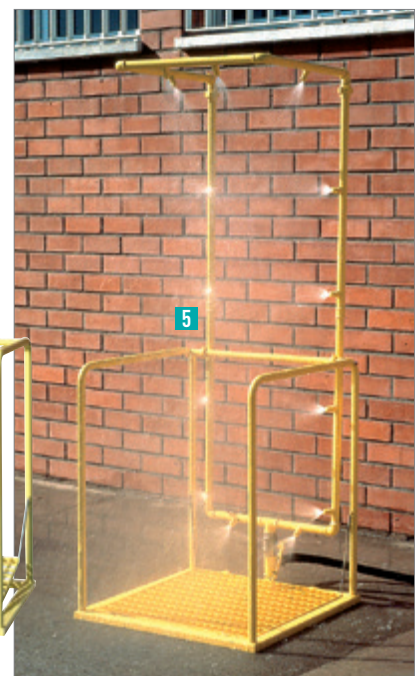
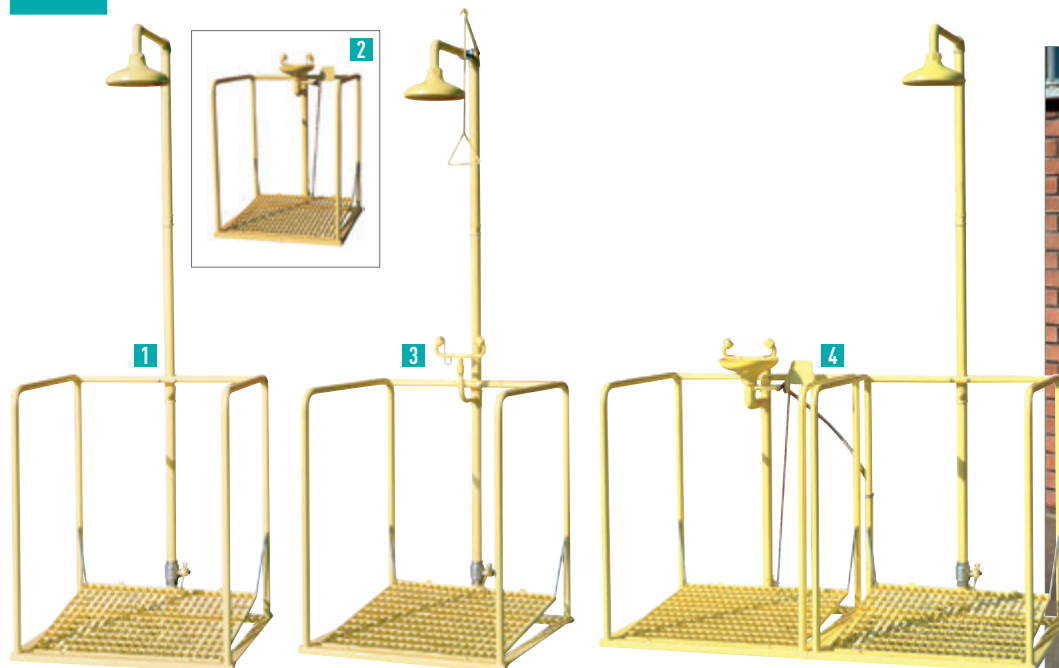

1 STAZIONE DECONTAMINAZIONE DOCCIA

Doccia a funzionamento totalmente automatico: appena una persona sale sulla pedana, la valvola a sfera si apre per poi richiudersi gradualmente quando ne discende. Alimentazione: 1-1/4".

FE471 - soffione anticorrosivo in ABS, tubazioni, mancorrente perimetrale, pedana e base portante in acciaio zincato a caldo ricoperti di resina Polyammide

2 STAZIONE DECONTAMINAZIONE LAVACCHI

Funzionamento automatico: appena una persona sale sulla pedana, la valvola a sfera si apre per poi richiudersi gradualmente quando ne discende. Erogatori lavaocchi a grande portata di acqua nebulizzata con ugelli in ottone nichelato e cromato. Alimentazione: 1-1/4".

FE475 - vaschetta anticorrosiva in ABS, tubazioni, mancorrente perimetrale, pedana e base portante in acciaio zincato a caldo ricoperti di resina Polyammide

3 STAZIONE DECONTAMINAZIONE COMPLETA

Doccia + lavaocchi. Valvola comando doccia, a sfera, in bronzo trattato galvanicamente, ad apertura istantanea e chiusura manuale. Lavaocchi totalmente automatico: appena una persona sale sulla pedana, la valvola a sfera si apre per poi richiudersi gradualmente quando ne discende. Tubazioni, mancorrente perimetrale, pedana e base portante in acciaio zincato a caldo ricoperti di resina Polyammide. Alimentazione: 1-1/4".

FE473 - stazione decontaminazione completa con soffione doccia anticorrosivo in ABS

FE473S - stazione decontaminazione completa con soffione doccia in acciaio INOX AISI 304

4 STAZIONE DECONTAMINAZIONE DOPPIA

Stazione di decontaminazione con doccia e lavaocchi con comando a pedane separate. Funzionamento totalmente automatico sia del lavaocchi, sia della doccia, appena una persona sale sulla pedana, la valvola a sfera si apre per poi richiudersi gradualmente quando ne discende. Tubazioni, mancorrente perimetrale, pedana e base portante in acciaio zincato a caldo ricoperti di resina Polyammide. Alimentazione: 1-1/4".

FE470 - stazione decontaminazione doppia con soffione doccia e vaschetta anticorrosive in ABS

FE470S - stazione decontaminazione doppia con soffione doccia e vaschetta in acciaio INOX AISI 304

5 STAZIONE DI DECONTAMINAZIONE

Funzionamento totalmente automatico, attivato dalla persona che salendo sulla pedana causa l'apertura della valvola aprendo contemporaneamente ed immediatamente tutti i 12 erogatori che garantiscono una grande portata d'acqua a getto incrociato assicurata dal numero e dalla pressione degli erogatori. Gli erogatori del tipo a cono pieno sono prerogolati ed autopulenti. Tubazioni, mancorrente perimetrale, pedana e base portante in acciaio zincato a caldo ricoperti di resina Polyammide. Altezza totale mm 2170.

FE481 - stazione ad erogatori multipli con comando a pedana

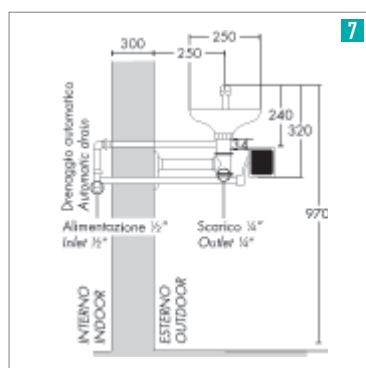

7

i È INDISPENSABILE COSTRUIRE UN TOMBINO IN CUI I PRESIDI VENGONO FISSATI CON OPPORTUNE STAFFE. TALE TOMBINO DEVE AVERE IL FONDO DRENANTE ED ESSERE RIEMPIUTO DI MATERIALE ISOLANTE.

6 LAVACCHI ANTIGELO (LOCALITÀ FREDE)

Comando a barra antipanico. Interrompendo l'erogazione, una valvola interrata munita di drenaggio automatico provvede a svuotare le tubazioni.

FE222A - senza vaschetta

7 LAVACCHI ANTIGELO

Per installazione esterna a parete. Comando a barra antipanico. Valvola con foro di drenaggio automatico per svuotare le tubazioni e alimentazione tramite tubi posti in luogo riparato all'interno della parete.

FE221A - vaschetta in ABS

8 DOCCIA ANTIGELO

Per installazione esterna a parete. Comando a tirante. Valvola con foro di scarico per svuotare le tubazioni e alimentazione tramite tubi posti in luogo riparato all'interno della parete.

FE111A - soffione in ABS





LAVACCHI A PIEDISTALLO

Lavacchi con comando a barra manuale. Particolarmente indicato per interventi d'emergenza negli impianti chimici e nei laboratori.

1 FE222 - vaschetta anticorrosiva in ABS, tubazioni in acciaio zincato a caldo e ricoperte di resina Polyammide. Alimentazione: 1/2". Scarico: 1-1/4"

FE222S - vaschetta in acciaio INOX AISI 304, tubazioni in acciaio zincato a caldo e ricoperte di resina Polyammide. Alimentazione: 1/2". Scarico: 1-1/4"

2 FEX222 - interamente in acciaio INOX AISI 304. Alimentazione: 1/2". Scarico: 1-1/4"

3 LAVACCHI A PIEDISTALLO

Lavacchi con comando a barra manuale e con pedale. Indicato per interventi d'emergenza negli impianti chimici e nei laboratori.

FE2715 - vaschetta in acciaio INOX AISI 304, tubazioni in acciaio zincato a caldo e ricoperte di resina Polyammide. Alimentazione: 1/2". Scarico: 1-1/4"

7 DOCCIA E LAVACCHI A PIEDISTALLO

Doccia a pavimento con lavacchi, comando doccia a tirante, comando lavacchi a barra antipanico e/o pedale alla base. Tubazioni in acciaio zincato a caldo ricoperti di resina Polyammide. Alimentazione: 1-1/4". Scarico: 1-1/4".

FE425 - soffione e vaschetta in ABS

FE425S - soffione e vaschetta in acciaio INOX AISI 304

8 DOCCIA E LAVACCHI A PIEDISTALLO

Doccia a pavimento con lavacchi, comando doccia a tirante, comando lavacchi a barra antipanico. Tubazioni in acciaio zincato a caldo ricoperti di resina Polyammide. Alimentazione: 1-1/4". Scarico: 1-1/4".

FE422 - soffione e vaschetta in ABS

FE422S - soffione e vaschetta in acciaio INOX AISI 304

DOCCIA E LAVACCHI A PIEDISTALLO

Doccia a pavimento con lavacchi, comando doccia a tirante, comando lavacchi a barra antipanico. Tubazioni in acciaio zincato a caldo ricoperti di resina Polyammide. Alimentazione: 1-1/4". Scarico: 1-1/4".

9 FE426 - soffione in ABS

FE426S - soffione in acciaio INOX AISI 304

10 FEX426 - interamente in acciaio INOX AISI 304. Alimentazione: 1-1/4" Gas

4 LAVACCHI A PIEDISTALLO CON EROGATORE MANUALE

Lavacchi con comando a barra manuale ed erogatore singolo supplementare da m 1,5. Indicato per interventi d'emergenza negli impianti chimici e nei laboratori.

FE224S - vaschetta in acciaio INOX AISI 304, tubazioni in acciaio zincato a caldo e ricoperte di resina Polyammide. Alimentazione: 1/2". Scarico: 1-1/4"

DOCCIA ORIZZONTALE A PARETE E VERTICALE A SOFFITTO

Comando a tirante e valvola di comando a sfera in bronzo trattato galvanicamente ad apertura istantanea e chiusura manuale. Installazione a m 2,10 dal suolo.

5 FE111 - a parete, soffione in ABS, alimentazione 1"

FE111S - a parete, soffione in acciaio INOX AISI 304, alimentazione 1"

FEX111 - a parete, interamente in acciaio INOX AISI 304, alimentazione 1"

6 FE110 - a soffitto, soffione in ABS, alimentazione 1" Gas

FEX110 - a soffitto, interamente in acciaio INOX AISI 304, alimentazione 1/2" Gas





EROGATORE DA BANCO SINGOLO E DOPPIO

Particolarmente indicato per interventi di emergenza negli impianti chimici e nei laboratori. Tubazioni in acciaio zincato a caldo e ricoperte di resina Polyammide per una lunga durata anche in atmosfere particolarmente aggressive. Valvola di comando a pulsante con chiusura automatica. Ugello in ottone nichelato e cromato. Con supporto da banco.

- 1 FE312** - lavaocchi singolo da banco
- 2 FE313** - lavaocchi doppio da banco

EROGATORE MANUALE SINGOLO E DOPPIO

Particolarmente indicato per interventi di emergenza negli impianti chimici e nei laboratori. Tubazioni in acciaio zincato a caldo e ricoperte di resina Polyammide per una lunga durata anche in atmosfere particolarmente aggressive. Valvola di comando a pulsante con chiusura automatica. Tubo di raccordo m 1,50.

- 3 FE310** - lavaocchi singolo
- 4 FE311** - lavaocchi doppio

LAVAOCCHI DOPPIO A PARETE

Tubazioni in acciaio zincato a caldo e ricoperte di resina Polyammide per una lunga durata anche in atmosfere molto aggressive. Valvola di comando a sfera, in bronzo trattato galvanicamente, con azionamento a bassa antipanico. Ugelli in ottone nichelato e cromato. Alimentazione: 1/2". Scarico: 1-1/4". Installazione a m 0,97 dal suolo.

- 5 FE221** - lavaocchi doppio da parete con vaschetta in ABS
- 6 FE221S** - lavaocchi doppio da parete con vaschetta in acciaio INOX AISI 304
- FEX221** - lavaocchi doppio da parete interamente in acciaio INOX AISI 304

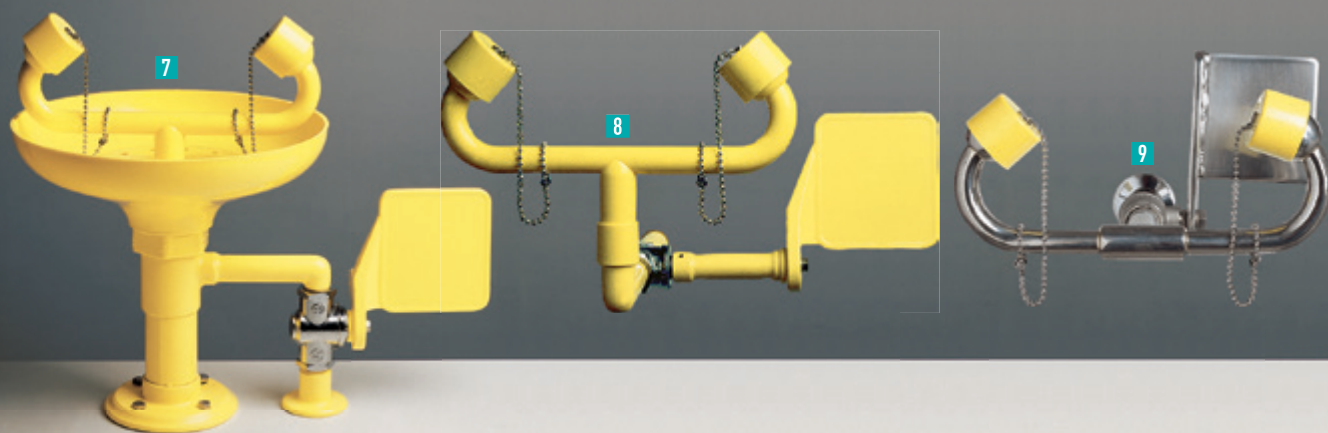

7 LAVAOCCHI DA BANCO CON VASCHETTA

Vaschetta in resina sintetica (ABS) anticorrosiva colore giallo. Azionamento a barra antipanico. Erogatori a grande portata di acqua nebulizzata. Ugelli in ottone nichelato e cromato. Tubazioni in acciaio zincato a caldo e ricoperte di resina Polyammide per una lunga durata anche in atmosfere particolarmente aggressive. Alimentazione: 1/2".

- FE212** - lavaocchi da banco con vaschetta in ABS

LAVAOCCHI A PARETE DOPPIO SENZA VASCHETTA

Particolarmente indicato per interventi di emergenza negli impianti chimici e nei laboratori. Tubazioni in acciaio zincato a caldo e ricoperte di resina Polyammide per una lunga durata anche in atmosfere particolarmente aggressive. Valvola di comando a sfera, in bronzo trattato galvanicamente, con azionamento a bassa antipanico. Ugelli in ottone nichelato e cromato.

- 8 FE351** - lavaocchi a parete doppio senza vaschetta
- 9 FEX351** - lavaocchi a parete doppio senza vaschetta in acciaio INOX AISI 304



SISTEMI E ATTREZZATURE ANTINCENDIO

ESTINTORI PORTATILI E CARRELLATI.....	460-461
CAPPUCCI DI PROTEZIONE PER ESTINTORI.....	461
PIANTANE PORTAESTINTORI E CARRELLI SCHIUMOGENI	462
CASSETTE PORTAESTINTORI E IDRANTI A MURO	463
CASSETTE E KIT A CORREDO IDRANTI	464
CASSETTE PORTADOCUMENTI E PORTACHIAVI DI SICUREZZA.....	465
RICAMBI PER IDRANTI	465
NASPI CE, RICAMBI, LASTRE DI RICAMBIO E SECCHIO PER SABBIA	466
STIVALI ANTINCENDIO E MEGAFONI.....	467
ATTREZZATURE ANTINCENDIO E KIT BORSA.....	468
COMPONENTI PER SISTEMI ANTINCENDIO	469
TROMBE A GAS E RILEVATORI DI FUMO	469
DISPOSITIVI DI BLOCCAGGIO LOCKOUT/TAGOUT	470-472
STAMPANTI PORTATILI PER ETICHETTE	472
ARTICOLI PER L'EVACUAZIONE MARITTIMA	473
LAMPADE E TORCE ATEX ANTIDFLAGRANTI	474-476
ARMADI PER ATTREZZATURE ANTINCENDIO	477-479
INDUMENTI ALLUMINIZZATI E COPERTE ANTIFIAMMA.....	480



ESTINTORI PORTATILI, AUTOMATICI E APPROVATI R.I.N.A.



ESTINTORI PORTATILI A POLVERE



Costruiti in conformità alla norma EN3-7. Serbatoio sabbato e verniciato a polvere poliestere RAL3000. Valvola a pulsante in ottone completa di valvola di sicurezza e valvola di controllo pressione. Agente estinguente polvere ABC, propellente Azoto. Temperature limite di utilizzo -30°C/+60°C. Utilizzabile anche su apparecchiature elettriche sotto tensione. Forniti con supporto a muro. I modelli da 1 e 2 kg vengono forniti con supporto portaestintori in PVC di dotazione per imbarcazione o automezzo.

- 1 EOKB01** - estintore carica kg 1, classe di fuoco 8A 34BC, Ø mm 80 x 314 h, peso kg 2
- EOKB02** - estintore carica kg 2, classe di fuoco 13A 89BC, Ø mm 102 x 376 h, peso kg 3,7
- 2 EOKB04** - estintore carica kg 4, classe di fuoco 21A 144BC, Ø mm 130 x 493 h, peso kg 6,8
- EOKM06** - estintore carica kg 6, classe di fuoco 34A 233BC, Ø mm 160 x 510 h, peso kg 9,5
- EOKF06** - estintore carica kg 6, classe di fuoco 43A 233BC, Ø mm 170 x 511 h, peso kg 10
- EOKB09** - estintore carica kg 9, classe di fuoco 55A 233BC, Ø mm 170 x 511 h, peso kg 10
- EOKB12** - estintore carica kg 12, classe di fuoco 55A 233BC, Ø mm 170 x 700 h, peso kg 16,5

ESTINTORI PORTATILI IDRICI NEBULIZZATI



Costruiti in conformità alla norma EN3-7. Serbatoio plastificato internamente sabbato e verniciato a polvere poliestere RAL3000. Valvola a pulsante in ottone completa di valvola di sicurezza e valvola di controllo pressione. Agente estinguente: schiumogeno BIC premiscelato. Temperature limite di utilizzo 0°C/+ 60°C. Forniti con supporto a muro.

- 3 EOIB02** - estintore carica lt 2, classe di fuoco 13A-70B, Ø mm 130 x 390 h, peso kg 4,65
- EOIB03** - estintore carica lt 3, classe di fuoco 13A-113B, Ø mm 130 x 490 h, peso kg 6,25
- 4 EOIB06** - estintore carica lt 6, classe di fuoco 43A-233B, Ø mm 170 x 532 h, peso kg 10,5
- EOIB09** - estintore carica lt 9, classe di fuoco 55A-233B, Ø mm 170 x 645 h, peso kg 13,5

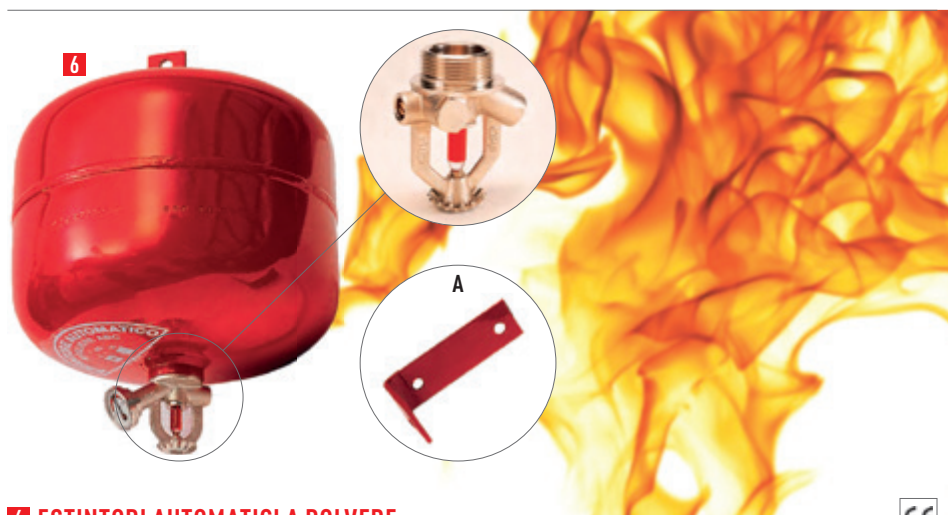

6 ESTINTORI AUTOMATICI A POLVERE



Con valvola in ottone, completo di dispositivo per la pressurizzazione e bulbo in vetro che si frantuma al raggiungimento della temperatura di pericolo. Deve essere installato a soffitto tramite supporto a corredo (A). Per una corretta installazione occorre considerare che il dispositivo automatico posto ad un'altezza di 3 metri offre una copertura di spegnimento pari a circa 9/12 m² di superficie.

EAPS06 - estintore automatico, carica kg 6 polvere ABC, dimensioni Ø mm 245 x 336, peso 8,4 kg

5 ESTINTORI PORTATILI MED A POLVERE PER EQUIPAGGIAMENTI MARITTIMI (R.I.N.A.)



Estintori conformi alla Direttiva 97/23 CE - certificati PED. Progettati per essere utilizzati a bordo di imbarcazioni per nautica da diporto, automobili, caravan, ecc. Forniti completi di supporto in PVC per fissaggio a imbarcazioni o automezzi. Utilizzabili anche su apparecchiature elettriche sotto tensione. Agente estinguente polvere ABC.

EORP01 - estintore carica kg 1, classe di fuoco 8A 34BC, Ø mm 80 x 314 h, peso kg 2

EORP02 - estintore carica kg 2, classe di fuoco 13A 89BC, Ø mm 102 x 376 h, peso kg 3,7

EORP06 - estintore carica kg 6, classe di fuoco 34A 233B-C, Ø mm 160 x 510 h, peso kg 9,4. Finito senza supporto



GUIDA ALLA SCELTA DELL'ESTINTORE ADATTO					
CLASSI	TIPO DI ESTINTORE	SI	NO	SI	SI
A	ABC	SI	NO	SI	SI
B	ABC	SI	SI	NO	SI
C	ABC	SI	SI	NO	NO
D	ABC	SI	NO	NO	NO
F	ABC	SI	SI	NO	NO

CARTELLINO "GUIDA ALLA SCELTA DELL'ESTINTORE ADATTO" (CODICE 3802) A PAGINA 140.

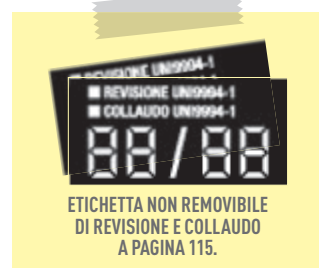

REVISIONE UNI9904-1
COLLAUDO UNI9904-1
88/88

ETICHETTA NON REMOVIBILE DI REVISIONE E COLLAUDO A PAGINA 115.



ESTINTORI CARRELLATI, PORTATILI, SUPPORTI E CAPPUCCI PER ESTINTORI



ESTINTORI CARRELLATI A CO²



Carrello con ruote separate dal corpo dell'estintore come norma, in tubo di acciaio completo di selle per il fissaggio della bombola. Bombola in acciaio sabbiata e verniciata rosso RAL 3000. Valvola e volantino in ottone completa di valvola di sicurezza contro le sovrappressioni e di tubo pescante. Manichetta erogatrice composta da tubo in gomma completa di valvola di intercettazione a sfera e cono diffusore in PVC. Agente estinguente biossido di carbonio CO².

- 1 ECCS018** - estintore carica kg 18, classe di fuoco B8 - C, Ø mm 227 x 1180 h, peso kg 67
- 2 ECCS027** - estintore carica kg 27, classe di fuoco B8 - C, Ø mm 227 x 1410 h, peso kg 85
- 3 ECCS054** - estintore carica kg 54, classe di fuoco B1 - C, Ø mm 460 x 1410 h, peso kg 174

ESTINTORI CARRELLATI A POLVERE E SCHIUMA



Polvere: carrello in acciaio completo di selle per il fissaggio del serbatoio costruito in acciaio verniciato rosso RAL 3000. Manichetta erogatrice composta da tubo in gomma con rinforzo tessile e valvola di intercettazione a sfera. Agente estinguente polvere polivalente ABC. *Schiuma:* come sopra ma con serbatoio in acciaio plastificato internamente e agente estinguente Schiuma AFFF 3%.

- 4 ECPK030** - carica kg 30, classe di fuoco A - B1 - C, Ø mm 244 x 1050 h, peso kg 58
- ECPK050** - carica kg 50, classe di fuoco A - B1 - C, Ø mm 315 x 1160 h, peso kg 84
- ECPK100** - carica kg 100, classe di fuoco A - B1 - C, Ø mm 360 x 1365 h, peso kg 152
- 5 ECSC050** - carica lt 50, classe di fuoco A - B4, Ø mm 315 x 1160 h, peso kg 84



ESTINTORI PORTATILI A CO²



Costruiti in conformità alla norma EN3-7. Serbatoio in acciaio verniciati a polvere poliestere RAL3002. Valvola a pulsante in ottone completa di valvola di sicurezza e valvola di controllo pressione. Agente estinguente Biossido di Carbonio. Forniti con supporto a muro. Temperature limite di utilizzo -30°C/+60°C.

- 6 EOCB02** - estintore carica kg 2, classe di fuoco 34B, mm 110 x 532, peso kg 6,5
- 7 EOCB05** - estintore carica kg 5, classe di fuoco 113B, mm 140 x 740, peso kg 14,5

Supporti per estintori



8 SUPPORTO PORTAESTINTORE

EPSM01 - supporto per fissaggio estintore a parete

SUPPORTI PER ESTINTORI IN ACCIAIO

Supporti per estintori a polvere da 6 a 12 kg in acciaio verniciato nero adattabili ad ogni tipo di automezzo, autocarro, autobus, treno, imbarcazione o a parete. L'estintore si fissa al supporto per mezzo di un laccio in gomma che ne assicura la stabilità anche a forti sollecitazioni e un facile e veloce sgancio al momento dell'occorrenza. Viti per il fissaggio non fornite.

- 9 EPB6** - supporto per estintori a polvere 6 kg, Ø 170 mm, altezza 425 mm
- 10 EPB9** - supporto per estintori a polvere 9 kg, Ø 170 mm, altezza 450 mm
- 11 EPB12** - supporto per estintori a polvere 12 kg, Ø 200 mm, altezza 495 mm



CAPPUCCI DI PROTEZIONE PER ESTINTORI PORTATILI E CARRELLATI

Realizzati in materiale impermeabile in grado di proteggere gli estintori normalmente situati all'aperto dall'azione corrosiva degli agenti estinguenti e dei raggi UV. Ideali per tenere i vostri estintori in perfette condizioni. Dotati di finestrella trasparente per il controllo del manometro.

- 12 EOCAP1254** - cappuccio per estintore portatile da kg 6
- EOCAP1258** - cappuccio per estintori portatili da kg 9 a 12
- 13 EOCAP1250** - cappuccio per estintore carrellato da kg 30
- EOCAP1252** - cappuccio per estintore carrellato da kg 50



PIANTANE PORTA ESTINTORI, UNITÀ MOBILI A SCHIUMA



PIANTANE PORTA ESTINTORE

Base in materiale plastico ad alta resistenza ed asta in tubolare in acciaio verniciato con polveri epossidiche o cromate.

- 1 PSE1261** - piantana verniciata colore nero, base in ABS e asta in acciaio cromato, dimensioni Ø mm 300 x 1000 h
- 2 PSE1269** - piantana cromata, base in ABS e asta in acciaio cromato, dimensioni Ø mm 300 x 1000 h
- 3 PSE1264** - piantana cromata con asta ad innesto a baionetta e cartello, base Ø mm 300 x 1900 h
- 4 PSE1265** - piantana verniciata colore nero con asta ad innesto a baionetta con cartello, base Ø mm 300 x 1900 h

PORTA ESTINTORE MODULARE IN TUBO VERNICIATO

Tubo Ø mm 25, verniciato Per estintori da kg 4 a kg 12. Fornito smontato, estintore escluso. Colori: **R** rosso **N** nero (a richiesta: **C** cromato acciaio).

- 5 PST070** - porta estintore basso cm 30 x 30 x 74 h
- 6 PST190** - porta estintore alto cm 30 x 30 x 190 h con asta e cartello bifacciale

PIANTANE PORTA ESTINTORE

In acciaio verniciato colore nero, è ideale per estintori di ogni tipo e capacità.

- 7 PST8032** - piantana mm 300 x 1030 h
- 8 PST8034** - piantana mm 300 x 2000 h con asta e cartello



9 CARRELLO PORTAFUSTI SCHIUMOGENI

Carrello per fusti da kg 200 con lanciaschiuma a bassa espansione, miscelatore variabile in lega d'alluminio, due manichette da m 20 ciascuna, due gocciolatoi salva manichetta, lancia in acciaio inox. Dimensioni: mm 780 x 1350 x 900.

ECAC165 - solo carrello con manichette UNI45 con lancia per bassa espansione



CARRELLO MOBILE PER SCHIUMOGENI

Carrello mobile per liquidi schiumogeni (esclusi). Miscelatore con dosatore e valvola di non ritorno. Attacchi unificati UNI 45 M/F. Lancia schiuma "Kugel Foam 200". Portata nominale 200 l/min. a 7 bar. Con due tubazioni Ø 45 da 20 m. A norma UNI EN 14540, con raccordi UNI804 per collegamento idrante - miscelatore - lancia. Chiave di serraggio, raccordi tipo A. Entrambi i carrelli sono utilizzabili con gli schiumogeni ECAS980, ECAS982 ed ECAS985.

10 ECAC960 - carrello mobile a schiuma S100, serbatoio 110 l, dimensioni mm 1200 x 770 x 850, peso 51 kg

11 ECAC970 - carrello mobile a schiuma S200, serbatoio 208 l, dimensioni mm 1650 x 850 x 920, peso 83 kg (con cassetta porta attrezzi e gancio traino munito di ruotino)



LIQUIDI SCHIUMOGENI

Fusti in PVC da 200 kg per le unità mobili e i carrelli Ranger illustrati in questa pagina.

ECAS980 - schiumogeno sintetico per interventi su fuochi di classe A e classe B. Approvazione EN1568

ECAS982 - schiumogeno fluoroproteico utilizzabile su idrocarburi come petrolio, gasolio, olio combustibile etc. Approvazione RINA EN1568

ECAS985 - schiumogeno sintetico AFFF di tipo filmante al 6%, utilizzabile su idrocarburi come petrolio, gasolio, olio combustibile etc. e fuochi classe A. Approvazione EN1568



1 CASSETTE PORTAESTINTORI TEXAS CON SIGILLO

In acciaio zincato verniciate con resine poliesteri speciali per esterni (ISO 9227). Fornite complete di sigillo di sicurezza numerato.

CEN664 - cassetta in acciaio verniciato colore rosso, dimensioni mm 315 x 645 x 215, per estintori kg 6

CEN666 - cassetta in acciaio verniciato colore rosso, dimensioni mm 350 x 775 x 235, per estintori kg 9-12

CEN678 - cassetta in acciaio verniciato colore rosso, dimensioni mm 335 x 835 x 170, per estintori CO2 kg 5

CASSETTE PORTAESTINTORI UTAH CON SIGILLO

Con sigillo di sicurezza numerato che, in caso d'emergenza, si rompe con uno strappo. L'apertura sulla porta è protetta da lastra infrangibile.

2 CEN61 - cassetta in lamiera verniciata colore rosso, dimensioni mm 280 x 600 x 185, per estintori kg 6

CEN91 - cassetta in lamiera verniciata colore rosso, dimensioni mm 280 x 800 x 220, per estintori kg 9 - 12 ed estintori CO2 kg 5

3 CENX61 - cassetta in acciaio inox, dimensioni mm 280 x 600 x 185, per estintori kg 6

CENX91 - cassetta in acciaio inox, dimensioni mm 280 x 800 x 220, per estintori kg 9 - 12 ed estintori CO2 kg 5

4 CASSETTA PORTAESTINTORE LEON IN MATERIALE PLASTICO

Ad altissima resistenza agli agenti atmosferici. Fondo nero coperchio rosso RAL 3000 stabilizzato per raggi UV. La cassetta viene fornita con un supporto per collocare l'estintore, completa di un laccio da 40 mm con chiusura in Nylon ad apertura rapida. Guarnizioni per garantire isolamento dagli agenti atmosferici. Materiale plastico riciclabile.

CPE2415 - cassetta in materiale plastico, dimensioni mm 316 x 641 x 225, per estintori kg 4 - 6 (altezza interna mm 530)

CPE2416 - cassetta in materiale plastico, dimensioni mm 316 x 735 x 225, per estintori kg 9 - 12 (altezza interna mm 630)



IDRANTI A MURO CERTIFICATI PER ESTERNO

Tutti gli idranti a muro sono certificati CE UNI EN 671/2 e completi di: rubinetto idrante DN 45x1 1/2 ISO 7 - PN16; tubazione Ø 45 mm certificata UNI EN 14540 completa di raccordi UNI 804, legature a norma UNI 7422 con manicotti copri legatura; sella portamanichetta; simbolo di identificazione; istruzioni d'uso d'installazione e manutenzione; lancia a leva o a rotazione; coppia di sigilli numerati; dichiarazione di conformità CE (cassette fornite vuote a richiesta).

5 MCC1920 - modello TEXAS in acciaio zincato rosso spessore 7/10, mm 450 x 530 x 200 (b x h x p), tubazione 20 m, lancia rotazione MIAMI

MCC1820 - come sopra ma con lancia a leva MISTRAL

MCC4520 - modello TEXAS in acciaio zincato **per interni** con manichetta da m 20 e lancia a rotazione MIAMI

6 MCC3702 - cassetta UTAH® in acciaio spessore 6/10 verniciato rosso e lastra infrangibile, dimensioni mm 380 x 550 x 180(b x h x p), tubazione 20 m, lancia rotazione MIAMI

MCC3710 - come sopra ma con lancia a leva MISTRAL

7 MCC3121 - modello UTAH in acciaio verniciato rosso e lastra infrangibile, mm 380 x 550 x 185 (b x h x p), tubazione 20 m, lancia rotazione MIAMI

MCC3021 - come sopra ma con lancia a leva MISTRAL

8 MCC3640 - modello RIO in polietilene alta densità rosso con portello sigillabile in policarbonato trasparente, mm 360 x 560 x 200 (b x h x p), tubazione 20 m, lancia rotazione MIAMI

MCC3540 - come sopra ma con lancia a leva MISTRAL



CASSETTE E KIT A CORREDO IDRANTI



1 CASSETTE A CORREDO IDRANTI SERIE UTAH

In **acciaio verniciato rosso**, apertura tramite strappo del sigillo di chiusura. Senza spigoli vivi, tettuccio a filo smussato. **A richiesta fornibile in acciaio inox (cod. CMNX71).**

CMN71 - cassetta vuota per esterno UTAH, mm 500 x 600 x 185

CMN824 - piantana per cassetta UTAH, h mm 800



2 CASSETTA A CORREDO IDRANTI SOTTOSUOLO MAXI

In acciaio zincato con resine poliesteri per esterni resistenti alla corrosione (ISO 9227), serratura con 2 chiavi e lastra frangibile trasparente a rottura di sicurezza. Può alloggiare un collo di cigno (previo controllo dimensioni) e la chiave per idranti sottosuolo telescopica (fornite a parte).

CMN640 - cassetta corredo idranti vuota, dimensioni (b x h x p): mm 590 x 840 x 460

CMN719 - piantana h mm 600

CMN364 - chiave telescopica per idrante sottosuolo (lunghezza da mm 700 a 1100)



CASSETTE A CORREDO IDRANTI SERIE TEXAS®

Cassette per corredo idranti soprasuolo da ubicarsi in prossimità degli idranti soprasuolo previsti dalla norma UNI 10779 (punto 6.4.1-2). In acciaio zincato spessore 10/10 verniciate colore rosso con resine poliesteri (ISO9227). **Fornite vuote** in due modelli: con 1 ripiano regolabile in altezza e senza (entrambi con sella salvamanichetta). Ante e pareti con alette di ventilazione, tetto con sporgenza antigoccia.

3 TEXAS730 - cassetta e piantana con ripiano e serratura due chiavi. Dimensioni cassetta (b x h x p): mm 450 x 650 x 250. Altezza piantana mm 630

4 TEXAS662 - solo cassetta senza ripiano con sigillo, mm 550 x 651x 260 (b x h x p)

TEXAS712 - piantana per TEXAS662, altezza mm 790

Tubazioni speciali raccordate con raccordi a norma UNI 804



5 TUBAZIONI ROSSE RED KOBRA

A norma UNI 9487, raccordi a norma UNI 804, legature a norma UNI 7422 con manicotti coprilegature. Lunghezza 20 metri.

MET1420 - DN 45 colore rosso

MET1440 - DN 70 colore rosso



7 TUBAZIONI BIANCHE JET

Omologata ENI 0198 tipo A a specifica AGIP PETROLI 9025.31 conforme alle prEN 1924 classe 1, raccordi a norma UNI 804, legature a norma UNI 7422 con manicotti coprilegature. Lunghezza 20 metri.

MET6451 - DN 45 colore bianco

MET6751 - DN 70 colore bianco



6 TUBAZIONI ROSSE SUPER JET

Omologata ENI 0198 tipo B a specifica AGIP PETROLI 9025.31 conforme alle prEN 1924 classe 2, raccordi a norma UNI 804, legature a norma UNI 7422 con manicotti coprilegature. Lunghezza 20 metri.

MET6455 - DN 45 colore rosso

MET6755 - DN 70 colore rosso



8 TUBAZIONI ROSSE YAGOM

Omologata ENI 0198 tipo C a specifica AGIP PETROLI 9025.31 conforme alle prEN 1924 classe 4. Raccordi a norma UNI 804. Legature a norma UNI 7422 con manicotti coprilegature. Lunghezza 20 metri.

MET6431 - DN 45 colore rosso

MET6731 - DN 70 colore rosso



9 COLLO A CIGNO

MCC387 - collo a cigno, attacco UNI a una bocca UNI 70

MCC3870 - collo a cigno, attacco baionetta a una bocca UNI 70



10

KIT SOPRASUOLO



KIT SOTTOSUOLO



11

11 KIT MINIMO PER CASSETTE A CORREDO IDRANTI SOPRASUOLO E SOTTOSUOLO

Kit composto da manichetta UNI 70 x 20 metri UNI9487 raccordata UNI 804, lancia a 2 effetti modello Panama e chiave per idranti sottosuolo o soprasuolo. Articoli opzionali: collo a cigno (codice MCC387 oppure MCC3870).

CMN892 - kit minimo soprasuolo con chiave pentagonale

CMN893 - kit minimo sottosuolo con chiave lunghezza mm 1100

10 TUBAZIONI UNI VIP 9487

Tubazioni Ø 70 mm in poliestere alta tenacità (Made in Italy) colore bianco a norma UNI 9487. **A richiesta fornibili da m 25 e m 30 su prescrizione specifica delle autorità competenti.**

MET1265 - DN 70 da 15 metri

MET1270 - DN 70 da 20 metri



Accessori



1 CASSETTA PORTADOCUMENTI

Cassetta portadocumenti atta a contenere il registro delle manutenzioni antincendio, i documenti di collaudo delle bombole, le chiavi degli armadi antincendio o delle cassette per estintori/manichette. In lamiera verniciata rossa RAL 3000, con serratura e 2 chiavi. Predisposta per aggancio a parete.

AST3039 - cassetta portadocumenti, dimensioni mm 300 x 390 x 60



2 CASSETTA PORTA CHIAVI DI SICUREZZA

In lamiera verniciata rossa con sigillo di sicurezza e lastra infrangibile. Predisposta per aggancio a parete.

AST1212 - cassetta, dimensioni mm 120 x 120 x 40

AST796R - lastra ricambio infrangibile
AST703R - lastra ricambio frangibile



3 SIGILLI NUMERATI

MCS100 - confezione 100 pezzi di sigilli numerati



REGISTRO ATTREZZATURE ANTINCENDIO

4 MCR037 - registro dei controlli e delle verifiche degli interventi di manutenzione delle attrezzature antincendio, dell'informazione e della formazione del personale.

5 MCR037B - registro dei controlli con le stesse caratteristiche del MCR037 ma con carta copiativa

Ricambi per idranti



6 MANICHETTE EN14540

Tubazioni flessibili Made in Italy Ø 45 mm in poliestere alta tenacità con sottostrato impermeabilizzante elastomerico certificate a norma EN14540, raccordi a norma UNI 804, legature a norma UNI 7422. Colore bianco.

MEW45/15 - DN 45 da m 15
MEW45/20 - DN 45 da m 20
MEW45/25 - DN 45 da m 25
MEW45/30 - DN 45 da m 30

SELLE SALVAMANICHETTA

7 MCS715 - sella salvamanichetta cm 33 x 14,5, in ABS colore rosso per manichette DN45 e DN70

8 MCS717 - sella salvamanichetta cm 37,5 x 12,5 in lamiera zincata colore rosso per manichette DN45 e DN70



SEGNALETICA ANTINCENDIO ALLE PAGINE 72-73.



LANCE A GETTO REGOLABILE

Lance a rotazione, getto pieno, getto frazionato e chiusura. **Conformi alla norma: UNI EN 671/2.**

9 LABM45M - UNI 45 MISTRAL senza velo, corpo e ugello in ottone e cono in Moplen. Lancia a leva con valvola di intercettazione a tre posizioni (aperto-chiuso-nebulizzato). Getto pieno K85, getto frazionato K80

10 LABM45F - UNI 45 MIAMI in nylon 6 e ottone con guarnizioni in gomma sintetica particolarmente indicata per uso navale ed in ambienti con presenza di agenti aggressivi. Lancia a rotazione: getto pieno, nebulizzazione e velo diffuso. Getto pieno K96, getto frazionato K186

11 LABM45G - UNI 45 GOLD in ottone. Lancia a rotazione: getto pieno, nebulizzazione e velo diffuso. Getto pieno K118, getto frazionato K135



14



15



12 RUBINETTI PER IDRANTE

Rubinetto per idranti con attacco maschio a 45°, in ottone fuso per manichette DN 45. Filetto gas 1 1/2" - PN 16 ISO 7 UNI EN671/2.

MCR45 - rubinetto per idranti

13 DISPOSITIVO PER MISURAZIONE PRESSIONE RESIDUA UNI 10779-07

LAB192 - giunto Ø 1 1/2" con valvola di ritegno e manometro per naspo

LAB191 - manometro

CASSETTE A MURO VUOTE PER MANICHETTE

14 CMN46 - cassetta UTAH per esterno in **acciaio verniciato rosso** con sigillo, mm 380 x 550 x 185. Versione in acciaio inox fornibile a richiesta (cod. CMNX46)

15 CMR744 - cassetta RIO® per esterno in **polietilene alta densità** con sigillo, mm 550 x 390 x 180



Naspi CE



NASPI FLORIDA CE UNI EN 671/1 CON PORTELLO PIENO O LASTRA INFRANGIBILE

Naspi a parete in acciaio spessore mm 1, verniciati con polvere poliestere spessore 70 micron rosso RAL 3000. Lancia a rotazione, valvola di intercettazione da 1", tubazione PYTON B Ø 25 mm bianco UNI EN 694. Chiusura con sigillo numerato. Tutti i modelli non hanno la lastra posteriore fornibile a richiesta.

- 1 MCN15/20** - naspo a parete, dimensioni mm 650 x 600 x 200 (b x h x p), Pyton bianco 20 m, portello pieno
- MCN15/25** - naspo a parete, dimensioni mm 750 x 700 x 200 (b x h x p), Pyton bianco 25 m, portello pieno
- MCN15/30** - naspo a parete, dimensioni mm 700 x 700 x 200 (b x h x p), Pyton bianco 30 m, portello pieno
- 2 MCN25/20** - naspo a parete Pyton bianco da m 20, dimensioni mm 650 x 600 x 200 (b x h x p), lastra infrangibile
- MCN25/25** - naspo a parete, dimensioni mm 750 x 700 x 200 (b x h x p), Pyton bianco 25 m, lastra infrangibile
- MCN25/30** - naspo a parete Pyton bianco da m 30, dimensioni mm 750 x 700 x 200 (b x h x p), lastra infrangibile

NASPI FLORIDA CE UNI EN671/1 CON PORTAESTINTORE PORTELLO PIENO O LASTRA INFRANGIBILE

Modello doppio porta naspi e portaestintori fino a kg 9 (non compresi). I naspi a parete hanno le stesse caratteristiche dei modelli FLORIDA n. 1 e 2

- 3 MCN9587** - naspo a parete, dimensioni mm 950 x 600 x 200 (b x h x p), Pyton bianco 20 m, portello pieno
- MCN9588** - naspo a parete, dimensioni mm 1050 x 700 x 200 (b x h x p), Pyton bianco 25 m, portello pieno
- MCN9589** - naspo a parete, dimensioni mm 1050 x 700 x 200 (b x h x p), Pyton bianco 30 m, portello pieno
- 4 MCN9577** - naspo a parete, dimensioni mm 950 x 600 x 200 (b x h x p), Pyton bianco 20 m, lastra infrangibile
- MCN9578** - naspo a parete, dimensioni mm 1050 x 700 x 200 (b x h x p), Pyton bianco 25 m, lastra infrangibile
- MCN9579** - naspo a parete, dimensioni mm 1050 x 700 x 200 (b x h x p), Pyton bianco 30 m, lastra infrangibile

Ricambi



LANCE, TUBAZIONI E GIUNTO

- 5 LABN25** - lancia VARIOMATIC UNI 25 a rotazione in ABS, getto regolabile
- LABG25** - lancia VARIOMATIC 1" gas F a rotazione in ABS, getto regolabile
- 6 MEW25/20** - solo tubazione PYTON bianco raccordato 20 m 1" gas M/I.R
- MEW25/25** - solo tubazione PYTON bianco raccordato 25 m 1" gas M/I.R
- MEW25/30** - solo tubazione PYTON bianco raccordato 30 m 1" gas M/I.R

7 DISPOSITIVO PER MISURAZIONE PRESSIONE RESIDUA UNI 10779-07

- LAB197** - giunto Ø 1" con valvola di ritegno e manometro per naspo
- LAB191** - manometro (ricambio per LAB197)



8 SECCHIELLO PER SABBIA

In lamiera rossa spessore 15/10 adatto per contenimento sabbia (non inclusa), versamento liquidi, copertura momentanea di prodotti infiammabili o per soffocamento piccoli incendi. Dimensioni: Ø cm 16 x 42 h.

FAP160 - secchio con coperchio

9 LASTRE DI RICAMBIO

Lastre di ricambio frangibili per cassette portamanichette, fornibili in diverse dimensioni. Safe Crash è l'unica lastra di sicurezza a prerottura certificata EN 671/2. Totalmente impermeabile dai raggi UV.

- SAF2950** - lastra di ricambio 290 x 500 mm
- SAF3052** - lastra di ricambio 300 x 525 mm
- SAF3451** - lastra di ricambio 340 x 515 mm
- SAF3852** - lastra di ricambio 380 x 525 mm
- SAF4156** - lastra di ricambio 415 x 560 mm
- SAF4257** - lastra di ricambio 422 x 570 mm





Stivali antincendio - DPI di III^a categoria



Stivali antincendio CE 0197 EN 15090: 2012 HI3 CI SRC cat. F2A. A richiesta, misure extra grandi (48-50) e parti di ricambio (sottopiedi, lacci, zip ecc.)



1 FIRE EAGLE® 2.0 E FIRE EAGLE® VARIO



Pelle fiore nera idrorepellente, spessore 2,0 - 2,2 mm, impermeabile e traspirante, antistatici. Suola in gomma, resistente al calore, eccellente resistenza contro calore, oli e benzine, non lascia segni sul pavimento in accordo alla norma EN 15090:2012. Inserti gialli [A] visibili anche attraverso il fumo sottile. Puntaletto protettivo in speciale fibra sintetica rinforzata. Strisce laterali rifrangenti, sfilamento facilitato. A norma EN ISO 15090:2012. Misure: 36-47.

1 ZCH7526.. - stivale Fire Eagle® 2.0, fodera Crosstech® Laminata Tecnologia a 3 strati. Allacciatura Haix® automatica RAPIDFIT System (brevettato) a 2 zone, per rapida e ottimale regolazione e corretta calzatura dello stivale. Altezza gambale 23 cm, esecuzione HI3 CI M AN CR - Type F2A

2 ZCH7506.. - stivale Fire Eagle® Vario, fodera Crosstech® Laminata Tecnologia a 3 strati, altezza gambale 29 cm, esecuzione HI3 CI AN SRC

3 FIREMAN YELLOW®



Stivale in pelle fiore nera idrorepellente, spessore 2,4-2,6 mm con fodera traspirante, antistatici. Suola in gomma resistente a oli e benzine con inserto in schiuma ammortizzante, antiusura, adatta per superfici stradali, resistente alle alte temperature, flessibile. Battistrada con piolo per scala e ampio appoggio del tallone. A norma EN ISO 15090/2012. Misure: 36-47.

ZCH0004.. - stivale Fireman Yellow®, esecuzione HI3 CI SRC altezza gambale 30 cm

4 FIRE FLASH® E FIRE FLASH® GAMMA



Pelle fiore nera idrorepellente, spessore 2,5 - 2,7 mm con fodera in Gore-Tex® Performance impermeabile e traspirante, antistatici. Sistema ricambio aria Haix® Climate System con fodera Micro-Dry. Suola in gomma con inserto in schiuma ammortizzante, leggera e flessibile, resistente a oli e benzine. Battistrada con piolo per scala. Copri puntaletto antiusura. A norma EN ISO 15090/2012. Allacciatura tramite zip sostituibile. Anello posteriore in pelle, lacci in Nomex®. Misure: 36-47.

4 ZCH3002.. - stivale Fire Flash®, altezza gambale 28 cm, con strisce rifrangenti senza protezione taglio motosega, esecuzione HI3 CI SRC

5 ZCH3005.. - stivale Fire Flash® Gamma, altezza gambale 28 cm, strisce rifrangenti e protezione taglio motosega livello 2, esecuzione HI3 CI SRC e EN17249

6 SPECIAL FIGHTER PRO®



Pelle fiore nera idrorepellente, spessore 2,0 - 2,2 mm con fodera in Gore-Tex® Performance impermeabile e traspirante, antistatici. Sistema ricambio aria Haix® Climate System con fodera Micro-Dry. Suola in gomma, resistente al calore, eccellente resistenza contro calore, oli e benzine, non lascia segni sul pavimento (norma EN15090:2012). Inserti gialli [A] visibili anche attraverso il fumo sottile. Puntaletto protettivo in fibra sintetica rinforzata. Allacciatura Haix® Lacing System (brevettato) con banda protettiva in pelle sovrapposta. Esecuzione HI3 CI SRC, a norma EN ISO 15090:2012. Misure: 36-47.

ZCH4016.. - stivale Special Fighter Pro®, altezza gambale 21 cm



ALTRI ARTICOLI PER VIGILI DEL FUOCO (ELMETTI, GUANTI, ABBIGLIAMENTO) ALLE PAGINE 369, 382 E 406.

Megafoni



7 MEGAFONO 10W

In ABS, volume regolabile, sirena azionabile. Indicato per manifestazioni, utilizzi scolastici, ecc. Cinghia di sicurezza regolabile sull'impugnatura. Potenza max 10W, sirena e fischietto: funzione sirena. Autonomia operativa 9 ore circa. Potenza RMS 5W. Raggio di azione fino a 500 mt (in condizioni ottimali). Peso 650 gr. Dimensioni 155 x 155 x 245 mm. Alimentazione 8 batterie stilo (AA) 1,5 Volt (non incluse).

MEGK21 - megafono 10W



8 MEGAFONO 15W

In ABS, bordatura in gomma, funzione sirena azionabile. Potenza 15 Watt. Laccio di sicurezza sull'impugnatura. Potenza max 15W, sirena e fischietto: funzione sirena. Autonomia operativa 10 ore circa. Potenza RMS 8W. Raggio di azione fino a 800 mt (in condizioni ottimali). Peso 1,1 kg. Dimensioni: 200 x 200 x 355 mm. Alimentazione: 8 batterie stilo (AA) 1,5 Volt (non incluse).

MEGK23 - megafono 15W



9 MEGAFONO 25W CON SIRENA E FISCHIETTO

Per operazioni di emergenza o soccorso. In materiale antiurto, protezione sulla tromba, potente amplificatore da 25 Watt. Volume regolabile. Comando per azionare sirena o fischietto. Potenza max: 25W, sirena e fischietto. Autonomia operativa: 5 ore circa. Raggio di azione: fino a 600 mt (in condizioni ottimali). Peso 1,65 kg. Dimensioni: 230 x 230 x 370 mm. Alimentazione: 8 batterie C mezzatorcia (non incluse). IP55.

MEGK27 - megafono 25W



FUNI, ATTREZZATURE E KIT ANTINCENDIO



1



2



3



4



5



7

PALA E FLABELLO

- 1 **FAP615** - pala battifuoco lamellare con manico in legno, lunghezza cm 150
- 2 **FAP610** - flabello battifuoco con manico in legno, lunghezza cm 100

BADILI

- 3 **FAP611** - badile antiscintilla pieghevole in alluminio, lunghezza cm 100
- 4 **FAP2264** - badile a punta forgiato, lunghezza cm 28 x 28, manico in legno cm 140

5 ASCIA PICCOLA

Testa in acciaio forgiato nera, manico in legno, con fodero in cuoio con aggancio per cintura. Manico cm 37.
FAP2197 - ascia piccola, peso kg 0,6

6 PICOZZINI E FODERI

Picozzino con impugnatura in gomma, peso kg 0,8.
A norma DIN14294.
FAP401 - picozzino in acciaio con fodero.

7 ASCIA

Ascia con testa in acciaio forgiato nero e manico in legno.
FAP900 - ascia cm 90, peso kg 3,3



8

CONTENUTO BORSA

- **ELV031Y** - 1 elmo professionale per V.V.F.
- **TNI420** - 1 torcia antideflagrante a batterie
- **ZCH0004** - 1 paio di stivali professionali per V.V.F. (indicare misura)
- **RSD999** - 1 maschera pieno facciale
- **RSD5470** - 1 filtro ABEK2 HG P3
- **TAX03** - 1 tuta in tessuto Metaaramidico Rip-Stop (indicare taglia)
- **GA2049/.** - 1 paio di guanti anticalore (indicare taglia 9 o 10)
- **FBA1520** - 1 coperta antinfiamma
- **FAP401** - 1 picozzino in acciaio con fodero

8 KIT ANTINCENDIO IN BORSA

Utile per attività mobili tipo cantieri e simili. **A richiesta fornibile diversa dotazione.**

- BPS245** - borsa piena in nylon, cm 60 x 40 x 100
- BPSV245** - borsa in nylon fornita vuota



9



10



11



13

12

FUNI DI SERVIZIO

Lunghezza m 20, **fornite complete di moschettone.**

- 9 **FAP121** - fune in poliestere alta tenacità Ø mm 12
- 10 **FAP120** - fune in poliestere media tenacità Ø mm 12

CORDE CON INSERTI RIFLETTENTI

Lunghezza m 20.

- 11 **FAP126** - in poliestere Ø mm 6 con inserti in tessuto riflettente
- 12 **FAP420** - in filato di Kevlar antiacido e anticalore Ø mm 10, inserti in Reflex. Impalmatura e redance alle 2 estremità.

13 CORDA AD ALTA RESISTENZA

In filato di Kevlar antiacido e anticalore. Completa di impalmatura e redance alle due estremità. **Fornibili a richiesta altre lunghezze.**
FAP421 - corda ad alta resistenza Ø mm 10, lunghezza m 20



PULSANTI MANUALI RIPRISTINABILI EN54-11:2001

Pulsanti in termoplastico di colore rosso per la segnalazione manuale di incendio, conforme alla norma EN54-11 a rottura vetro o ripristinabili. Nella versione ripristinabile, una pressione al centro dell'elemento plastico provoca l'attivazione dell'allarme segnalata dal cambio di colore nella zona superiore dell'elemento stesso. La chiave in dotazione oltre a permettere il ripristino del pulsante ha anche la funzione di chiave di test e attrezzo di apertura del pulsante.

- 1 FAL2570** - pulsante ripristinabile mm 87 x 87 x 53. Contatti: 1 in scambio; corrente max contatti: 3 A; tensione max contatti: 24 Vcc; IP42. Per interni
- 2 FAL2571** - pulsante ripristinabile mm 110 x 110 x 65. Contatti: 1 in scambio; corrente max contatti: 3 A; tensione max contatti: 24 Vcc; IP67. Per esterni

CONTENITORI PER CHIAVI

Disponibili in due formati, piccolo e grande, in colore rosso.

- 3 FAL1492 - contenitore per chiavi piccolo** (per una chiave). Corpo in alluminio pressofuso completo di martelletto e 2 vetri di ricambio, microinterruttore in scambio. Dimensioni: mm 95 x 95 x 43
- 4 FAL1498 - contenitore per chiavi grande**. Corpo in lamiera acciaio, microinterruttori a protezione di rottura vetro, apertura coperchio e asporto chiave. Chiusura a chiave. Dimensioni: mm 120 x 160 x 61

RICAMBI

- FAL1498R** - vetrino di ricambio per FAL1498, minimo ordinabile 10 pezzi/multipli
- FAL1492R** - vetrino di ricambio per FAL1492, minimo ordinabile 10 pezzi/multipli
- 5 FAL1471** - martelletto per rottura vetri



TROMBE A GAS CONFORMI ALLA DIRETTIVA EUROPEA N. 517/2014. MINI RILEVATORE OTTICO DI FUMO CERTIFICATO CE 0786, NF 292 DAAF, VdS G204132, EN14604.

TROMBA A GAS CON ATTACCO A SCATTO

Conforme alla Direttiva Europea n. 517/2014. Tromba completa di bombola monoblocco in alluminio, caricata a gas ecologico non infiammabile per l'ambiente (HFO 1234ze). Da utilizzarsi in ambito industriale come avvisatore di allarme nelle officine, in ambito nautico come avvisatore di sicurezza sulle imbarcazioni e in ambito sportivo in stadi o palazzetti.

- 6 OSC459** - tromba a gas: bombola da 200 ml con corno lungo
- 7 OSC459R** - tromba a gas: bombola di ricambio da 200 ml

8 MINI RILEVATORE OTTICO DI FUMO

Sensore per l'individuazione precoce degli incendi. Caratteristiche: griglia anti intrusione insetti, pulsante di autotest, dispositivo di allarme momentaneo, led indicatore di funzionamento, avviso di esaurimento delle batterie, bip extrapotente a 85dB, alimentazione 9V. Batterie incluse. **Certificazioni: CE 0786, NF 292 DAAF, VdS G204132, EN14604.**

FAP2329 - mini rilevatore ottico di fumo, dimensioni Ø mm 70 x 30



9 AVVISATORE OTTICO

Permette di portare a distanza una segnalazione d'allarme, in anomalia, acceso-speinto od altro mezzo di un led ad alta luminosità e basso assorbimento. Visione a 180°. Luce fissa o lampeggiante. Connessione a morsetti. Frequenza di lampeggio 60/min. Alimentazione/assorbimento 12/24 Vcc/6mA.

FAL1490 - avvisatore ottico fisso/lampeggiante rosso mm 50 x 45 x 25



10 PANNELLO DI SEGNALAZIONE ALLARME INCENDIO PER ESTERNI

Dispositivo di segnalazione stato di allarme all'interno di impianti di rivelazione incendio, certificato secondo gli standard EN54. Segnalazione ottica con elevato volume di copertura (W-3,5-9), segnalazione acustica con pressione sonora frontale di 88 dB a 1m. Dicitura "ALLARME INCENDIO" retroilluminata LED. Installazione a parete. Grado di protezione IP54.

FAL5965 - pannello di segnalazione a led "ALLARME INCENDIO", mm 365 x 147 x 53, peso 775 g



11 CAMPANA 6 POLLICI 24 V

Progettata per l'uso in sistemi d'allarme, d'incendio o in sistemi industriali. Elevata efficienza acustica, bassi consumi. Funzionamento mediante motore, pignone e percussione, tipo di connessione morsetto per ingresso/uscita. Alimentazione/assorbimento 24 Vcc/25 mA, pressione acustica 93 dB a 1m. Calotta acciaio base policarbonato, smaltata.

FAL4476 - campana Ø mm 150 x 60 h



COSA SI INTENDE PER LOCKOUT/TAGOUT?

Il Lockout/Tagout è una procedura di sicurezza che blocca la fonte energetica in caso di intervento su una macchina. Tale procedura protegge gli operatori da qualunque rischio legato al riavvio accidentale degli impianti o ai contatti elettrici.

MINORI TASSI DI INFORTUNIO E RELATIVI COSTI

I dati dell'Unione europea dimostrano che il 10-15% di tutti gli infortuni mortali sul luogo di lavoro e il 15-20% di tutti gli incidenti sono legati alla manutenzione. I costi derivanti dagli infortuni possono essere esorbitanti.

CONTROLLO EFFICACE DELL'ENERGIA PERICOLOSA

Garantire la disattivazione e l'isolamento di tutte le energie potenzialmente pericolose che alimentano attrezzature per la produzione o la gestione dell'impianto in modo che l'apparecchiatura possa essere sottoposta in tutta sicurezza a interventi di riparazione o manutenzione. Lockout/Tagout sono una gamma di dispositivi meccanici che, allorché vengono utilizzati o attivati, impediscono fisicamente la trasmissione o il rilascio di energia, tra cui:

- un interruttore elettrico azionato manualmente
- un sezionatore
- una valvola di chiusura a saracinesca/sfera/farfalla

ENERGIE PERICOLOSE DA CONTROLLARE

Elettrica, meccanica, pneumatica, idraulica, sostanze chimiche liquide e gassose, termica, superfici e sostanze calde, gravitazionale, oggetti o apparecchiature sospese che possono cadere e schiacciare, altra energia accumulata, volano arrestato a metà movimento, energia elettrica residua da scaricare.



A RICHIESTA TRAINING INTERATTIVO LOCKOUT/TAGOUT (RICHIEDI PREVENTIVO).

! NELLE ATTREZZATURE IMPIEGATE PER LA PRODUZIONE IN IMPIANTI O STRUTTURE, GENERALMENTE SONO PRESENTI PIÙ DI 2 TIPI DI ENERGIA. L'ATTUAZIONE DI PROCEDURE DI LOCKOUT/TAGOUT È LA NORMA IN ALCUNI PAESI DELL'UE ED È CONSIDERATA LA MIGLIORE PRASSI IN TUTTI I PAESI EUROPEI.



DIMENSIONI

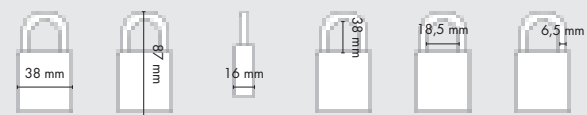

1 LUCCHETTI DI SICUREZZA INTERAMENTE IN NYLON

Lucchetti con arco in plastica: esclude il passaggio di corrente elettrica tra l'arco e la chiave, non genera scintille, sistema di ritenuta della chiave (la chiave non viene rilasciata fino alla perfetta chiusura dell'arco). I lucchetti sono forniti con etichette DANGER e PROPERTY OF e con **chiavi diverse**. Una chiave in dotazione ad ogni lucchetto. Minimo ordinabile 6 pezzi/multipli per colore. Colori fornibili:

R rosso **Y** giallo **G** verde **B** blu **A** arancio **N** nero

LOC15. - lucchetto di sicurezza, colori vari



DIMENSIONI

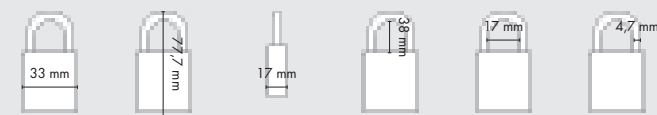

2 LUCCHETTI DI SICUREZZA CON CORPO IN NYLON E ARCO IN ALLUMINIO

Lucchetti compatti e leggeri (peso 65 gr), facili da utilizzare. Corpo in nylon non conduttivo e arco in alluminio. **Arco Ø mm 4,7 adatto per piccoli fori**. Sistema di ritenuta chiave, temperatura massima di utilizzo 120°C. I lucchetti sono forniti con etichette DANGER e PROPERTY OF e con **chiavi diverse**. Una chiave in dotazione ad ogni lucchetto. Minimo ordinabile 6 pezzi/multipli per colore. Colori fornibili:

R rosso **Y** giallo **G** verde **B** blu **A** arancio **N** nero

LOC18. - lucchetto di sicurezza, colori vari



DIMENSIONI

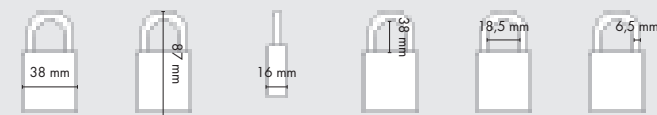

3 LUCCHETTI DI SICUREZZA CON CORPO IN NYLON E ARCO IN ACCIAIO

Lucchetti da utilizzare solo in applicazioni di bloccaggio di sicurezza. Resistenti alla corrosione (prodotti chimici), arco di 38 mm che si adatta alla maggior parte degli utilizzi. Ø mm 6,5. Con ogni lucchetto sono fornite 2 etichette e 1 chiave. **Chiavi tutte diverse**. Minimo ordinabile 6 pezzi/multipli per colore. Colori fornibili:

R rosso **Y** giallo **G** verde **B** blu **A** arancio **N** nero

LOC13. - lucchetto di sicurezza, colori vari

i **TUTTI I LUCCHETTI RAFFIGURATI POSSONO ESSERE FORNITI, A RICHIESTA, IN ALTRE TRE DIFFERENTI TIPOLOGIE: CON CHIAVI TUTTE UGUALI, CON CHIAVI TUTTE UGUALI E UN PASSE-PARTOUT, CON CHIAVI TUTTE DIVERSE E UN PASSE-PARTOUT. RICHIEDI UN PREVENTIVO.**

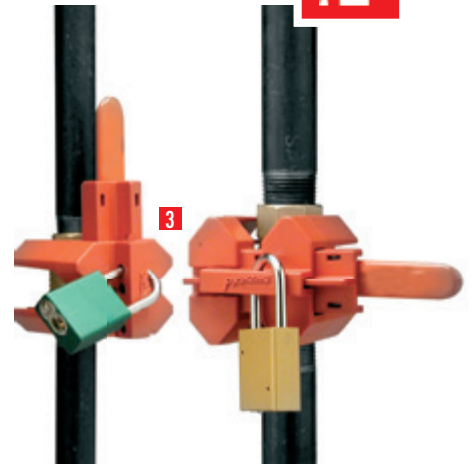
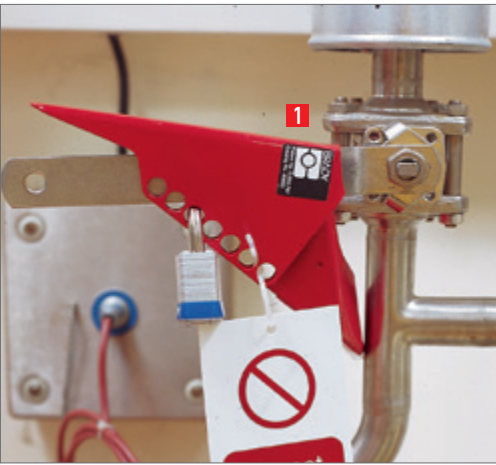

CON L'AGGIUNTA DI UNA BARRA SUPPLEMENTARE È POSSIBILE BLOCCARE LA VALVOLE IN UNA POSIZIONE INTERMEDIA. CON L'AGGIUNTA DI UN CAVO IN ACCIAIO RICOPERTO, È POSSIBILE BLOCCARE LE VALVOLE A VOLANTINO. USANDO SOLO IL CORPO CENTRALE È INVECE POSSIBILE BLOCCARE LE VALVOLE A FARFALLA.

1 DISPOSITIVO BLOCCA VALVOLE PER VALVOLE A SFERA

Ideale per bloccare valvole a sfera di tutte le lunghezze, tonde, quadrate, piatte, impedendo regolazioni non autorizzate. Il bloccaggio consente solo la posizione chiusa ad angolo retto per valvole con comando a leva. Il dispositivo va utilizzato con i lucchetti di chiusura.

CARATTERISTICHE DISPOSITIVI BLOCCA VALVOLE				
CODICE	LARGHEZZA LEVA DA/A	DIAMETRO MAX ANSA LUCCHETTO	ALTEZZA ANSA LUCCHETTO	MATERIALE
LOC76	6 - 25 mm	7 mm	25 mm	Nylon
LOC74	6 - 25 mm	9,5 mm	19 mm	Acciaio
LOC77	32 - 76 mm	7 mm	19 mm	Acciaio
LOC75	32 - 76 mm	9,5 mm	19 mm	Acciaio

2 DISPOSITIVO DI BLOCCAGGIO VALVOLE A SFERA

Il dispositivo ha una struttura in plastica e acciaio e permette di bloccare le valvole a sfera in posizione chiusa oppure aperta. resistente agli acidi.

- LOC01** - dispositivo **piccolo** bloccaggio valvole larghezza max 25 mm
- LOC02** - dispositivo **grande** bloccaggio valvole larghezza max 41 mm
- LOC03** - barra supplementare piccola
- LOC04** - barra supplementare grande
- LOC05** - cavo in acciaio mt 2,44 x Ø mm 3,25

3 DISPOSITIVO DI BLOCCAGGIO VALVOLE

Sistema concepito per chiudere una grande varietà di valvole a sfera. Composto da due elementi che bloccano la valvola.

- LOC10** - dispositivo, dimensioni: aperta da mm 12,5 a 31, chiusa da mm 32 a 72
- LOC11** - dispositivo, dimensioni da 50 a 200 mm solo chiusa

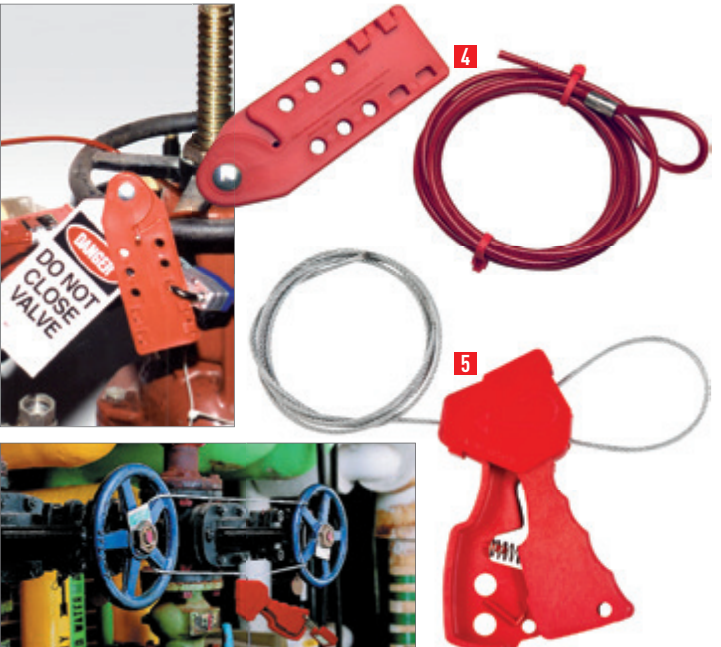

4 SISTEMA DI BLOCCAGGIO A CAVO PER VALVOLE

Cavo flessibile da 1,8 m in acciaio, rivestito da una guaina di plastica e al sistema di chiusura a ganasce di sicurezza che accetta fino a 6 lucchetti con una massima larghezza dell'ansa da 7 mm.

- LOC112** - dispositivo di bloccaggio a cavo per valvole, cavo da 1,8 m

5 DISPOSITIVO DI BLOCCAGGIO VALVOLE A SARACINESCA

Sistema di chiusura tramite cavo brevettato. Ideale per situazioni complesse come grandi valvole a saracinesca o dispositivi sovradimensionati. È sufficiente schiacciare il dispositivo per serrare il cavo e introdurre il lucchetto per bloccare la maniglia. Corpo realizzato in nylon con cavo in acciaio galvanizzato.

- LOC318** - dispositivo di bloccaggio valvole a saracinesca, colore rosso, h mm 182,7, larghezza mm 72, lunghezza cavo m 1,8
- LOC320** - cavo aggiuntivo lunghezza m 3



6 DISPOSITIVI DI BLOCCAGGIO VALVOLE A VOLANTINO

Un sistema sicuro e semplice di chiusura delle valvole a volantino. Disponibile in 5 dimensioni per volantini da 2,5 a 32 cm di diametro. In polipropilene resistente alle sostanze chimiche, al calore e al freddo (-30 C° + 300°C).

- LOC31** - per volantino Ø da mm 25 a 64
 - LOC32** - per volantino Ø da mm 64 a 127
 - LOC33** - per volantino Ø da mm 127 a 165
 - LOC34** - per volantino Ø da mm 165 a 254
 - LOC35** - per volantino Ø da mm 254 a 320
- Colori fornibili: **R** rosso **Y** giallo **G** verde **B** blu



SISTEMA DI BLOCCAGGIO INTERRUTTORI EUROPEI

Sistema robusto, in nylon caricato con fibra di vetro. Da utilizzare in combinazione con un lucchetto con l'arco da Ø mm 6,5.

- 7 LOC844** - sistema tipo 1
- 8 LOC847** - sistema tipo 2
- 9 LOC850** - sistema tipo 3
- 10 LOC853** - sistema tipo 4



DISPOSITIVI DI BLOCCAGGIO E STAMPANTI PER ETICHETTE



1 GANASCE DI SICUREZZA

Consentono il bloccaggio della fonte di energia a 6 differenti operatori. Il macchinario non potrà essere sbloccato fino a quando non sarà stato rimosso l'ultimo lucchetto. Costruiti in acciaio inossidabile rivestito in vinile, antiruggine, alloggiano fino a 6 lucchetti. Compatibili con lucchetti con arco Ø max 9,5.

LOC29 - ganascia Ø interno mm 25

LOC30 - ganascia Ø interno mm 38

2 LOCK BOX PER LUCCHETTI

Per riporre una o più chiavi del macchinario bloccato. Ogni membro autorizzato applica un lucchetto personale: questo garantisce che nessun operatore abbia accesso alla lock box a meno che tutti gli operatori non abbiano rimosso il proprio lucchetto.

LOC699 - in lamiera d'acciaio colore rosso, mm 227 x 152 x 88,9 (b x h x p), per 13 lucchetti

3 PANNELLO PER LUCCHETTI

Pannello per lucchetti in resistente materiale acrilico ad alta visibilità. **Fornito vuoto.**

LOC990 - pannello per 10 lucchetti mm 342 x 342

4 STAZIONE LOCKOUT

In robusto polipropilene, provvista di fori per l'applicazione a muro. Preforata per l'applicazione di ganci che possono essere disposti in vari modi. Dimensioni mm 432 x 432 x 171 (b x h x p) **Fornita vuota.**

LOC217 - stazione portatile



5 STAMPANTE M211 PER ETICHETTE

Crea, visualizza in anteprima e stampa etichette, tutto dal tuo smartphone! Robusta etichettatrice industriale studiata per sopportare condizioni difficili in qualsiasi luogo di lavoro: resiste a cadute da 1,8 metri, schiacciamenti di 110 kg e urti secondo i requisiti delle specifiche militari. Ideale per etichettatura di fili e cavi, materiale elettrico, telecomunicazioni, logistica, magazzini ed etichettatura Lean e 5S. Può stampare fino a 300 etichette con una sola ricarica completa della batteria. Batteria capacità 1200 mAh, tempo di ricarica 4 ore. Connessione Bluetooth veloce e affidabile. Dimensioni 137 x 101 x 66 mm, peso 0,5 kg.

LOC9536 - stampante monocolor per etichette larghezza massima 19 mm

6 STAMPANTE PORTATILE M210 PER ETICHETTE

Stampante portatile all-in-one a trasferimento termico per etichette per impianti elettrici, cablaggio strutturato e applicazioni industriali in generale. Robusta e resistente, con protezioni angolari in gomma, resiste a cadute da 1,8 metri e urti secondo i requisiti delle specifiche militari. Semplice da usare, con accessorio multifunzione magnetico. Simboli incorporati: 193. Cartucce sostituibili, batteria a ioni di litio ricaricabile (tempo di ricarica 2,5 ore), garanzia di 2 anni. Dimensioni 114 x 241 x 63,5 mm, larghezza display 56 mm, peso 0,75 kg.

LOC9537 - stampante monocolor portatile per etichette

7 TARGHETTE LAMINAT™

Targhette autoadesive in polipropilene con pellicola sovrallaminata in poliestere, colore giallo, per l'identificazione di materiale tra cui: valvole, strumenti, motori e altri componenti industriali.

LOC322 - confezione da 50 targhette con anello rinforzato con rivetto, dimensioni mm 59 x 25 h

8 VINILE PER STAMPANTI M210 E M211

Resiste al grasso, all'olio e a gran parte dei prodotti chimici industriali. 8-10 anni di durata media all'aperto con temperature da -40°C a 82°C. Colori:

- R** scritta bianca, fondo rosso
- G** scritta bianca, fondo verde
- B** scritta bianca, fondo blu
- A** scritta nera, fondo arancio
- W** scritta nera, fondo bianco
- Y** scritta nera, fondo giallo

LOC798 - vinile h 12,7 mm x lunghezza 6,4 m, colori vari

LOC794 - vinile h 19 mm x lunghezza 6,4 m, colori vari





1 SALVAGENTE A STOLA

In espanso morbido, fibbia a sgancio rapido. **Omologato EN ISO 12402**. Taglia per adulti oltre 40 kg. **OSC451** - salvagente a stola



2 SALVAGENTE AUTOGONFIABILE

Colore blu, ideale per essere indossato sempre. Anello di emergenza per cintura di sicurezza. Modello per adulti. **Omologato EN ISO 12402-3**. **OSC398** - salvagente autogonfiabile ad attivazione automatica



3 GIUBBOTTO SALVAGENTE AURORA

Ingombro minimo, alta visibilità, nastri retroriflettenti, fischietto omologato. Fibbie a sgancio rapido, maniglia di sollevamento. Taglia oltre 70 kg. **OSC482** - giubbotto salvagente a norma EN ISO 12402-4



SALVAGENTE ANULARE MED CON VANO

Provisto di vano per alloggiamento boetta luminosa elettronica OSC432.

4 OSC433 - salvagente anulare, Ø cm 40 x 64

5 OSC434 - fascia porta salvagente



6 SALVAGENTE ANULARE

In Eltex, con fasce retroriflettenti, riempito in poliuretano espanso. Omologato per diporto secondo il D.M. 385/99.

OSC439 - salvagente anulare, Ø cm 40 x 60



7 BOETTA LUMINOSA STARI

Accensione automatica a rovesciamento. Omologata RINA secondo direttive 96/98 EC + 98/85 EC. Regolamento secondo D.M. 385 del 29/09/1999. Alimentazione: 4 pile LR20 1,5V.

OSC584 - boetta luminosa mm 350 x 120



8 BOETTA FUMOGENA GALLEGGIANTE MAYDAY

Approvata dal Ministero dei Trasporti e della Navigazione in accordo con la Normativa SOLAS 83/96, certificato internazionale Marine Equipment.

OSC115 - boetta fumogena galleggiante



9 STAFFA

In acciaio inox, modello universale per salvagenti anulari e boetta luminosa OSC584.

OSC426 - staffa portasavagente anulare universale in acciaio inox



10 BOETTA LUMINOSA ELETTRONICA

Boetta luminosa a norma Marine Equipment, omologazione CCE39829, testata ed approvata RINA. Si attiva automaticamente a contatto dell'acqua (per salvagente OSC431).

OSC432 - boetta luminosa elettronica Sealux



11 SEGNALATORE ELETTRONICO AUTOMATICO

Segnalatore elettrico automatico per cinture di salvataggio. Omologato MED 178515WS/003, MED 171115 WS/002. Tripla funzione: lampeggio veloce, lampeggio SOS, luce fissa oppure spento. Accensione automatica a contatto con acqua.

OSC409 - dimensioni mm 62 x 28 x 31,5

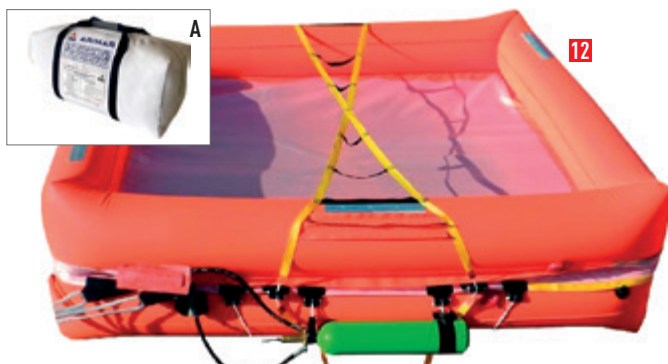

12 ZATTERA DI SALVATAGGIO

Autogonfiabile, per navigare fino a 12 miglia dalla costa. Omologata secondo D.M. 29/07/2008 + D.D. 02/03/2009. Prima revisione dopo 3 anni, successive revisioni ogni 2 anni dalla precedente. Fornibile a richiesta per 4, 8, 10 o 12 persone.

OSC703 - zattera a 6 posti cm 66 x 26 x 28, peso kg 2, contenitore sacca morbida (A)



13 FISCHIETTO IN PLASTICA

Fischietto a norma RINA (senza pallina) per giubbotti di salvataggio.

OSC755 - fischietto in plastica

14 CIMA GALLEGGIANTE

Cima in Levilene galleggiante per salvagente anulare. Colore arancione (a richiesta fornibile bianca), fornita senza moschettone.

OSC408A - cima galleggiante Ø mm 8, lunghezza 30 metri



15 FUMOGENO

Accensione a sfregamento, ritardo di accensione 2 secondi, durata 60 secondi (50 secondi +/-10). Colore giallo (altri colori fornibili a richiesta).

CSC001Y - fumogeno colore giallo, minimo ordinabile 10 pezzi



CHE COS'È LA TECNOLOGIA DUAL LIGHT™?

La tecnologia Dual Light™, presente su molti modelli torce antideflagranti Nightstick™, di queste pagine, consente di illuminare in maniera ottimale contemporaneamente in due direzioni (frontale e verso il basso). Così facendo, si riduce considerevolmente il rischio di inciampo in ambienti poco illuminati.



ALTRE TORCE PER ELMETTI A PAGINA 371.

NEW

DUAL LIGHT™ TECHNOLOGY



ATTACCO A BAIONETTA PER ELMETTI INCLUSO



1



2

1 TORCIA LED DA TESTA E PER ELMETTI

Torcia ATEX frontale fornita con doppia banda in gomma per elmetti e in tessuto per la testa, antiscivolo per applicazione all'elmetto. Autonomia da 13 a 22 ore. Funzionamento con 3 batterie alcaline AAA incluse. Lente in policarbonato antigraffio. Testa inclinabile con interruttore singolo situato sopra la torcia per selezionare l'inclinazione desiderata e l'intensità della luminosità (high or low) distanza raggio fino a 80 m. Certificata IP67. **Atex II 1 G Ex ia op is IIC T3 Ga.**

TNI450 - torcia ATEX per elmetti a led, lunghezza 61 mm, peso gr 99 con batterie, Lumen 90

2 TORCIA LED DA TESTA E PER ELMETTI

Torcia ATEX frontale Dual-Light™ multifunzione. Testa inclinabile con doppio interruttore per selezionare le 5 modalità disponibili: riflettore (alta o bassa intensità luminosa), proiettore (alta o bassa intensità luminosa), Dual-Light™. La torcia viene fornita con doppia banda in gomma per elmetti e in tessuto con fodera antiscivolo per la testa, oltre all'attacco a baionetta. Impermeabile, resistente agli urti e agli agenti chimici. Alimentazione: 3 batterie AAA (incluse). Certificata IP67. **Atex II 1 G Ex ia op is IIC T3 Ga.**

TNI454 - torcia ATEX a led da testa e per elmetti, dimensioni 53 x 66 x 46 mm profondità, peso gr 94 con batterie, Lumen 160

TNI554 - stesse caratteristiche della TNI454 ma con batteria al litio a ricarica magnetica USB MagMate™ (cavo incluso)



3

DUAL LIGHT™ TECHNOLOGY

NEW



3 TORCIA LED PER ELMETTI ANTINCENDIO

Torcia ATEX frontale Dual-Light™ multifunzione, progettata per essere posizionata su elmetti antincendio e elmetti dotati di visiera ribaltabile. L'esclusiva forma a basso profilo consente all'utente di lavorare senza dover rimuovere la lampada frontale quando si alza o si abbassa la visiera. Alloggiamento in polimero di nylon rinforzato con fibra di vetro. Cinturino in gomma per elmetti antincendio (per impieghi gravosi). Testa inclinabile con doppio interruttore per selezionare le 5 modalità disponibili: riflettore (alta o bassa intensità luminosa), proiettore (alta o bassa intensità luminosa), Dual-Light™. Impermeabile, resistente agli urti e agli agenti chimici. Alimentazione: 3 batterie AAA (incluse). Il pacco batterie è situato nella parte posteriore del cinturino. Certificata IP67. **Atex II 1 G Ex ia IIC T4 Ga.**

TNI462 - torcia ATEX a led per elmetti, dimensioni 32 x 95 x 25 mm profondità, peso gr 265 con batterie, Lumen 310

TNI562 - stesse caratteristiche della TNI462 ma con batteria al litio a ricarica magnetica USB MagMate™ (cavo incluso), Lumen 300



4



4 TORCIA LED

Torcia ATEX con clip per aggancio a cintura e presa antiscivolo, per l'uso in luoghi pericolosi sia sopra che sotto terra, dove possono essere presenti gas e polveri esplosivi. Autonomia di 14 ore. Funzionamento con 3 batterie alcaline AA (non incluse). Lente in policarbonato infrangibile antigraffio. Cordino removibile incluso. Interruttore singolo a corpo, distanza raggio fino a 187 m. Certificata IP67. **Atex Zona 0 II 1 G Ex ia op is IIC T3 Ga.** Lumen 210.

TNI420 - torcia ATEX a led con clip, lunghezza 178 mm, peso gr 207 con batterie



1

CERTIFICATA IP67



2

DOPPIO INTERRUOTTORE



MAGNETE INTEGRATO



1 TORCIA LED DUAL LIGHT™ CON MAGNETE



Torcia ATEX con magnete integrato all'estremità per posizionarla lasciando le mani libere. Clip per tasca removibile e clip montaggio per elmetto incluse. Proiettore integrato per illuminazione da vicino, 2 interruttori per gestire il sistema a doppio led: fascio luce in avanti e verso il basso in prossimità dell'operatore (utilizzabili alternati o contemporaneamente) per garantire massima sicurezza ed efficienza. Funzionamento con 2 batterie alcaline AA (non incluse). Distanza raggio fino a 111 m. Certificata IP67. **Atex II 1 G Ex ia op is IIC T3 G.** Lumen 120.

TNI414 - torcia ATEX a led con magnete, lunghezza 159 mm, peso gr 116 gr con batterie

2 TORCIA LED RICARICABILE DUAL LIGHT™ CON MAGNETE



Torcia ATEX ricaricabile con magnete integrato all'estremità per posizionarla lasciando le mani libere. Proiettore a fascio largo, 2 interruttori per gestire il sistema a doppio led: fascio luce in avanti e verso il basso in prossimità dell'operatore (utilizzabili alternati o contemporaneamente). Autonomia 10 ore (high - 400 lumen) 19 ore (medium - 170 Lumen) 41 ore (low - 80 Lumen). Funzionamento con batteria ricaricabile al litio. Distanza raggio 215 m. Certificata IP67. **Atex II 1 G Ex ia IIC T4 Ga.** Lumen 400.

TNI542 - torcia ATEX a led con magnete, lunghezza 241 mm, peso gr 309 con batteria



3



3 TORCIA LED RICARICABILE CON TESTA RUOTABILE 90°



Torcia ATEX ricaricabile. Autonomia 7 ore (high - 200 lumen) 15 ore (medium - 110 Lumen) 27 ore (low - 60 Lumen). Funzionamento con batterie ricaricabili al litio, fornita con base di ricarica. La testa ruota di 90° - dirigendo il raggio esattamente dove è più necessario. La clip e l'anello a V tengono saldamente in qualsiasi situazione. Distanza raggio fino a 401 m (high). Certificata IP67. **Atex II 1 G Ex ia op is IIC T3 Ga.**

TNI568 - torcia ATEX a led ricaricabile, lunghezza 168 mm, peso gr 301 con batterie, Lumen 200



1 LAMPADA LED RICARICABILE



Potente lampada ATEX ricaricabile con 4 LED separati alloggiati in una testa inclinabile fino a 180 gradi. È in grado di generare fino a 1750 lumen ad alta intensità (autonomia 5 ore) o 600 lumen a bassa intensità (autonomia 11,5 ore). In nylon rinforzato con vetro, batteria Li-ion integrata ricaricabile. Base di ricarica, caricabatterie, cavo di ricarica a filo diretto e tracolla inclusi. Luci LED verdi posteriori. Certificata IP67. Lumen 1750.

TNI582 - lampada ATEX, dimensioni 190 x 110 x 150 mm, peso 1,2 kg con batterie

2 LAMPADA LED DUAL LIGHT™



Lampada ATEX ricaricabile con due interruttori per gestire il sistema Dual Light™. Autonomia 12,5 ore (alta, 210 lumen) 19,5 ore (media, 100 lumen) 65 ore (bassa, 30 lumen). Tempo di ricarica 6 ore. Batteria ricaricabile al litio inclusa. Caricatore da parete o da veicolo. Distanza raggio fino a 635 m (high). Certificata IP67. **Atex II 1 G Ex ia IIC T4 Ga**. Lumen 210.

TNI580 - lampada ATEX, lunghezza 203 mm, peso gr 935 con batterie



LAMPADA LED RICARICABILE



Lampada ATEX per illuminare grandi aree. Autonomia fino a 12 ore. Con magnete che consente di lavorare con le mani libere. Testa ruotabile di 360°. Modalità di illuminazione alta (1200 Lumen, 6 ore di autonomia) o bassa (650 Lumen, 12 ore di autonomia). Certificata IP67. **Atex II 1G Ex ia op is IIC T4 Ga**.

3 TNI700 - lampada ricaricabile a led ATEX con custodia

4 TNI700T - lampada TNI700 con custodia e treppiede da 1,8 mt



5 RALS 9440



Sistema di illuminazione a LED, illumina con rapidità spazi ristretti, confinati e argini. Batteria ricaricabile, attivazione Bluetooth da remoto, con controllo della luminosità variabile, tre livelli di potenza predefiniti, indicatore di livello della batteria. Tracolla regolabile per il trasporto inclusa. Altezza massima 2,13 m. Fascio luminoso 5300 lumen con apertura fascio luminoso di 125°. Illuminazione continua fino a 8 ore.

TPE9440 - dimensione testa cm 20 x 20 x 8,9, dimensione aperta cm 216 x 91 x 91

6 RALS 9460



Potente sistema di illuminazione a LED con batteria ricaricabile. Racchiuso in robustissima valigia, maneggevole grazie alle ruote in poliuretano con cuscinetti in acciaio inox. Controllo intelligente della batteria per regolare l'intensità della luce. Versatile, dotato di due montanti telescopici (h. max 1,52 m) girevoli estensibili fino a circa 1,83 m e di due luci con rotazione a 360°. Interruttori stagni individuali, fascio luminoso 12.000 lumen, illuminazione continua da 7 a 40 ore.

TPE9460 - dimensione testa cm 16,5 x 20 x 6,5, dimensione chiusa cm 56 x 35 x 23



ARMADI A PAVIMENTO A 2 ANTE

Armadi verniciati colore rosso. Tre ripiani con portata kg 100 ciascuno, capacità lt 763, peso senza imballo kg 83. Dimensioni: mm 1075 x 500 x 1850 h. Ingombro imballato: mm 1860 x 420 x 700.

- 1 ARR1854** - armadio 2 ante finestrate + 3 ripiani
- 2 ARR1857** - armadio 2 ante cieche + 3 ripiani
- 3 ARR1852** - armadio 2 ante cieche + 3 ripiani e appendiabito



ARMADI A PAVIMENTO A 2 ANTE

Armadi verniciati colore rosso. Tre ripiani con portata kg 100 ciascuno, capacità lt 763, peso senza imballo kg 83. Dimensioni: mm 1075 x 500 x 1850 h. Ingombro imballato: mm 1860 x 420 x 700.

- 4 ARR1855** - armadio 1 anta finestrata + 1 anta cieca + 3 ripiani e appendiabito
- 5 ARR1856** - armadio 2 ante finestrate + 3 ripiani e appendiabito
- ARR1859** - armadio 2 ante finestrate + 2 ripiani e appendiabito
- 6 ARR1858** - armadio 2 ante cieche + 2 ripiani e appendiabito
- LCV001** - lastra di ricambio Safe Crash mm 295 x 1500, per armadi ARR1854, ARR1855, ARR1856 e ARR1859



ARMADI PER ATTREZZATURE ANTINCENDIO



ARMADI A PAVIMENTO A 1 ANTA

Armadi verniciati colore rosso. Tre ripiani con portata kg 100 ciascuno, capacità lt 371, peso senza imballo kg 54. Disponibile kit appendiabiti per trasformare l'armadio in portatili. Dimensioni: mm 575 x 500 x 1850 h. Ingombro imballato: mm 1860 x 280 x 700.

- 1 ARR1850** - 1 anta cieca + 3 ripiani
- 2 ARR1851** - 1 anta finestrata + 3 ripiani
- LCV001** - lastra di ricambio Safe Crash mm 295 x 1500

ARMADI A PAVIMENTO A 1 ANTA

Armadi verniciati colore rosso, due ripiani con portata kg 100 ciascuno, capacità lt 215, peso senza imballo kg 33. Predisposti per aggancio a parete. Dimensioni: mm 575 x 500 x 1100 h. Ingombro imballato: mm 1120 x 280 x 600.

- 3 ARR1051** - 1 anta finestrata + 2 ripiani
- LCV002** - lastra di ricambio Safe Crash mm 290 x 780
- 4 ARR1050** - 1 anta cieca + 2 ripiani



ARMADI A PAVIMENTO A 2 ANTE

Armadio verniciato colore rosso, due ripiani con portata kg 100 ciascuno, capacità lt 403, peso senza imballo kg 53. Dimensioni: mm 1075 x 500 x 1100 h. Ingombro imballato: mm 1120 x 420 x 700.

- 5 ARR1052** - armadio a pavimento con 2 ante cieche e 2 ripiani
- 6 ARR1054** - armadio a pavimento con 2 ante finestate e 2 ripiani
- 7 ARR1053** - armadio a pavimento con 1 anta finestrata, 1 cieca e 2 ripiani
- LCV002** - lastra di ricambio Safe Crash, dimensioni mm 290 x 780 per ARR1053 e ARR1054



ARMADI PER ATTREZZATURE ANTINCENDIO



ARMADIO MONOBLOCCO



ARMADIO COMPONIBILE

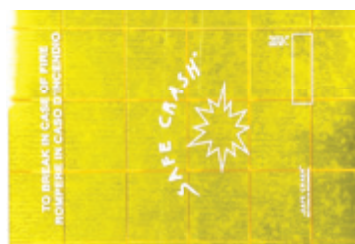

3

ESEMPI DI DOTAZIONE ANTINCENDIO PER ARMADI ARA1005 E ARA1007

- **FAP2197** - ascia piccola
- **ELE25** - elmetto in polietilene (spec. colore)
- **APB305/APB312** - telaio + visiera per ELE25
- **RSD999** - maschera pieno facciale
- **RSD5812** - filtro A1 B2 E2 K1 HG CO NO P3
- **GA2040** - guanti anticalore aramidici
- **FAP126** - corda da m 20 in poliestere
- **BUK903** - kit Professional antiustione

ARMADIO A PARETE A 1 ANTA

Armadio verniciato colore rosso, un'anta finestrata e una serratura.

- 1 **ARA1006** - armadio monoblocco 3 ripiani, capacità lt 198. Peso kg 23,5, mm 730 x 400 x 1000 h. Ingombro imballato: mm 1010 x 105 x 309 h
- 2 **ARA1007** - armadio componibile 2 ripiani, capacità lt 290. Peso kg 26,5, mm 730 x 400 x 1000 h. Ingombro imballato: mm 1010 x 105 x 740 h
- 3 **LCV005** - lastra di ricambio Safe Crash mm 800 x 523



4



5



6



7

4 ARMADIO A PARETE A 2 ANTE

Armadio a due ante finestrate, una divisoria, due ripiani grandi, due ripiani piccoli e due serrature. Capacità lt 380. Peso kg 41,5. Dimensioni: mm 1000 x 400 x 1000 h. Ingombro imballato: mm 1010 x 160 x 730 h.

ARA1010 - armadio a parete a 2 ante finestrate, verniciato colore rosso

LCV005 - lastra di ricambio Safe Crash, dimensioni mm 800 x 523

LCV007 - lastra di ricambio Safe Crash, dimensioni mm 185 x 800

ESEMPI DI DOTAZIONE ANTINCENDIO PER ARMADIO ARA1010

- **BUK883** - kit coperta antiustione
- **ELV031Y** - elmo per VV.F.
- **FAP611** - badile pieghevole
- **FAP900** - ascia con lama e piccozza
- **GA2040** - guanti anticalore aramidici
- **RSD415** - cappuccio di fuga
- **TAX07** - giaccone in Metaaramidico
- **ZCH0004** - stivale Fireman (spec. misura)

5 ARMADIO A PARETE A 2 ANTE

Armadio a due ante finestrate, due ripiani e una serratura. Capacità lt 390. Peso kg 38,5. Dimensioni: mm 1000 x 400 x 1000 h. Ingombro imballato: mm 750 x 1005 x 200 h.

ARA1012 - armadio a due ante finestrate, verniciato colore rosso

LCV002 - lastra di ricambio Safe Crash, dimensioni mm 290 x 780

ESEMPI DI DOTAZIONE ANTINCENDIO PER ARMADIO ARA1012

- **BUK883** - kit coperta antiustione
- **ELE25** - elmetto in polietilene (spec. colore)
- **APB305/APB312** - telaio + visiera per ELE25
- **FAP401** - piccozzino con custodia
- **FAP421** - corda in Kevlar da 20 metri
- **GA2040** - guanti anticalore aramidici
- **EOKF06** - estintore polvere portatile da kg 6
- **RSD685** - autorespiratore

A RICHIESTA FORNIBILI CON ALTRE DOTAZIONI.

ARMADI A PARETE A 1 ANTA

Armadietti verniciati colore rosso. Capacità lt 60, peso senza imballo kg 7,5. Predisposti per aggancio a parete. Dimensioni: mm 415 x 300 x 600 h. Ingombro imballato: mm 100 x 500 x 600.

6 **ARR0600** - 1 anta cieca + 1 ripiano fisso, 2 ganci

7 **ARR0601** - 1 anta finestrata, 4 ganci
LCV006 - lastra di ricambio Safe Crash mm 485 x 250



Indumenti di protezione dal calore alluminizzati

Morbidi e confortevoli, ideali per industrie del vetro, alluminio, acciaio e fonderie. Protezione al calore superiore a 1000° C. A norma EN ISO 11612:2015 A1 - B1 - C3 - D3 - E3 - F1 - III^A categoria.



1 GIACCA



Chiusura centrale con velcro, collo con bottone a pressione. Peso 260 g/m².

JTC080KA. - giacca, taglie fornibili: dalla M alla XL

2 PANTALONI



Chiusura centrale con velcro, bottone a pressione e passanti. Peso 260 g/m².

JCT100KA. - pantaloni lunghezza 100 cm, taglie fornibili: dalla 48 alla 58

3 CALZARI



Protezione ottimale del piede dal calore radiante. Facili da indossare, chiusura con velcro. Peso 400 g/m². Taglia unica.

JCT036H - calzari, altezza 36 cm

4 GREMBIULE



Semplice protezione dal calore radiante. Peso 260g/m². Taglia unica.

JCT1008 - grembiule, dimensioni 100 x 80 cm

5 CAPPOTTA



Chiusura centrale con velcro, collo con bottone a pressione isolato. Peso 260g/m².

JTC120KA. - cappotta lunghezza 120 cm, taglie fornibili: dalla 48 alla 54

6 CAPPUCCIO



Con ampia visiera frontale dorata per protezione dal calore radiante. Peso 260 g/m².

JTC000KAPCG - cappuccio, dimensioni 100 x 80 cm, taglia unica



ALTRI INDUMENTI ALLUMINIZZATI A PAGINA 382.

Coperte antifiamma

Realizzate in tessuto di fibra di vetro che non brucia, non si sfilaccia, non lascia depositi e non è tossico.



COPERTE ANTIFIAMMA

In fibra di vetro greggio incombustibile classe "0". Temperatura max continua per il tessuto greggio in assenza di stress meccanici: 540 °C, spessore mm 0,40 (+/- 10%), peso 420 gr/m² (+/- 10%). Fornite in custodia morbida in PVC o in custodia rigida.

7 Coperte in custodia morbida:

- FBA1015** - coperta cm 100 x 150
- FBA1020** - coperta cm 100 x 200
- FBA1212** - coperta cm 120 x 120
- FBA1220** - coperta cm 120 x 200
- FBA1520** - coperta cm 150 x 200
- FBA2020** - coperta cm 200 x 200

8 Coperte in custodia rigida:

- FBR1015** - coperta cm 100 x 150
- FBR1020** - coperta cm 100 x 200
- FBR1212** - coperta cm 120 x 120
- FBR1220** - coperta m 120 x 200
- FBR1520** - coperta cm 150 x 200
- FBR1818** - coperta cm 180 x 180

9 COPERTE ANTIFIAMMA EN1869

Estingue piccoli fuochi innescati da idrocarburi o focolai derivati da olii che raggiungono alte temperature. Tessuto impermeabile all'olio bollente e ai vapori, in fibra di vetro spalmato con resina su due lati. Peso 260 gr/m² (+/- 10%), spessore mm 0,24 (+/- 10%). Certificate EN1869.

FBEN1218 - coperta in cartone rigido, cm 120 x 180

FBEN1215 - coperta in cartone rigido, cm 120 x 150

FBEN1818 - coperta in cartone rigido, cm 180 x 180



COPERTA ANTIUSTIONE E ISOTERMICA

10 BUK883 - kit coperta antifiamma/antiustione (ulteriori caratteristiche a pagina 448)

11 BRB103 - coperta isotermica, dimensioni cm 160 x 210 (ulteriori caratteristiche a pagina 445)



GESTIONE SOSTANZE PERICOLOSE E INFIAMMABILI

VASCHE DI CONTENIMENTO PER FUSTI.....	482-486
VASCHE MOBILI, IMPILABILI E VASSOI DI CONTENIMENTO	485
CONTENITORE PER FUSTI OVER-DRUM.....	486
VASCHE DI CONTENIMENTO PER CISTERNETTE	487
SCAFFALATURE PER CISTERNETTE.....	488
DEPOSITI DI STOCCAGGIO	489,491-493
SUPPORTI PER FUSTI E PAVIMENTAZIONE IN ACCIAIO.....	490
DEPOSITI E ARTICOLI PER LA MOVIMENTAZIONE DI BOMBOLE A GAS.....	491
ARTICOLI PER STOCCAGGIO RIFIUTI AMIANTO.....	494-495
CONTENITORI PER ROTTAMI E NAVETTA PER MANUTENZIONE AEREA	496-497
CONTENITORI PER RIFIUTI SPECIALI	498
ARMADI PER STOCCAGGIO	498-501
ARMADI PER LIQUIDI INFIAMMABILI	500
STOCCAGGIO LIQUIDI INFIAMMABILI.....	501-504
VASCHE DI CONTENIMENTO PIEGHEVOLI.....	504
ACCESSORI E POSACENERI AUTOESTINGUENTI	505
PRODOTTI ASSORBENTI PER ACIDO SOLFORICO.....	506
BARRIERE CONTRO GLI ALLAGAMENTI.....	507
PRODOTTI ASSORBENTI PER SVERSAMENTI ACCIDENTALI SAFE IN®.....	508-514
PRODOTTI ASSORBENTI PER SVERSAMENTI ACCIDENTALI	515-516

A COSA SERVONO LE VASCHE DI RACCOLTA?



Proteggono le falde acquifere in caso di sversamenti accidentali di sostanze pericolose ed inquinanti. La vasca di raccolta deve avere un volume, ai fini normativi: di capacità minima pari al più grande dei contenitori stoccati e non inferiore ad 1/3 del volume totale stoccato. Qualora lo stoccaggio delle sostanze si trovasse in una zona di tutela della falda idrica, tutto il volume stoccato deve poter essere contenuto nella vasca di raccolta (100%).

CLIENTELA INTERNAZIONALE

Le disposizioni normative circa il volume di raccolta potrebbero cambiare nei diversi stati Europei ed Extraeuropei. Vi suggeriamo pertanto di verificare con le autorità competenti tali regolamentazioni per verificarne la conformità e sviluppare soluzioni dedicate.

COMPATIBILITÀ E MATERIALI COSTRUTTIVI

I materiali di cui è costituita la vasca devono essere compatibili con i prodotti che verranno stoccati. Per lo stoccaggio dei principali prodotti chimici si possono utilizzare vasche di contenimento in acciaio (FE360). Nel caso invece di prodotti o sostanze corrosive, quali acidi/basi ad esempio, si dovranno utilizzare delle vasche specifiche realizzate in polietilene. Se non vi sono indicazioni particolari nelle tabelle di resistenza, il materiale delle vasche può essere uguale al contenitore di stoccaggio della sostanza.

TUTELA DELLE ACQUE

D. Lgs. 11 maggio 1999, n. 152 - testo vigente. Testo aggiornato e coordinato con le modifiche introdotte dal D. Lgs 18 agosto 2000, n. 258 recante "Disposizioni correttive e integrative del Decreto Legislativo 11 maggio 1999, n. 152, in materia di tutela delle acque dall'inquinamento, a norma dell'articolo 1, comma 4, della legge 24 aprile 1998, n.128". (Supplemento ordinario n. 153/L alla G.U. 18 settembre 2000, n.218).

COME SI CALCOLA LA GIUSTA CAPIENZA DELLE VASCHE DI CONTENIMENTO?

Gli assorbenti industriali sono ideali per l'assorbimento di sversamenti o perdite accidentali di liquidi potenzialmente pericolosi quali: oli, refrigeranti, idrocarburi, sostanze chimiche etc... che potrebbero causare inquinamento del terreno e delle falde acquifere. La legge dice che i bacini di contenimento devono avere una capacità minima pari al più grande dei contenitori stoccati e non inferiori ad 1/3 del volume stoccato. Qualora lo stoccaggio delle sostanze si trovasse in una zona di tutela della falda idrica, tutto il volume stoccato deve poter essere contenuto nella vasca di raccolta (100%).

ESEMPI DI VOLUMI STOCCATI

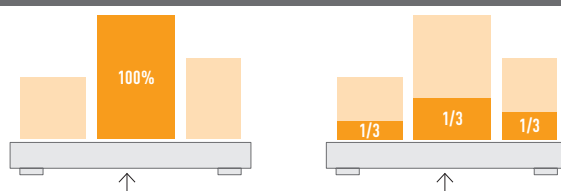

Ogni singolo caso dovrà attenersi alle disposizioni di legge locali in vigore

CALCOLO DELLA CAPIENZA*

ESEMPIO N°1

Totale delle sostanze stoccate: 1800 litri (1/3 di 1800 lt = 600 lt.) La capacità del contenitore più grande stoccato è di 1000 litri. **1000 è maggiore di 600.** Quindi per legge la vasca dovrà contenere **MINIMO 1000 LITRI.**

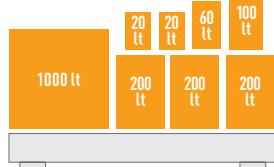

ESEMPIO N°2

Totale delle sostanze stoccate: 4500 litri (1/3 di 4500 lt = 1500 lt) La capacità del contenitore più grande stoccato è di 1000 litri. **1500 è maggiore di 1000.** Quindi per legge la vasca dovrà contenere **MINIMO 1500 LITRI.**

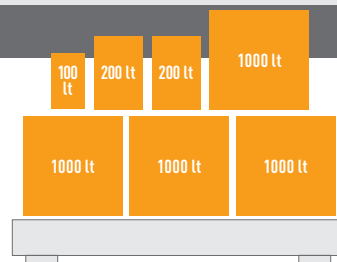

* Per il contenimento dell'olio esausto questa regola non vale. La legge impone che il contenimento della vasca sia uguale al totale dell'olio stoccato.

Pallet con vasca di raccolta

Costruiti in lamiera d'acciaio FE37 secondo UNI7070 con finitura zincata o verniciata. Idonei per lo stoccaggio di fusti e fustini da 200 e 60 litri, sia in verticale che in orizzontale, con l'ausilio dei supporti PS0901, PS0902 e PS0903. Dimensionati nel rispetto della normativa vigente (ideali per industria chimica).



1 PALLET BASIS BE

Vasca di raccolta con piano in grigliato zincato e piedi inforcabili. Capacità: 4 fusti verticali. **Volume di raccolta 270 lt.**

PS2204 - lamiera zincata mm 2470 x 815 x 250

PS2244 - lamiera verniciata mm 2470 x 815 x 250



2 PALLET BASIS BC

Vasca di raccolta con piano in grigliato zincato e piedi inforcabili. Capacità: 8 fusti verticali. **Volume di raccolta 540 lt.**

PS2208 - lamiera zincata. Dimensioni: mm 2460 x 1210 x 290

PS2248 - lamiera verniciata. Dimensioni: mm 2460 x 1210 x 290



Vasche di raccolta in acciaio zincato

Vasche di raccolta serie BASIC per lo stoccaggio di fusti da 200 Lt e piccoli contenitori in lamiera di acciaio zincato. Grigliato zincato asportabile.



i VASCHE ZINCATE DALLA FORMA CONICA, POSSONO ESSERE INSERITE L'UNA NELL'ALTRA, CON UNA SENSIBILE RIDUZIONE DELL'INGOMBRO.

Vasche di raccolta in acciaio verniciato

Vasche di raccolta serie TOP per lo stoccaggio di fusti da 200 Lt e piccoli contenitori in lamiera di acciaio verniciato. Grigliato zincato asportabile.



- 1 PSA101** - vasca conica in acciaio zincato con grigliato mm 800 x 800 x 450, capacità stoccaggio 1 fusto da 200 Lt. **Volume di raccolta 205 lt.**
- 2 PSA102** - vasca conica in acciaio zincato con grigliato mm 1200 x 800 x 340, capacità stoccaggio 2 fusti da 200 Lt. **Volume di raccolta 214 lt.**
- 3 PSA104** - vasca conica in acciaio zincato con grigliato mm 1200 x 1200 x 300, capacità stoccaggio 4 fusti da 200 Lt. **Volume di raccolta 270 lt.**
- 4 PSA301** - vasca in acciaio verniciato con grigliato mm 860 x 860 x 430, capacità di stoccaggio 1 fusto da 200 Lt. **Volume di raccolta 206 lt.**
- 5 PSA302** - vasca in acciaio verniciato con grigliato mm 1340 x 850 x 330, capacità di stoccaggio 2 fusti da 200 Lt direttamente su grigliato o su europallet mm 1200 x 800. **Volume di raccolta 216 lt.**
- 6 PSA304** - vasca in acciaio verniciato con grigliato mm 1340 x 1250 x 300, capacità di stoccaggio 4 fusti da 200 Lt direttamente su grigliato o su pallet mm 1200 x 1200. **Volume di raccolta 271 lt.**

PSA303 - vasca in acciaio verniciato con grigliato mm 2010 x 850 x 330, capacità di stoccaggio 3 fusti da 200 Lt

PSA305 - vasca in acciaio verniciato con grigliato mm 2660 x 850 x 330, capacità di stoccaggio 4 fusti da 200 Lt o 4 fusti su 2 europallet

PSA308 - vasca in acciaio verniciato con grigliato mm 2720 x 1250 x 300, capacità di stoccaggio 8 fusti da 200 Lt o 6 fusti su 3 europallet o 8 fusti su 2 pallet mm 1200 x 1200

Supporti per fusti

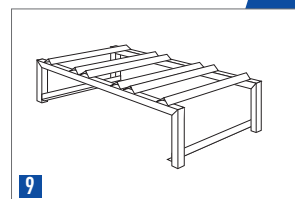
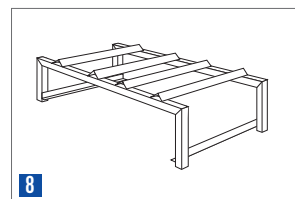
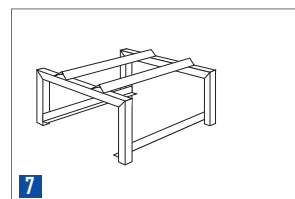

- 7 PSA451** - supporto dimensioni 600 x 600 x 380, per 1 fusto da 200 Lt
- 8 PSA452** - supporto dimensioni 1180 x 600 x 380, per 2 fusti da 200 Lt
- 9 PSA453** - supporto dimensioni 1180 x 600 x 380, per 3 fusti da 60 Lt



Vasche di contenimento in acciaio zincato

Le vasche di contenimento sono adatte alla raccolta di liquidi infiammabili (categorie GHS 1 - 3) e inquinanti per le acque (categorie GHS 1 - 4). Movimentabili tramite carrello elevatore o a mano (grazie al kit ruote + maniglie), possono presentare griglia o doghe zincate su cui posizionare fusti o cisterne. Le vasche di raccolta sono disponibili in versione conica o rettangolare: quest'ultimo modello è compatibile con il kit di accoppiamento che consente di collegare più vasche tra di loro per creare un sistema modulare di raccolta liquidi (fornibile a richiesta). L'uso di queste soluzioni di contenimento e di prevenzione degli sversamenti permette di rispondere alle diverse normative in materia di tutela ambientale e del luogo di lavoro (D.Lgs. N.152/2006 e D.Lgs. N.81/2008).

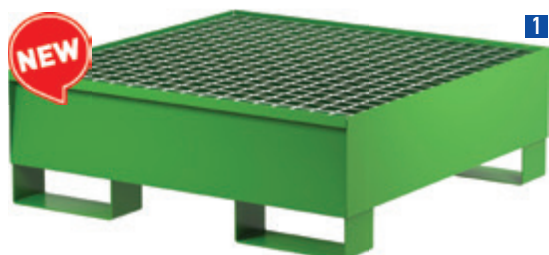

1 VASCA DI RACCOLTA PER 1 FUSTO

Vasca per 1 fusto da 200 litri. Impilabile e forconabile, verniciata a polvere colore verde RAL6018. Dimensioni: mm 960 x 960 x 332 h. Peso 47 kg.
COM101 - vasca di raccolta con griglia zincata, volume di raccolta 200 lt

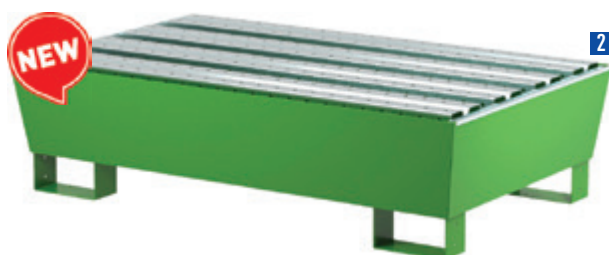

2 VASCA DI RACCOLTA CONICA PER 1 FUSTO

Vasca per 1 fusto da 200 litri. Impilabile e forconabile, verniciata a polvere colore verde RAL6018. Dimensioni: mm 1310 x 800 x 340 h. Peso 48 kg.
COM106 - vasca di raccolta con doghe zincate, volume di raccolta 200 lt



3 VASCA DI RACCOLTA MODULARE PER 2 FUSTI

Vasca per 2 fusti da 200 litri. Impilabile e forconabile, verniciata a polvere colore verde RAL6018. Dimensioni: mm 1300 x 800 x 392 h. Peso 59 kg.
COM102 - vasca di raccolta con doghe zincate, volume di raccolta 400 lt
COM103 - vasca di raccolta con griglia zincata, volume di raccolta 400 lt



4 VASCA DI RACCOLTA MODULARE PER 4 FUSTI

Vasca per 4 fusti da 300 litri. Impilabile e forconabile, verniciata a polvere colore verde RAL6018. Dimensioni: mm 1300 x 1200 x 392 h. Peso 80 kg.
COM104 - vasca di raccolta con doghe zincate, volume di raccolta 1200 lt
COM105 - vasca di raccolta con griglia zincata, volume di raccolta 1200 lt



5 VASCA DI RACCOLTA MODULARE DA 1000 LITRI

Vasca modulare da 1000 lt. Impilabile e forconabile, verniciata a polvere colore verde RAL6018. Dimensioni: mm 1600 x 1300 x 635 h. Peso 171 kg.
COM107 - vasca di raccolta con doghe zincate, volume di raccolta 1000 lt
COM108 - vasca di raccolta con griglia zincata, volume di raccolta 1000 lt



6 SUPPORTO INCLINATO SMONTABILE PER CISTERNA

Permette di porre una cisterna sopra una vasca di contenimento in posizione inclinata, per favorire le manovre di spillatura. Struttura metallica + doghe zincate, smontabile per occupare uno spazio ridotto. Portata 1000 kg.
COM109 - supporto inclinato mm 1300 x 1300 x 450 - 390 h, peso 26 kg



SUPPORTI PORTA FUSTI

Ideali per lo stoccaggio sicuro e stabile di fusti. Lo stoccaggio orizzontale del fusto facilita le operazioni di travaso e spillatura. Colore grigio RAL 7016.

- 7 COM110** - supporto per 1 fusto da 200 lt, dimensioni 1410 x 604 x 386 h
- 8 COM111** - supporto per 2 fusti da 200 lt, dimensioni 1366 x 604 x 386 h
- 9 COM112** - supporto sovrapponibile per 2 fusti da 200 lt o 3 fusti da 60 lt, dimensioni 1410 x 646 x 756 h





VASCHE MOBILI DI RACCOLTA IN ACCIAIO

Concepiti appositamente per le movimentazioni all'interno dell'azienda. Facile movimentazione grazie al maniglione di spinta e a 2 ruote fisse e a 2 piroettanti con freno. Consentono lo stoccaggio in verticale dei fusti e, con l'impiego dei supporti opzionali, anche in posizione orizzontale. Disponibile cinghia di trattenuta fusti con staffa di fissaggio per una maggiore sicurezza in fase di trasporto.

- 1 **PSA309** - vasca in acciaio verniciato mm 860 x 860 x 1170, capacità 1 fusto
- 2 **PSA310** - vasca in acciaio verniciato, mm 1340 x 850 x 1170, capacità 2 fusti. **Volume di raccolta 214 lt**
- 3 **PSA311** - vasca in acciaio zincato, mm 860 x 860 x 1170, capacità 1 fusto. **Volume di raccolta 206 lt**
- 4 **PSA312** - vasca in acciaio zincato mm 1340 x 850 x 1170, capacità 2 fusti
- 5 **PSA200** - kit di trattenuta fusti da 200 lt completo di staffa sagomata in lamiera zincata, cinghia, viti e dadi

6 VASCHE MOBILI DI RACCOLTA

In polietilene ecologico, 4 ruote girevoli, maniglione di spinta fornito di serie. Disponibile con grigliato o senza. Per contenitori max 60 lt. Resistenza ad acidi, basi, oli, ecc. Dimensioni: mm 795 x 645 x 1100 (con maniglione). **Volume di raccolta 60 lt.**

- PS7050** - vasca senza grigliato
- PS7151** - vasca con grigliato zincato



VASSOI DI CONTENIMENTO IN POLIETILENE

Pratici e resistenti vassoi in polietilene per lo stoccaggio di fusti, taniche e piccoli contenitori. Utili in caso di sostanze chimiche o corrosive grazie alla resistenza del polietilene. Versatili e leggeri, facilmente movimentabili quando vuoti. Dimensioni ottimizzate per l'utilizzo combinato su Europallet. Fornibili a richiesta modelli completi di grigliato in PE.

- 7 **PS3407** - vassoio, volume di raccolta lt 20, peso kg 2, dimensioni (l x p x h) mm 600 x 400 x 155
- 8 **PS3406** - vassoio, volume di raccolta lt 40, peso kg 3,5, dimensioni (l x p x h) mm 800 x 600 x 155

VERSIONE ZINCATA



9 VASCHE DI RACCOLTA IN POLIETILENE IMPILABILI

Elevata stabilità. Impilabili fino ad un massimo di 5 pezzi per stoccare e movimentare in sicurezza. Trasportabili in modo agevole con transpallet o con elevatore a forche. Le vasche sono utilizzabili anche per lo stoccaggio sicuro di batterie. Disponibili in 4 colori: grigio, blu, rosso, verde. Carico utile kg 500; carico impilabile kg 2500.

PS5805 - vasca in polietilene, volume di raccolta lt 240. Dimensioni (l x p x h) mm 1000 x 800 x 600

Colori: **R** rosso **B** blu **G** verde **S** grigio



STOCCAGGIO SOSTANZE PERICOLOSE



VASCHE DI CONTENIMENTO IN POLIETILENE PER FUSTI

Vasche di contenimento in polietilene per fusti da 200 Lt realizzate con stampaggio rotazionale. Grigliato zincato rimuovibile per una facile pulizia interna. Ideali per lo stoccaggio di acidi, soluzioni saline, oli, sostanze chimiche non infiammabili e altre sostanze compatibili con il polietilene. Sovrapponibili (rimuovendo il grigliato) e movimentabili con carrello elevatore o transpallet. Colore grigio antracite.

- 1 PSA111** - vasca in polietilene e grigliato zincato mm 925 x 755 x 555 h, **volume di raccolta 225 lt** (1 fusto)
- 2 PSA112** - vasca in polietilene e grigliato zincato mm 1270 x 700 x 430 h, **volume di raccolta 240 lt** (2 fusti)
- 3 PSA114** - vasca in polietilene e grigliato zincato 1270 x 1270 x 405, **volume di raccolta 450 lt** (4 fusti)

VASCHE DI CONTENIMENTO IN POLIETILENE PER FUSTI

Vasca movimentabile con carrello elevatore o transpallet grazie agli appositi alloggiamenti per le forche ricavati dalla sagomatura del fondo. Protezione assoluta contro la corrosione grazie alla realizzazione in polietilene. Ampia superficie di appoggio ideale per fusti e piccoli contenitori. Ideali per lo stoccaggio di diversi acidi, soluzioni alcaline, oli, sostanze chimiche non infiammabili e di molte altre sostanze compatibili con il polietilene.

- 4 PSA306** - vasca e grigliato in polietilene mm 1418 x 1018 x 515, **volume di raccolta 370 lt** (2 fusti), portata 665 kg
- 5 PSA307** - vasca e grigliato in polietilene mm 1418 x 1418 x 515, **volume di raccolta 590 lt** (4 fusti), portata 1000 kg



VASCHE DI RACCOLTA PER TRANSPALLET

Vasche di raccolta in polietilene per fusti verticali da 200 litri con tasche integrate per transpallet o carrello elevatore a forche. Alta resistenza contro oli, acidi, soluzioni alcaline ed altre sostanze aggressive. Dimensioni: mm 1300 x 900 x 375 h. **Volume di raccolta 270 lt. Portata tot. 600 kg.** Con omologazione generale n. Z-40.22.421.

- 6 PS5412** - solo vasca di raccolta
- 7 PS7495** - vasca con grigliato zincato
- 8 PS2286** - vasca con grigliato in polietilene

OVER-DRUM

Utilizzato per la gestione e movimentazione di fusti da 200 Lt danneggiati o deformati. In polietilene resistente a prodotti chimici pericolosi, compresi acidi, sostanze caustiche o corrosive. Coperchio, munito di guarnizione, si avvia facilmente e saldamente al fusto e non necessita di attrezzi per la sua chiusura o apertura. Utilizzato anche come secondo contenitore. **Settori di impiego:** industrie chimiche, farmaceutiche, elettroniche, della carta, aziende addette al recupero, stoccaggio e smaltimento di rifiuti pericolosi, Vigili del Fuoco e imprese di trasporto. **Dimensioni e caratteristiche:** altezza interna cm 107; Ø interno di base cm 65; Ø interno della bocca cm 70; spessori pareti cm 0,65; altezza esterna cm 114; Ø esterno massimo cm 80; peso kg 21,5; capacità: lt 365.

- 9 OVERDRUM** - contenitore ermetico da 365 Lt
- 10 PS0256** - pinza per sollevamento verticale di fusti da 200 Lt. Portata kg 300



1 VASCA DI RACCOLTA CON TETTOIA

Vasca in acciaio, piano di stoccaggio costituito da grigliati pressati, ribordati e zincati a caldo estraibili (portata 1000 kg/mq). Struttura del tetto zincata a caldo e sporgente con inclinazione posteriore per scarico acqua. 4 montanti zincati a caldo e bullonati alla struttura. **Volume di raccolta 1000 litri.**

PSA350 - vasca con tettoia per stoccaggio 1 cisternetta da 1000 lt, 2040 x 2000 x 2262 mm (base mm 1460 x 1647)



2 VASCHE DI RACCOLTA IN POLIETILENE PER CISTERNETTE

Per cisternette da 1000 litri, supporto interno rimovibile. In polietilene, movimentazione tramite carrello elevatore grazie alla particolare sagomatura del fondo. Larga base di appoggio, solida costruzione, forma ribassata. Ideali per lo stoccaggio di diversi liquidi, acidi, soluzioni alcaline, oli e sostanze chimiche non infiammabili compatibili con il polietilene.

PSA330 - vasca, volume di raccolta 1080 lt, dimensioni: mm 1585 x 1530 x 730 h



3 CISTERNETTA DA 1000 LITRI

Cisternetta in polietilene, pallet in acciaio zincato e plastica. Apertura di carico (tappo coperchio) Ø mm 150.

PS1120 - cisternetta da 1000 lt, dimensioni: mm 1000 x 1200 x 1180



VASCHE DI CONTENIMENTO IN POLIETILENE PER CISTERNETTE

Vasche di raccolta movimentabili con carrello elevatore o transpallet grazie agli appositi alloggiamenti per le forche ricavati dalla sagomatura del fondo. In polietilene ecologico anticorrosione, ampia superficie d'appoggio, ideale per deporre cisternette da 1000 litri. Ideali per lo stoccaggio di acidi, soluzioni alcaline, oli, sostanze chimiche non infiammabili e di molte altre sostanze compatibili con il polietilene.

4 PSA313 - capacità 1 cisternetta, dimensioni: mm 1418 x 1418 x 985 h, volume di raccolta 1150 lt, portata 1500 kg

5 PSA320 - capacità 2 cisternette, dimensioni: mm 2380 x 1418 x 748 h, volume di raccolta 1400 lt, portata 2500 kg

6 PSA319 - vaschetta spillaggio per vasche per cisternette

7 PSA318 - supporto per vaschetta spillaggio PSA319





SCAFFALATURE PER CISTERNETTE

Fornita smontata, di grande flessibilità per lo stoccaggio di cisternette da 1000 lt. Struttura a incastro, di elevata stabilità e facile montaggio. Ideale per sostanze pericolose, tossiche, nocive o infiammabili. Fornita con pareti in lamiera paraspruzzi. Ripiani per stoccaggio regolabili in altezza. Vasca di raccolta alla base con grigliato zincato. Pannelli monitori e targhetta di identificazione - costruzione in accordo alla norma UNI EN ISO 3834-3:2006.

- 1 PSA326** - scaffalatura, capacità 2 cisternette da 1000 lt, dimensioni spalla 3000 x 1430 mm (h x p) traverse lunghezza 1500 mm, vasca 1440 x 1340 x 550 mm + 100 piede. Volume di raccolta 1060 lt
- 2 PSA325** - scaffalatura, capacità 4 cisternette da 1000 lt, dimensioni spalla 3000 x 1430 mm (h x p) traverse lunghezza 2700 mm, vasca 2665 x 1340 x 500 mm + 100 piede. Volume di raccolta 1660 lt
- 3 PSA327** - scaffalatura, capacità 6 cisternette da 1000 lt, dimensioni spalla 3000 x 1430 mm (h x p) traverse lunghezza 3600 mm, vasca 3565 x 1340 x 470 mm + 100 piede. Volume di raccolta 2039 lt



4 VASCA DI CONTENIMENTO E STOCCAGGIO CON TETTOIA SMONTABILE

Pratica soluzione che consente di stoccare all'esterno la vasca di contenimento anche dove il fabbricato è sprovvisto di idonea copertura. Vasca in acciaio spessore 3 mm, verniciata in colore arancio RAL 2004, stoccaggio 2 cisternette da 1000 lt, grigliato zincato removibile (angolo frontale apribile per ispezione e pulizia della vasca senza rimuovere le cisternette). Tettoia in lamiera d'acciaio zincata a caldo, smontabile per facile trasporto e stoccaggio, montanti strutturali inseriti in apposite sedi, con blocco a bullone, all'esterno della vasca. **Volume di raccolta 1000 lt.**

PSA322 - dimensioni: mm 3500 x 1900 x 2110 h



5 VASCA DI CONTENIMENTO PER CISTERNETTE DA 1000 LT

Stazione di lavoro in acciaio 3 mm, verniciata in colore arancio RAL 2004, che permette di realizzare in sicurezza le operazioni di travaso, in quanto indirizza eventuali fuoriuscite di liquido direttamente nella vasca di raccolta. Ideata per lo stoccaggio di sostanze inquinanti. A richiesta applicabile apposito supporto inclinato che permette di eseguire facilmente travasi e dosaggi e di svuotare completamente la cisternetta. **Volume di raccolta 1000 lt.**

5 PSA323 - stazione, dimensioni: mm 2720 x 1315 x 420 h

6 PSA324 - supporto inclinato, dimensioni: mm 1250 x 1320 x 420/490 h

6 VASCHE DI RACCOLTA PER CISTERNETTE DA 1000 LT

Vasca di raccolta in acciaio 3 mm, verniciata in colore arancio RAL 2004, con grigliato. Fornibile in due versioni: con e senza supporto inclinato. Lo speciale grigliato diviso consente la collocazione del supporto inclinato, che permette di realizzare in sicurezza le operazioni di travaso. **Volume di raccolta 1000 lt.**

7 PSA314 - vasca senza supporto, dimensioni: mm 1340 x 1650 x 620 h

8 PSA315 - vasca con supporto, dimensioni vasca: mm 1340 x 1650 x 620 h, dimensioni supporto inclinato: mm 1250 x 1320 x 420/490 h



1 DEPOSITO PER ESTERNI PER FUSTI DA 200 LT

Deposito con capacità di stoccaggio per 4 fusti da 200 Lt direttamente su grigliato o su un pallet mm 1200 x 1200. Dotato di griglie di aerazione. Coperchio e porte robusti (possibilità di chiusura con lucchetto). Per facilitare le operazioni di carico e scarico il coperchio è sostenuto da ammortizzatori a gas.

PSA704 - deposito, dimensioni mm 1350 x 1260 x 1540

2 DEPOSITO PER ESTERNI PER PRODOTTI INFIAMMABILI

Deposito per utilizzo esterno e idoneo a sostanze pericolose e infiammabili da utilizzarsi per lo stoccaggio fino a 4 fusti da 200 Lt. Pareti laterali con prese d'aria a forma lamellare per garantire il necessario ricambio. Possibilità di chiusura con lucchetto.

PSA714 - deposito, dimensioni mm 1350 x 1260 x 1540



DEPOSITO DI STOCCAGGIO IN POLIETILENE PER FUSTI

Struttura monolitica senza saldature con **griglie di aerazione** sulle porte (apertura porte 180°). Tasche interne portadocumenti. Possibilità di ancoraggio al suolo tramite cavi fissati ad occhielli (opzionali) imbullonati. Chiusura a leva lucchettabile con maniglie (a richiesta con serratura). Pallet non fornito.

3 PSA1344 - deposito per 4 fusti da 200 Lt, dimensioni: mm 1540 x 1600 x 2000 h, volume di raccolta 470 Lt

4 PSA1342 - deposito per 2 fusti da 200 Lt, dimensioni: mm 1550 x 1000 x 1940 h, volume di raccolta 240 Lt

5 DEPOSITO DI STOCCAGGIO IN POLIETILENE PER CISTERNETTA

Solida costruzione monoblocco con forma ribassata in polietilene, **4 griglie di aerazione**, supporto interno rimovibile. Movimentazione tramite carrello elevatore grazie alla particolare sagomatura del fondo. Resistente ad acidi, basi, oli. Chiusura a leva lucchettabile con maniglie.

PSA1341 - capacità 1 cisternetta da 1000 Lt, dimensioni: mm 1540 x 1600 x 2350 h, volume di raccolta 1080 Lt

SISTEMI DI MOVIMENTAZIONE E TRASPORTO

6 PS0229 - carrello portafusti mm 640 x 560 x 1400 h, peso kg 26, ruote Ø mm 350. Per posizionare il fusto in orizzontale, comoda presa per fusti da 200 Lt con dispositivo di bloccaggio.

7 PSA899 - base circolare in lamiera verniciata per la movimentazione di fusti da 200 Lt. Con 4 ruote pivotanti Ø mm 100. Vasca antigocciolamento a tenuta stagna h mm 150. Peso kg 25

8 PSA898 - base circolare per la movimentazione di fusti in metallo e plastica da 200 Lt. Con 4 ruote pivotanti Ø mm 100, ideale per la movimentazione all'interno. Peso kg 12

9 PS0250 - chiave universale in acciaio per fusti

PS0251 - chiave universale come sopra in bronzo antiscintilla

10 PS0256 - pinza per sollevamento verticale di fusti da 200 Lt. Portata kg 300



1



3



2

2



4

4

SUPPORTI SOVRAPPONIBILI PER LO STOCCAGGIO DEI FUSTI IN ORIZZONTALE

Supporti sovrapponibili per lo stoccaggio di uno, due o tre fusti da 200 Lt in orizzontale e per tre fusti da 60 Lt. Ideali per facilitare le attività di picking.

- 1 PSA351** - supporto dimensioni mm 835 x 600 x 810, per 1 fusto da 200 Lt (da abbinare a vasca di raccolta PSA302)
- 2 PSA352** - supporto dimensioni mm 1335 x 600 x 810, per 2 fusti da 200 Lt (da abbinare a vasca di raccolta PSA302)
- 3 PSA353** - supporto dimensioni mm 1335 x 600 x 810, per 3 fusti da 60 Lt (da abbinare a vasca di raccolta PSA304)
- 4 PSA373** - supporto dimensioni mm 1962 x 600 x 810, per 3 fusti da 200 Lt (da abbinare a vasca di raccolta PSA308)

5 Sistema di pavimentazione in acciaio con vasca di raccolta

Utilizzabili anche con carrello elevatore, i sistemi di pavimentazione sono ideali per lo stoccaggio temporaneo e per la manipolazione di sostanze pericolose, tossiche, infiammabili e inquinanti. Trovano impiego nei depositi di vernici o solventi, nei depositi per vuoti o come protezione contro gli spruzzi e le perdite che possono manifestarsi durante le operazioni di travaso o scarico di sostanze inquinanti. **Fornibili a richiesta soluzioni personalizzate.**

VASTA GAMMA DI SOLUZIONI DISPONIBILI SU RICHIESTA.



5

ELEMENTO DI PAVIMENTAZIONE*

CODICE	DIMENSIONI (l x p x h)	VOLUME DI RACCOLTA
PS6101	1400 x 1400 x 53 mm	80 Lt
PS6102	1900 x 1400 x 53 mm	110 Lt
PS6103	2900 x 1400 x 53 mm	170 Lt
PS6104	2900 x 1900 x 53 mm	225 Lt

* Per tutti gli elementi di pavimentazione valgono le seguenti caratteristiche strutturali:

- portata: 5000 kg/m²
- portata max per ruota: 2000 kg

ELEMENTI DI FISSAGGIO

CODICE	DIMENSIONI (l x p)	ELEMENTI
PS6401	36 x 120 mm	Distanziatore
PS6402	28 x 90 mm	Fissaggio
PS6403	130 x 130 mm	Elemento a croce
PS6404	470 x 470 mm	Angolo

ELEMENTI DI GIUNZIONE

CODICE	DIMENSIONI (l x p)
PS6201	55 x 1360 mm
PS6202	55 x 1860 mm
PS6203	55 x 2860 mm

RAMPA D'ACCESSO

CODICE	DIMENSIONI (l x p)
PS6301	1380 x 470 mm
PS6302	1880 x 470 mm
PS6303	2880 x 470 mm

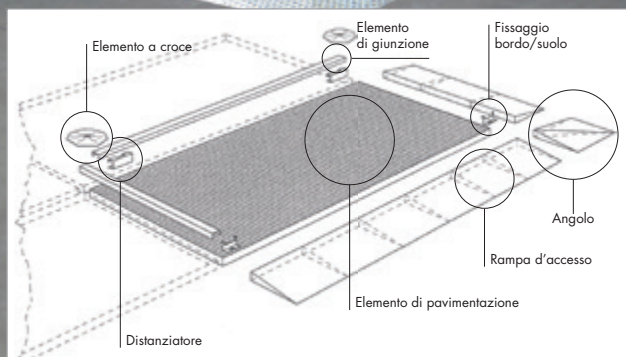
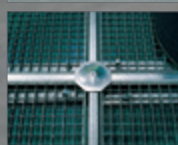
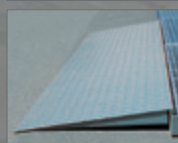



1

2



3

DEPOSITO PER BOMBOLE A GAS

Porta 2 battenti con chiusura antintrusione, tettuccio zinco, **basamento interno** in acciaio, aggancio bombole interno con catena e moschettone. Predisposto modularità. Segnaletica di sicurezza compresa.

- 1 PSA2455** - capacità 9/12 bombole, dimensioni mm 960 x 1130 x 2100 h.
- 2 PSA2455R** - rampa opzionale
- 3 PSA2455S** - ripiano rimovibile intermedio opzionale per stoccare bombole di piccole dimensioni



4 SUPPORTO A MURO PER BOMBOLE A GAS

Supporto a muro per bombole in acciaio zincato a caldo, di facile installazione, con catene di fissaggio per bombole Ø massimo mm 250.

PSA202 - supporto a muro per bombole a gas, dimensioni mm 860 x 60 x 115



5



6

7

DEPOSITO PER BOMBOLE AD UN BATTENTE

Dotati di porta battente con serratura, robustissimo telaio portante in acciaio zincato a caldo, predisposti per l'ancoraggio al suolo. Possibilità di scelta di apertura porte a destra o a sinistra. Suddivisione interna in corsie con catenelle di sicurezza.

- 5 PS8024 - modello senza basamento.** Capacità contenimento: 1 pallet da 12 bombole + 4 bombole o 24 bombole libere, senza cestello. Dimensioni del box montato: mm 1550 x 1210 x 2285 h. Peso kg 190. Fornito montato
- 6 PSA2450 - modello con basamento.** Capacità contenimento: 1 pallet da 12 bombole + 4 bombole o 24 bombole libere, senza cestello. Dimensioni del box montato: mm 1550 x 1210 x 2450 h. Peso kg 210. Fornito montato
- 7 PSA15** - rampa di accesso, dimensioni mm 1000 x 580 x 185 h



8



9

10

PALLET PER TRASPORTO DI BOMBOLE A GAS

Pallet per il trasporto di bombole a gas. Movimentabile con gru o carrello elevatore.

- 8 PS4312** - capacità 12 bombole da 50 lt. Dimensioni: mm 805 x 1030 x 1230 h. Con rampa ribaltabile
- 9 PS4310** - capacità 4 bombole da 50 lt. Dimensioni: mm 860 x 650 x 1115 h.
- 10 PS4311** - capacità 8 bombole da 50 lt. Dimensioni: mm 800 x 1170 x 1115 h.



11

12

CARRELLI TRASPORTO BOMBOLE A GAS

- 11 PS0207** - carrello in acciaio con ruote in gomma Ø mm 350, per trasporto 2 bombole di gas
- 12 PSA206** - carrello in acciaio con ruote in gomma Ø mm 200, per trasporto 1 bombola di gas



STOCCAGGIO SOSTANZE PERICOLOSE



1



2



3



4

VASTA GAMMA DI SOLUZIONI
DISPONIBILI SU RICHIESTA.

1 MODUL CONTAINER PER SOSTANZE INQUINANTI ED INFIAMMABILI PER PICCOLI CONTENITORI E FUSTI

Ideale quando, oltre a piccoli contenitori, si devono stoccare anche fusti da 200 litri. Superficie di circa 6 mq con volume di raccolta di 1000 litri. Per uno stoccaggio al riparo dal gelo è disponibile, a richiesta, la versione coibentata ed anche l'eventuale impianto di riscaldamento. Gli impianti di ventilazione sono previsti con interruttore principale in custodia IP 55, montati e cablati alla parete esterna del container.

PSA923A - modul container in acciaio zincato, dimensioni esterne mm 3150 x 2350 x 2365 h, volume di raccolta di 1000 litri

PSA923B - modul container in acciaio zincato e sovraverniciato colore blu, dimensioni esterne mm 3150 x 2350 x 2365 h, volume di raccolta di 1000 litri

2 MODUL CONTAINER PER STOCCAGGIO POLIVALENTE

Per esterni, può contenere 4 postazioni di cisternette da 1000 litri o pallet porta big bag. Piano di stoccaggio composto da grigliati zincati a caldo estraibili e vasca di raccolta capacità 1900 litri. Pareti laterali e posteriore, porte e tetto con profilo di acciaio zincato e rivestimenti in lamiera zincata. Piedini con piastre d'appoggio forate per ancoraggio al suolo (h 100 mm). Imbocchi in lamiera zincata per convogliare perdite nel bacino di raccolta. Movimentabile con carrello elevatore.

PSA700 - modul container polivalente, dimensioni esterne mm 5470 x 1710 x 2600 h, volume di raccolta di 1900 lt

MODUL CONTAINER PER SOSTANZE INQUINANTI ED INFIAMMABILI PER PICCOLI CONTENITORI

Soluzione compatta (2 m²), idonea per lo stoccaggio di sostanze pericolose in piccoli contenitori se ampliato con le scaffalature opzionali. Impianti di ventilazione previsti con interruttore principale in custodia IP55, montati e cablati alla parete esterna del container.

3 PSA912A - modul container in acciaio zincato, dimensioni esterne mm 2350 x 1150 x 2365 h, volume di raccolta di 300 litri

4 PSA912B - modul container in acciaio zincato e sovraverniciato colore blu, dimensioni esterne mm 2350 x 1150 x 2365 h, volume di raccolta di 300 litri

LE GRIGLIE DI VENTILAZIONE, RAFFIGURATE SUI MODELLI DI MODUL CONTAINER DI QUESTA PAGINA, SONO OBBLIGATORIE SE SI STOCCANO SOSTANZE INFIAMMABILI E DEVONO ESSERE ORDINATE SEPARATAMENTE. ESEMPIO: PSA912 + PSA001. IN CASO CONTRARIO I MODUL CONTAINER VENGONO CONSEGNATI SENZA LE GRIGLIE.



5

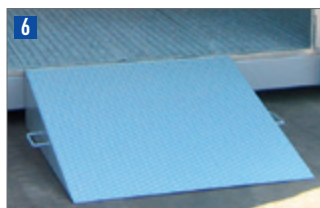

6



7



8

ACCESSORI ED EQUIPAGGIAMENTI PER MODUL CONTAINER

5 PSA001 - griglie di ventilazione opzionali per lo stoccaggio di materiale infiammabile con area di passaggio pari ad un trentesimo della superficie in pianta (Circolare del Ministero degli Interni n° 8 del 17/04/1985). Kit composto da: 2 griglie per porte anteriori + 1 griglia per parete posteriore in alto

PSA002 - tetto isolante opzionale in sandwich di lana minerale di 50 mm fra lamiere zincate (per modul container PSA912.)

PSA003 - tetto isolante opzionale in sandwich di lana minerale di 50 mm fra lamiere zincate (per modul container PSA923.)

6 PSA004 - rampa di accesso zincata mm 1000 x 960 x 280 h

7 PSA005 - scaffalatura per PSA912A e PSA912B, larghezza mm 1000 composta da tre ripiani grigliati della profondità di mm 500

PSA006 - scaffalatura per PSA923A e PSA923B, larghezza mm 2000 composta da tre ripiani grigliati della profondità di mm 500

8 PSA007 - illuminazione interna versione antideflagrante ex-d1 x 18W, 230 V con interruttore esterno



1



2

MODUL CONTAINER

Ideale per lo stoccaggio di sostanze inquinanti e infiammabili conservate in contenitori di diverse grandezze. Ottimo compromesso tra le esigenze di stoccaggio e di ingombro: la superficie in pianta è circa di 11 mq (volume di raccolta di 1700 litri). Posizionamento delle porte sul lato lungo.

1 PSA925A - modul container in acciaio zincato, dimensioni esterne mm 5150 x 2350 x 2365 h, volume di raccolta di 1700 litri

2 PSA925B - modul container in acciaio zincato sovraverniciato blu, dimensioni esterne mm 5150 x 2350 x 2365 h, volume di raccolta di 1700 litri



3

3 MODUL CONTAINER

Vasca di raccolta in acciaio verniciata e pavimento in grigliato zincato a caldo. Pareti laterali e tetto in pannelli sandwich classe A2 S1-d0 di lana minerale spessore 50 mm interposta tra lamiere zincate. Porta a 2 battenti e serratura a chiave. Verniciatura interna/esterna colore bianco con fondo epossidico e ciclo acrilico altossido a 2 componenti. Fornito montato e movimentabile con muletto dotato di prolungamento forche. Rampa d'accesso opzionale PSA004.

PSA923T - modul container coibentato, dimensioni esterne mm 3150 x 2350 x 2350 h, volume di raccolta 1000 litri

I CONTAINER SONO LA SOLUZIONE IDEALE DI STOCCAGGIO PER SOSTANZE INQUINANTI ED INFIAMMABILI CONSERVATE IN CONTENITORI DI DIVERSE GRANDEZZE. TUTTI I CONTAINER VENGONO FORNITI MONTATI.



5

VASTA GAMMA DI SOLUZIONI DISPONIBILI SU RICHIESTA.



6



4

DEPOSITO PER ESTERNI PER CISTERNETTE DA 1000 LT

Per stoccare all'esterno due cisternette da 1000 lt. Rivestimento esterno in lamiera zincata, gancio di sicurezza per bloccare la porta. Tetto isolante opzionale in pannelli sandwich da 50 mm di lana minerale rivestiti in lamiera zincata su entrambi i lati. Vasca di raccolta da 1000 lt. Piano di appoggio in grigliato zincato amovibile per la pulizia della vasca di raccolta. Porta con chiusura a chiave. Possibilità di rivestimento opzionale antiacido della vasca o realizzazione della stessa in acciaio inossidabile per sostanze corrosive.

4 PSA732A - deposito in lamiera zincata, dimensioni esterne mm 3000 x 1870 x 2390 h, profondità interna utile mm 1655

PSA732B - deposito in lamiera zincata e sovraverniciata colore blu, dimensioni esterne mm 3000 x 1870 x 2390 h, profondità interna utile mm 1655

PSA733 - griglie di ventilazione opzionali per lo stoccaggio di materiale infiammabile con area di passaggio pari ad un trentesimo della superficie in pianta (Circolare del Ministero degli Interni n° 8 del 17/04/1985). Kit composto da: 2 griglie per porte anteriori + 1 griglia per parete posteriore in alto

5 PSA734 - supporto inclinato



6 CONTAINER PER STOCCAGGIO FUSTI DA 200 LT

Per lo stoccaggio di fusti su pallet 800 x 1200 e 1200 x 1200 mm. Massima capacità di stoccaggio: 16 fusti su 4 pallet da mm 1200 x 1200, o 12 fusti su 6 pallet da mm 800 x 1200. Vasca di raccolta di capacità pari ad 1/3 del volume totale stoccabile.

PSA716A - container in lamiera zincata, dimensioni esterne mm 3150 x 1650 x 3000 h, volume di raccolta 1100 lt

PSA716B - container in lamiera zincata e sovraverniciata colore blu, dimensioni esterne mm 3150 x 1650 x 3000 h, volume di raccolta 1100 lt

PSA001 - griglie di ventilazione opzionali per lo stoccaggio di materiale infiammabile con area di passaggio pari ad un trentesimo della superficie in pianta (Circolare del Ministero degli Interni n° 8 del 17/04/1985)

PSA718 - tetto isolante opzionale in sandwich di lana minerale di 50 mm fra lamiere zincate



STOCCAGGIO RIFIUTI AMIANTO



DECRETO MINISTERO AMBIENTE E TUTELA TERRITORIO 03/08/2005
(Omologazione UN13H3Y; Trattato internazionale ADR - Accord Dangereuses par Route).

1 PALLET PORTA BIG BAG SMONTABILE

Sovrapponibile, in acciaio al carbonio zincato a caldo, fondo in rete con montanti sfilabili. Idoneo al contenimento di Big Bag da 1000 lt. Fornibile a richiesta pallet porta Big Bag con vasca di raccolta.

AMS1205 - pallet zincato, dimensioni mm 1070 x 1070 x 1350 h (fornito senza sacco Big Bag)

2 BIG BAG SACCO AMIANTO

Costruito in rafia polipropilenica da 140 gr/m², portata kg 750; S.F. 6:1. Fodera interna da 80 micron saldata alla base, fondo piatto e apertura totale a caramella con laminatura, altezza cm 70, tessuto da 160 gr/m². 4 bretelle per il sollevamento. Prodotto con marchiatura: "a" di amianto, "R" di rifiuto, simbolo del Trattato ADR classe 9. Tasca documenti formato A4 ed etichetta con istruzioni per l'uso. **Omologati UN13H3Y rifiuti diversi.**

AMS417 - Big Bag sacco amianto, dimensioni esterne cm 88 x 88 x 106 h, peso kg 2,28

3 SACCONI BIG BAG PER RIFIUTI DIVERSI

Contenitori flessibili in tessuto di rafia polipropilenica, adatti al trasporto e allo stoccaggio di svariati materiali: sfarinati, materiali ferrosi, concimi, granaglie, materiale edile. Apertura superiore a caramella, non omologati ONU (vedere modello AMS416). 4 bretelle di sollevamento e fondo chiuso. Fattore di sicurezza 5:1. Versione standard: completo di fodera in polietilene adatta a prodotti polverosi o parzialmente umidi. Versione eco: senza fodera interna per tutti gli altri prodotti.

AMS120 - sacco Big Bag, cm 90 x 90 x 120, versione standard con fodera, portata 1500 kg

AMS123 - sacco Big Bag, cm 90 x 90 x 120, versione senza fodera, portata 1500 kg



CONTENITORI PORTA BIG BAG CON VASCA

Struttura smontabile, dotato di vasca di sicurezza per liquidi a tenuta stagna, con grigliato zincato asportabile. Costruzione realizzata in acciaio al carbonio da 3 e 4 mm. 4 montanti sfilabili, cestello superiore porta Big Bag ad incastro nei 4 montanti sfilabili. Trattamento esterno anticorrosione ed etichettatura di sicurezza.

4 AMS130 - contenitore porta Big Bag con vasca mm 1000 x 1000 x 1860 h (fornito senza sacco Big Bag)

5 AMS135 - come sopra, con ruote



6 BIG BAG SACCO RIFIUTI

Big Bag utilizzato per il confezionamento dei rifiuti diversi derivanti dalle bonifiche. In rafia polipropilenica da 160 gr/m². Portata 1000 kg. Fodera interna in polietilene da 80 micron, altezza cm 260, fondo piatto e apertura totale. 4 bretelle per il sollevamento, tasca documenti, marchiatura "R". Trattato internazionale ADR. **Omologati UN13H3Y rifiuti diversi.**

AMS416 - Big Bag sacco, cm 90 x 90 x 120 h, peso kg 2,28



1 SACCHI IN RAFIA POLIPROPILENICA

Garantiscono maggiore sicurezza in presenza di pezzi contaminati taglienti o abrasivi. Dimensionati per successivo posizionamento nei sacchi regolamentari per contenere amianto.

AMS424 - sacchi in raffa polipropilenica, cm 70 x 120

2 SACCHI IN POLIETILENE

Omologati UN5H4Y (amianto). Sacchi regolamentari in polietilene e speciali additivi per migliorare la resistenza meccanica. Spessore mm 0,15. Marchiatura: "a" di amianto, "R" di rifiuto e simbolo del trattato ADR classe 9. D.M. 06/09/1994 Trattato internazionale ADR - Accord Dangereuses par Route.

AMS422 - sacchi polietilene, cm 70 x 130

NASTRI ADESIVI PER AMIANTO

3 NSA425 - nastro adesivo in polipropilene per imballo di rifiuti contenenti amianto con impressa la dicitura regolamentare "A - attenzione amianto...". Lunghezza rotolo m 66, altezza nastro mm 50, spessore 35 micron

4 NSA542 - nastro in polietilene con scritta "Attenzione pericolo amianto" impiegato per delimitare la zona di lavoro, colore giallo/nero. Lunghezza rotolo m 200, altezza nastro mm 70, spessore 0,1 mm

DPI raccomandati per movimentazione rifiuti amianto



5 TYV4 - tuta Tyvek Classic Plus. Taglie (EN): M - L - XL - XXL. A norma EN465 - EN468 Tipo 4-5-6

6 TYV6. - tuta Tyvek Classic Xpert. Taglie (EN): M - L - XL - XXL. Tipo 5 e 6

7 GERO99/. - guanti in nitrile senza polvere III categoria, monouso ambidestri, taglie EN (dalla S alla XXL), lunghezza mm 290

8 TYV17 - calzari in Tyvek con suola in PVC antiscivolo, laccetti di chiusura ed elastico al ginocchio, 100% polietilene 41 g/m². Misura: 34 cm. **Confezione da 10 paia**

9 AP9332 - facciale filtrante con valvola per polveri tossiche e fumi. Classe FFP3. A norma EN149:2001. Minimo ordinabile 10 pezzi/multipli

10 AP8148 - occhiali a mascherina, ventilazione indiretta, lente in policarbonato incolore antiappannante (1B 34 EN166)

11 ELE08W - elmetto Super Boss colore bianco, in polietilene alta densità. A norma EN397

Segnaletica per amianto



3564 - cartello in alluminio 200 x 300 mm, spessore 0,5 mm

3564S Segnale in pellicola autoadesiva 200 x 300 mm



9722 Etichetta singola 100 x 200 mm (minimo ordinabile 5 etichette/multipli)



9713 Foglio da 25 etichette 25 x 50 mm (minimo ordinabile 5 fogli/multipli)



E28301 Cartello in alluminio 652 x 833 mm, spessore 1 mm



E440102X Cartello in alluminio 360 x 450 mm, spessore 0,7 mm



E9576A Etichetta, foglio 250 x 175 mm (2 etichette per foglio)



9450C Etichetta 100 x 100 mm (minimo ordinabile 5 etichette/multipli)



9475F Etichetta 150 x 150 mm (minimo ordinabile 5 etichette/multipli)



CONTENITORI PER ROTTAMI



CONTENITORI RIBALTABILI PER ROTTAMI

Per la raccolta, la movimentazione e lo scarico di rifiuti, sfidri e rottami in sicurezza. Sistema di svuotamento semplice e sicuro mediante leva azionabile dall'operatore (senza scendere dal carrello elevatore). Maneggevoli e di facile posizionamento di lavoro grazie a 4 ruote di grande diametro (2 fisse - 2 piroettanti) montate su cuscinetti. Vasca a tenuta stagna, ideali per ogni tipo d'azienda. A richiesta (per alcuni modelli): vasca di decantazione e rubinetto a sfera, coperchio rimovibile o incernierato, cilindro idraulico autonomo per un graduale ribaltamento.

Colori: **S** grigio **Y** giallo **A** arancio **B** blu **G** verde

- 1 PSA300.** - contenitore ribaltabile per rottami, portata kg 600, volume 285 lt
- PSA500.** - contenitore ribaltabile per rottami, portata kg 1000, volume 490 lt
- PSA750.** - contenitore ribaltabile per rottami, portata kg 1350, volume 755 lt
- PSA1000.** - contenitore ribaltabile per rottami, portata kg 1700, volume 1070 lt
- PSA1350.** - contenitore ribaltabile per rottami, portata kg 2000, volume 1320 lt
- PSA1600.** - contenitore ribaltabile per rottami, portata kg 2000, volume 1610 lt
- 2 PSA2000.** - contenitore ribaltabile per rifiuti ingombranti, portata kg 2000, volume 2040 lt

DIMENSIONI CONTENITORI RIBALTABILI PORTAROTTAMI

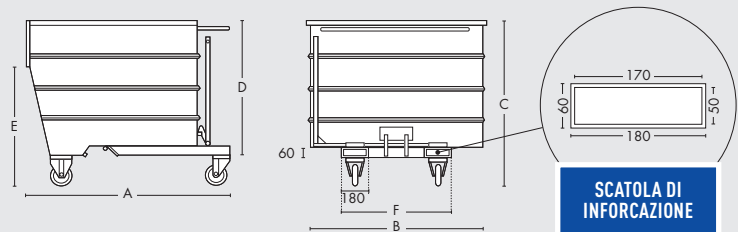

MODELLO	A	B	C	D	E	F	VOLUME	PORTATA
PSA300	1350	920	870	490	520	700	285 lt	600 kg
PSA500	1350	920	910	700	740	800	490 lt	1000 kg
PSA750	1350	1070	1040	825	800	800	755 lt	1350 kg
PSA1000	1550	1070	1210	970	920	800	1070 lt	1700 kg
PSA1350	1550	1320	1210	970	920	800	1320 lt	2000 kg
PSA1600	1550	1550	1210	970	920	800	1610 lt	2000 kg
PSA2000	1550	1950	1210	970	920	800	2040 lt	2000 kg

CONTENITORI RIBALTABILI PER ROTTAMI

Contenitori ribaltabili sia da terra che in sollevamento con carrello elevatore. Con 4 ruote, 2 fisse e 2 piroettanti Ø 175 mm e vasca a tenuta stagna. Colori: **A** arancio **G** verde

- 3 PSA460.** - contenitore ribaltabile per rottami, capacità kg 1000, volume 400 lt
- 4 PSA450.** - contenitore ribaltabile per rottami, capacità kg 1000, volume 438 lt
- 5 PSA470.** - contenitore ribaltabile per rottami, capacità kg 1000, volume 675 lt

DIMENSIONI CONTENITORI PORTAROTTAMI

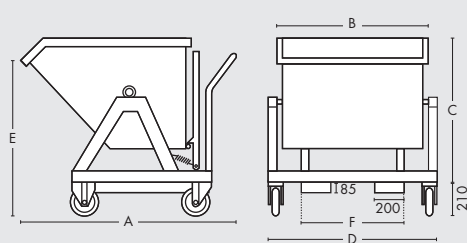

MODELLO	A	B	C	D	E	F
PSA450	1300	950	935	1070	1035	620
PSA460	1175	1000	830	1120	840	680
PSA470	1225	1135	1075	1260	1185	815



COLORI A RICHIESTA

- arancio (RAL 2004)
- blu (RAL 5010)
- azzurro (RAL 5012)
- verde scuro (RAL 6011)
- grigio (RAL 7000)



BENNE PORTA ROTTAMI

Ideali per la movimentazione rapida, ordinata e in sicurezza di rifiuti, rottami e scarti di produzione all'interno del luogo di lavoro. Le operazioni di svuotamento sono agevolate dal meccanismo che consente il ribaltamento della vasca, azione che l'operatore può svolgere anche senza scendere dal carrello. Lo spostamento della benna può avvenire a mano oppure tramite carrello elevatore o transpallet, grazie alla presenza di supporti forconabili nella parte inferiore del contenitore. Benne predisposte per l'installazione del pistone idraulico che consente di ammortizzare il ribaltamento della benna. **Colore verde RAL 6018 (altri colori fornibili a richiesta).** A norma UNI EN ISO 12100.

- 1 COM113G** - benna porta rottami 300 Lt colore verde, dimensioni mm 1300 x 780 x 670 h, fornita montata
- COM114G** - benna porta rottami come sopra, fornita smontata
- COM115G** - benna porta rottami 500 Lt colore verde, dimensioni mm 1410 x 800 x 973 h, fornita montata
- COM116G** - benna porta rottami come sopra, fornita smontata
- COM117G** - benna porta rottami 750 Lt colore verde, dimensioni mm 1400 x 1150 x 973 h, fornita montata
- COM118G** - benna porta rottami come sopra, fornita smontata
- COM119G** - benna porta rottami 1000 Lt colore verde, dimensioni mm 1500 x 1155 x 1133 h, fornita montata
- COM220G** - benna porta rottami come sopra, fornita smontata
- COM221G** - benna porta rottami 1350 Lt colore verde, dimensioni mm 1500 x 1495 x 1137 h, fornita montata
- COM222G** - benna porta rottami come sopra, fornita smontata
- 2 COM223** - pistone idraulico per benne

DIMENSIONI BENNE PORTAROTTAMI

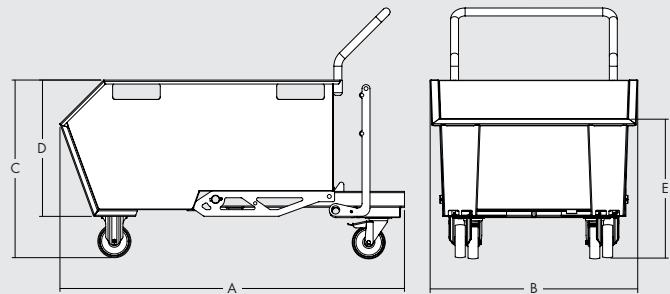

MODELLO	A	B	C	D	E	VOLUME	Ø RUOTE
COM113	1300	780	670	515	525	300 lt	125
COM115	1410	800	973	770	770	500 lt	160
COM117	1400	1150	973	770	770	750 lt	160
COM119	1500	1155	1133	930	880	1000 lt	160
COM121	1500	1495	1137	930	880	1350 lt	160

DIMENSIONI PSA163

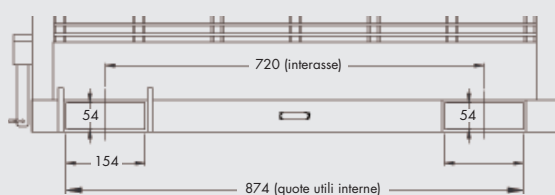

3 NAVETTA PER MANUTENZIONE AEREA

Per lavori di straordinaria manutenzione. Completo di sponda in rete a protezione dell'operatore (richiudibile), porta di accesso richiudibile automaticamente, piano in gomma di sicurezza antiscivolo e antistatico, vaschetta porta attrezzi in polistirene antiurto, dispositivo di sicurezza antisfilamento accidentale delle forche, attacchi per utilizzo di cinture di sicurezza (non comprese). Corredato di manuale d'uso e manutenzione, pannelli monitori a prevenzione dei rischi maggiori e targhetta metallica identificativa riportante i dati tecnici dell'attrezzatura. Dimensioni (l x p x h): mm 1000 x 1000 x 1100/2110.

PSA163 - navetta per manutenzione aerea



IDEALE PER EFFETTUARE TUTTI I LAVORI DI RIPARAZIONE E MANUTENZIONE AEREA IN PIENA SICUREZZA.





CONTENITORI PER RIFIUTI SPECIALI E ARMADI DI STOCCAGGIO



1



2

CONFORME AL D. LGS. 95/1992 E SUCCESSIVO 392/1996.



A



3



4



5

1 CONTENITORE PER TUBI AL NEON E FLUORESCENTI

Contenitore per la raccolta differenziata di tubi al neon e fluorescenti, **realizzato completamente in polietilene**, dotato di coperchio incernierato e richiudibile e di bisaccione flessibile interno asportabile. Base palletizzata per agevolare la movimentazione. Completo di asta reggi coperchio. Coperchio lucchettabile con catena di chiusura. Capacità 900 lt.

PSAC187 - contenitore in polietilene, dimensioni (l x p x h): mm 1870 x 920 x 1060

PSAC187R - ricambio bisaccione in tessuto di polipropilene

2 CONTENITORE PER LA RACCOLTA DI OLI ESAUSTI

Posizionabili all'aperto direttamente su comuni pavimentazioni, senza pericolo di infiltrazioni d'acqua. In polietilene ad alta densità molecolare stabilizzato UV, monolitico rotostampato 100% riciclabile. Composto da una vasca interna a contatto con l'olio e di una esterna di sicurezza e contenimento. Ampio boccaporto con coperchio ribaltabile, cestello scolafiltri (A) asportabile e vano per immissione ed estrazione olio esausto. Indicatore visivo di livello per **controllare la quantità di olio usato** contenuta e spia di verifica per il monitoraggio dell'intercapedine della vasca di contenimento.

PSAC260 - capacità 260 lt, altezza mm 1184 x Ø 810, coperchio mm 500 x 300. **Facile movimentazione con transpallet** o carrello elevatore

PSAC500 - capacità 500 lt, altezza mm 1370 x Ø 980, coperchio mm 500 x 300

3 CONTENITORE PER PILE ESAUSTE

Per interni. Basamento Ø mm 200 e coperchio (con foro) in acciaio pre zincato elettroliticamente, tubo trasparente in policarbonato. Verniciatura a polvere poliestere TGIC Free Qualicoat. Capacità 10 lt. Peso 2,7 kg.

PRB181 - contenitore trasparente per pile esauste, Ø tubo 120 mm x altezza 900 mm

CONTENITORE PER TONER E PER MEDICINALI SCADUTI

In acciaio smaltato colore giallo, lavabile e disinfettabile. Coperchio apribile con serratura a chiave. Bocchetta superiore di introduzione auto scaricante con maniglia di sollevamento. Scritte di identificazione del rifiuto. Capacità 100 lt. Dimensioni: Ø mm 400 x h mm 800. Peso kg 11.

4 PSAC100G - per toner, cartucce laser e ink-jet

5 PSAC100T - per medicinali scaduti



6



7



8



ARMADI MULTIUSO DI STOCCAGGIO

Armadi multiuso per stoccare in sicurezza sostanze potenzialmente pericolose ed inquinanti. Realizzati in solida struttura d'acciaio zincato a caldo, resistente agli agenti atmosferici. Per uso interno ed esterno. Caratteristiche principali: vasca di contenimento certificata TUV e StawaR, di grande capacità dotata di grigliato rimovibile. Porte a battente con chiusura a chiave e doppio comparto interno separato. Ripiani regolabili in acciaio zincato. Pareti laterali con prese d'aria per lo stoccaggio di sostanze infiammabili. Dimensioni esterne (l x p x h): mm 1395 x 905 x 1600. Volume di raccolta 216 lt.

6 PSA7922 - armadio di stoccaggio a 2 ripiani rimovibili

7 PSA7923 - armadio di stoccaggio a 3 ripiani rimovibili

8 PSA7924 - armadio di stoccaggio a 4 ripiani rimovibili



ARMADI STOCCAGGIO SOSTANZE PERICOLOSE E PESTICIDI



1



2



3



4

ARMADIO PER STOCCAGGIO

Per stoccaggio liquidi e solidi, ripiani di raccolta h mm 25, vasca sul fondo h mm 60. Costruiti in lamiera spessore 10/10 di colore giallo RAL1021 verniciato con polvere, cottura a forno 200° a norme ISO 1520-1519-2409-ECCA T5 e test nebbia salina. Angoli arrotondati; cerniera esterna con apertura di 180° e spina inox; piedino di regolazione MA mm 10 con base in plastica antiurto completo di controdamo; viti di fissaggio testa a brugola MA mm 5. Ripiani regolabili in altezza ogni 5 cm; maniglia ergonomica con serratura doppia chiave; paracolpi in gomma per chiusura morbida delle ante; feritoie di aerazione con sistema di foratura interna frangifiamma; treccia in rame per la messa a terra delle ante. **Forniti vuoti e smontati con imballo in cartone.** A richiesta in acciaio inox 10/10 AISI 430 2B.

- 1 **ARG1052** - 2 ante cieche, 2 ripiani regolabili portata lt 7 ciascuno, 1 vasca di raccolta da lt 27, capacità lt 403. Peso senza imballo kg 60, ingombro imballato: mm 1100 x 400 x 580 h. Dimensioni: mm 1075 x 500 x 1050 h
- 2 **ARG1852** - 2 ante cieche, 3 ripiani regolabili di contenimento con portata lt 7 ciascuno, 1 vasca di raccolta da lt 27, capacità lt 763. Peso senza imballo kg 88. Ingombro imballato: mm 1860 x 400 x 700 h. Dimensioni: mm 1075 x 500 x 1850 h
- 3 **ARG1050** - 1 anta cieca, 2 ripiani regolabili portata lt 4 ciascuno, 1 vasca di raccolta da lt 14, capacità lt 215. Peso senza imballo kg 40. Ingombro imballato: mm 1150 x 300 x 700 h. Dimensioni: mm 575 x 500 x 1050 h
- 4 **ARG0600** - 1 anta cieca con feritoie, 2 ripiani amovibili ma non regolabili, 1 vasca di raccolta da lt 3,6, capacità lt 60. Peso senza imballo kg 7. Ingombro imballato: mm 500 x 100 x 650 h. Dimensioni: mm 415 x 300 x 600 h

i **COMPONIBILI E MODULARI, GLI ARMADI SONO IDEALI PER STOCCARE IN SICUREZZA SOSTANZE PERICOLOSE LIQUIDE E SOLIDE.**



5



6



7



8

ARMADI PER FITOSANITARI E PESTICIDI

Armadi fornibili a richiesta in lamiera di acciaio al carbonio P02, spessore 10/10, pretrattato con fosfosgrassaggio in tunnel alte temperature. Verniciatura in epossipoliestere colore verde RAL 6001 e cottura in galleria termica a 180° C. Vasca di fondo.

- 5 **ARF200** - 1 anta cieca, 3 ripiani, mm 575 x 500 x 1850 h
- 6 **ARF100** - 2 ante - 3 ripiani, mm 1075 x 500 x 1850 h
- 7 **ARF300** - 2 ante - 2 ripiani, mm 1075 x 500 x 1100 h
- 8 **ARF400** - 1 anta - 2 ripiani, mm 575 x 500 x 1100 h



ARMADI PER STOCCAGGIO SOSTANZE INFIAMMABILI E PERICOLOSE



Resistenza al fuoco 90 minuti secondo la norma EN14470-1. Struttura in lamiera di acciaio elettrozincata con spessore da 10/10 a 20/10, pressopiegata a freddo e saldata. Verniciata con polveri epossidiche anticorrosione e passaggio in galleria termica a 200°C (spessore 90 micron). Particolare coibentazione (60 mm) con pannelli per alta temperatura in lana di roccia rivestita con fogli ceramici fissati con collanti ceramici. Finitura interna con pannelli in materiali anticorrosione. Chiusura delle porte automatica con temperatura ambiente superiore a 50°C. Guarnizione termoespandente da 30 mm su tutto il perimetro che sigilla l'armadio in caso di incendio [EN14470; DIN4102]. Dotato di morsetto di terra per la prevenzione delle cariche elettrostatiche. Serratura con chiave. Valvole certificate 90 minuti, chiudono i condotti ad una temperatura superiore a 70°C, una posta sul cielo per l'aspirazione, una sul fondo per garantire l'aspirazione dei vapori pesanti. Dotati di ripiani e vasca di fondo con griglia in acciaio verniciato amovibile.



RESISTENZA AL FUOCO CERTIFICATA. CHIUSURA AUTOMATICA CON TEMPERATURA > 50°C.



ARMADIO PER STOCCAGGIO PRODOTTI INFIAMMABILI

Resistenza al fuoco certificata 90 minuti. Ripiani a vassoio in acciaio verniciato fissati con pioli inox regolabili in altezza, portata 80 kg. Vasca di fondo in acciaio verniciato con griglia di appoggio. Colore grigio.

- 1 **AXT239** - armadio a 1 ante con 3 ripiani, peso kg 210. Dimensioni esterne mm 595 x 600 x 1950 (l x p x h). Capacità bottiglie da 1 lt: 80
- 2 **AXT232** - armadio a 2 ante con 3 ripiani, peso kg 350. Dimensioni esterne mm 1200 x 600 x 1950 (l x p x h). Capacità bottiglie da 1 lt: 160



ARMADIO PER STOCCAGGIO PRODOTTI INFIAMMABILI EASY

Resistenza al fuoco certificata 90 minuti. Ripiani in acciaio inox a cremagliera. Vasca di fondo in acciaio verniciato con griglia di appoggio. Disponibile a richiesta zoccolo per inserimento transpallet. Colore grigio.

- 3 **AX2060** - armadio a 1 ante con 3 ripiani, peso kg 210. Dimensioni esterne mm 590 x 600 x 1960 (l x p x h). Capacità bottiglie da 1 lt: 80
- 4 **AX2120** - armadio a 2 ante con 3 ripiani, peso kg 420. Dimensioni esterne mm 1190 x 600 x 1960 (l x p x h). Capacità bottiglie da 1 lt: 160



FORNIBILI A RICHIESTA ARMADI IN POLIETILENE MULTIUSO PER FUSTI E PICCOLI CONTENITORI. RICHIEDI UN PREVENTIVO!

ARMADIO DI SICUREZZA PER CHIMICI EN 61010-1 - CEI 66-5

Costruiti in lamiera di acciaio elettrozincata. Tre ripiani a vaschetta in acciaio con spessore 10/10. Regolazione a cremagliera dell'altezza del ripiano. Elettroaspiratore marchio CE. Termoprotezione interna; grado di protezione IP54 doppio isolamento. Fusibili di protezione. Portata aspiratore: max 275 mc/h. Alimentazione: 220/230 V - 50 Hz monofase. Assorbimento: 55W. Filtro a carbone attivo adatto per sostanze acide ad elevata superficie filtrante con prefiltra. Chiusura con serratura di sicurezza e chiave.

- 5 **AX106** - armadio a 2 ante con 3 ripiani, peso kg 125. Dimensioni esterne mm 1140 x 600 x 1900 (l x p x h). Capacità bottiglie da 1 lt: 120
- 6 **AX103** - armadio a 1 ante con 3 ripiani, peso kg 80. Dimensioni esterne mm 600 x 600 x 1900 (l x p x h). Capacità bottiglie da 1 lt: 60



1



2

ARMADI DI STOCCAGGIO

Armadi specifici per il contenimento di sostanze infiammabili. Riducono i rischi di incendio. Chiusura a 3 punti con blocchetti in acciaio inossidabile, piedini di posizionamento regolabili. Maniglia incassata e chiudibile anche con lucchetto (non fornito), ripiani di sicurezza regolabili e leggermente inclinati per favorire il deflusso di eventuali sversamenti verso la vasca di raccolta. Etichette rifrangenti per un'ottima visibilità anche al buio se illuminate da un fascio di luce. Messa a terra facilitata grazie al connettore integrato posto sulla parte esterna del pannello, verniciatura a polvere ibrida senza piombo interna ed esterna, durevole e resistente agli agenti chimici. Spigoli porte arrotondati, due strati che integrano un rompi fiamma posizionati: in basso in un fianco dell'armadio e in alto nel fianco opposto. Saldati e non avvitati. **Chiusura porte manuale.**

- 1 **AJ9450** - armadio di stoccaggio con 2 ante e 2 ripiani; capacità 170 lt; peso 132 kg; dimensioni: cm 165 x 109 x 46
- 2 **AJ9300** - armadio di stoccaggio con 2 ante e 1 ripiano; capacità 114 lt; peso 98 kg; dimensioni: cm 112 x 109 x 46
- 3 **AJ9315** - armadio di stoccaggio con 1 anta e 1 ripiano; capacità 57 lt; peso 64 kg; dimensioni: cm 112 x 59 x 46



3



4



5

4 FLACONE A COMPRESSIONE IN POLIETILENE

Distributori a compressione per liquidi infiammabili realizzati in polietilene ed acciaio inossidabile. La compressione del distributore produce un sottile flusso di liquido e ne impedisce l'eccessiva nebulizzazione. Valvola a sfera per un'erogazione sicura ed uniforme. Cannucia sagomabile per aree di difficile accesso.

CJ4009 - flacone distributore capacità 0,5 lt, dimensioni: Ø cm 7 x 19 h

CJ4011 - flacone distributore capacità 1 lt, dimensioni: Ø cm 9 x 23 h

5 CONTENITORI AUTOCHIUDENTI IN POLIETILENE

Per sostanze corrosive non infiammabili, in polietilene ad alta densità, traslucido, resistente ad acidi e caustici. Tappo a chiusura automatica e a molla, a garanzia di una tenuta ermetica. Becco senza rompifiamma per una rapida erogazione. Maniglia con levetta a scatto per versare con una sola mano. Maniglia in acciaio inossidabile.

CJ2161 - capacità 4 lt, becco Ø cm 3,7, mm 12 x 19 x 32 h

CJ2260 - capacità 9,5 lt, becco Ø cm 3,7, Ø mm 27 x 39 h

CJ2765 - capacità 19 lt, becco Ø cm 9,2, Ø mm 31 x 51 h



Caratteristiche principali dei contenitori di sicurezza JUSTRITE®

Realizzati in acciaio e verniciati con vernice a polvere resistente ai solventi (TIPO 1 e 2). Maniglia arrotondata (non taglia le mani) con leva di sicurezza per un versamento più veloce e controllato (TIPO 2). Maniglia controbilanciata: sfrutta il peso del contenitore per impedirne l'apertura durante il trasporto (TIPO 1). Bocchettone con leva di sollevamento per un facile riempimento (TIPO 2). Fondo di 13 mm più comodo nella fase di versamento e resistente in caso di superfici d'appoggio irregolari. Rompifiama in acciaio inossidabile, per un flusso più rapido del liquido ed una resistenza superiore alla corrosione. Ugello con valvola a prova di perdita che, grazie ad una pressione positiva, previene rotture o esposizioni (TIPO 2). Etichetta di pericolo in 3 lingue (TIPO 1 e 2). Nervature di rinforzo: rendono il contenitore più resistente agli urti (TIPO 1 e 2). Valvola a molla auto chiudente.



FORNIBILI
A RICHIESTA
ANCHE NEL
COLORE
ROSSO!

! PRODOTTI ESSENZIALI PER LA SICUREZZA INDUSTRIALE: RIDUCONO I RISCHI D'INCENDIO, PREVENGONO LA CONTAMINAZIONE AMBIENTALE, PROTEGGONO I LAVORATORI RIDUCENDO AL MINIMO IL RISCHIO DI INCIDENTI, MIGLIORANO LA GESTIONE DELL'UFFICIO E L'EFFICIENZA OPERATIVA.



CONTENITORI CON APERTURA SINGOLA (TIPO 1)

Contenitori di sicurezza con becco singolo per riempimento ed erogazione, in acciaio galvanizzato rivestito con verniciatura a polvere. Coperchio a chiusura automatica, doppia retina rompifiama, meccanismo di sfogo automatico per sovrappressioni.

- 1 CJ0110** - capacità 0,5 lt, dimensioni: Ø cm 12 x 17 h, **maniglia a scatto**
- CJ0111** - capacità 1 lt, dimensioni: Ø cm 21 x 21 h, **maniglia a scatto**
- 2 CJ0200** - capacità 4 lt, dimensioni: Ø cm 24 x 28 h, **maniglia oscillante**
- CJ0520** - capacità 9,5 lt, dimensioni: Ø cm 30 x 29 h, **maniglia oscillante**
- 3 CJ0502** - capacità 19 lt, dimensioni: Ø cm 30 x 43 h, **maniglia oscillante**
- 4 CJ1313E** - versione in acciaio inox, capacità 9,5 lt, dimensioni: Ø cm 30 x 25 h, peso kg 3,7, **maniglia oscillante**
- 5 CJ1315E** - versione in acciaio inox, capacità 19 lt, dimensioni: Ø cm 30 x 40 h, peso kg 4,6, **maniglia oscillante**



CONTENITORI CON MANIGLIA OSCILLANTE E TUBO DI VERSAMENTO FLESSIBILE (TIPO 2)

Contenitori con apertura e bocchello. Tubo metallico flessibile per il versamento di liquidi in piccole aperture. Realizzati in acciaio galvanizzato rivestito con verniciatura a polvere, dotati di maniglia oscillante. Coperchio chiusura automatica, scarico a terra predisposto sul tubo flessibile. Doppia retina rompifiama, meccanismo di sfogo automatico per sovrappressioni. Struttura ergonomica bilanciata che permette l'erogazione a gravità.

- 6 CJ0220** - capacità 7,5 lt, dimensioni Ø cm 24 x 34 h
- CJ0221** - capacità 9,5 lt, dimensioni Ø cm 30 x 30 h
- 7 CJ0230** - capacità 19 lt, dimensioni Ø cm 30 x 45 h

CONTENITORI CON RUBINETTO PER SPILLATURA

Contenitori ideali per professionisti di laboratorio che desiderano un'erogazione sicura di liquidi pericolosi in provette, piccoli matracci e becher. Realizzati in acciaio galvanizzato con verniciatura a polvere. Rubinetto di riempimento con tappo autochiudente, rubinetto di spillatura 51 mm dal fondo. Erogazione controllata del liquido.

- 8 CJ0808** - capacità 19 lt, dimensioni Ø cm 30 x 40
- CJ0805** - capacità 9,5 lt, dimensioni Ø cm 30 x 30
- 9 CJ1327E** - in acciaio inox, capacità 19 lt, dimensioni: Ø cm 30 x 40, peso kg 4,1



CONTENITORI DI SICUREZZA IN ACCIAIO INOX

Contenitori di sicurezza in **acciaio inossidabile**, ideali per l'utilizzo in laboratori scientifici, industriali o ospedalieri per lo stoccaggio di sostanze chimiche infiammabili particolarmente aggressive. Maniglia con levetta a scatto per il versamento con una sola mano, tappo con chiusura automatica che può essere bloccato per svuotare comodamente il contenitore, ampia apertura (angolo 80°). Rompifiamma integrato in acciaio, guarnizioni di sicurezza in gomma e sistema di sfogo automatico per pressione interna eccessiva.

- 1 **CJ1301E** - capacità 3,8 lt, dimensioni cm 20 x 23 h, peso 1,7 kg
- 2 **CJ1323E** - capacità 9,5 lt, dimensioni Ø cm 29 x 30 h, peso 3,7 kg
- 3 **CJ1325E** - capacità 19 lt, dimensioni Ø cm 29 x 45 h, peso 4,6 kg

4 BIDONI PER RIFIUTI OLEOSI

In acciaio galvanizzato verniciato a polvere. Previene rischi d'incendio quando si utilizzano panni impregnati di solvente o strofinacci. Coperchio con apertura max 60° a pedale. Base rialzata, maniglia per il trasporto.

- CJ9101** - capacità 20 lt, dimensioni Ø cm 30 x 40 h
- CJ9301** - capacità 34 lt, dimensioni Ø cm 35 x 46 h
- CJ9501** - capacità 52 lt, dimensioni Ø cm 41 x 51 h

5 CONTENITORE PER RECUPERO SOLVENTI

Per la raccolta sicura dei solventi utilizzati per il lavaggio dei pezzi. In acciaio galvanizzato, bocchello filettato 19 mm per l'eliminazione sicura dei liquidi residui. L'imbuto removibile in acciaio permette di versare i liquidi nel contenitore senza schizzi o versamenti.

- CJ0906** - capacità 18,92 lt, dimensioni Ø cm 30 x 43 h



IDEALI PER INUMIDIRE SEMPLICEMENTE E RAPIDAMENTE I PANNI PER LA PULITURA O TAMPONI.

TANICA A STANTUFFO IN ACCIAIO

Contenitori in acciaio galvanizzato spessore 0,5 mm, rivestimento con vernice a polvere. Ideali per inumidire semplicemente e rapidamente i panni per la pulitura o tamponi. Premendo sul gruppo pompa in ottone, il piatto superiore in acciaio si riempie di liquido, necessario per inumidire, senza straripare. Il liquido in eccesso viene nuovamente scaricato in modo sicuro nel serbatoio. Griglia del piattorrompi fiamma.

- 6 **CJ0018** - capacità 0,5 lt, dimensioni Ø cm 12 x 13
- 7 **CJ0118** - capacità 1 lt, dimensioni Ø cm 18 x 14 h
- 8 **CJ0218** - capacità 2 lt, dimensioni Ø cm 18 x 20 h
- 9 **CJ0318** - capacità 4 lt, dimensioni Ø cm 18 x 27 h



CONTENITORE LAVAPEZZI

Per lavaggio di pezzi di piccole dimensioni. Basta appoggiare il pezzo sul piatto a molla, quindi premere, scuotere e poi rilasciare. In acciaio galvanizzato rivestito con vernice a polvere. Piatto con funzione rompifiamma. Coperchio incernierato, bordo protetto.

- 10 **CJ0381** - piatto con funzione rompifiamma, dimensioni Ø 19 cm
- 11 **CJ0380** - contenitore capacità 4 lt, dimensioni Ø cm 24 x 11 h (piatto escluso)

12 CONTENITORE LAVAPEZZI

Ideale per il lavaggio di pezzi e sottogruppi. In acciaio galvanizzato spessore 0,5 mm rivestito con vernice a polvere. Coperchio ad azionamento manuale. Bloccaggio in posizione aperta. Meccanismo autochudente.

- CJ7606** - capacità 19 lt, dimensioni Ø cm 35 x 33 h x Ø 19 (Ø piatto)

13 CONTENITORI IN POLIETILENE

Per rifiuti o stracci sporchi d'olio, di solventi e sostanze infiammabili varie in polietilene, pedale per apertura automatica coperchio, maniglie, fondo svasato.

- CJ1393E** - capacità lt 23, dimensioni cm 34 x 41 h. Peso kg 4
- CJ1394E** - capacità lt 38, dimensioni cm 46 x 46 h. Peso kg 6,4
- CJ1395E** - capacità lt 53, dimensioni cm 46 x 53 h. Peso kg 7

14 TANICA A STANTUFFO IN POLIETILENE

Per inumidire panni con sostanze infiammabili o volatili. Premendo sul gruppo pompa, il piatto superiore si riempie di liquido, necessario per inumidire, senza straripare. Griglia del piatto rompi fiamma.

- CJ1371E** - capacità 1 lt, dimensioni cm 13 x 25 h. Peso 0,9 kg
- CJ1372E** - capacità 3,8 lt, dimensioni cm 20 x 33 h. Peso 1,9 kg



TANICHE E VASCHE PIEGHEVOLI PER CONTENIMENTO LIQUIDI PERICOLOSI



TANICHE IN METALLO OMOLOGATE UN

Taniche di colore verde militare, tappo di sicurezza a vite. Per il trasporto di sostanze pericolose (carburanti, petrolio, gasolio, cherosene, ecc) su strada, rotaia e mare.

- 1 **TANR** - raccordo di travaso compatibile con i modelli verniciati
- 2 **TAN5** - tanica in metallo colore verde militare, capacità 5 lt, dimensioni 230 x 120 x 330 mm (l x p x h), peso 1,9 kg
- 3 **TAN10** - tanica in metallo colore verde militare, capacità 10 lt, dimensioni 370 x 170 x 280 mm (l x p x h), peso 2,9 kg
- 4 **TAN20** - tanica in metallo colore verde militare, capacità 20 lt, dimensioni 350 x 160 x 470 mm (l x p x h), peso 4,2 kg

TANICHE IN PLASTICA OMOLOGATE UN

Taniche per combustibili e liquidi. In polietilene alta densità rinforzato con travasatore flessibile avvitabile. Tappo di chiusura ermetico con anello di sicurezza. Omologazione UN a norma direttiva CE.

- 5 **TANB10** - tanica in plastica omologata colore nero, capacità 10 lt, **confezione 6 taniche**
- TANB20** - tanica in plastica omologata colore nero, capacità 20 lt, **confezione 4 taniche**
- 6 **TANB5R** - tanica in plastica omologata colore rosso, capacità 5 lt, **confezione 12 taniche**



RICHIUDIBILE!

LE VASCHE DI CONTENIMENTO SONO FORNIBILI, A RICHIESTA IN ALTRI FORMATI, STANDARD O PERSONALIZZATI

VASCA DI CONTENIMENTO FLESSIBILE PIEGHEVOLE

Vasche di contenimento pieghevoli in tessuto rivestito con PVC, adatte allo stoccaggio e movimentazione di sostanze pericolose, resistenti a sostanze chimiche, a esposizione prolungata ai raggi UV e sono ideali per l'esterno. Struttura monoblocco con profondità parete 30 cm per garantire un contenimento sicuro e a prova di perdita. **Fornite piegate.**

- 7 **PSJ8368** - vasca di contenimento extra resistente, ideale per mezzi pesanti e ambienti ostili. Capacità 22.183 lt, dimensioni m 4,3 x 17,1 x 305 mm h (dimensioni piegata 1016 x 1016 x 610 mm)
- 8 **PSJ8512** - vasca di contenimento capacità lt 662, dimensioni cm 120 x 180 x 30 h (dimensioni piegata 61 x 61 x 13 h)
- PSJ8532** - vasca di contenimento capacità lt 11.318, dimensioni cm 610 x 610 x 30 h (dimensioni piegata 97 x 97 x 56 h)





Accessori



1 VALVOLA PER FUSTI

In ottone, per fusti custoditi in posizione orizzontale. Si apre automaticamente in caso di sovrappressione (pressione interna 0,35 bar); rilascio del vuoto manuale. Con rompifiama, adatta per idrocarburi.

CJ8300 - valvola per fusti

2 CHIAVE PER FUSTI

In lega di ottone antiscintilla e anticorrosiva. Apre i tappi dei fusti da 2" a 3/4".

CJ8805 - chiave, lunghezza 250 mm

3 CAVI PER MESSA A TERRA

Impediscono la formazione di scintille causate da cariche elettrostatiche generate dalla manipolazione dei liquidi infiammabili.

CJ8499 - cavo flessibile con doppi terminali a molla manuali, lunghezza 1 mt

4 IMBUTO PER TANICHE (TIPO 1)

In polipropilene, con bocchello a due sezioni regolabili. Doppio posizionamento per riempimento o versamento senza rimuovere l'imbuto.

CJ1202Y - imbuto dimensioni: Ø inferiore 13 mm, lunghezza 28,5 mm



RUBINETTI

5 CJ8540 - rubinetto di sicurezza regolabile da laboratorio in ottone con rompifiama integrato, struttura in ottone con guarnizioni in Teflon®

6 CJ8955 - rubinetto autochiodente per liquidi viscosi, fisso NPT, con rompifiama integrato, struttura in ottone con guarnizioni in Teflon® adatto a liquidi viscosi

7 CJ8910 - rubinetto autochiodente regolabile NPT con rompifiama integrato, struttura in ottone con guarnizioni in Teflon®

8 CJ8902 - rubinetto autochiodente fisso NPT con rompifiama integrato, struttura in ottone con guarnizioni in Teflon®

Posaceneri autoestinguenti

Prodotti essenziali per la sicurezza industriale: riducono i rischi d'incendio, prevengono la contaminazione ambientale, proteggono i lavoratori riducendo al minimo il rischio di incidenti, migliorano la gestione dell'ufficio e l'efficienza operativa.



ALTRI COLORI FORNIBILI A RICHIESTA



9 POSACENERE AUTOESTINGUENTE SMOKER'S CEASE FIRE®

Realizzato in polietilene ignifugo, resistente, non si arrugginisce, non si deforma e non si crepa. Design innovativo, secchio interno in acciaio galvanizzato permette di raccogliere in modo sicuro molteplici mozziconi di sigarette, riduce il rischio di incendio. Tacche di fissaggio per maggiore stabilità e sicurezza. Capacità 15 lt, dimensioni: cm 42 Ø x 98 h, peso kg 5.

CJP2680 - posaceneri autoestinguente colore beige (a richiesta fornibile in altri colori: nero, grigio, terracotta, verde)



10 POSACENERE AUTOESTINGUENTE ELITE SMOKER'S CEASE FIRE®

Realizzato in polietilene, estremamente resistente, con grata spegni sigaretta in acciaio inossidabili e secchio interno in acciaio rimovibile. Design moderno aggraziato. Capacità 15 lt, dimensioni: cm 31 Ø x 97 h.

CJP2685 - posaceneri autoestinguente colore nero



PRODOTTO ASSORBENTE PER ACIDO SOLFORICO

MINISTERO DELL'AMBIENTE E DELLA TUTELA DEL TERRITORIO E DEL MARE (DM AMBIENTE 24 GENNAIO 2011, N. 20)

Regolamento recante l'individuazione della misura delle sostanze assorbenti e neutralizzanti di cui devono dotarsi gli impianti destinati allo stoccaggio, ricarica, manutenzione, deposito e sostituzione degli accumulatori (GU n. 60 del 14/03/2011). Testo in vigore dal 29/03/2011.



1

COME UTILIZZARE SOLFONET?



Versare il prodotto circoscrivendo e coprendo il liquido fuoriuscito. Assicurarsi che la polvere assorba inglobando interamente l'acido solforico sversato.



Attendere 3/4 minuti la reazione esotermica (calore di neutralizzazione). Il prodotto virerà da rosso (miscela acida) a giallo (miscela neutralizzata).



Al termine della reazione, la polvere può essere raccolta e smaltita come rifiuto speciale non pericoloso.



CARTELLI SOLFONET (CODICI 35F250 E 27F250) A PAGINA 39.



POLVERE ASSORBENTE NEUTRALIZZANTE PER ACIDO SOLFORICO

Polvere assorbente neutralizzante per acido solforico dovuto all'improvvisa fuoriuscita di acido solforico dagli accumulatori (batterie). L'efficacia dell'assorbente è stata certificata da un Istituto specializzato in base alla Normativa Vigente: D.M. n° 20 del 24.01.2011 del Ministero dell'Ambiente. Assorbe inglobando totalmente l'acido solforico delle batterie sversato senza mai più rilasciarlo. La superficie rimane pulita, asciutta e calpestabile. Grazie al contenuto di una miscela di polveri speciali che danno una reazione esotermica (calore di neutralizzazione) che dura circa 3-4 minuti, Solfonet neutralizza l'acido solforico assorbito. La polvere utilizzata dovrà essere smaltita secondo le norme vigenti in materia, tenendo presente che quanto risulta dopo le due fasi di Solfonet può essere classificato come rifiuto speciale non pericoloso. 500 g di polvere Solfonet assorbono 1 lt di liquido. Solfonet ha una durata di 7 anni se conservato correttamente. Una volta aperto, se conservato in luogo fresco e asciutto, ha una durata di 24 mesi.

Modo d'uso: versare il prodotto circoscrivendo e coprendo il liquido fuoriuscito. Attendere 3-4 minuti che avvenga la reazione esotermica (calore di neutralizzazione) ed il viraggio di colore (**rosso = acido - giallo = neutralizzato**) quindi raccogliere e smaltire secondo le norme vigenti in materia.

1 **PAN5** - Solfonet in sacco da kg 5

PAN2 - Solfonet in sacco da kg 2,5

2 **PAN2K** - valigetta kit d'emergenza da kg 2,5 più accessori per sversamento acido solforico specifico per autotrasporti

3 **PAN5K** - armadietto kit d'emergenza da kg 5 più accessori per sversamento acido solforico specifico per stazioni di stoccaggio

4 **PAN3K** - armadietto kit d'emergenza da kg 17,5 più accessori per sversamento acido solforico specifico per stazioni di stoccaggio

5 **PAN4K** - armadietto kit d'emergenza da kg 35 più accessori per sversamento acido solforico specifico per stazioni di stoccaggio



2



3



4



5



CONTENUTO PAN2K

Valigetta in polipropilene colore arancio contenente:

- 1 polvere assorbente da kg 2,5
- 1 paio di guanti antiacido
- 1 scopino e paletta
- 4 sacchi smaltimento rifiuto
- 1 paio di occhiali
- 1 mascherina FFP2
- 1 manuale istruzioni

CONTENUTO PAN5K

Armadio pensile in metallo cm 40 x 20 x 58,5 h contenente:

- 1 polvere assorbente da kg 5
- 4 panni assorbenti per liquidi chimici 41 x 46 cm
- 1 paio di guanti antiacido
- 4 sacchi smaltimento rifiuto
- 1 paio di occhiali
- 1 mascherina FFP2
- 1 manuale istruzioni

CONTENUTO PAN3K

Armadio pensile in metallo cm 40 x 50 x 70 h contenente:

- 17,5 kg di Solfonet (1 sacco da 2,5 kg + 3 sacchi da 5 kg)
- 2 calze assorbenti per liquidi acidi caustici tossici
- 2 paia di guanti antiacido
- 3 sacchi smaltimento rifiuto
- 1 paio di occhiali
- 1 mascherina FFP2
- 1 manuale istruzioni

CONTENUTO PAN4K

Armadio pensile in metallo cm 40 x 50 x 70 h contenente:

- 35 kg di Solfonet (7 sacchi da 5 kg)
- 2 calze assorbenti per liquidi acidi caustici tossici
- 2 paia di guanti antiacido
- 4 sacchi smaltimento rifiuto
- 1 paio di occhiali
- 1 mascherina FFP2
- 1 manuale istruzioni



Prodotti per bloccare e deviare acqua e fanghi durante un allagamento.

Gamma innovativa di prodotti a forma di sacchi e salsicciotti contro gli allagamenti, composti da polimeri organici contenuti in un sacco leggero di polipropilene. Estremamente sottili, dopo la procedura di attivazione questi prodotti aumentano il loro volume fino a 24 volte. La loro tecnologia permette di assorbire, bloccare e deviare acqua e fanghi dopo un allagamento. Vantaggi: permette un intervento autonomo e rapido, blocca i trafileamenti d'acqua, è molto più efficace di un sacco di sabbia, è facile da conservare e da stoccare.



PRODOTTI CONTRO GLI ALLAGAMENTI

Le barriere e i salsicciotti si conservano in locali secchi fino a 4 anni nell'imballaggio d'origine, ad una temperatura di 5 - 30°C. Una volta attivati, i sacchi possono essere conservati ed utilizzati per circa 2 mesi, se non esposti al sole. Le barriere sono in tessuto non tessuto di polipropilene con nucleo in acrilato di sodio. La soluzione assorbente è un composto di polimeri organici che si gelificano istantaneamente a contatto con l'acqua, permettendo di spalare facilmente acque e fanghi riversatisi dentro i locali durante un'inondazione.

- 1 AUS04** - confezione da 4 sacchi anti inondazione, dimensioni 60 x 40 cm, peso 1,15 kg
- AUS10** - confezione da 10 sacchi anti inondazione, dimensioni 60 x 40 cm, peso 2,85 kg
- 2 AUS90** - confezione da 2 salsicciotti anti inondazione, dimensioni 90 x 18 cm, peso 490 gr
- AUS120** - confezione da 2 salsicciotti anti inondazione, dimensioni 120 x 18 cm, peso 550 gr
- 3 AUSSOL** - soluzione assorbente post inondazione 900 ml, peso 600 gr
- AUSSOLO1** - soluzione assorbente post inondazione 7000 ml, peso 4,8 kg

ISTRUZIONI D'USO

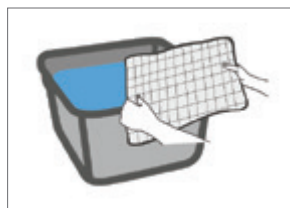

Immergere il prodotto nell'acqua fino a completa copertura, in breve il sacco comincerà ad assorbire l'acqua e gonfiarsi. Dopo circa 90 secondi le cuciture cominceranno a cedere.

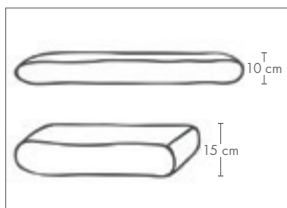

Dopo 90 secondi, rivoltare il sacco e tirare fino a far cedere tutte le cuciture. Dopo 3 minuti totali il sacco è pronto per l'utilizzo (peso 20 kg circa)



Mettere la copertura anti-UV davanti alla zona da proteggere. Posizionare i sacchi attivati sopra la copertura anti-UV in modo da essere stabili.



Ripiegare la copertura anti-UV sopra i sacchi coprendoli completamente per una totale protezione dai raggi del sole (i sacchi sono sensibili ai raggi-UV)

RIUTILIZZO

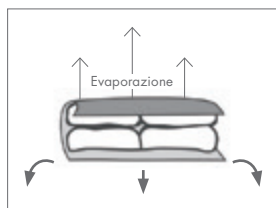

Una volta attivati i sacchi possono essere conservati al chiuso o all'aperto, avvolti nella copertura anti-UV. Col tempo il sacco perderà di volume per evaporazione e potrebbe rilasciare del gel.



Ad ogni riutilizzo, bisognerà seguire le istruzioni d'uso iniziali. È normale che con il passare del tempo le capacità di assorbimento dei sacchi diminuiscano.

SMALTIMENTO

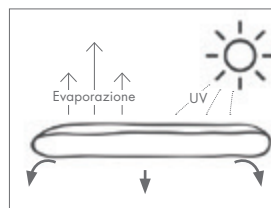

Lasciare il sacco all'azione del sole: il sacco si svuoterà rilasciando acqua sotto forma di gel, innocuo per l'uomo e l'ambiente. Una volta ingiallito, il sacco può essere smaltito nella differenziata.

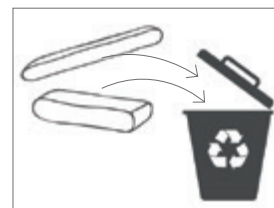

In alternativa si può: svuotare il sacco lasciando evaporare il contenuto e smaltire il sacco separatamente, oppure gettare il sacco con tutto il contenuto nella differenziata.

GUIDA ALLA SCELTA DEGLI ASSORBENTI



UTILIZZO

Gli assorbenti industriali vengono utilizzati per assorbire sversamenti o perdite accidentali di liquidi pericolosi che rappresentano un potenziale rischio per l'ambiente, la sicurezza e la salute dei lavoratori. Sversamenti, perdite e gocciolamenti durante la movimentazione e lo stoccaggio risultano essere una delle cause principali di inquinamento del terreno e della falda acquifera.

COMPOSIZIONE DEGLI ASSORBENTI

Gli assorbenti sono realizzati in fibra di polipropilene altamente assorbente. Catturano liquidi per metodo capillare, raggiungono elevati livelli di saturazione e ritenzione del liquido assorbito. Sono estremamente resistenti allo strappo e all'abrasione. Idonei per l'utilizzo in tutti gli ambiti produttivi.

VANTAGGI DERIVANTI DALL'UTILIZZO

Ogni perdita o sversamento di sostanze inquinanti comporta importanti costi durante la gestione e lo smaltimento. Gli assorbenti industriali sono più efficaci e rapidi rispetto a segatura, stracci, carta ecc. Sono versatili, disponibili in vari formati e idonei per svariate applicazioni. Permettono la riduzione dei costi di impiego e di smaltimento. Non contengono sostanze tossiche o nocive per le persone e per l'ambiente, sono inceneribili.

COME SCEGLIERE L'ASSORBENTE GIUSTO?

È molto importante determinare la tipologia dei liquidi utilizzati e stoccati facendo riferimento alle schede di sicurezza dei materiali. I prodotti sono disponibili in vari formati a seconda delle necessità ed applicazioni (vedi sotto).

SMALTIMENTO

Gli assorbenti acquisiscono le caratteristiche del liquido assorbito e lo smaltimento deve quindi avvenire in conformità alle disposizioni di legge. Il prodotto va sempre recuperato dopo l'utilizzo, raccolto in sacchi o contenitori appositi e il recupero, trasporto e smaltimento va affidato solo ad aziende certificate e qualificate. Durante l'attività di bonifica utilizzare sempre gli appositi dispositivi di protezione individuale.

FORMATI ED APPLICAZIONI



SALSICCIOTTI

Sono consigliati in casi di sversamento accidentale per circoscrivere la perdita. Impediscono la propagazione della perdita. Efficace metodo di prevenzione per evitare possibili scivolamenti.



BARRIERE

Svolgono la stessa funzione dei salsicciotti ma, considerata la maggior dimensione, sono ideali per assorbire uno sversamento di maggiore importanza. In versione oleoassorbente sono particolarmente indicate per assorbire oli in acqua.



PANNI

Assorbono piccole perdite da fusti, macchinari. Efficaci per la pulizia di piani di lavoro, utensili, macchinari.

COLORI E CATEGORIE

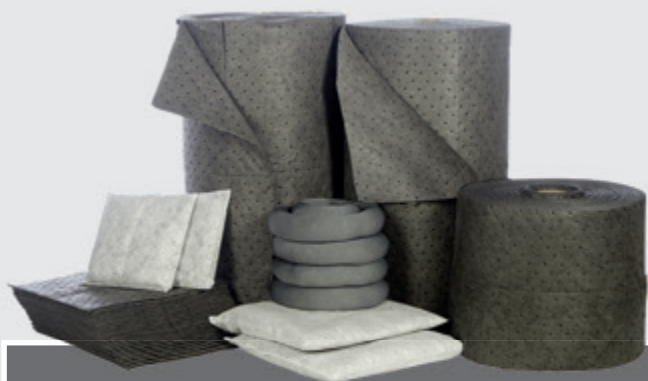

UNIVERSALI (COLORE GRIGIO)

- Solitamente di colore grigio, detti anche "maintenance".
- Tramite la tecnologia di soffiaggio a caldo del polipropilene si ottiene un "tessuto non tessuto" che cattura e trattiene liquidi oleosi e non intrappolandoli negli spazi interstiziali.
- Idonei per fluidi a base acquosa o d'olio e per diverse tipologie di liquidi non aggressivi e chimici: idrocarburi e derivati, oli motore, fluidi idraulici, refrigeranti, oli minerali, solventi ed acqua.
- Disponibili in panni, rotoli, cuscini, salsicciotti e kit di emergenza.



OLEOASSORBENTI (COLORE BIANCO)

- Specifici per l'assorbimento di oli, idrocarburi e derivati (solventi, essenze, gasolio, benzene, toluene, metanolo, ecc.)
- Idrofobi, non assorbono l'acqua. Ideali per utilizzo in esterno, sotto la pioggia, quando acqua ed olio devono essere separati.
- Galleggiano sull'acqua anche quando completamente saturi.
- Disponibili in panni, rotoli, cuscini, salsicciotti e kit di emergenza.
- Utilizzo: officine e industrie, bacini, corsi d'acqua, strade, piazzali, aree di manovra.



CHIMICI (COLORE GIALLO)

- È ben visibile e rappresenta un segnale di allerta per gli operatori.
- Assorbono un'ampia gamma di sostanze chimiche aggressive quali acidi, alcali, ossidanti, corrosivi, ecc.
- Adatti anche per fluidi a base d'acqua.
- Disponibili in panni, rotoli, cuscini, salsicciotti e kit di emergenza.
- Utilizzo: industria, laboratori, centri analisi, ospedali.

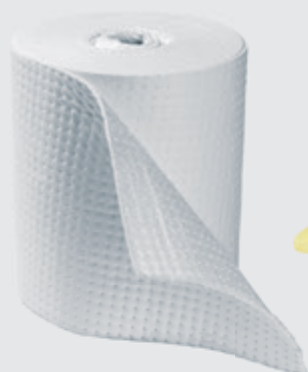

ROTOLI

Assorbono perdite e gocciolamenti da macchinari, impianti, nastri trasportatori. Idonei per rivestire banchi da lavoro.



CUSCINI

Assorbono grandi quantità di liquidi in piccoli spazi, si prestano ad essere inseriti tra tubazioni, raccordi, macchinari ecc. Utili durante lo smontaggio di parti delicate, oltre ad assorbire proteggono i componenti da eventuali danni.



KIT

Disponibili in varie capacità, raccolgono le varie tipologie di formati (rotoli, panni, salsicciotti, cuscini) e sono una risposta rapida per ogni emergenza, rendendo semplice l'intervento e la messa in sicurezza dell'area interessata.



ASSORBENTI MAINTENANCE UNIVERSALI COLORE GRIGIO

- Prodotti altamente assorbenti realizzati con fibra di polipropilene e ideati per sversamenti e perdite di liquidi industriali a base di olio e acqua.
- Idrofili e oleofili. Assorbono acqua, sostanze a base acquosa, oli, idrocarburi, refrigeranti, solventi.
- Non idonei a sostanze chimiche aggressive, caustiche e tossiche.
- Assicurano una maggiore sicurezza durante la manipolazione di liquidi infiammabili poiché antistatici.
- **I panni e i rotoli** sono ideali per operazioni di manutenzione ordinaria per la loro elevata capacità di assorbire liquidi.
- **I salsicciotti** sono consigliati in casi di sversamento accidentale per circoscrivere la perdita.
- **I cuscini** sono ideali per assorbire sversamenti concentrati in un'area e sotto tubazioni, macchinari, raccordi etc.

1



1 PANNI

ASU01P - panni perforati doppio spessore, dimensioni 41 x 46 cm, venduti in confezione da 100 pezzi, potere assorbente 120 lt per confezione

ASU02P - panni perforati singolo spessore, dimensioni 41 x 46 cm, venduti in confezione da 200 pezzi, potere assorbente 163 lt per confezione

2

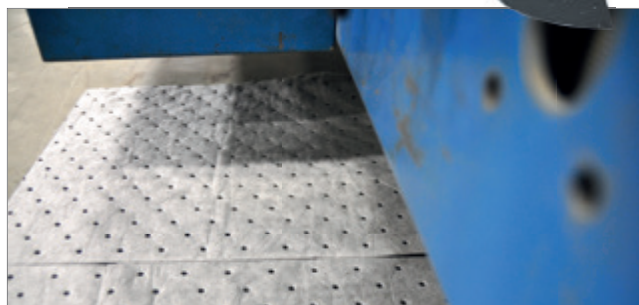
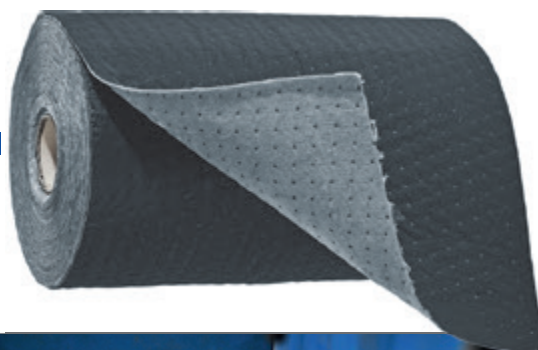

2 ROTOLI

ASU03R - rotoli perforati doppio spessore, dimensioni cm 81 x 46 metri, venduti in confezione da 1 pezzo, potere assorbente 240 lt per confezione

ASU04R - panni perforati doppio spessore, dimensioni cm 41 x 46 metri, venduti in confezione da 2 pezzi, potere assorbente 240 lt per confezione

3

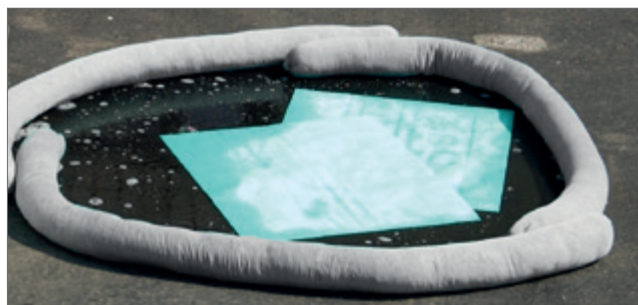

3 SALSICCIOTTI

ASU05S - salsicciotti assorbenti, dimensioni Ø 7,6 x 122 cm, venduti in confezione da 15 pezzi, potere assorbente 85 lt per confezione

ASU06S - salsicciotti assorbenti, dimensioni Ø 7,6 x 305 cm, venduti in confezione da 6 pezzi, potere assorbente 84 lt per confezione

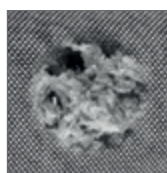

4

4 CUSCINI

ASU07C - cuscini assorbenti, dimensioni cm 25 x 25, venduti in confezione da 20 pezzi, potere assorbente 57 lt per confezione



5 COPRIFUSTI

ASU08F - panni coprifuoco, dimensioni Ø cm 56, venduti in confezione da 25 pezzi, potere assorbente 50 lt per confezione

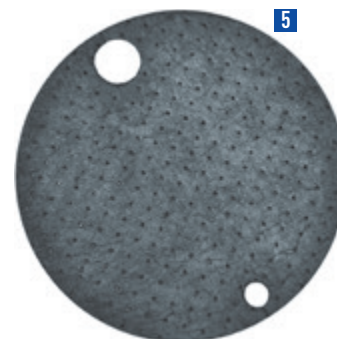

ASSORBENTI PER OLI COLORE BIANCO

- Prodotti altamente assorbenti realizzati con fibra di polipropilene e idonei per fuoriuscite e perdite di olio, idrocarburi, lubrificanti sia sul suolo che in acqua.
- Idrofobi. Non adatti a acqua, sostanze chimiche aggressive, caustiche e tossiche.
- Contribuiscono a mantenere il luogo di lavoro sempre pulito e sicuro.
- Assicurano una maggiore sicurezza durante la manipolazione di liquidi infiammabili poiché antistatici.
- Panni e rotoli sono ideali per operazioni di manutenzione ordinaria per la loro elevata capacità di assorbire liquidi. I salsicciotti sono consigliati in casi di sversamento accidentale per circoscrivere la perdita. I cuscini sono ideali per assorbire sversamenti concentrati in un'area e sotto tubazioni, macchinari, raccordi etc. Le barriere sono ideali per assorbire perdite di oli e idrocarburi in acqua. Disponibili in due diametri, lunghezza 3 m. Possono essere collegate insieme per coprire ampie aree. Continuano a galleggiare anche quando sono saturi. Il rivestimento interno impedisce lo sgocciolamento durante le operazioni di pulizia e rimozione.

1



1 PANNI

ASO01P - panni perforati doppio spessore, dimensioni 41 x 46 cm, venduti in confezione da 100 pezzi, potere assorbente 120 lt per confezione

ASO02P - panni perforati singolo spessore, dimensioni 41 x 46 cm, venduti in confezione da 200 pezzi, potere assorbente 163 lt per confezione

2



2 ROTOLI

ASO03R - rotoli perforati doppio spessore, dimensioni cm 81 x 46 metri, venduti in confezione da 1 pezzo, potere assorbente 240 lt per confezione

ASO04R - panni perforati doppio spessore, dimensioni cm 41 x 46 metri, venduti in confezione da 2 pezzi, potere assorbente 240 lt per confezione

3



3 BARRIERE

ASO09B - barriere assorbenti, dimensioni Ø cm 20 x 3 metri, venduti in confezione da 4 pezzi, potere assorbente 269 lt per confezione

ASO10B - barriere assorbenti, dimensioni Ø cm 13 x 3 metri, venduti in confezione da 4 pezzi, potere assorbente 135 lt per confezione



4

4 SALSICCIOTTI

ASO05S - salsicciotti assorbenti, dimensioni Ø 7,6 x 122 cm, venduti in confezione da 15 pezzi, potere assorbente 85 lt per confezione

ASO06S - salsicciotti assorbenti, dimensioni Ø 7,6 x 305 cm, venduti in confezione da 6 pezzi, potere assorbente 84 lt per confezione

5



5 CUSCINI

ASO07C - cuscini assorbenti, dimensioni cm 25 x 25, venduti in confezione da 20 pezzi, potere assorbente 57 lt per confezione

6

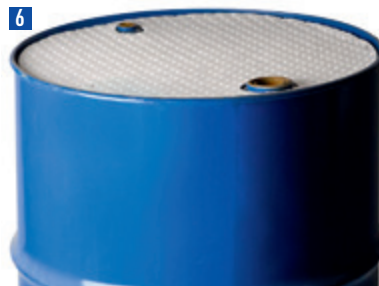

6 COPRIFUSTI

ASO08F - panni coprifusto, dimensioni Ø cm 56, venduti in confezione da 25 pezzi, potere assorbente 50 lt per confezione



ASSORBENTI PER CHIMICI **COLORE GIALLO**

- Prodotti altamente assorbenti realizzati con fibra di polipropilene e ideati per assorbire sostanze chimiche, acidi, basi, agenti caustici.
- Ideali per industria chimica, laboratori, ospedali, aree di stoccaggio prodotti chimici. Di colore giallo per allertare del possibile rischio.
- Assicurano una maggiore sicurezza durante la manipolazione di liquidi infiammabili poiché antistatici.
- Trattati in superficie per evitare fuoriuscite di vapori.
- Panni e rotoli sono ideali per operazioni di manutenzione ordinaria per la loro elevata capacità di assorbire liquidi.
- I salsicciotti sono consigliati in casi di sversamento accidentale per circoscrivere la perdita.
- I cuscini sono ideali per assorbire sversamenti concentrati in un'area e sotto tubazioni, macchinari, raccordi etc.

1



1 PANNI

ASC01P - panni perforati doppio spessore, dimensioni 41 x 46 cm, venduti in confezione da 100 pezzi, potere assorbente 94 lt per confezione

ASC02P - panni perforati singolo spessore, dimensioni 41 x 46 cm, venduti in confezione da 200 pezzi, potere assorbente 121 lt per confezione

2

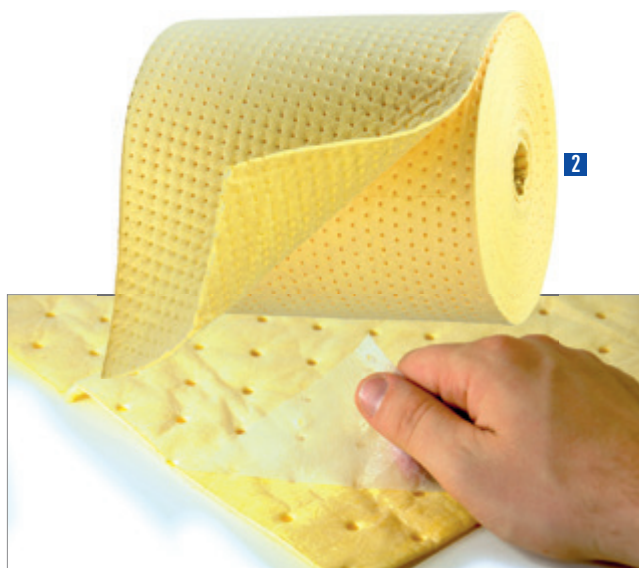

2 ROTOLI

ASC03R - rotoli perforati doppio spessore, dimensioni cm 81 x 46 metri, venduti in confezione da 1 pezzo, potere assorbente 187 lt per confezione

ASC04R - panni perforati doppio spessore, dimensioni cm 41 x 46 metri, venduti in confezione da 2 pezzi, potere assorbente 187 lt per confezione

3



3 SALSICCIOTTI

ASC05S - salsicciotti assorbenti, dimensioni Ø 7,6 x 122 cm, venduti in confezione da 15 pezzi, potere assorbente 85 lt per confezione

ASC06S - salsicciotti assorbenti, dimensioni Ø 7,6 x 305 cm, venduti in confezione da 6 pezzi, potere assorbente 84 lt per confezione

4



4 CUSCINI

ASC07C - cuscini assorbenti, dimensioni cm 25 x 25, venduti in confezione da 20 pezzi, potere assorbente 57 lt per confezione



IN CASO DI SOSTANZE CHIMICHE, VERIFICATE SEMPRE LA COMPATIBILITÀ PRIMA DI EFFETTUARE L'ATTIVITÀ DI BONIFICA.



ASSORBENTI IN KIT

Kit ADR in sacca di nylon con manici e contenuti per la sicurezza durante il trasporto di materiali pericolosi.



1

1 SAC01 - kit sacca ADR serie Universal, assorbenza minima 29 lt. Contiene:

- 15 panni 41 x 46 cm
- 2 salsicciotti Ø 7,6 x 122 cm
- 1 paio di guanti in nitrile
- 1 paio di occhiali protettivi
- 3 sacchi per smaltimento rifiuti



2

2 SAC02 - kit sacca ADR serie Oil, assorbenza minima 24 lt. Contiene:

- 15 panni 41 x 46 cm
- 2 salsicciotti Ø 7,6 x 122 cm
- 1 paio di guanti in nitrile
- 1 paio di occhiali protettivi
- 3 sacchi per smaltimento rifiuti



3

3 SAC03 - kit sacca ADR serie Chemical, assorbenza minima 25 lt. Contiene:

- 15 panni 41 x 46 cm
- 2 salsicciotti Ø 7,6 x 122 cm
- 1 paio di guanti in nitrile
- 1 paio di occhiali protettivi
- 3 sacchi per smaltimento rifiuti



KIT PER ASSORBIMENTO OLI

In bidone cilindrico di polietilene omologato ONU, tenuta stagna, chiusura con fascia metallica zincata.



5



4

4 BIDONE 39 LITRI

ASB030 - bidone ADR serie Oil, assorbenza minima 39 lt. Contiene:

- 20 panni 41 x 46 cm
- 4 salsicciotti Ø 7,6 x 122 cm
- 1 paio di guanti in nitrile
- 1 paio di occhiali protettivi
- 3 sacchi per smaltimento rifiuti



5 BIDONE 59 LITRI

ASB060 - bidone ADR serie Oil, assorbenza minima 59 lt. Contiene:

- 30 panni 41 x 46 cm
- 4 salsicciotti Ø 7,6 x 122 cm
- 4 cuscini 25 x 25 cm
- 1 paio di guanti in nitrile
- 1 paio di occhiali protettivi
- 3 sacchi per smaltimento rifiuti



6

7

6 BIDONE 75 LITRI

ASB120 - bidone ADR serie Oil, assorbenza minima 75 lt. Contiene:

- 50 panni 41 x 46 cm
- 4 salsicciotti Ø 7,6 x 122 cm
- 4 cuscini 25 x 25 cm
- 2 paia di guanti in nitrile
- 2 paia di occhiali protettivi
- 3 sacchi per smaltimento rifiuti

7 BIDONE 105 LITRI

ASB220 - bidone ADR serie Oil, assorbenza minima 105 lt. Contiene:

- 100 panni 41 x 46 cm
- 4 salsicciotti Ø 7,6 x 122 cm
- 2 paia di guanti in nitrile
- 2 paia di occhiali protettivi
- 3 sacchi per smaltimento rifiuti



1 KIT SERIE UNIVERSALE IN BIDONE CARRELLATO COLORE GRIGIO

BIDONE 120 LITRI

ASUK120 - bidone carrellato serie Universal da 120 lt, assorbenza minima 145 lt. Contiene:

- 50 panni 41 x 46 cm
- 12 salsiccioiti Ø 7,6 x 122 cm
- 6 cuscini 25 x 25 cm
- 2 paia di guanti in nitrile
- 2 paia di occhiali protettivi
- 3 sacchi per smaltimento rifiuti

BIDONE 360 LITRI

ASUK360 - bidone carrellato serie Universal da 360 lt, assorbenza minima 376 lt. Contiene:

- 200 panni 41 x 46 cm
- 18 salsiccioiti Ø 7,6 x 122 cm
- 12 cuscini 25 x 25 cm
- 2 paia di guanti in nitrile
- 2 paia di occhiali protettivi
- 9 sacchi per smaltimento rifiuti

BIDONE 240 LITRI

ASUK240 - bidone carrellato serie Universal da 240 lt, assorbenza minima 271 lt. Contiene:

- 150 panni 41 x 46 cm
- 12 salsiccioiti Ø 7,6 x 122 cm
- 8 cuscini 25 x 25 cm
- 2 paia di guanti in nitrile
- 2 paia di occhiali protettivi
- 6 sacchi per smaltimento rifiuti



SERIE UNIVERSALE,
ASSORBENZA
120 - 240 - 360 LITRI



2 KIT SERIE OIL IN BIDONE CARRELLATO COLORE BIANCO

BIDONE 120 LITRI

ASOK120 - bidone carrellato serie Oil da 120 lt, assorbenza minima 145 lt. Contiene:

- 50 panni 41 x 46 cm
- 12 salsiccioiti Ø 7,6 x 122 cm
- 6 cuscini 25 x 25 cm
- 2 paia di guanti in nitrile
- 2 paia di occhiali protettivi
- 3 sacchi per smaltimento rifiuti

BIDONE 360 LITRI

ASOK360 - bidone carrellato serie Oil da 360 lt, assorbenza minima 376 lt. Contiene:

- 200 panni 41 x 46 cm
- 18 salsiccioiti Ø 7,6 x 122 cm
- 12 cuscini 25 x 25 cm
- 2 paia di guanti in nitrile
- 2 paia di occhiali protettivi
- 9 sacchi per smaltimento rifiuti

BIDONE 240 LITRI

ASOK240 - bidone carrellato serie Oil da 240 lt, assorbenza minima 271 lt. Contiene:

- 150 panni 41 x 46 cm
- 12 salsiccioiti Ø 7,6 x 122 cm
- 8 cuscini 25 x 25 cm
- 2 paia di guanti in nitrile
- 2 paia di occhiali protettivi
- 6 sacchi per smaltimento rifiuti



SERIE OIL,
ASSORBENZA
120 - 240 - 360 LITRI



3 KIT SERIE CHIMICI IN BIDONE CARRELLATO COLORE GIALLO

BIDONE 120 LITRI

ASCK120 - bidone carrellato serie Chemical da 120 lt, assorbenza minima 132 lt. Contiene:

- 50 panni 41 x 46 cm
- 12 salsiccioiti Ø 7,6 x 122 cm
- 6 cuscini 25 x 25 cm
- 2 paia di guanti in nitrile
- 2 paia di occhiali protettivi
- 3 sacchi per smaltimento rifiuti

BIDONE 360 LITRI

ASCK360 - bidone carrellato serie Chemical da 360 lt, assorbenza minima 324 lt. Contiene:

- 200 panni 41 x 46 cm
- 18 salsiccioiti Ø 7,6 x 122 cm
- 12 cuscini 25 x 25 cm
- 2 paia di guanti in nitrile
- 2 paia di occhiali protettivi
- 9 sacchi per smaltimento rifiuti

BIDONE 240 LITRI

ASCK240 - bidone carrellato serie Chemical da 240 lt, assorbenza minima 232 lt. Contiene:

- 150 panni 41 x 46 cm
- 12 salsiccioiti Ø 7,6 x 122 cm
- 8 cuscini 25 x 25 cm
- 2 paia di guanti in nitrile
- 2 paia di occhiali protettivi
- 6 sacchi per smaltimento rifiuti



SERIE CHIMICI,
ASSORBENZA
120 - 240 - 360 LITRI



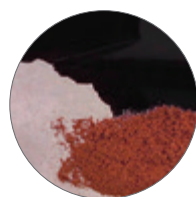

GRANULARE NATURALE

Granulato universale 100% naturale ottenuto dai filamenti della noce di cocco, non produce agenti cancerogeni né polvere. Con una capacità assorbente più che quadrupla rispetto all'argilla granulare, questo prodotto è perfetto sia per interni che per esterni. Prodotto ecologico, leggero e facile da smaltire.

- 1 **UASB03** - granulato assorbente, barattolo da 3 lt
- 2 **UASB15** - granulato assorbente, sacco da 15 lt
- 3 **UASB50** - granulato assorbente, sacco da 50 lt

4 SACCHI GRANULATO

Sacco granulato minerale grosso tipo IIIIR UNIVERSALE. Assorbe in pochi secondi. Ogni sacco da 38 lt è sufficiente per circa 16 lt d'olio combustibile.

UASA020 - granulato grosso assorbente, sacco da 20 kg

5 SACCHI GRANULATO

Sacco granulato fine UNIVERSALE tipo IIIIR UNIVERSALE. Assorbe in pochi secondi. Ogni sacco da 40 lt è sufficiente per circa 26 lt d'olio combustibile.

UASA022 - granulato fine assorbente, sacco da 20 kg



6 ASSORBITORE INDUSTRIALE VEGETALE IGNIFUGO

Assorbe ogni tipo di liquido, olio, acqua, solventi, inchiostri, acidi deboli e basi, prodotti chimici, sostanze grasse, così come miscugli ed altra sporcizia sparsa incidentalmente sui terreni. Capacità di assorbimento dal 400% al 650% del proprio peso. Ideale nelle officine meccaniche in generale e di precisione, l'industria automobilistica, aeronautica, autorimesse, le stazioni di servizio, le aree di transito, strade ed autostrade, industria petrolifera e chimica, ecc. Si smaltisce attraverso incenerimento o conferimento alla discarica seguendo la regolamentazione in vigore e in base al prodotto assorbito. Composto da lignina e cellulosa. Non contiene argilla né silicene.

UCS100 - assorbitore industriale vegetale, sacco da kg 6,5 (volume 45 l)



DURANTE L'ATTIVITÀ DI BONIFICA UTILIZZARE SEMPRE GLI APPOSITI DPI (VEDI SEZIONE A PAGINA 335).



7 BARRIERE CILINDRICHE

Barriere assorbenti a fibra fine per **olio o benzine**; idrorepellenti, adatte per uso in esterni in condizioni disagiate come l'utilizzo in condizioni climatiche avverse.

UABS180 - confezione 12 barriere cilindriche Ø 7,5 x 180 cm. Capacità di assorbimento 138 lt/confezione

UABS300 - confezione 4 barriere cilindriche Ø 7,5 x 300 cm. Capacità di assorbimento 58 lt/confezione



BARRIERE DI TENUTA

Realizzata con una miscela speciale di materie plastiche, aderisce al suolo e protegge l'ambiente dai liquidi fuoriusciti accidentalmente. Da usare su terreni lisci, resistente a **idrocarburi** e alla maggior parte delle **sostanze chimiche**. Lavabile e riutilizzabile.

8 **UABF200** - barriera lineare, lunghezza mm 2000 x 45 x 50 h

9 **UABF040** - barriera ad anello, Ø interno 400 mm



PRODOTTI ASSORBENTI PER SVERSAMENTI ACCIDENTALI



1



2



i **LIMITI D'USO:** NON UTILIZZARE I PRODOTTI PER ASSORBIRE LE SEGUENTI SOSTANZE CONCENTRATE: OLEUM, ACIDO CLOROSULFONICO, BROMO LIQUIDO, ACIDO NITRICO (FUMIGANTE), ACIDO CROMICO, ACIDO SOLFORICO, PEROSSIDO DI IDROGENO. 3M RACCOMANDA DI CONDURRE UNA PROVA DI COMPATIBILITÀ PRIMA DI UTILIZZARE GLI ASSORBITORI CON I LIQUIDI IN QUESTIONE. LA PROVA È ESSENZIALE IN CASO DI UTILIZZO A TEMPERATURE SUPERIORI A 60°C.

LINEA UNIVERSALE

È un prodotto di pronto intervento contro sversamenti accidentali di sostanze pericolose. La struttura in microfibre di polipropilene (chimicamente inerte) è in grado di assorbire rapidamente un'ampia gamma di liquidi quali: Acidi diluiti, Olii/idrocarburi, Chetoni, Alcoli, Alkali, Aromatici, Solventi Clorurati, Glicoli, Acqua. L'elevato potere assorbente, fino a 18 volte il proprio peso, è ottenuto per mezzo di milioni di microfibre di polipropilene che assorbono i liquidi per capillarità.

- 1 USD201 - dispenser** contenente un rotolo da cm 12 x m 15,2. Può essere usato come mini-barriera, cuscino, foglio o rotolo. Pretagliato ogni cm 40. Peso kg 8,2. Minimo ordinabile 3 dispenser/multipli. Potere assorbente: lt 119
- 2 US200 - barriere cilindriche** per circoscrivere la fuoriuscita di sostanze pericolose, Ø cm 7,5 x m 1,2. Minimo ordinabile 12 barriere/multipli, peso 5,5 kg, potere assorbente: lt 42



3



4

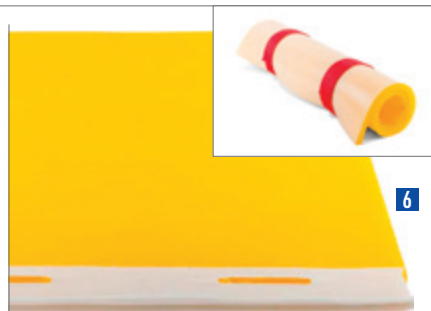

6



5



! CON I PRODOTTI ASSORBENTI, LE SOSTANZE VENGONO SOLAMENTE ASSORBITE, NON NEUTRALIZZATE; PERCIÒ È NECESSARIO USARE GLI APPROPRIATI MEZZI PROTETTIVI PERSONALI ED ESEGUIRE LO SMALTIMENTO IN CONFORMITÀ ALLE LEGGI.

3 KIT PRONTO INTERVENTO PER LABORATORIO



Kit di emergenza per sversamenti pericolosi. Ogni kit contiene un set di assorbitori chimici che permettono un veloce ed efficace contenimento delle sostanze contaminanti mantenendo le zone interessate da sversamenti di sostanze chimiche pericolose, pulite e sicure. Minimo ordinabile 5 pezzi/multipli. Potere assorbente: lt 5.

USK05 - kit di assorbitori liquidi per laboratorio composto da: 10 fogli US110, 1 cuscino US300, 1 sacchetto per smaltimento rifiuti. Dimensioni: cm 28 x 40 x 7

ASSORBITORI LINEA MANUTENZIONE



Ideali per assorbire oli e altri liquidi industriali in modo sicuro ed efficiente permettendo di mantenere pulito l'ambiente lavorativo. Sono facili da utilizzare e recuperare, riducono il rischio di contaminazione dei prodotti finiti e riducono il rischio di danneggiamento di macchinari costosi.

4 USM102 - barriere cilindriche Ø cm 7,5 x cm 240. Minimo ordinabile 6 barriere/multipli, peso 5,5 kg, potere assorbente lt 45

5 USM201 - dispenser contenente un rotolo da cm 12 x m 15,2. Può essere usato come mini-barriera, cuscino, foglio o rotolo

6 TAPPETI DI TENUTA

In caso di incidente permettono di intervenire in modo rapido ed efficiente impedendo che si verifichino penetrazioni di sostanze nocive nel terreno e nelle canalizzazioni andando a coprire tombini ed aperture nel terreno.

UAT4040 - tappeto mm 400 x 400

UAT8080 - tappeto mm 800 x 800

UAT1200 - tappeto mm 1200 x 1200

UAT0850 - tappeto Ø mm 850

i

A RICHIESTA, TAPPETI FORNIBILI IN ALTRE DIMENSIONI. RICHIEDI UN PREVENTIVO!



ARTICOLI PER COLLETTIVITÀ, RACCOLTA DEI RIFIUTI E IGIENE

ARMADI SPOGLIATOIO	518-519
PANCHINE PER SPOGLIATOI.....	519
PORTABICICLETTE E PANCHINE	520-521
CARTA ASCIUGAMANI E PRODOTTI PER L'IGIENE	522-523
POSACENERI E GETTACARTA AUTOESTINGUENTI	524
GETTACARTA MODULARI E PER LA RACCOLTA DIFFERENZIATA	525
POSACENERI E GETTACARTA PER INTERNI ED ESTERNI.....	526-527
STAZIONI PER LA RACCOLTA DIFFERENZIATA.....	528-529
GETTACARTA MURALE E MODULARI DA PAVIMENTO	529-530
PATTUMIERE A PEDALE, CON CARRELLO REGGISACCO E HACCP.....	531-532
CESTINI MILANO E KIT PER DEIEZIONI CANINE	533
BIDONI, CARRELLO E TRESPOLO PORTARIFIUTI	534
SACCHI PORTARIFIUTI.....	534
CASSONETTI PORTARIFIUTI A 2 RUOTE.....	535-536
CASSONETTI PORTARIFIUTI A 4 RUOTE	536



Armadi spogliatoio

Armadi spogliatoio costruiti in lamiera d'acciaio spessore 6/10 con bordi ripiegati, ante con apertura a 180° montate su speciali cerniere antieffrazione, provviste di asole e forature per un'ottimale circolazione dell'aria e predisposte per cartellino portanome. Chiusura con maniglia metallica lucchettabile con dispositivo antiscasso. Piedini in lamiera stampata e saldata con puntale in materiale plastico predisposto per l'applicazione di piedino regolabile o zoccolo di finitura. Verniciatura colore grigio RAL 7035 con smalti in polveri epossipoliesteri. Tutti gli armadi vengono forniti montati.



ARMADI TRADIZIONALI

Corredati internamente con pianetto superiore portaoggetti, astina appendiabiti con ganci in metallo zincato, portaombrelli con raccogliacqua.

- 1 **ARB1121** - armadio ad 1 ante, dimensioni cm 35 x 50 x 180 h
- 2 **ARB1122** - armadio a 2 ante, dimensioni cm 70 x 50 x 180 h
- 3 **ARB1123** - armadio a 3 ante, dimensioni cm 105 x 50 x 180 h

ARMADI CON TRAMEZZE PER LA DIVISIONE DEGLI ABITI

Corredati internamente con pianetto superiore portaoggetti, astina appendiabiti con ganci in metallo zincato, tramezza, portaasciugamani/portaombrelli con bicchiere raccogliacqua.

- 4 **ARB7171** - armadio ad 1 ante, cm 42 x 50 x 180 h
- 5 **ARB7172** - armadio a 2 ante, cm 81 x 50 x 180 h
- 6 **ARB7173** - armadio a 3 ante, cm 120 x 50 x 180 h

ARMADI TRADIZIONALI AD ANTE SOVRAPPOSTE

Corredati internamente con astina appendiabiti.

- 7 **ARB1132** - armadio a 2 ante sovrapposte, dimensioni cm 32 x 50 x 180 h
- 8 **ARB1134** - armadio a 4 ante sovrapposte, dimensioni cm 61,5 x 50 x 180 h
- 9 **ARB1136** - armadio a 6 ante sovrapposte, dimensioni cm 91 x 50 x 180 h



1

1 TETTUCCI INCLINATI PER ARMADI SPOGLIATOIO

Si applicano agli armadi spogliatoio mediante kit di tasselli in plastica forniti a corredo.

ARB3550 - tetto per ARB1121, cm 35 x 50 x 30 h

ARB7050 - tetto per ARB1122, cm 61 x 50 x 30 h

ARB1550 - tetto per ARB1123, cm 91 x 50 x 30 h

ARB4050 - tetto per ARB7171, cm 42 x 50 x 30 h

ARB8050 - tetto per ARB7172, cm 81 x 50 x 30 h

ARB2050 - tetto per ARB7173, cm 120 x 50 x 30 h

2



3



4



ARMADI A CASELLE

2 ARB1704 - armadio a 4 sportelli, dimensioni cm 42 x 50 x 180 h

3 ARB1708 - armadio a 8 sportelli, dimensioni cm 81 x 50 x 180 h

4 ARB1712 - armadio a 12 sportelli, dimensioni cm 120 x 50 x 180 h



5

5 PANCHINE PER SPOGLIATOIO CON SEDUTA IN LEGNO

Panchine smontabili con struttura in tubolare d'acciaio a sezione quadra da mm 30 x 30 x 1,5, fianchi portanti provvisti di puntali in gomma, con piedi regolabili e traverso di sostegno per barra porta scarpe (da ordinare separatamente). Seduta realizzata a doghe in legno da cm 100 x 20 smussato, levigato e verniciato al naturale. Spalliera appendiabiti realizzata in tubolare d'acciaio a sezione quadra da mm 30 x 30 x 1,5, agganciabile alla panca a mezzo di bulloni 8MA zincati con pomoli appendiabiti finitura color argento. Colori: grigio RAL 7035 e legno verniciato al naturale. Fornite smontate.

PAB110 - panchina cm 100 x 35 x 45 h

PAB315 - panchina cm 150 x 35 x 45 h

PAB520 - panchina 200 x 35 x 45 h

6



6 PORTASCARPE PER PANCHINE

PAB2010 - portascarpe per panca da cm 100

PAB2215 - portascarpe per panca da cm 150

PAB2420 - portascarpe per panca da cm 200

7



7 PANCHINE CON APPENDIABITI E MENSOLA

PAB710 - panchina appendiabiti cm 100 x 40 x 185 h

PAB915 - panchina appendiabiti cm 150 x 40 x 185 h

PAB112 - panchina appendiabiti cm 200 x 40 x 185 h



PORTABICICLETTE

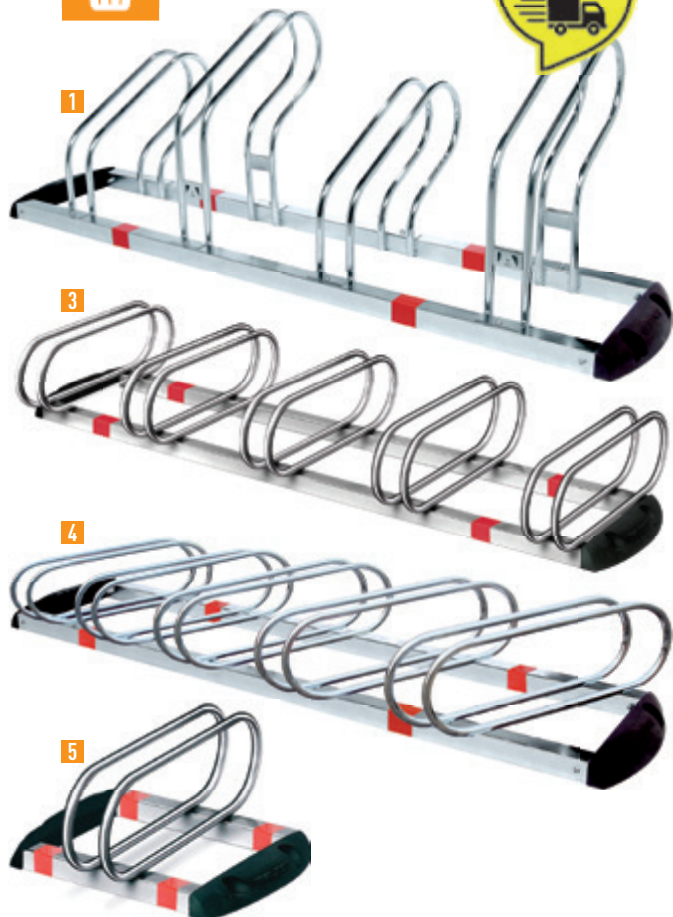

MONTAGGIO MODULARE TRAMITE KIT ASR400K

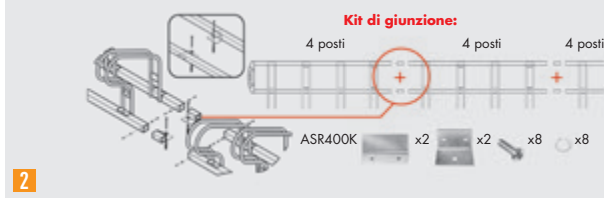

PORTABICICLETTE



Portabiciclette dotato di originali piedi di fissaggio dalle forme arrotondate e gradevoli, realizzati con materiali HI-TECH (Nylon caricato con fibra di vetro "Fiber Glass", materiale molto resistente), trattamento anticorrosione elettrozincatura. Imballo in cartone individuale.

- ASR400** - portabiciclette con lato singolo a 4 posti, mm 1529 x 465,5 x 464 h, altezza sfalsata degli anelli su due livelli. Fornito smontato, con kit di montaggio incluso. A richiesta fornito montato (in questo caso sistema di fissaggio a terra escluso). Peso kg 12,7
- ASR400K** - kit composto da 4 piastre (2 + 2), 8 viti, 8 rondelle per creare modularità ai portabiciclette modelli ASR400 e ASR101
- ASR500D** - portabiciclette a 5 posti dritti, mm 1626 x 510 x 226 h, posizionamento biciclette da entrambi i lati. Kit fissaggio a terra incluso. Peso kg 12
- ASR500** - portabiciclette a 5 posti inclinati (60°), mm 1786 x 443,8 x 226 h, posizionamento biciclette da entrambi i lati. Kit fissaggio a terra incluso. Peso kg 12
- ASR101** - portabiciclette a 1 posto modulare, mm 510 x 480 x 226 h. Kit di fissaggio a terra incluso. Peso kg 3,8

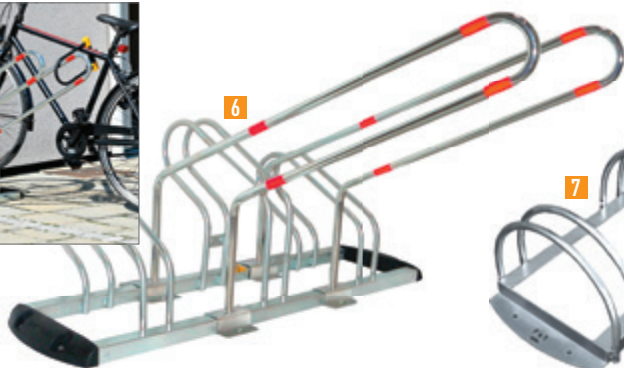

6 MONTANTI PER AGGANCIAMENTO BICI SU PORTABICICLETTE



Forniti con elementi di fissaggio (viti e tasselli). Utilizzo su area privata chiusa al pubblico. Compatibili con: ASR400, ASR500D, ASR001, ASR002. Trattamento anticorrosione: elettrozincatura. Dimensioni singolo montante mm 1020 x 974 x 780 h.

ASR1062K - 2 montanti, peso 7 kg

ASR1063K - 3 montanti, peso 9,8 kg

PORTABICICLETTE BUDGET

In ferro zincato a caldo, a 5 posti o a 3 posti con la possibilità di posizionamento delle biciclette da ambo i lati. Trattamento anticorrosione: zincatura a caldo. Sistema di fissaggio non incluso.

ASR002 - portabiciclette a 3 posti, peso kg 6,5

ASR001 - portabiciclette a 5 posti, peso kg 10,5

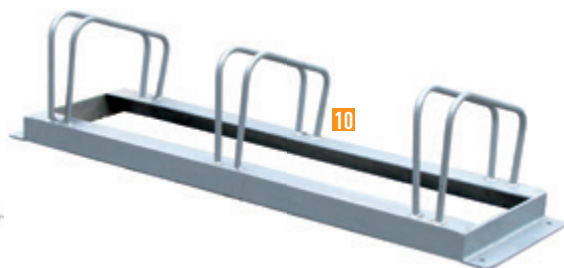

PORTABICICLETTE DI TIPO PESANTE

A più posti, di tipo pesante, realizzate in angolare 60 x 60 x 6 mm e tondino pieno Ø 14 mm di acciaio zincato a caldo. Fornite con 4 fori alla base per il fissaggio.

PBZ05 - portabiciclette tipo pesante, cm 230 x 35, 5 posti. Peso totale kg 34 circa

PBZ03 - portabiciclette tipo pesante, cm 130 x 35, 3 posti. Peso totale kg 24 circa



1



2



3



4

CONSEGNATE
IN 2 CARTONI



PANCHINE SENZA SCHIENALE

Panchina da fissare al terreno (elementi di fissaggio inclusi). In acciaio zincato a caldo e verniciato a polvere con resina poliesteri. Sopporta un peso di 250 kg, corrispondenti a 3 persone. Dimensioni (l x l x h) mm 1720 (1616) x 520 x 445 h. Consegnata in 2 cartoni.

- 1 **ASRP03N** - panchina senza schienale colore grigio scuro antracite
- 2 **ASRP03S** - panchina senza schienale colore grigio
- 3 **ASRP03BN** - panchina senza schienale bicolore (seduta effetto legno e fianchi grigio scuro)
- 4 **ASRP03BS** - panchina senza schienale bicolore (seduta effetto legno e fianchi grigi)



5



6



7



8

CONSEGNATE
IN 3 CARTONI



PANCHINE CON SCHIENALE

Panchina con schienale da fissare a terra (elementi di fissaggio inclusi). In acciaio zincato a caldo e verniciato a polvere con resina poliesteri. Sopporta un peso di 250 kg, corrispondenti a 3 persone. Dimensioni (l x l x h) mm 1720 (1616) x 590 x 815 (445) h. Consegnata in 3 cartoni.

- 5 **ASRP05N** - panchina con schienale colore grigio scuro antracite
- 6 **ASRP05S** - panchina con schienale colore grigio
- 7 **ASRP05BN** - panchina con schienale bicolore (seduta effetto legno e fianchi grigio scuro)
- 8 **ASRP05BS** - panchina con schienale bicolore (seduta effetto legno e fianchi grigi)



DISPENSER PER CARTA ASCIUGAMANI

Distributore a parete per carta asciugamani piegati a "Z" e "C".

- 1 **DCC0695** - distributore bianco, capacità 250 fogli, dimensioni mm 290 x 120 x 295
- 2 **DCC707** - distributore trasparente, capacità 250 fogli, dimensioni mm 300 x 105 x 290

3 CARTA PIEGATA A "Z"

Due veli pura cellulosa, dimensioni mm 240 x 230, 143 strappi. Minimo ordinabile 20 pezzi/multipli.
DCC1793 - carta a "Z"

4 DISPENSER DI CARTA ASCIUGAMANI

Dispenser a sfilamento interno, trasparente/bianco, capacità 1 rotolo. Dimensioni mm 166 x 185 x 293 h.
DCC582 - dispenser di carta asciugamani a sfilamento interno

5 ROTOLO CARTA ASCIUGAMANI

Due veli pura cellulosa, dimensioni m 57 x cm 22, 163 strappi. Minimo ordinabile 12 rotoli/multipli.
DCC1709 - carta asciugamani in rotolo



DISPENSER A TAGLIO AUTOMATICO HACCP

Dispenser per carta asciugamani capacità 1 rotolo. Dimensioni: mm 320 x 224 x 405 h.

- 6 **DCC780** - dispenser a taglio automatico
- 7 **DCC6937** - confezione da 6 rotoli di carta asciugamani m 100



DISTRIBUTORE PER SAPONE LIQUIDO CON EROGAZIONE A PULSANTE

- 8 **DCC0615** - distributore a parete bianco, capacità 1 lt, dimensioni mm 201 x 112 x 128
- 9 **DCC562** - distributore a parete trasparente, capacità 0,8 lt, dimensioni mm 250 x 95 x 95
- 10 **DCC831** - tanica da 5 lt di sapone per mani



11 ASCIUGAMANI ELETTRICO A FOTOCELLULA

Asciugamani elettrico a fotocellula con coperchio in plastica ABS colore bianco. Design e funzionalità in un unico prodotto realizzato in Italia con materiali di elevata qualità. Evita l'utilizzo della carta asciugamani. Fissaggio mediante viti e tasselli. Altezza di montaggio: 130-140 cm. Resistenza 950W.

DCC847 - asciugamani con motore 150W, dimensioni 258 x 138 x 145 mm



PORTABOBINE PORTATILE

Cavalletto a terra con ruote in ABS per rotolo industriale. Dimensioni cm 51,5 x 47 x 91 h.

- 1 DCC0638** - portabobine con ruote e coperchio HACCP
- 2 DCC0566** - portabobine con ruote bianco
- 3 DCC0578** - portasacco per portabobine DCC0566 (sacco escluso)

4 CESTINO GETTACARTA

In materiale plastico colore bianco, coperchio basculante, capacità 24 lt.

PSR24 - dimensioni mm 380 x 280 x 520 h



PORTABOBINE MURALE

Supporto pensile in ABS per rotolo industriale.

- 5 DCC0533** - portabobine murale bianco, cm 44 x 30,5 x 25
- 6 DCC0636** - portabobine murale bianco con coperchio HACCP, cm 33 x 34 x 44

7 ROTOLI INDUSTRIALI PER PORTABOBINE

Due veli pura cellulosa, colore bianco. Minimo ordinabile 2 rotoli/multipli.

- DCC1683** - rotolo 500 strappi, dimensioni m 137 x cm 23,5, Ø cm 22,4
- DCC7565** - rotolo 738 strappi, dimensioni m 177 x cm 23,4, Ø cm 25,5

DISPENSER PER SACCHETTI IGIENICI

- 8 DCC531** - dispenser capacità 60 sacchetti, mm 135 x 55 x 295 h
- 9 DCC942** - sacchetti igienici, minimo ordinabile 200 pezzi/multipli

PORTAROTOLO CARTA IGIENICA

- 10 DCC0588** - portarotolo colore bianco, Ø 320 mm, dimensioni mm 370 x 130 x 360 (h x p x l)
- 11 DCC7567** - confezione da 6 rotoli da 300 m ciascuno di carta igienica in pura cellulosa, 811 strappi



POSACENERE GETTACARTA AUTOESTINGUENTE

Corpo in ferro verniciato a polveri epossidiche. Testa, vaschetta superiore per contenimento sabbia (a corredo kg 1) e retina per lo svuotamento estraibili colore nero. Base in gomma antiscivolo, fondo a tenuta stagna.

- 1 PSR572** - posacenere gettacarta colore nero, Ø cm 25 x 80 h, peso kg 4,5, capacità lt 25
- PSR572.** - posacenere gettacarta Ø cm 25 x 80 h, peso kg 4,5, capacità lt 25. Colori: **S** grigio **R** rosso
- 2 PSR570** - posacenere gettacarta colore nero, cm 31 Ø x 80 h, peso kg 7,5, capacità lt 40
- PSR570.** - posacenere gettacarta Ø cm 31 x 80 h, peso kg 7,5, capacità lt 40. Colori: **S** grigio **R** rosso
- 3 PSR574** - posacenere gettacarta colore nero, cm 38 Ø x 90 h, peso kg 11, capacità lt 75
- PSR574.** - posacenere gettacarta Ø cm 38 x 90 h, peso kg 11, capacità lt 75. Colori: **S** grigio **R** rosso



CESTINI GETTACARTA AUTOESTINGUENTI

In ferro verniciato, testa di colore nero, con sistema interno di estinzione delle fiamme.

- 4 PSR546** - cestino colore nero, Ø cm 31 x 60 h, peso kg 2,9, capacità lt 40
- PSR546S** - cestino colore grigio, Ø cm 31 x 60 h, peso kg 2,9, capacità lt 40
- PSR546R** - cestino colore rosso, Ø cm 31 x 60 h, peso kg 2,9, capacità lt 40
- 5 PSR542** - cestino colore nero, Ø cm 38 x 75 h, peso kg 7,5, capacità lt 75
- PSR542S** - cestino colore grigio, Ø cm 38 x 75 h, peso kg 7,5, capacità lt 75
- PSR542R** - cestino colore rosso, Ø cm 38 x 75 h, peso kg 7,5, capacità lt 75



6 PORTA OMBRELLI/GETTACARTA

In ferro verniciato con vaschetta in plastica alla base, Ø cm 23 x 50 h. Peso kg 1,8, capacità lt 20.

PSR116 - portaombrelli/gettacarta colore nero

7 CESTINO GETTACARTA

Cestino gettacarta in ferro verniciato, Ø cm 24 x 40 h, peso kg 1,5.

PSR120 - cestino colore nero, capacità lt 15



1



2



IN ABBINAMENTO AL COLORE DELLA TESTA, VERRÀ FORNITO UN PITTOGRAMMA DELLO STESSO COLORE (COME RAFFIGURATO).



GETTACARTA MODULARI

Eleganti linee coordinate di gettacarta in ferro verniciato a polveri epossidiche, a pavimento con piedini in gomma nascosti. Disponibile in due forme modulari: triangolare e quadrata. In abbinamento al colore della testa verrà fornito un pittogramma dello stesso colore.

Colori: **S** grigio **R** rosso **Y** giallo **B** blu **G** verde

1 PSR632. - pattumiera forma quadrata con testa colorata, corpo colore grigio. Dimensioni cm 30 x 30 x altezza 80. Capacità 60 lt

PSR633. - pattumiera forma quadrata con testa colorata, corpo colore nero. Dimensioni cm 30 x 30 x altezza 80. Capacità 60 lt

2 PSR635. - pattumiera forma triangolare con testa colorata, corpo colore grigio. Dimensioni cm 30 x 30 x altezza 80. Capacità 60 lt

PSR636. - pattumiera forma triangolare con testa colorata, corpo colore nero. Dimensioni cm 30 x 30 x altezza 80. Capacità 60 lt



3

3 GETTACARTA PER LA RACCOLTA DIFFERENZIATA

Corpo e coperchio in acciaio verniciato, profili colorati per differenziare la raccolta, sistema reggisacco integrato. Ideale per creare isole ecologiche.

PRR007 - corpo colore nero, dimensioni: mm 300 x 200 x 700 (l x p x h) capacità 42 lt

PRR008. - coperchio colorato. Colori: **S** grigio **B** blu **Y** giallo **R** rosso **G** verde



4

4 POSACENERE GETTACARTA PER LA RACCOLTA DIFFERENZIATA

Modello **per esterni** realizzato in acciaio galvanizzato con verniciatura epossidica. Tre secchi interni zincati da 35 lt cad. (tot. capacità 105 lt). Etichette per raccolta differenziata incluse, posaceneri fissato con catenella, chiusura con chiave triangolare, fissaggio al suolo in 3 punti (viteria esclusa).

PRR004 - posaceneri gettacarta per esterni, Ø mm 490 x 1080 h, capacità 105 lt



POSACENERI E GETTACARTA PER INTERNI



1



2



3

1 POSACENERE DA PAVIMENTO

In acciaio verniciato, vaschetta superiore per contenimento sabbia (a corredo kg 1), retina per lo svuotamento. Dimensioni Ø cm 31 x 72 h. Peso kg 5,4.

PSR540 - posacenere, corpo colore nero

PSR540S - posacenere, corpo colore grigio

PSR540X - posacenere corpo in acciaio inox

2 POSACENERE GETTACARTA DA PAVIMENTO

Posacenere gettacarta da pavimento in acciaio verniciato, vaschetta interna estraibile. Dimensioni Ø cm 25 x 63 h. Peso kg 4.

PSR585N - posacenere gettacarta, corpo colore nero

PSR585S - posacenere gettacarta, corpo colore grigio

PSR585X - posacenere gettacarta, corpo acciaio inox

3 POSACENERE MURALE

Posacenere murale in metallo verniciato colore nero con ghiera superiore speggni sigaretta. Vaschetta interna estraibile, capacità 1,5 litri. Base con predisposizione per fissaggio a parete. Dimensioni cm 23,5 x 13,2 x 18,7 h. Peso kg 1,5.

PSR551N - posacenere murale



4



5



6

100 lt



60 lt

4 GETTACARTA CON POSACENERE

Gettacarta con posacenere da pavimento in acciaio verniciato. 1 kg di sabbia incluso. Anello in plastica inferiore antigraffio. Dimensioni Ø cm 24,3 x 66,5 h. Peso kg 3,7.

PSR584N - gettacarta con posacenere da pavimento, corpo colore nero

PSR584G - gettacarta con posacenere da pavimento, corpo colore grigio

5 POSACENERE DA PAVIMENTO

Posacenere da pavimento in acciaio verniciato. 1 kg di sabbia incluso. Anello in plastica inferiore antigraffio. Dimensioni Ø cm 31 x 72 h. Peso kg 5,5.

PSR540N - posacenere da pavimento, corpo colore nero

PSR540G - posacenere da pavimento, corpo colore grigio

6 POSACENERE GETTACARTA DA PAVIMENTO

Bidone gettacarta corpo colore nero, testa in metallo verniciato e coperchio superiore. Tagli laterali ideali per spegnere le sigarette. Il tubo contenente mozziconi di sigaretta è facile da rimuovere e svuotare.

PSR100NTP - gettacarta da pavimento capacità 100 lt, dimensioni cm 38 x 38 x 102 h, peso kg 13,5

PSR60NTP - gettacarta da pavimento capacità 60 lt, dimensioni cm 30 x 30 x 102 h, peso kg 10,5



POSACENERI A COLONNA E MURALI PER INTERNI ED ESTERNI



POSACENERE PER ESTERNO

Posaceneri in acciaio verniciato colore nero. Testa e griglia spegni sigaretta removibili, apertura e chiusura con serratura. Raccogliitore interno estraibile, capacità 2 litri.

- 1 **PME001N** - posaceneri murale da esterno, dimensioni cm 17,5 x 12 x 34 h, peso kg 3
- 2 **PTE001N** - posaceneri a colonna da esterno. Base con predisposizione per fissaggio a terra, dimensioni cm 17,5 x 12 x 106 h, peso kg 5.

POSACENERE A COLONNA PER ESTERNO

Posaceneri a colonna con testa e griglia spegni sigarette removibili, apertura e chiusura con serratura. Raccogliitore interno estraibile, capacità 3 litri. Base in metallo con copertura in plastica, predisposta per fissaggio a terra. Dimensioni Ø cm 11,7 x 105 h, peso kg 9,5.

- 3 **PSR701** - posaceneri a colonna in acciaio verniciato colore nero
- 4 **PSR701AS** - come sopra, in acciaio inox satinato

POSACENERE PER INTERNI

Posaceneri in alluminio verniciato a polveri epossidiche. Secchio interno, chiusura con chiave (A).

- 5 **PSR771** - posaceneri a colonna Ø cm 12 x 102 h, peso kg 9,5. Base Ø 34 cm
- 6 **PSR770** - posaceneri murale Ø cm 12 x 49 h, peso kg 2,1



7 POSACENERE PER ESTERNO

In acciaio verniciato con griglia asportabile per lo svuotamento. Base appesantita per una maggior stabilità. Ideale all'esterno di qualsiasi esercizio commerciale. Fornito con sabbia a corredo. Dimensioni: Ø cm 41 x 100 h. Peso kg 14.

PSR440 - posaceneri nero



8 POSACENERE MURALE PER ESTERNO

Posaceneri murale in acciaio inox satinato, griglia interna spegni-sigaretta, chiusura con chiave. Svuotamento tramite ribaltamento del portaceneri.

PRB04 - posaceneri murale Ø cm 13 x 64,5 h, peso kg 2,5

9 POSACENERE A COLONNA PER ESTERNO

In acciaio inox satinato. Secchio interno in acciaio inox con maniglia, chiusura con chiave, piedi di appoggio in plastica. Può essere fissato al suolo, base di appoggio Ø 30 cm.

PRB09 - posaceneri a colonna Ø cm 13 x 101 h, peso kg 5, capacità 4 lt





STAZIONI PER LA RACCOLTA DIFFERENZIATA



Linea Pure

Nuova gamma di contenitori porta rifiuti dalle linee pulite ed essenziali e un design elegante e funzionale. Unici e versatili, i contenitori sono disponibili sia come elementi singoli modulari che come stazioni polifunzionali, consentendo infinite combinazioni di forme e colori per adattarsi ed integrarsi in ogni contesto. La cover è personalizzabile con stampe e/o incisioni.



1 STAZIONE PER RACCOLTA DIFFERENZIATA 120 LT

Stazione contenitore per raccolta differenziata in lamiera di ferro zincato verniciato a polveri epossidiche. Incluso kit di 5 pratici pittogrammi magnetici sagomati, da attaccare e staccare per agevolare la pulizia e la manutenzione. Dimensioni cm 60 x 30 x 80 h. Peso 14 kg. Capacità 120 lt.

PSR120FN - stazione per raccolta differenziata 120 lt, colore nero
PSR120FG - stazione per raccolta differenziata 120 lt, colore grigio



2 STAZIONE PER RACCOLTA DIFFERENZIATA 180 LT

Stazione contenitore per raccolta differenziata in lamiera di ferro zincato verniciato a polveri epossidiche. Incluso kit di 5 pratici pittogrammi magnetici sagomati, da attaccare e staccare per agevolare la pulizia e la manutenzione. Dimensioni cm 90 x 30 x 80 h. Peso 21 kg. Capacità 180 lt.

PSR180FN - stazione per raccolta differenziata 180 lt, colore nero
PSR180FG - stazione per raccolta differenziata 180 lt, colore grigio



3 STAZIONE PER RACCOLTA DIFFERENZIATA 200 LT

Stazione contenitore per raccolta differenziata in lamiera di ferro zincato verniciato a polveri epossidiche. Incluso kit di 5 pratici pittogrammi magnetici sagomati, da attaccare e staccare per agevolare la pulizia e la manutenzione. Dimensioni cm 77 x 38 x 80 h. Peso 18 kg. Capacità 200 lt.

PSR200FN - stazione per raccolta differenziata 200 lt, colore nero
PSR200FG - stazione per raccolta differenziata 200 lt, colore grigio

SPESE DI TRASPORTO DA CONCORDARE

STAZIONE 300 LT, GETTACARTA MURALE E DA PAVIMENTO



300 lt

STAZIONE PER RACCOLTA DIFFERENZIATA 300 LT

Stazione contenitore per raccolta differenziata in lamiera di ferro zincato verniciato a polveri epossidiche. Spessore lamiera del fusto: 0,6 mm; spessore lamiera della cover: 2 mm. Cover dotata di fondino in acciaio zincato con funzione reggi sacco ad incastro sull'anello perimetrale in tecnopolimero posto all'interno del fusto. Incluso kit di 5 pratici pittogrammi magnetici sagomati, da attaccare e staccare per agevolare la pulizia e la manutenzione. Dimensioni cm 115 x 38 x 80 h. Peso 27 kg.

- 1 **PSR300FN** - stazione per raccolta differenziata 300 lt, colore nero
- PSR300FG** - stazione per raccolta differenziata 300 lt, colore grigio
- 2 **PSR300FBAG** - stazione per raccolta differenziata 300 lt con coperchi basculanti, colore grigio
- PSR300FBAN** - stazione per raccolta differenziata 300 lt con coperchi basculanti, colore nero



3

3 GETTACARTA MURALE

Gettacarte murale in metallo verniciato nero con elastico fermasacco. Fissaggio a muro (viti non incluse). Dimensioni: mm 395 x 195 x 388 h. Peso 3,7 kg. Capacità 20 lt.
PRR031 - gettacarte murale

Gettacarta da pavimento

Gettacarta in lamiera d'acciaio verniciato, adatto per l'uso quotidiano in spazi interni, robusto e facile da pulire. Grazie allo sportello basculante a chiusura automatica, i rifiuti sono inodori e nascosti alla vista. Secchio interno rimovibile in acciaio, con pratico anello di bloccaggio per i sacchi della spazzatura.



40 lt

4

4 GETTACARTA DA PAVIMENTO 40 LT

Dimensioni Ø cm 35 x 74 h. Peso kg 5,5.
PSR539W - gettacarta da pavimento colore bianco
PSR539N - gettacarta da pavimento colore nero
PSR539S - gettacarta da pavimento colore grigio



52 lt

5

5 GETTACARTA DA PAVIMENTO 52 LT

Dimensioni Ø cm 38 x 89 h. Peso kg 11.
PSR520N - gettacarta da pavimento colore nero
PSR520S - gettacarta da pavimento colore grigio
PSR520X - gettacarta da pavimento in acciaio inox



GETTACARTA DA PAVIMENTO



GETTACARTA DA PAVIMENTO 60 LT

Elegante e funzionale contenitore per la raccolta dei rifiuti in acciaio. Pratico reggisacco interno con svuotamento dall'alto. Incluso 1 pittogramma magnetico, da attaccare e staccare per agevolare pulizia e manutenzione. Dimensioni cm 30 x 30 x 80 h. Peso 7 kg. Capacità 60 lt.

- 1 **PSR60FN** - gettacarta da pavimento 60 lt, colore nero
- 2 **PSR60FG** - gettacarta da pavimento 60 lt, colore grigio
- 3 **PSR60FDG** - gettacarta da pavimento 60 lt, colore grigio
- 4 **PSR60FDN** - gettacarta da pavimento 60 lt, colore nero

GETTACARTA DA PAVIMENTO 100 LT

Elegante e funzionale contenitore per la raccolta dei rifiuti in acciaio. Pratico reggisacco interno con svuotamento dall'alto. Incluso 1 pittogramma magnetico, da attaccare e staccare per agevolare la pulizia e la manutenzione. Dimensioni cm 38 x 38 x 80 h. Peso 9 kg. Capacità 100 lt.

- 5 **PSR100FN** - gettacarta da pavimento 100 lt, colore nero
- 6 **PSR100FG** - gettacarta da pavimento 100 lt, colore grigio



GETTACARTA DA PAVIMENTO 100 LT

Elegante e funzionale contenitore per la raccolta dei rifiuti in acciaio. Pratico reggisacco interno con svuotamento dall'alto. Incluso kit da 5 pittogrammi magnetici, da attaccare e staccare per agevolare la pulizia e la manutenzione. Dimensioni cm 38 x 38 x 80 h. Peso 9 kg. Capacità 100 lt.

- 7 **PSR100CDN** - gettacarta da pavimento 100 lt, colore nero
- 8 **PSR100CDG** - gettacarta da pavimento 100 lt, colore grigio



GETTACARTA DA PAVIMENTO 100 LT CON COPERCHIO BASCULANTE

Elegante e funzionale contenitore per la raccolta dei rifiuti in acciaio con coperchio basculante. Pratico reggisacco interno con svuotamento dall'alto. Incluso 1 pittogramma magnetico, da attaccare e staccare per agevolare la pulizia e la manutenzione. Dimensioni cm 38 x 38 x 80 h. Peso 9 kg. Capacità 100 lt.

- 9 **PSR100FBAG** - gettacarta da pavimento 100 lt colore grigio
- 10 **PSR100FBAN** - gettacarta da pavimento 100 lt colore nero

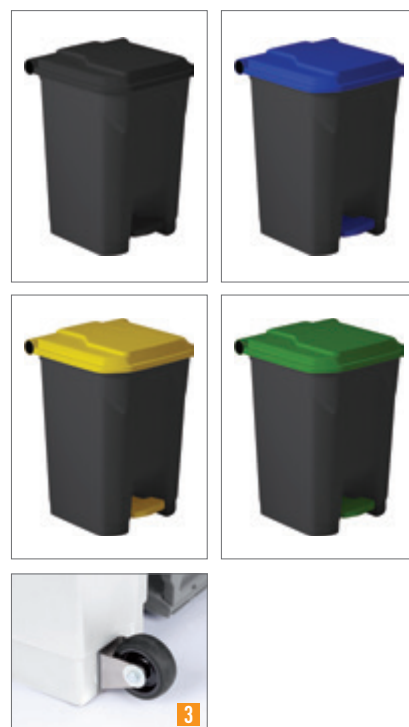

PATTUMIERE A PEDALE IN PLASTICA

Pattumiere con corpo in materiale plastico. Fornibili con coperchi in diversi colori: **N** nero **R** rosso **B** blu **Y** giallo **G** verde

- 1 PSR051N.** - pattumiera corpo nero, dimensioni 40,2 x h 60 cm. Peso kg 2,85, capacità lt 50 (specificare colore coperchio dopo il codice)
- 2 PSR052N.** - pattumiera corpo nero, dimensioni 49,3 x h 84 cm. Peso kg 4,8, capacità lt 100 (specificare colore coperchio dopo il codice)
- 3 PSR100** - kit ruote per pattumiera a pedale, capacità 100 lt



HACCP COMPATIBLE

NEW



APERTURA FUSTO A DUE GUSCI PER FACILITARE LO SVUOTAMENTO DEL SACCO.



CONTENITORE A PEDALE

Pattumiera con fusto e placca coperchio superiore, disponibile in due versioni e tre capacità. Coperchio esterno in plastica, elastico ferma sacco. Fondo in tecnopolimero e piedi e pedale posteriori d'appoggio in tubolare di metallo verniciato grigio. Ruote in plastica con perni.

- 4 PSR748** - contenitore colore bianco, dimensioni cm 47 x 37 x 96 h, peso 13 kg, capacità 110 lt
- PSR748X** - contenitore in acciaio inox, dimensioni cm 47 x 37 x 96 h, peso 13 kg, capacità 110 lt
- 5 PSR749** - contenitore colore bianco, dimensioni cm 47 x 37 x 83 h, peso 12 kg, capacità 90 lt
- PSR749X** - contenitore in acciaio inox, dimensioni cm 47 x 37 x 83 h, peso 12 kg, capacità 90 lt
- 6 PSR750** - contenitore colore bianco, dimensioni cm 47 x 37 x 70 h, peso 11 kg, capacità 70 lt
- PSR750X** - contenitore in acciaio inox, dimensioni cm 47 x 37 x 70 h, peso 11 kg, capacità 70 lt



A RICHIESTA. È POSSIBILE PERSONALIZZARE IL COPERCHIO DEI CONTENITORI A PEDALE. RICHIEDI UN PREVENTIVO!



PATTUMIERE A PEDALE E CON CARRELLO REGGISACCO



PATTUMIERE A PEDALE IN METALLO VERNICIATO O ACCIAIO INOX

Pattumiere in due versioni, con secchio interno in plastica e pedale per apertura coperchio.

- 1 **PSR3A** - Ø cm 16,7 x 27 h. Peso kg 1, in metallo verniciato colore bianco. Capacità 3 lt
- 2 **PSR3B** - Ø cm 16,7 x 27 h. Peso kg 1, interamente in acciaio inox. Capacità 3 lt
- 2 **PSR305** - Ø cm 20,3 x 28,4 h. Peso kg 1,3, in metallo verniciato colore bianco. Capacità 5 lt
- 3 **PSR305X** - Ø cm 20,3 x 28,4 h. Peso kg 1,3, interamente in acciaio inox. Capacità 5 lt
- 3 **PSR112** - Ø cm 24,8 Ø x 40 h. Peso kg 2, in metallo verniciato colore bianco. Capacità 12 lt
- 3 **PSR112X** - Ø cm 24,8 Ø x 40 h. Peso kg 2, interamente in acciaio inox. Capacità 12 lt
- 4 **PSR320** - Ø cm 29,2 x 44,5 h. Peso kg 2,6, in metallo verniciato colore bianco. Capacità 20 lt
- 4 **PSR320X** - Ø cm 29,2 x 44,5 h. Peso kg 2,6, interamente in acciaio inox. Capacità 20 lt
- 5 **PSR330** - Ø cm 29,2 x 64 h. Peso kg 3,5, in metallo verniciato colore bianco. Capacità 30 lt
- 5 **PSR330X** - Ø cm 29,2 x 64 h. Peso kg 3,5, interamente in acciaio inox. Capacità 30 lt



HACCP COMPATIBLE

PATTUMIERA A PEDALE CON CARRELLO REGGISACCO IN METALLO VERNICIATO O ACCIAIO INOX

Pattumiera a pedale con carrello reggisacchi disponibile in due modelli (a muro o a terra) e due versioni (in metallo verniciato bianco o acciaio inox AISI 430 lucido). Elastico ferma sacco, apertura a pedale, ruote in plastica con perni. Completano la gamma gli adesivi colorati da applicare sui coperchi.

- 6 **PSR406W** - carrello reggisacchi a terra con ruote in ferro verniciato colore bianco, dimensioni cm 55 x 60 x 94 h. Ø 40 cm. Peso kg 10
- 7 **PSR406X** - carrello reggisacchi a terra con ruote in inox satinato, dimensioni cm 55 x 60 x 94 h. Ø 40 cm. Peso kg 10
- 8 **PSR407** - reggisacchi a muro in ferro verniciato senza coperchio, dimensioni Ø cm 38 x 11 h. Peso kg 2,6 (viti non incluse)
- 9 **PSR408** - reggisacchi a muro in ferro verniciato, dimensioni Ø cm 41 x 11 h. Peso kg 2,6 (viti non incluse)
- 10 **ADE406** - adesivi colorati per coperchi. Colori: **R** rosso **Y** giallo **G** verde **B** blu





I CESTINI MILANO SI POSSONO FISSARE A MURO O SU PALO (VITERIA ESCLUSA).

1 CESTINO MILANO VERNICIATO

In acciaio galvanizzato con verniciatura epossidica colore verde, svuotamento tramite ribaltamento, fondo perforato per drenaggio liquidi, elastico fermasacco e piastra di fissaggio.

- PRR002** - gettacarte cilindrico senza palo Ø mm 290 x 390 h, capacità 22 lt
- STC6012** - paletto in ferro zincato non verniciato Ø mm 60 x 1200 h, con tappo in plastica
- CLM14219** - staffe per applicazione al palo da Ø mm 60 (necessari 2 pezzi)
- CLFC60** - fascette per applicazione staffe al palo da Ø mm 60 (necessari 2 pezzi)

2 CESTINO MILANO

Cestino Milano in acciaio zincato, trattato con vernice trasparente di protezione, svuotamento tramite ribaltamento, elastico fermasacco e piastra di fissaggio.

- PRR003** - gettacarte cilindrico senza palo Ø mm 290 x 460 h, capacità 35 lt
- STC6012** - paletto in ferro zincato non verniciato Ø mm 60 x 1200 h, con tappo in plastica
- CLM14219** - staffe per applicazione al palo da Ø mm 60 (necessari 2 pezzi)
- CLFC60** - fascette per applicazione staffe al palo da Ø mm 60 (necessari 2 pezzi)

3 CESTINO MILANO CON COPERCHIO

In lamiera di ferro forata zincata a caldo, verniciato internamente ed esternamente di colore grigio ferro micaceo. Predisposto sia per attacco a palo tramite bulloni passanti (palo da forare) sia per fissaggio a parete.

- PRB46** - cestino Milano con coperchio (senza palo), Ø 270 mm x 460 h, peso kg 6
- PRB46P** - palo zincato verniciato per PRB46 colore grigio ferro micaceo, Ø 60 mm x 120 h

CESTINO E DISTRIBUTORE DI SACCHETTI PER DEIEZIONI CANINE

Composto da:

- 4 PRR015C** - cartello completo di fascetta di fissaggio a palo da mm 60
- 5 PRR015S** - distributore di sacchetti (vuoto) in acciaio verde con chiave triangolare, capacità massima 600 sacchetti (collari esclusi).
- PRR015D** - sacchetti per deiezioni canine, ricarica da 100 sacchetti. Minimo ordinabile 10 ricariche/multipli
- 6 PRR020** - cestino in polietilene HDPE, base mm 55 x 745 h, capacità 50 lt (fascetta esclusa). Con chiave triangolare
- 7 STC6025** - palo in ferro zincato Ø mm 60 x 2500 h con tappo in plastica alla sommità
- PRR015** - coppia collari per applicazione distributore di sacchetti a palo Ø mm 60
- CLFC60** - fascette per applicazione a palo Ø mm 60 (necessari 2 pezzi)

CESTINO IN POLIETILENE

Composto da:

- 6 PRR020** - cestino in polietilene HDPE, base mm 55 x 745 h, capacità 50 lt (fascetta esclusa). Con chiave triangolare
 - 8 STC412** - palo in ferro zincato Ø mm 48 x 1200 h h con tappo in plastica alla sommità
 - CLFC48** - fascetta per pali Ø 48 mm con foro (necessari 2 pezzi) (B)
- In alternativa al palo Ø mm 48:
- STC6012** - palo in ferro zincato, Ø mm 60 x 1200 h, con tappo in plastica alla sommità
 - CLFC60** - fascetta per pali Ø mm 60 con foro (necessari 2 pezzi) (B)



PALO IN ACCIAIO GALVANIZZATO COLORE VERDE Ø MM 60 X 2300 H (CODICE PRR015P) FORNIBILE A RICHIESTA.



BIDONI, CARRELLO, TRESPOLO E SACCHETTI PORTARIFIUTI



1 BIDONI PORTARIFIUTI ECOLINE

Bidone portarifiuti Ecoline con corpo e coperchio in polietilene grigio scuro, fissati con cerniera. Disponibili in due capacità: 80 o 100 lt.

PBI080 - bidone portarifiuti Ecoline, dimensioni Ø cm 45 x 70 h, capacità 80 lt

PBI100 - bidone portarifiuti Ecoline, dimensioni Ø cm 45 x 80 h, capacità 100 lt

2 TRESPOLO PORTASACCHI

Trespolo in metallo zincato a caldo, con coperchio. Peso kg 10 circa. Dimensioni: Ø superiore cm 38, Ø inferiore cm 50, altezza cm 85.

PRT08 - trespolo portasacchi in metallo

TRESPOLO IN PLASTICA CON COPERCHIO E REGGISACCO

Leggero e robusto, con coperchio e anello reggisacco. Dimensioni: Ø 51 cm x 85 cm altezza (Ø superiore 38 cm). Lavabile e sterilizzabile. Capacità 110 lt. Peso kg 2,8.

3 PRB087S - trespolo corpo colore grigio. Aggiungere dopo il codice la lettera del colore del coperchio desiderato: **R** rosso **Y** giallo **G** verde **B** blu

4 PRB087G - trespolo colore verde

5 PRB087S - trespolo colore grigio



6 BIDONI IN POLIETILENE

Corpo con manici per una facile presa, coperchio staccato dal corpo. **A richiesta fornibili verdi (minimo ordinabile 12 pezzi/multipli).**

Colori: **N** nero **W** bianco **G** verde

BIC050 - bidone capacità 50 lt, altezza 48 cm, bocca Ø 44,5 cm, fondo Ø 34 cm

BIC075 - bidone capacità 75 lt, altezza 64 cm, bocca Ø 44,5 cm, fondo Ø 34 cm

BIC121 - bidone capacità 120 lt, altezza 79 cm, bocca Ø 52 cm, fondo Ø 41 cm

7 BIDONE CON CHIUSURA AD ANELLO

In polietilene ad alta densità, colore bianco, idoneo per l'industria alimentare. Chiusura ad anello in acciaio zincato completo di guarnizione in silicone idonea al contatto alimentare, non a tenuta stagna.

PRM807 - bidone h 57,5 cm, capacità 75 lt

PRM810 - bidone h 67,2 cm, capacità 100 lt

SACCHI PORTARIFIUTI COLORAZIONI TRASPARENTI

8 PRS110 - confezione da 20 sacchi portarifiuti in HDPE, capacità 110 lt. Colori: **V** viola **Y** giallo **G** verde **N** neutro

9 PRS030B - confezione da 20 sacchi portarifiuti in HDPE, colore azzurro capacità 30 lt

10 PRS240N - confezione da 100 sacchi portarifiuti in LDPE, colore nero, capacità 240 lt (a richiesta)

11 CARRELLO PER BIDONI

Carrello regolabile per bidoni da 75 (base Ø 40) e 100 lt (base Ø 43). Realizzato in polipropilene grigio, portata superiore a 100 kg, dotato di 4 ruote pivotanti in materiale plastico di cui 2 dotate di freno autobloccante.

PRM1901 - carrello predisposto per 2 alloggiamenti



CASSONETTI PORTARIFIUTI A 2 RUOTE



CASSONETTO A 2 RUOTE DA 120 E 240 LITRI

Disponibile in 7 colori, con ruote in gomma piena da Ø 200 mm. Prodotto in polietilene ad alta densità di prima scelta (PE - HD), resistente agli agenti chimici, non attaccabile dai parassiti, non assorbe assolutamente i liquidi, è lavabile e sterilizzabile. Fornito smontato. Idoneo ad essere svuotato dai tipi di dispositivi di sollevamento attualmente in servizio (mediante attacco frontale a pettine tipo A).

Colori: **W** bianco (simile RAL 9003) **B** blu (simile RAL 5005)
G verde (simile RAL 6011) **M** marrone (simile RAL 8025)
Y giallo (simile RAL 1023) **R** rosso (simile RAL 3020)
S grigio (simile RAL 7016)

- 1 BIC0120.** - cassonetto 120 lt; peso kg 9; carico utile kg 60
- BIC0240.** - cassonetto 240 lt; peso kg 13; carico utile kg 116
- 2 BIC12** - anello fermasacco per cassonetti BIC0120
- BIC24** - anello fermasacco per cassonetti BIC0240

DIMENSIONI CASSONETTO CON COPERCHIO PIANO

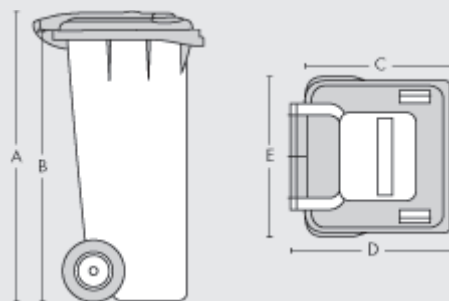

CODICE	A	B	C	D	E
BIC0120.	930 mm	875 mm	485 mm	550 mm	480 mm
BIC0240.	1070 mm	995 mm	655 mm	730 mm	580 mm
BIC0360.	1098 mm	1010 mm	601 mm	880 mm	580 mm

i TUTTI I CASSONETTI DI QUESTA PAGINA SONO CERTIFICATI DA TUV IN ACCORDO A NORME UNI EN 840 1 - 5 - 6, IN ACCORDO A DIRETTIVA 2000/14/CE (EMISSIONI INFERIORI A 97 dB. IL LIVELLO DI RUMOROSITÀ È RIPORTATO SULLA PARTE A VISTA DEL COPERCHIO.



! A RICHIESTA FORNIBILI CASSONETTI PER RACCOLTA DI CARTA, VETRO E PLASTICA.

3 GRUPPO PEDALIERA PER CASSONETTI DA 120 E 240 LITRI

I cassonetti da 120 e 240 lt sono predisposti per essere completato con gruppo pedaliera - kit pedale + anello fermasacco per bidone - di semplice applicazione (non è necessaria foratura).

- BIC120P** - gruppo pedaliera per cassonetti BIC0120
- BIC240P** - gruppo pedaliera per cassonetti BIC0240

4 CASSONETTO A 2 RUOTE DA 360 LITRI

Cassonetto con 2 ruote in gomma piena da Ø 200 mm, disponibile in 5 colori. Prodotto in polietilene ad alta densità di prima scelta (PE - HD), resistente agli agenti chimici, non attaccabile dai parassiti, non assorbe assolutamente i liquidi, è lavabile e sterilizzabile. Fornito smontato. Idoneo ad essere svuotato dai tipi di dispositivi di sollevamento attualmente in servizio (mediante attacco frontale a pettine tipo A). Carico utile kg 160.

Colori: **W** bianco (simile RAL 9003) **B** blu (simile RAL 5015/17)
G verde (simile RAL 6011) **M** marrone (simile RAL 8024)
Y giallo (simile RAL 1021)

- BIC0360.** - cassonetto 360 lt, peso kg 19





BIDONI E CASSONETTI PER LA RACCOLTA DIFFERENZIATA



BIDONI 100 LITRI PER LA RACCOLTA DIFFERENZIATA

Realizzati in polipropilene riciclabile, particolarmente adatti per utilizzo interno in tutti gli ambienti quali magazzini, uffici, comunità, negozi, ecc. Coperchi con chiusura a clip, maniglia ergonomica e rinforzata per facilitarne il trasporto. Aggancio esterno ai 4 angoli per sacco rifiuti, ruote e assali premontati con bloccaggio delle ruote. Alta scorrevolezza delle ruote antisdruciolio per maggior agiatezza nello spostamento. Facilmente impilabile con ruote montate. Ruote Ø 143 mm. Peso 3,8 kg. Aggiungere la lettera del colore del coperchio dopo il codice:

R rosso **Y** giallo **G** verde **B** blu

1 PRM100 - portarifiuti corpo colore grigio con coperchio piano (aggiungere la lettera del colore desiderato dopo il codice). Dimensioni 540 x 490 x 850 h

2 PRM101G - portarifiuti corpo colore grigio con finestrella basculante (aggiungere la lettera del colore desiderato dopo il codice). Dimensioni 540 x 490 x 950 h



ADESIVI DI SEGNALAZIONE CASSONETTI A PAGINA 215.



CASSONETTI A 4 RUOTE

In polietilene alta densità (HDPE). Resistente ai prodotti chimici, ai grandi sbalzi di temperatura, assorbe gli urti. Tappo di scarico per una facile pulizia, 4 ruote Ø 200 mm di cui due con freno a pedale. Concepiuti per essere svuotati da molti tipi di dispositivi di sollevamento attualmente in servizio (tipo DIN + rastrelliera).

Colore verde, peso kg 58, carico utile kg 450. *Fornibile a richiesta nei colori:*

G grigio antracite (simile RAL 7016) **Y** giallo (simile RAL 1021) **B** blu (simile RAL 50015/17) **M** marrone (simile RAL 8024) **W** bianco (simile RAL 9016)

3 BIC1001S - modello lt 1100, **coperchio piano per rifiuti solidi**

4 BIC1100U - modello lt 1100, **versione con coperchio basculante**

5 BIC1000P - gruppo pedaliera per cassonetti a 4 ruote (optional)

CASSONETTO CON COPERCHIO PIANO (mm)

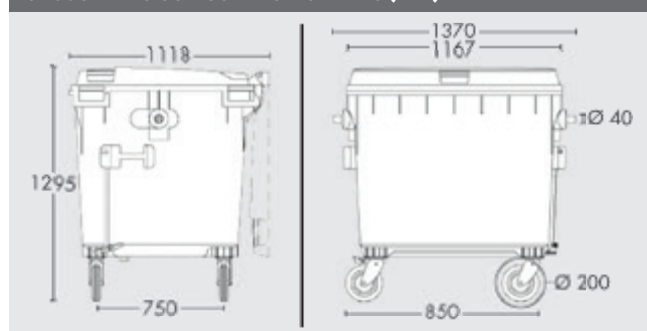

CASSONETTO CON COPERCHIO BASCULANTE (mm)

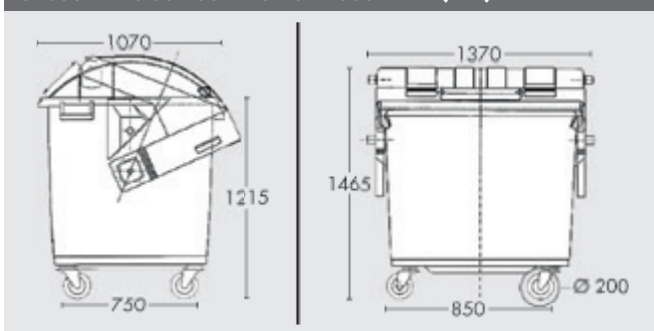



safeIn®

OGNI PROBLEMA HA LA SUA SOLUZIONE



ASSORBENTI INDUSTRIALI IN KIT

In caso di fuoriuscite accidentali di sostanze pericolose e inquinanti, gli assorbenti industriali SafeIn® sono la soluzione più semplice e immediata da utilizzare. Sversamenti, perdite e gocciolamenti durante la movimentazione e lo stoccaggio di sostanze pericolose, risultano essere una delle cause principali di inquinamento di terreni e falde acquifere. Realizzati in fibra di polipropilene altamente assorbente, gli assorbenti industriali SafeIn® ti garantiranno un risultato efficace nelle operazioni di ripristino di qualsiasi ambiente di lavoro.



OLEOASSORBENTI
COLORE BIANCO



UNIVERSALI
COLORE GRIGIO



CHIMICI
COLORE GIALLO

INDICE DEI CODICI

1.../E1...

102.....	139,140,146
103.....	141
11.....	28
119.....	28,146
121.....	146
122.....	146
13.....	44,45,54,55,154
15.....	72,76,77,79,83,131,154
15..Bl.....	80
15..BFL.....	81
159.....	131
16.....	79,83,132
17.....	30,31,32,33,34,35
18.....	56,57,58,59,60,61,62,63
19.....	46,47,48,49

2.../E2...

20.....	72,73,77,79,131,146,154
20..Bl.....	80,81
21.....	113,133,163,164,166,167
22.....	113,164
23.....	131,133,157,166
25.....	156
26.....	51,128,130,140,141,157,167
27.....	39,40,41,140,164
280.....	134
281.....	134
282.....	134
283.....	134,495
285.....	135
286.....	135
29.....	67,68,69,70,134,167

3.../E3...

30.....	156
31.....	51,128,129,130,131,146,166,167
33.....	135,140,164,165,169,170
34.....	165
35.....	39,67,68,69,70,134,163,167,169,495
36.....	134,136,137,138,140
37.....	134,136,137,138,140,141,146
38.....	123,125,127,134,139,140,141

4.../E4...

40.....	36,37,38
41.....	36,37,38
43.....	134,135,140,167
44.....	38,495
45.....	67,122,134,136,139,140,157
47.....	135
48.....	132,134,135,167,169
49.....	116,117,118,123,146

5.../E5...

55.....	133,169
56.....	134,135,154,158,159,160
56.....	161,162,164
57.....	283

6.../E6...

61.....	50,64
62.....	50,51,64,65,66,67
63.....	50,51,64,65,66,67
64.....	331,332
66.....	331
68.....	168

7.../E7...

715.....	78,79
715..BFL.....	81
720.....	78,79

73.....	141,146
76.....	141,146
77.....	133
78.....	133
79.....	133

8.../E8...

80.....	133
82.....	333
85.....	169
86.....	209
89.....	209

9.../E9...

900.....	208
908.....	209
91.....	123,140,143,144,145
93.....	121
937.....	208
94.....	122,213,215,329,330,332,495
95.....	114,115,495
96.....	154,155,170,171
97.....	123,171,332,495
98.....	145
99.....	124,125,126,127
9M.....	143

A...

ADE.....	532
AGK.....	133,296,299
AGV.....	272
AOV.....	272
AOS.....	272
AJ.....	501
AMS.....	494,495
ANC.....	367,421,422,423
ANC.....	425,426
AP.....	340,341,345,346,360,361
AP.....	370,377,378,428,495
APB.....	363,368,379
APE.....	360,361
APEK.....	366
APH.....	362,369
APL.....	378
APM.....	342,347
APT.....	361
APS.....	345
APU.....	378,370,374,375,376,378
ARA.....	479
ARB.....	230,231,518,519
ARF.....	499
ARG.....	499
ARR.....	477,478,479
AS.....	307,308
ASB.....	512,513,514
ASC.....	512,513,514
ASO.....	510,511,514
ASU.....	510,511,514
ASR.....	307,308,520
ASRP.....	521
AST.....	178,323,355,432,465
ASV.....	307
AUS.....	507
AX.....	500

B...

BAC.....	293,294
BAE.....	323
BAI.....	323
BAPE.....	323
BAR.....	304,305,308,310,318
BARD.....	304
BARV.....	222,223,224,225,298
BARV.....	302,303,304,306,308
BARS.....	304,305
BC.....	295,298

BEG.....	302
BES.....	302
BFL.....	302
BG.....	298,324
BGP.....	302
BGZ.....	302
BIC.....	534,535,536
BM.....	250
BON.....	445
BPS.....	327,468
BR.....	389
BRA.....	435,436,437,438,440,441
BRB.....	445,446,480
BRC.....	442,443,444,445
BRM.....	389
BRO.....	435
BRP.....	436,437,438,439
BRV.....	327,435,436,437,438,439,440,441
BSL.....	295
BTR.....	302
BUG.....	448
BUK.....	448,480
BUS.....	234,243

C...

CBC.....	273
CBK.....	292
CD.....	427
CE.....	323
CEA.....	323
CEG.....	323
CEN.....	463
CJ.....	501,502,503,505
CJP.....	505
CLC.....	292,533
CLF.....	292,533
CLM.....	292,533
CLP.....	292,533
CLS.....	292,533
CLP99.....	124,126
CMA.....	299,444
CMN.....	464,465
CMR.....	464,465
CML.....	293
CN.....	297
CNC.....	297
CNP.....	205
CNS.....	287
CNV.....	192,296,297,299
CO.....	310
COM.....	484,496
COR.....	310,311
CORV.....	310,311
COT.....	309
CP.....	296
CPE.....	463
CPK.....	133
CPL.....	235,236,237,238
CPS.....	237,442,443,444,445,446,447,449
CR.....	250
CRA.....	432
CRG.....	412,413
CSC.....	441,473
CSH.....	294
CSR.....	294
CT.....	215,325
CTG.....	325
CTM.....	325
CUE.....	163
CUS.....	381
CV.....	291
CVG.....	290
CVL.....	291
CVP.....	291
CVS.....	291
CVV.....	291

D...

DAM.....	424
DAN.....	220

DAT	309,313
DATV	306,312
DCC	522,523
DEF	447
DFR	311
DFS	309,311
DIS	295
DLA	294
DLM	294
DM	199,200,429
DS	187

E...

E103	141
E11	28,29
E119	29,146
E122	146
E13	44,45,54,55
E15	72,76,77
E15...BI	80,81
E15...BFL	81
E20...BI	80,81
E17	30,31,32,33,34,35
E19	46,47,48,49
E61	50,51,64
E62	64,65,66,67
E63	64,65,66,67
E715...BFL	81
EAC	370
EAPS	460
EB	272,273
ECAC	462
ECAS	462
ECAP	205
ECCS	461
ECPK	461
ECSC	461
EDS	239,268,269,395,404,405,407,426
EF	120,156
EEF	120,156
EL120	90
EL13	89,150
EL15	86,87,88,150
EL16	89,150
EL17	89,150
EL18	89
EL20	86,87,88,150
EL29	89
EL35	89
EL715	85
EL720	85
EL91	88
ELAS	271
ELC	370
ELE	365,366,367,368,369,370
ELF	368,369
ELN	369
ELS	368,369
ELV	369
EOCAP	461
EOCB	461
EOKB	327,460
EOIB	460
EOKF	460
EORP	460
EPB	461
EPSM	461
ESO	269
ESV	371

F...

F.080	284
F.100	284
F.160	280
F.162	285
F.190	280
F.193	280
F.24	278,279
F.26	278,279
F.29	278,279
F.460	280
F.490	280
F.493	280
F.501	279
F.502	279

F.503	279
F.530	284
F.548	284
F.57	283
F.70	283
F.6	284
F.7	284
F.641	282
F.660	282
F.661	282
F.662	285
F.691	282
F.693	287
F.741	283
F.760	282
F.761	283
F.762	282
F.790	282
F.80	285
F.802	294
F.807	284
F.808	284
F.816	285
F.818	285
F.82	285
F.820	285
F.83	285
F.901	281
F.902	281
F.911	281
F.912	281
F.913	281
F.914	281
F.921	281
F.922	281
F.923	281
F.56	158,159,160,161,162
F.68	168
FAB	285
FAH	278,279,280,281,282,284,287
FAL	469
FAP	466,468,469
FAR	158,159,160,161,162,278
FAR	279,281,282,284,285
FBA	480
FBR	480
FBEN	480
FCH	286
FCR160	286
FCR190	286
FCR532	286
FCR56	286
FCR661	286
FCR790	286
FCR80	285,286
FCR807	286
FCR808	286
FCR82	285
FCR83	285
FCR820	287
FCR912	286
FCR914	286
FCR922	286
FE	456,457,458
FEX	457,458
FER	454,455
FIB	319
FID	319
FIP	319
FIM	319
FIR	319
FIT	204
FIS	295
FL922	83
FLH	278,279,280,281,282,284
FLR	158,159,160,161,162
FLR	278,279,282,281,284,285,294
FRE	429
FRF	429
FRM	429
FRS	429
FSA	292
FSN	292
FSNUT	292

G...

GA	382,406
----	---------

GBR	327,388
GC	403
GD	427
GDRD	383
GE	380,403,404,405,406
GE	407,408,409,411
GEE	402
GEH	406
GEK	410,411
GER	402,403,405,408,410,443,495
GK	405
GKU	402,404,405
GP	407

H.../I.../J...

HSB	234
HSC	228,230
HSP	226,227,229
HSS	228
INFO	174
JCT	480

K...

KGV	174
KGO	174
KIT15	146
KIT20	146
KPC	334

L.../EL...

L15	86,88,92
L20	88
L16	87,89
L29	90
L35	90
L9	88
L905	90
L91	88,90
L910	90
L92	90
L93	91
L94	88,90
L95	90
L97	92
L98	92
LA	250
LAB	324,465,466
LABM	465
LABG	466
LABN	466
LAF	326
LAP	326
LAL	326
LANSARC	430
LAS	294,324,325,326
LCV	478,479
LOC	470,471,472
LP	250
LR	246,247,248,249,326,371
LVD	451,452,453
LVRIC	452

M...

MAK	244,245
MAR	325
MAVE	322
MCC	463,464
MCN	466
MCR	465
MCS	465
MED	357
MEGK	467
MET	464
MEW	465,466
MGG	230,232,233
MOT	291
MS	291,326
MSN	250
MTS	240,241
MU	257

N...

NB...	201
NBTF	121
NBTN	121
NC	212,213
NDRA	256
NEB	204
NJT	309
NP	202
NPS	119
NR	202,215
NS	202,203,204,210,211
NSA	495
NSP	203
NSR	202,330
NTS	199
NVP	229,300,301

O...

OR	170
ORV	170
OSC	246,295,469,473
OVERDRUM	486

P.../Q...

PAA	298,299
PAB	298,519
PAC	293
PAG	293
PAF	298
PAN	506
PAP	141,296
PAS	298
PASV	318
PAV	306
PAX	298
PBI	534
PBZ	520
PC	348,349
PCL	316,317
PCLT	316,317
PCS	352,353
PD	428
PDT	261
PDC	261,262,263,264,265,266,267,313
PEN	323
PF	347,350
PGE	216,217
PGJ	219
PGR	314,315,317
PGRV	222,223,224,306,312
PGRV	314,315,317,318
PGV	218,219
PHM	347
PIINZ	234
PM	271,349,350,527
PMO	271
PMS	271
PMT	271
PN	273,287,329,331
PNK	328,329,330,331
PNH	287,329
PNM	330
PNR	330
PNT	329
PO	288,289
PP	167,214,215
PPS	167,214,215
PRB	498,527,534
PRM	534,536
PRO	258,259
PRR	525,529,533
PRS	534
PRT	534
PS	482,485,486,487,489,490,491
PSA	483,485,486,487,488,489,490
PSA	491,492,493,496,497,498
PSAC	498
PSC	446
PSE	462
PST	462
PSJ	504
PSR	523,524,525,526,527,528

PSR	529,530,531,532
PSS	295
PT	527
PWTT	384,385
QDT	306

R...

R3	202
R56	158,159,160,161
R57	283
R80	330
R94	215,329
R96	330
RA	250
RBT	429
RMT	429
RC	293
RLM	305
RIP	260
ROC	256
RSD	343,344,354,355,356,357,432
RSS	352,353

S...

SA	291
SAC	513
SAF	466
SB	432
SBV	432,441
SC	206
SEC	100,101,102,103,180
SEM	105,106,107,108,109,173,180
SEMS	173
SEP	82,83,95,96,97,98,99
SEP2	82
SEP715	82
SERIE 2000	347
SERIE 5000	347
SERIE 6000	347
SFL	207
SGE	242,243
SGT	204
SIC	110,111,112
SMAT	178,185,193,205
SMBT	178,179
SMBQ	179
SMCA	181,182,183,184
SMCT	175,178,180,185,187
SMET	176,177,186
SML	178,179
SMLT	179,185
SP	320,321
SR	283
STC	293,294,533
SUP	323
SWB	178
SWA	255
SWC	255
SWE	255
SWD	252,253
SWN	255
SWS	255
SXD	21,207
SXT	21,207
SXNET	124,126
SZ	294

T...

TAA	382,406
TACP	383,386,387
TAN	504
TAS	380,381,406
TAX	386
TCK	370,398
TDC	175,180
TDV	192
TEXAS	464
TF	346
TI	428
TKLI	174,180
TKP	174,176,177
TKP	180,185,187

TKS	173
TKT	187
TLA	430
TLF	430
TLG	430
TLT	430
TLK	430,431
TLS	430
TM	346,347
TN	322,326
TNI	371,474,475,476
TP	428
TPA	265,266
TPE	476
TPJ	267
TPU	234,239
TRI	327
TRR	430
TRT	430
TRS	303
TS	287,303
TSS	303
TSA	188,189
TSO	188,189
TSE	188,189
TSB	188,189
TSM	190,191
TSK	193
TSP	188,193,302
TST	190
TTB	398
TTM	399
TV	365,366,367,368
TYV	397,398,495

U...

U97	115
UAB	515
UAS	515
UAT	516
US	516
UCS	515
UTP	379

V...

VEU	113
VPA	387,388
VPC	389
VPP	389
VPG	393
VPS	391
VPSP	392,394
VPSI	394
VPSS	390
VPU	405

Y.../EY...

Y..16	150
Y..17	148
Y..18	147
Y..19	148
Y..20	150
Y..27	148
Y..26	171
Y..49	123
Y..91	123,143
Y..95	149
Y..96	171
Y.LS15.../Y.LS16	150
Y.LS20	150

Z...

ZC	389,417,419
ZCD	427
ZCH	418,467
ZCI	379,419
ZCP	416
ZCR	419
ZCS	415

MAGGIORI
INFORMAZIONI ALLE
PAGINE 210 E 211



for a **safe industry**



VERSIONE FLUO
DA CANTIERE!



LINEE SEMPRE PERFETTE

VERNICE TRACCIALINEE PER MARCATURA

Ideali per aree di stoccaggio, magazzini, parcheggi, aree produttive e piste ciclabili, le bombolette di vernice spray Safe In® sono disponibili in diversi colori. Di facile utilizzo, delimitano le superfici e ottimizzano la circolazione in ambienti interni ed esterni. Resistenti all'usura e alle intemperie, asciugano rapidamente (15-20 minuti) aderendo a tutte le superfici. Vai alle pagine 210 e 211 per maggiori informazioni!

Disponibili in 6 colori:



INDICE DEGLI ARTICOLI

A

Abbigliamento (alluminizzato)	382,480
Abbigliamento (alta visibilità)	327,384-389
Abbigliamento (anticalore)	382
Abbigliamento (antipioviggia)	389
Abbigliamento (da lavoro)	380-394
Abbigliamento (ignifugo)	383,384,389
Abbigliamento (intimo)	394
Abbigliamento (monouso)	395-397
Abbigliamento (multirischio)	383,384,386
Abbigliamento (protezione chimica)	383
Abbigliamento (saldatura)	380,381
Adesivi per cassonetti	215
ADR (borsa kit)	327
Agriturismo (cartelli di indicazione per)	283
Allarme personale per elmetti	370
Allarme incendio (dispositivo)	469
Alluminizzato (abbigliamento)	382,480
Alluvioni (barriera contro le)	507
Amianto (cartelli)	134,332,495
Amianto (stoccaggio)	494-495
Anelli di giunzione	133,296,299
Angolari paracolpi	216,217,218,316
Anticaduta (dispositivi e sistemi)	420-426
Anticaduta (kit)	424,425
Anticalore (abbigliamento)	382
Antifatica (tappeti)	262-265
Angoli adesivi per pavimento	200-201
Antincendio (attrezzatura varia)	466-468
Antintrusione (dispositivi)	257
Antirumore (archetti)	361,363
Antiscivolo (nastri)	252-255
Antiscivolo (prodotti)	255
Antiscivolo (strisce e angolari)	253
Antistatico (camice)	383
Antiustione (prodotti e kit)	441,448
Apparecchi ventilazione assistita	353,356,357
Apribocca elicoidale	444
Archetti antirumore	361,363
Archetti antisosta	307,308
Arco elettrico (indumenti per)	383
Aree estese (illuminazione per)	249
Armadi antincendio	477-479
Armadi di stoccaggio	499-501
Armadi per autorespiratori	355
Armadi (per D.P.I.)	432
Armadietti spogliatoio	518,519
Armadietti di medicazione	435-441
Arredamento per infermerie	449
Asce	468
Asta di marcaggio Safe In®	211
Asta per bandiere	323
Asciugamani elettrico	522
Assorbitori per acido solforico	506
Assorbitori Safe In® per sversamenti	508-514
Aste millimetriche e graduate	272
Astucci di primo soccorso	440,448
Atex (torce antideflagranti)	474,475,476
Autorespiratori	351,352,354,355

B

Bacheche	178-179
Badili	468
Banchine (paracolpi per)	318
Bandiere	323
Bandierine segnaletiche	295
Barelle	446
Barra appendifogli da parete	175
Barre di delimitazione parcheggi	316
Barrette luminose	322
Barriere	300,302-306,309,507,515
Barriere flessibili in polietilene	220-221
Barriere aree industriali	220-225,257,258,259
Barriere manuali	305
Basi	293,295,297,298
Basi in cemento	295,298

Basi per colonnine	297
Battiruota	317
Bauli	234
Bende	443
Benne portarottami	496
Berretto con luce	395
Bidoni portarifiuti	525-531,534-536
Big bag (sacchi per amianto)	494
Bilancia contapezzi	230
Bloccaggio (dispositivi di)	470-472
Boette fumogene e luminose	473
Bollini colorati in rotolo	204
Bollini datario	273
Bombole (cartelli per)	123
Bombole a gas (movimentazione)	491
Bombolette Safe In®	210-211
Bordo macchina (cartelli)	116-118
Borsa ADR	327
Borsa antincendio kit	468
Borsa Emergency	440
Borsoni (vuoti)	327,468
Boscaiolo (abbigliamento)	379
Box (per bombole)	491
Box (per stoccaggio sostanze)	489,492,493
Box mobili per la saldatura	431
Bracciali retroriflettenti	389
Buste di sicurezza	234,243
Buste e cartelline trasparenti	182-183,234

C

Calotte (di protezione)	379
Calzatoia	334
Calzari	382,398,480
Calze da lavoro	394
Camicie e camici	383,389,391
Camion (articoli per)	334
Campana antincendio	469
Cancello di sicurezza	257
Cantieri (segnaletica per)	286-287
Cappellini di sicurezza	370
Cappucci di protezione per estintori	461
Cappuccio	381,382
Cappuccio di fuga	352,355
Cargopallet	237
Carrelli antincendio	462
Carrelli manuali di trasporto bombole	489,491
Carrelli per magazzini	230
Carrelli portafusti	462
Carrello portabidoni	534
Cartelli (lettere e numeri)	208-209
Cartelli antincendio	72-73,83
Cartelli applicazione palo	165
Cartelli "Attenti al cane"	169
Cartelli ausiliari	146
Cartelli bifacciali	80-81
Cartelli bordo macchina	116-118
Cartelli CER e per raccolta rifiuti	165
Cartelli di chiusura turno settimanale	170
Cartelli di divieto	54-67,278
Cartelli di emergenza	76-79,83
Cartelli di indicazione	168,283,284
Cartelli di informazione vari	128-135
Cartelli di obbligo	44-51,279
Cartelli di pericolo	28-41,280
Cartelli linea "Colorfix"	110-112
Cartelli linea "Crystal"	100-103
Cartelli linea "Metal"	104-109
Cartelli linea "Plexi"	95-99
Cartelli orario di lavoro	135
Cartelli per caccia e pesca	165
Cartelli portata funi/catene	135
Cartelli scale mobili	135
Cartelli serie "Qualità"	157
Cartelli Easy Fix	120
Cartelli fotoluminescenti "Din Plus"	84-89,150
Cartelli fotoluminescenti I.M.O.	92
Cartelli in lingua straniera	147-150,171

Cartelli in lingua straniera per interni	171
Cartelli in lingua straniera serie "Qualità"	171
Cartelli kit per cabina elettrica	146
Cartelli messa a terra	141
Cartelli multisimbolo	68-70
Cartelli norme e istruzioni	136-140
Cartelli "Obiettivo sicurezza"	135
Cartelli per aree verdi e tempo libero	166
Cartelli per cantieri temporanei	286,287
Cartelli per interni e aree private	154-156
Cartelli per riserve e divieti	165
Cartelli per trasporti	330-333
Cartelli personalizzati	20-21
Cartelli proprietà privata	158-163
Cartelli quadrifacciali	163
Cartelli raccolta differenziata	167
Cartelli sostanze pericolose	40-41
Cartelli stoccaggio rifiuti	40
Cartelli stradali di direzione	283,284,285
Cartelli stradali di divieto	278,289
Cartelli stradali di indicazione	283,284
Cartelli stradali di inizio/fine località	284,285
Cartelli stradali di pericolo	280
Cartelli stradali di precedenza	280
Cartelli stradali di obbligo	278,279
Cartelli stradali vari	282
Cartelli vari	128-132
Cartelli videosorveglianza	113,161,163,282
Cartelline e buste trasparenti	181-183
Cartellini di avvertimento	145
Cassette per manichette e naspi	463-464
Cassette portachiavi	178,465
Cassette portadocumenti	465
Cassette portaestintori	464,465
Cassettiere per tavoli da lavoro	231
Cassonetti portarifiuti	535-536
Catadiottri	325
Catene	133,296,299,300
Cavalletti portasegnaletica	287,290-291
Cavalletti bifacciali segnapericolo	205
CER (segnaletica)	165
Cerchi adesivi per pavimento	200-201
Cerotti	442
Cestini portarifiuti	523-525,533
Chiodi per delimitazione aree	325
Cime (funi)	295,468,473
Cinghie per barelle	446
Cintura ad alta visibilità	389
Cinture di posizionamento anticaduta	423
Cinture lombari	269
Cisternette	487
CLP (cartelli ed etichette)	39,122,124-127
Collante per delineatori	311
Collari semplici e doppi	292
Colonnine antisosta	307
Colonnine di delimitazione	192,296
Colonnine di delimitazione	297,299,301
Colonnine tendinastro	188-191,299,301
Colonnine luminose	294
Colorfix (segnaletica)	110-112
Componenti fotoluminescenti	84-91,150
Compressore	354
Coni segnaletici e accessori	300,310-311
Contentori multiuso	235-236
Contentori in lamiera per magazzini	238
Contentori per liquidi infiammabili	502-504
Contentori per pile esauste	498
Contentori per rifiuti speciali	498
Contentori per siringhe usate	445
Container	489,492-493
Contentori ribaltabili per rottami	496,497
Coperte antifiamma	480
Coperte per il primo soccorso	445,448,480
Coperte per la saldatura	381
Copertura di protezione	313
Coprigradini	256
Corde segnaletica	295
Corde	295,468,473
Cordone per colonnine	192

Cordini di posizionamento	423,426
Cordoli	309,317,319
Cornici	178,180,181,182,183,185
Cornici a cavalletto	185
Cornici a libro	183
Cornici per colonnine tendinastro	189,191
Cornici portacartelli	189,191,192,297
Crede di protezione per le mani	412,413
Croci di Sant'Andrea	279
Crystal (segnaletica)	100-103
Cuffie antirumore	362,363,366
Cuffie per elmetti	362,366,370
Cuffia per la saldatura	381
Cupole di sorveglianza	320
Custodie per D.P.I. e dispositivi medici	432
Custodia per guanti isolanti	427

D

Datario (bollini)	273
Design & System (cartelli)	95-112,190-192
Defibrillatore	447
Delimitatori (di parcheggi)	309,312,317,318
Delineatori di curva	285
Delineatori di ostacolo	294
Delineatori	285,294,309,311
Depositi di stoccaggio	488-493
Dime	212-213
Dieletrico (varie)	367,369,370,419,427
Direzione (inizio/fine località)	285
Direzione (senso unico)	284
Direzione (targhe varie)	285
Direzione (viabilità extraurbana)	284
Direzione (zone turistiche e urbane)	284,285
Disinfezione D.P.I.	432
Dispenser per igienizzanti	523
Dispositivi anticaduta retrattili	422,425
Dispositivi di fuga	351,354,355
Dispositivi di messa a terra	429
Dispositivi di tutela parcheggio	307-308
Dispositivi di segnalazione allarme	469
Dispositivo treppiedi di recupero	424-425
Dissuasori	295,319
Distributore di inserti/tappi auricolari	360,363
Divieto (segnali stradali di)	278,279
Divisori adesivi per pavimento	201,202
Docce e lavaocchi di emergenza	451-458
Dogparking (cartello)	163

E

Easyfix (cartelli)	120
Elmetti	365-370
Elmetti + cuffia (kit)	366,369,370
Elmetti V.V.F.	368,369
Espositori a pavimento (totem)	186-187
Espositori, portaposter	185,187
Esoscheletro	269
Estintori	327,460,461
Etichette per apparecchi laser	142
Etichette d'identificazione	270-272
Etichette di divieto	114
Etichette di indicazioni per interni	154-156
Etichette di obbligo	114
Etichette di pericolo	114-115
Etichette in lingua straniera	149,171
Etichette magnetiche	206
Etichette non rimovibili	115
Etichette per imballi	332,333
Etichette per impianti elettrici	142-145
Etichette per interni	154-155,170
Etichette per lay-out	143
Etichette per tubazioni (CLP)	124-127
Etichette trasporto merci pericolose	332-333
Evacuazione marittima (articoli)	473

F

Facciali filtranti	340-343
Fari da lavoro	246-248
Fascette autobloccanti in acciaio	292
Felpe, pile	384,385,388,390,391,392

Fermacapo per barelle	446
Fermaruota	317
Figura 398 del C.d.S. (cartello)	287
Film estensibile per imballi	204
Filtri per maschere	344-347,350
Fioretti isolanti	429
Fischietto	473
Fitosanitari (armadi)	499
Flabello	468
Fluo (primo soccorso)	435,436
Fold (cartelli bifacciali flessibili)	81,207
Forbici	443,445
Fotoluminescente (vedi Cartelli e Segnaletica)	
Fotovoltaico (cartelli, etichette)	33,69,131,143
Frecce per tubazioni	121,124-127
Frecce adesive per pavimento	200,201
Freccia direzionale luminosa	324
Fumogeni di emergenza	473
Funi	295,468,473

G

Gambali per boscaiolo	379
Ganasce di sicurezza	472
Ganci	296,299,300
Garza sterile	443
Generatore di aria calda	249
Gettacarta	524-526,528-530
Ghette	380,382
Ghiaccio istantaneo	443
Giacche, giubbotti	384-388,390-393
Giubbotto salvagente	473
Gilet ad alta visibilità	327,385,387,388
Gilet ATEX	388
Gilet da lavoro	387,390
Ginocchiere	268
G.P.L. depositi (cartelli)	141
Gomitiere	268
Grembiuli	380,382,406,411
Grigliati componibili	261
Guanti e accessori antitaglio	404-406
Guanti antivibranti	268
Guanti anticalore e per saldatura	406
Guanti dielettrici e per archi elettrici	383,427
Guanti rischio chimico	408-409
Guanti rischio meccanico	402-403
Guanti monouso	410-411

I-J-K

Idranti a muro	463
Igiene (prodotti per)	412-413,432,522,523
Imbracature anticaduta	421,424
Impianti a led	324
Indicazione (piena improvvisa)	285
Indicazione (pronto soccorso, ecc.)	283
Indumenti (vedi abbigliamento)	
Infermerie aziendali (attrezzature per)	449
Ingombro (segnalazioni veicoli)	330,331
Insegne	196
Inserti auricolari	360,361,363
Intimo (abbigliamento)	394
Jeans	392,393
Kit ADR	327,513
Kit cabine elettriche	146
Kit cavalletto per pronto intervento	290
Kit ustioni	435,441,448

L

Laminato in vetroresina	261
Lampade Atex e Rals	474-476
Lampade da lavoro	246-249
Lampade di emergenza (portatili)	326
Lampeggiatori omologati	250,326
Lance antincendio	464-466
Lastre frangibili	466
Lavagne scrivibili e accessori	179,185
Lavaocchi e docce di emergenza	451-458
Lavaocchi (kit e stazioni a parete)	451-458
Leggio	183,186
Lettere autoadesive	206-207

Leva di manovra antiscontilla	257
Levaschegge (kit)	441
Lettoni medici	449
Liquidi schiumogeni	462
Lockout/tagout	470-472
Lucchetti di sicurezza	470

M

Madia con cassette basculanti	235
Magnete per teli isolanti	428
Magliette	391
Maniche a vento	322
Manichette antitaglio	405
Manichette saldatura	380
Manichette antincendio (selle per)	465,466
Manicotti	380,389,398,399
Marcatori industriali (pennarelli)	244-245
Marker stradali	325
Maschere (rianimazione)	444
Maschere (saldatura)	431
Maschere (vie respiratorie)	344-349,352,355
Mascherine	340-343
Medicazioni e ausili di emergenza	442,443
Megafoni	467
Merci pericolose (etichette)	332-333
Messa a terra (dispositivi di)	429
Metal (segnaletica)	104-109
Metalsign (segnaletica modulare)	173
Misuratore stradale	326
Mini pittogrammi in rotolo	119
Monouso (tute e accessori)	396-399
Moschettoni anticaduta	422,425

N

Naspi	466
Nastri antiscivolo	253,254
Nastri per amianto	495
Nastri per imballi	203-204
Nastri segnaletici	199-202,253,330
Nastro in acciaio inox	292
Nastri in polietilene	202,203
Nastri in PVC	199,200
Nastro anti-effrazione	204
Nastro corrimano fotoluminescente	91
Navetta per manutenzione aerea	497
New Jersey	309
Numeri civici	285
Numeri autoadesivi per scaffalature	208-209
Numeri e lettere per capannoni	209

O

Obbligo (segnali stradali di)	279
Occhi di gatto	325
Occhiali protettivi vari	374-378,428
Over-Drum	486

P-Q

Pacchi reintegro presidi medici	436-439
Pala anticorrosione	323
Palette segnaletiche	295
Paletti	293,298,299,308
Pali tubolari	293
Paline geodetiche	293
Pallet in polietilene	232
Pallet (stoccaggio sostanze pericolose)	482
Pallone per la rianimazione	444
Panchine per esterni	521
Panchine per spogliatoio	519
Pannelli di delimitazione	294
Pannelli divisorii	193
Pannelli integrativi (per cartelli)	281
Pannelli per segnalare ostacoli	306
Pannello porta attrezzi	230
Pantaloni	381,383,384,387,388,391,392,393
Paracolpi	216-219,318
Paracolpi per banchine	318

Parka.....	386,387,391,393
Passaggi pedonali.....	200
Passerelle pedonali.....	318
Pattumiere.....	525,529-530
Pattumiere per differenziata.....	525,528-529,535
Pavimentazioni componibili.....	261,490
Pavimento scivoloso (segnali per).....	205
Pedane defaticanti.....	262-265
Pedana isolante.....	428
Pedane riscaldanti.....	266
Pellicole per vetri.....	274
Pellicola rifrangente per veicoli.....	330
Pennarelli.....	185,244,245
Pericolo (segnali stradali di).....	280
Pettorina (per boscaioli).....	379
Piantane (per defibrillatori ed estintori).....	447,462
Piastrelle tattili.....	301
Piastrine numerate.....	273
Picozzini.....	468
Picchetti.....	293
Pile, felpe.....	388,390,391,392
Pinza di raccolta.....	445
Pinza per sigilli.....	243
Pistola di marciaggio Safe In®.....	211
Pittogrammi adesivi per pavimenti.....	214
Pittogrammi in rotolo.....	119
Pittogrammi per superfici in vetro.....	113
Plexi (segnaletica).....	95-99
Plexicur (segnaletica).....	82,95
Pocket mask.....	444
Polietilene a bolle d'aria.....	232
Polionda (segnaletica in).....	288,289
Polo.....	388,391
Polsiere.....	268
Ponteggio.....	226
Portabiciclette.....	520
Portacarta (dispenser).....	522-523
Portadepliant.....	176,177,186
Portadocumenti per camion.....	334
Portaestintori.....	461,462,464
Portaetichette.....	181
Portanomi, portabadge.....	184
Portafogli.....	183
Portaplanimetrie (targa).....	180
Portaposter.....	185
Portasegnali.....	291
Portautensili.....	239
Posaceneri.....	505,524-527
Posaceneri autoestinguenti.....	505
Precedenza (segnali stradali di).....	280
Primo soccorso (kit di).....	435-441
Prodotti assorbenti Safe In®.....	508-514
Proiettori a led.....	249
Profili per delimitazione di aree.....	312,316,317
Profili rifrangenti.....	215
Proiettore da lavoro.....	249
Prolunga elettrica.....	249
Protezione da amianto.....	494,495
Protezione da rischi saldatura.....	380,381,406
Protezione da rischi saldatura.....	430,431
Protezione dall'elettricità.....	367,369,370
Protezione dall'elettricità.....	419,426-429
Protezione degli occhi e del viso.....	374-379
Protezione dei piedi.....	415-419,467
Protezione del capo.....	365-370
Protezione dell'udito.....	360-363
Protezione della cute.....	412,413
Protezione delle mani.....	402-413
Protezione delle vie respiratorie.....	340-357
Protezioni ergonomiche.....	268-269
Protezioni perimetrali per macchinari.....	258
Protezioni per scaffalature.....	216-219
Pulsanti manuali antincendio.....	469
Quadrilatero per chiusini.....	305,306

R

Raccolta batterie esauste.....	237,498
Raccolta differenziata (cartelli).....	167
Raccolta differenziata (contenitori).....	525,528-530
Rallentatori di velocità.....	312,313
Rampa di accesso.....	306,318

Rampe passacavi.....	314,315
Registro attrezzature antincendio.....	465
Reggia in plastica.....	232
Reti da cantiere.....	293
Retroriflettenti (per cassonetti).....	215
Rianimazione (articoli per la).....	444
Rianimatore bocca a bocca.....	444
Ricambi per idranti.....	465
Ricambi docce.....	454-455
Rifiuti sanitari pericolosi (contenitori).....	445
Rilevatore di fumo.....	469
Rilevatori di gas.....	357
Rilevatori di tensione.....	429
Rinfrescanti (articoli).....	395
Riscaldanti (articoli).....	395
Ripari (per mola, tornio e trapano).....	260
Rotoli antiscivolo.....	253
Rotonde stradali.....	319
Rottami (contenitori per).....	496,497
Rubinetto per idranti.....	465

S

Sacchetti in polietilene.....	233
Sacchetti igienici e per rifiuti sanitari.....	443,523
Sacchi zavorra.....	294
Sacchi portarifiuti.....	534
Saldatrice per sacchetti.....	233
Saldatura (articoli).....	380,381,407,430,431
Sale scioglineve.....	323
Salvagenti.....	473
Salviette disinfettanti.....	432
Scaffalature (per stoccaggio).....	488,490
Scale.....	226-229
Scale mobili e tappeti (cartelli).....	135
Scarpe (protettive da lavoro).....	415-418,467
Scioglimento ghiaccio (articoli per).....	323
Scritte adesive per pavimenti.....	214
Secchio per sabbia.....	466
Sedia portantina.....	445
Segnale libero/occupato.....	173
Segnaletica fotoluminescente.....	84-91,150
Segnali luminosi.....	324,325
Segnalatori luminosi.....	250,324,326
Segnalazione veicoli (dispositivi).....	328-331
Segnaletica d'ambiente (vedi Design & System).....	
Segnaletica a mezzaluna.....	167,215
Segnaletica da pavimento.....	198-202,214-215
Segnaletica orizzontale.....	210-213
Segnaletica per cantieri (polionda).....	288,289
Segnali (vedi Cartelli).....	
Segnali per pavimento (scritte varie).....	214
Sella salvamanichetta.....	465
Semafori a led da cantiere.....	324
Semimaschere.....	344,345,347,349,352
Senso unico.....	284
Separatore di corsie per piste ciclabili.....	319
Sequenziale a led.....	324
Serbatoio per camion.....	334
Sfigmomanometro.....	444
Sgabelli.....	229,449
Sigilli di sicurezza.....	242,243,465
Simboli adesivi da pavimento.....	214
Simboli per segnaletica.....	283,284
Sistemi di alimentazione d'aria.....	353,356,357
Sistemi di bloccaggio.....	471-473
Sistemi di fuga.....	351,352,354
Sistemi di illuminazione aree estese.....	249,476
Sistemi di marcatura Safe In®.....	210-211
Sistemi di protezione.....	222-225,256,258,259
Sistemi di protezione per macchine.....	260
Sistemi di segnaletica intercambiabile.....	173
Sistemi di movimentazione.....	489
Sistemi per la comunicazione visiva.....	174-177
Sistemi per la comunicazione visiva.....	181-183
Solette per scarpe da lavoro.....	417,418
Soluzione salina sterile.....	435,441,442
Sostanze pericolose (CLP).....	39,122,124-127
Sostegni mobili per cartelli e per pali.....	293
Sotto elmetti.....	395,398
Sovrascarpe Tyvek e TNT.....	398,399
Spazi confinati (articoli per).....	353,356,357

Specchi.....	320,321
Staffe.....	292
Stampante per etichette.....	472
Stivali antincendio.....	467
Stivali da lavoro.....	379,389,419,427,467
Stoccaggio (contenitori).....	498-505
Stoccaggio (sostanze pericolose).....	482-494
Strisce antiscivolo.....	254
Supporti (cavalletti, pali, basi).....	291-293
Supporti lombari.....	269
Supporti per estintori.....	461
Supporti per fusti.....	483,484,490
Supporti per nastri segnaletici.....	293

T

Tabella lavori.....	287,289
Taglierini di sicurezza.....	240-241
Taniche e contenitori.....	502-504
Tappeti antipolvere e pedonali.....	265,266
Tappeti defaticanti.....	262-265
Tappeti isolanti.....	428
Tappeti personalizzabili e sanificanti.....	267
Tappi auricolari.....	360,361,363
Targhe autogestibili Design & System.....	173
Targhe d'identificazione.....	271
Targhe murali e da banco.....	174,175,180
Targa segnanome.....	177
Targhe (viarie).....	284-285
Tasche portadepliant.....	176,177,182,186
Tavoli da lavoro.....	231
Telai per cassette basculanti.....	235
Teli e rotoli isolanti.....	428
Teli portaferiti.....	445
Tendalini segnaletici.....	287
Tende (per la saldatura).....	430,431
Tendinastro (colonnine).....	188,189
Tendireggia.....	232
Termometro.....	442
Testina tendinastro a muro Safe In®.....	190,191
Testina tendinastro per coni.....	191,299,310
Testine tendinastro.....	188-191,299
Torçe da lavoro.....	246-248,326,371
Torçe da lavoro.....	474,475,476
Torçe Atex antideflagranti.....	474,475,476
Torçe (da testa e per elmetti).....	371
Totem, espositori.....	186,187
Traccialinee Safe In®.....	210-211
Transenne.....	297,302,303
Transpallet.....	233
Trasporto merci pericolose.....	328-333
Trespole portarifiuti.....	534
Triangolo auto ferma.....	327
Tromba a gas.....	469
Tronchetti dielettrici.....	427
T-shirt.....	391
Tubazioni (manichette antincendio).....	464
Tubazioni (frecce, nastri in rotolo per).....	121
Tute.....	391,397,398,399
Tute da lavoro.....	391

U-V-W-Z

Valigette (pronto soccorso).....	435-441
Valvole (dispositivi di bloccaggio).....	471
Vasche (di raccolta).....	483-487,504
Ventilatore a turbina.....	249
Verificatori (per guanti dielettrici).....	427
Vernici (e accessori per) Safe In®.....	210-213
Vernice di sicurezza per viti.....	245
Vernice antiscivolo.....	256
Vetrofanie (etichette per).....	113
Vetroresina (laminato e grigliato in).....	261
Vetri (pellicole per).....	274
Videosorveglianza (segnaletica).....	113,161
Videosorveglianza (segnaletica).....	164,282
Vinile per stampanti.....	472
Visiere.....	365-370,379
Wall organizer.....	184
Zattera di salvataggio.....	473
Zoccoli da lavoro.....	417

COME RAGGIUNGERCI

6ª ROTATORIA

CARTELLI SEGNALATORI

5ª ROTATORIA

4ª ROTATORIA

3ª ROTATORIA

2ª ROTATORIA

1ª ROTATORIA

TANGENZIALE OVEST DI MILANO
USCITA 4 (BAGGIO/CUSAGO)

7ª ROTATORIA

DA MILANO

direzione Quartiere Baggio > via Zurigo
> via Perini > via Cusago > viale Europa > via Volta 1

DALLE AUTOSTRADE

Tangenziale Ovest uscita 4 (Baggio/Cusago)
> direzione via Cusago > viale Europa > via Volta 1

COME ORDINARE

SCEGLI IL METODO CHE PREFERISCI: CHIAMACI, SCRIVICI O EFFETTUA GLI ORDINI DIRETTAMENTE DAL NOSTRO SITO E-COMMERCE!



TELEFONO
02 90.39.90.01



E-MAIL
cs@cartelli.it
info@safein.it



WEB
www.cartelli.it
www.safein.it

CONDIZIONI GENERALI DI VENDITA

- CONSEGNA** - se non diversamente specificato, la consegna si intende pronta salvo venduto. I tempi di consegna sono indicativi; il loro mancato rispetto non può essere causa di azioni risarcitorie. L'aspetto cromatico dei prodotti presenti sul catalogo potrebbe non rappresentare con assoluta precisione il colore reale dei medesimi. Cartelli Segnalatori S.r.l. si riserva la possibilità di proporre alternative e sostituzioni che siano il più possibile simili sotto il profilo prestazionale a quelle visibili sul presente catalogo. Accordi diversi devono essere espressamente accettati da Cartelli Segnalatori S.r.l.
- DOCUMENTAZIONE** - Tutte le richieste di documentazione accessoria pertinente con la fornitura (esclusa quella a corredo dei prodotti) dovranno pervenire sin dalla prima richiesta di offerta prodotto/i (o dell'ordine se la prima non ha avuto luogo). Le richieste di documentazione dovranno essere complete di tutte le informazioni necessarie alla loro evasione. Qualsiasi richiesta ricevuta dopo la ricezione dell'ordine del cliente, sarà evasa solo se ancora possibile e nei tempi necessari. In nessun caso potrà essere considerata fonte di reclamo ovvero determinare un ritardo nei pagamenti convenuti nelle fasi precedenti del contratto. Cartelli Segnalatori S.r.l. si riserva di addebitare qualsiasi costo accessorio dovuto all'evasione della richiesta.
- RESA** - franco nostro magazzino di Cusago (MI).
- SPEDIZIONI** - salvo differente accordo, sono effettuate tramite corrieri con noi convenzionati. Per le spedizioni effettuate a servizio Postale, le spese saranno addebitate in fattura. I beni viaggiano a rischio dell'acquirente.

- TRASPORTO E CONSEGNA** - La merce viaggia a rischio del destinatario, consigliamo di controllare scrupolosamente il materiale all'arrivo del corriere. Qualora si riscontrassero danni all'imballo o al prodotto, nonché la mancanza di colli, DEVE ESSERE CONTESTATA IMMEDIATAMENTE al corriere mediante l'ACCETTAZIONE CON RISERVA SPECIFICA E FIRMA da riportare per iscritto con l'apposita dicitura: "Riserva di controllo per imballo non integro / danneggiato / pezzi mancanti ecc.", **specificando sul DDT di consegna del corriere (sia cartaceo che elettronico) le motivazioni di tale riserva**, risultando non sufficiente la mera apposizione del "timbro di riserva specifica".
- PAGAMENTI** - i pagamenti devono essere intestati a Cartelli Segnalatori S.r.l. Secondo gli accordi intercorsi possono essere:
 - Bonifico bancario a vista fattura con appoggio su: Monte dei Paschi di Siena - ag. 1195 Cusago (MI) IBAN: IT1500103033070000003347093
 - Contrassegno netto (per i nuovi clienti il pagamento si intende sempre alla consegna)In caso di ritardato pagamento alle scadenze pattuite decorreranno automaticamente, senza alcuna formale diffida di Cartelli Segnalatori S.r.l., interessi di mora calcolati secondo il tasso indicato dall'art.5 del D.Lgs 9 ottobre 2002 n.231, comprensivo della maggiorazione ivi prevista (saggio di interesse applicato dalla Banca Centrale Europea alle sue principali operazioni di rifinanziamento, maggiorato di otto punti percentuali).
- PREZZI** - i prezzi sono al netto di IVA. Cartelli Segnalatori S.r.l. si riserva di poter variare

prezzi, articoli e condizioni di vendita senza preavviso e in qualunque momento riportando, quando possibile, le eventuali modifiche nel nostro sito internet www.cartelli.it.

- DISEGNI** - eventuali disegni forniti dal committente non verranno restituiti. Telai serigrafici, stampi, matrici, pellicole e quant'altro resosi necessario per l'esecuzione della fornitura, rimarranno di esclusiva proprietà di Cartelli Segnalatori S.r.l., anche se il committente ha partecipato alle spese di allestimento ed impianto.
- RESPONSABILITÀ E RESI** - i reclami devono essere presentati entro otto giorni dal ricevimento della merce. Eventuali resi sono ritirati solo se in precedenza concordati ed accettati per iscritto. Fatti salvi i principi di responsabilità del produttore, Cartelli Segnalatori S.r.l., in caso di riconosciuta difettosità dei prodotti, risponde dell'importo stesso del bene. Analogamente Cartelli Segnalatori S.r.l. non si assume alcuna responsabilità per danni derivati da una impropria conservazione, custodia, commercializzazione od utilizzo dei prodotti forniti. Per i resi verrà applicata una ritenuta del 20% sul valore della merce resa, per spese di gestione.
- FORO COMPETENTE** - per ogni controversia è esclusivamente competente il Foro di Milano. La riproduzione anche parziale di disegni, foto e codici prodotti è severamente vietata se non preventivamente autorizzata. Immagini e caratteristiche tecniche dei prodotti non sono impegnativi e potranno essere variati in qualsiasi momento.



VOLUMINOSO/PESANTE:
ARTICOLO SOGGETTO
A COSTI AGGIUNTIVI



FRAGILE:
ARTICOLO SOGGETTO
A COSTI AGGIUNTIVI

CARTELLI SEGNALATORI
VIA A. VOLTA 1 - 20047 CUSAGO (MI)
P.IVA 07803080154



safe

for a safe industry

Cartelli
Segnalatori

VIA A. VOLTA, 1 - 20047 CUSAGO (MI)

TEL 02 90.39.90.01

WEB www.cartelli.it

MAIL cs@cartelli.it



ASSOCIATA

ASSOSISTEMA
SAFETY Produzione, Distribuzione
e Manutenzione di DPI

ASSO
SEGNALETICA

PREVENZIONE INCENDI ITALIA
cultura della prevenzione

aias

ASSOCIAZIONE ITALIANA
SEGNALETICA STRADALE



ASSOLOMBARDA
Confindustria Milano Monza e Brianza

FEDERATA



ANIMA

FEDERAZIONE DELLE ASSOCIAZIONI NAZIONALI
DELL'INDUSTRIA MECCANICA VARIA ED AFFINE



CONFINDUSTRIA

CERTIFICAZIONE DI SISTEMA

Member of CISQ Federation



CERTIFIED MANAGEMENT SYSTEM
ISO 9001



FEDERAZIONE

CISQ



THE INTERNATIONAL CERTIFICATION NETWORK

ISO 9001:2015 - CERTIFICATO N. 40211

CERTIFICAZIONE DI PRODOTTO



PRODOTTO CERTIFICATO
Regolamento (UE)
n. 305/2011

MEMBRO: GRUPPO DI LAVORO "SEGNALETICA" DELLA COMMISSIONE
DI SICUREZZA UNI (ENTE NAZIONALE ITALIANO DI UNIFICAZIONE)